

TC7MH595FK

8-Bit Shift Register/Latch (3-State)

The TC7MH595FK is an advanced high speed 8 bit shift register/latch fabricated with silicon gate C²MOS technology.

It achieves the high speed operation similar to equivalent bipolar schottky TTL while maintaining the CMOS low power dissipation.

The TC7MH595FK contains an 8 bit static shift register which feeds an 8 bit storage register.

Shift operation is accomplished on the positive going transition of the SCK input. The output register is loaded with the contents of the shift register on the positive going transition of the RCK input. Since RCK and SCK signals are independent, parallel outputs can be held stable during the shift operation. And, since the parallel outputs are 3-state, it can be directly connected to 8 bit bus. This register can be used in serial-to-parallel conversion, data receivers, etc.

An input protection circuit ensures that 0 to 5.5 V can be applied to the input pins without regard to the supply voltage. This device can be used to interface 5 V to 3 V systems and two supply systems such as battery back up. This circuit prevents device destruction due to mismatched supply and input voltages.

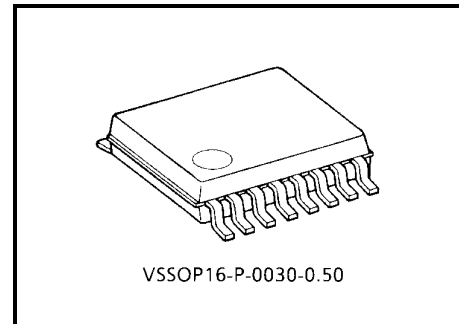

Weight: 0.02 g (typ.)

Features

- High speed: $f_{\max} = 185 \text{ MHz}$ (typ.) ($V_{CC} = 5 \text{ V}$)
- Low power dissipation: $I_{CC} = 4 \mu\text{A}$ (max) ($T_a = 25^\circ\text{C}$)
- High noise immunity: $V_{NIH} = V_{NIL} = 28\% V_{CC}$ (min)
- Power down protection is provided on all inputs.
- Balanced propagation delays: $t_{pLH} \approx t_{pHL}$
- Wide operating voltage range: $V_{CC}(\text{opr}) = 2\sim 5.5 \text{ V}$
- Low noise: $V_{OLP} = 1.0 \text{ V}$ (max)
- Pin and function compatible with 74ALS595

Pin Assignment (top view)

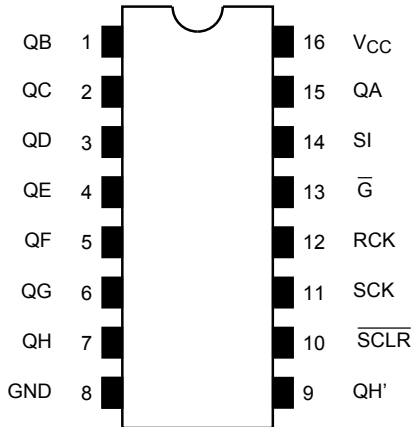

IEC Logic Symbol

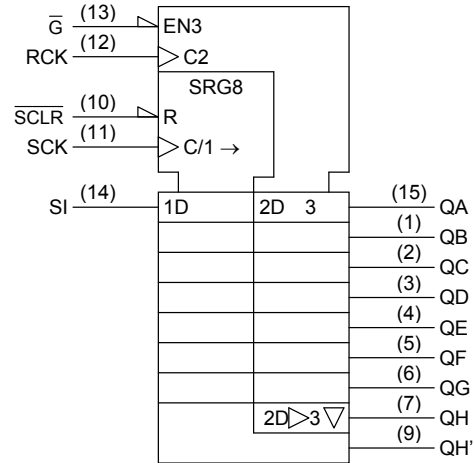

Truth Table

Inputs					Function
SI	SCK	SCLR	RCK	G-bar	
X	X	X	X	H	QA thru QH outputs disable
X	X	X	X	L	QA thru QH outputs enable
X	X	L	X	X	Shift register is cleared.
L		H	X	X	First stage of S.R. becomes "L". Other stages store the data of previous stage, respectively.
H		H	X	X	First stage of S.R. becomes "H". Other stages store the data of previous stage, respectively.
X		H	X	X	State of S.R. is not changed.
X	X	X		X	S.R. data is stored into storage register.
X	X	X		X	Storage register stage is not changed.

X: Don't care

Timing Chart

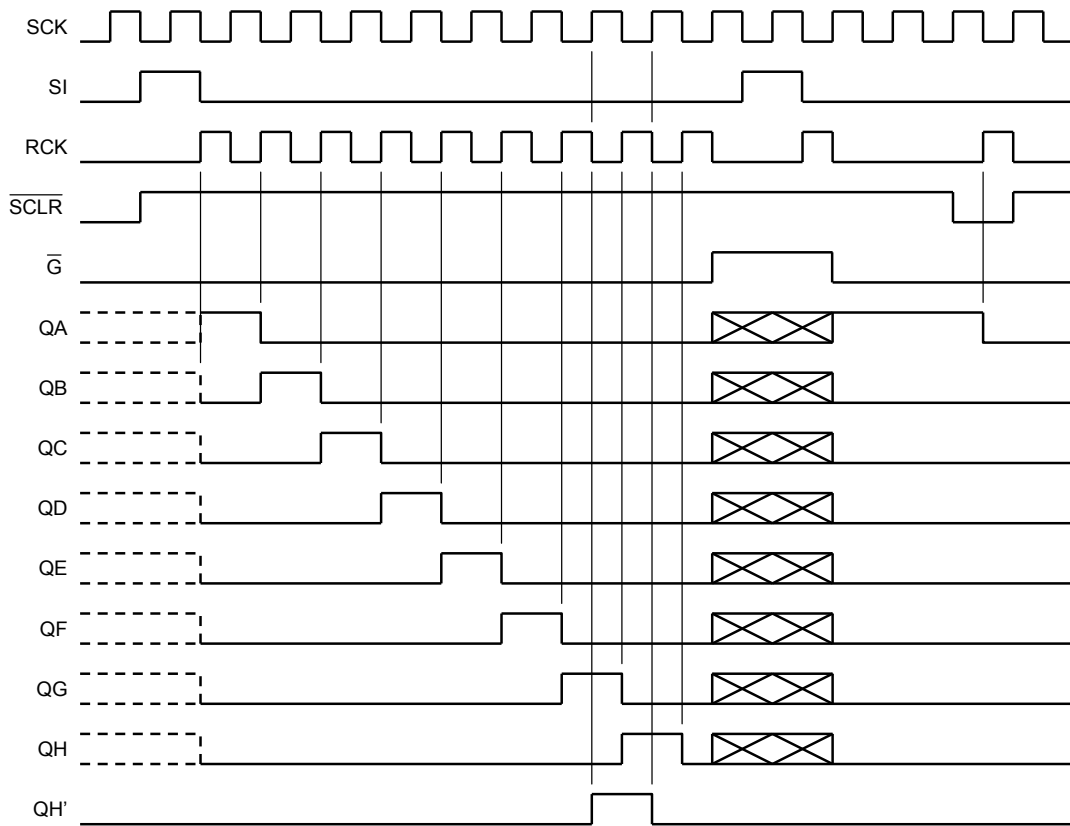

System Diagram

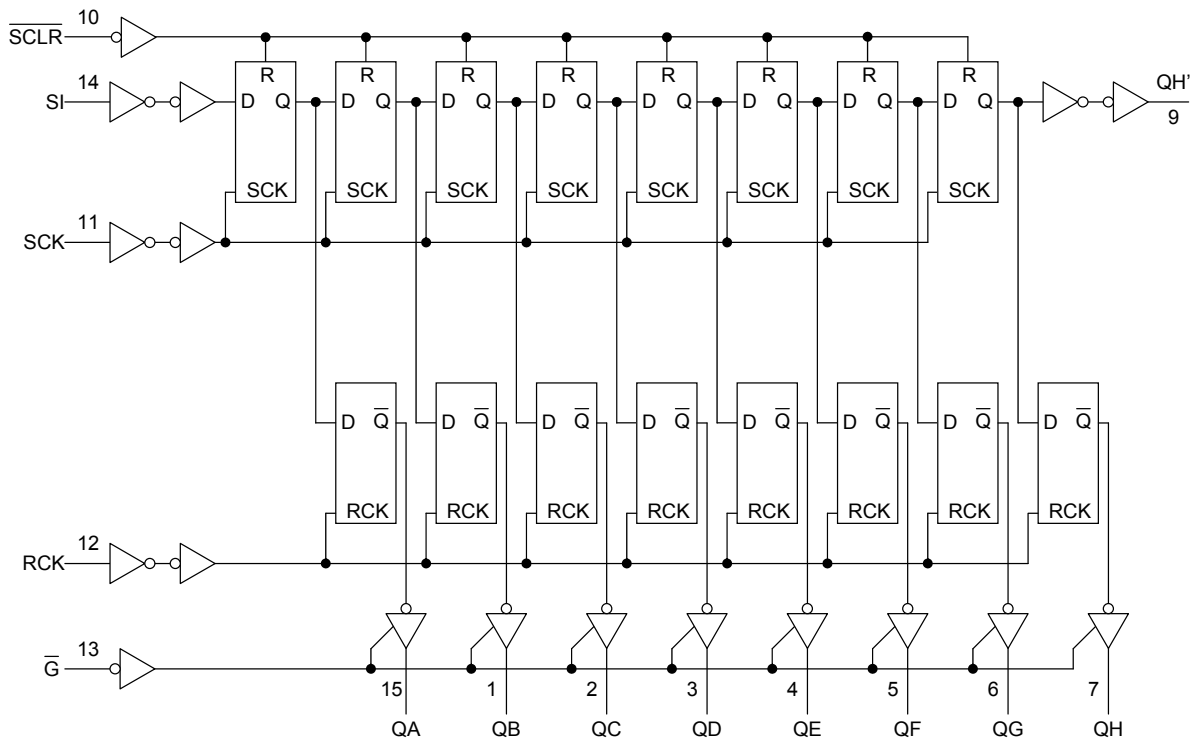

Absolute Maximum Ratings (Note)

Characteristics	Symbol	Rating	Unit
Supply voltage range	V_{CC}	-0.5~7.0	V
DC input voltage	V_{IN}	-0.5~7.0	V
DC output voltage	V_{OUT}	-0.5~ $V_{CC} + 0.5$	V
Input diode current	I_{IK}	-20	mA
Output diode current	I_{OK}	± 20	mA
DC output current	I_{OUT}	± 25	mA
DC V_{CC} /ground current	I_{CC}	± 75	mA
Power dissipation	P_D	180	mW
Storage temperature	T_{stg}	-65~150	$^{\circ}C$

Note: Exceeding any of the absolute maximum ratings, even briefly, lead to deterioration in IC performance or even destruction.

Using continuously under heavy loads (e.g. the application of high temperature/current/voltage and the significant change in temperature, etc.) may cause this product to decrease in the reliability significantly even if the operating conditions (i.e. operating temperature/current/voltage, etc.) are within the absolute maximum ratings and the operating ranges.

Please design the appropriate reliability upon reviewing the Toshiba Semiconductor Reliability Handbook ("Handling Precautions"/"Derating Concept and Methods") and individual reliability data (i.e. reliability test report and estimated failure rate, etc).

Operating Ranges (Note)

Characteristics	Symbol	Rating	Unit
Supply voltage	V_{CC}	2.0~5.5	V
Input voltage	V_{IN}	0~5.5	V
Output voltage	V_{OUT}	0~ V_{CC}	V
Operating temperature	T_{opr}	-40~85	$^{\circ}C$
Input rise and fall time	dt/dv	0~100 ($V_{CC} = 3.3 \pm 0.3$ V)	ns/V
		0~20 ($V_{CC} = 5 \pm 0.5$ V)	

Note: The operating ranges must be maintained to ensure the normal operation of the device.
Unused inputs must be tied to either VCC or GND.

Electrical Characteristics

DC Characteristics

Characteristics		Symbol	Test Condition	Ta = 25°C			Ta = -40~85°C		Unit					
				V _{CC} (V)	Min	Typ.	Max	Min		Max				
Input voltage	High level	V _{IH}	—	2.0	1.50	—	—	1.50	V					
				3.0~5.5	V _{CC} × 0.7	—	—	V _{CC} × 0.7		—				
	Low level	V _{IL}	—	2.0	—	—	0.50	—		0.50				
				3.0~5.5	—	—	V _{CC} × 0.3	—		V _{CC} × 0.3				
Output voltage	High level	V _{OH}	V _{IN} = V _{IH} or V _{IL}	I _{OH} = -50 μA	2.0	1.9	2.0	—	1.9	V				
					3.0	2.9	3.0	—	2.9		—			
				I _{OH} = -4 mA	3.0	2.58	—	—	2.48		—			
					4.5	3.94	—	—	3.80		—			
	Low level	V _{OL}	V _{IN} = V _{IH} or V _{IL}	I _{OL} = 50 μA	2.0	—	0	0.1	—		0.1			
					3.0	—	0	0.1	—		0.1			
				I _{OL} = 4 mA	3.0	—	—	0.36	—		0.44			
					4.5	—	—	0.36	—		0.44			
				3-state output off-state current	I _{OZ}	V _{IN} = V _{IH} or V _{IL} V _{OUT} = V _{CC} or GND	5.5	—	—		±0.25	—	±2.50	μA
							Input leakage current	I _{IN}	V _{IN} = 5.5 V or GND		0~5.5	—	—	±0.1
Quiescent supply current	I _{CC}	V _{IN} = V _{CC} or GND	5.5	—	—	4.0	—	40.0	μA					

Timing Requirements (Input: t_r = t_f = 3 ns)

Characteristics		Symbol	Test Condition	Ta = 25°C		Ta = -40~85°C		Unit
				V _{CC} (V)	Typ.	Limit	Limit	
Minimum pulse width (SCK, RCK)	t _w (H) t _w (L)	—	—	3.3 ± 0.3	—	5.0	5.0	ns
				5.0 ± 0.5	—	5.0	5.0	
Minimum pulse width ($\overline{\text{SCLR}}$)	t _w (L)	—	—	3.3 ± 0.3	—	5.0	5.0	ns
				5.0 ± 0.5	—	5.0	5.0	
Minimum set-up time (SI-SCK)	t _s	—	—	3.3 ± 0.3	—	3.5	3.5	ns
				5.0 ± 0.5	—	3.0	3.0	
Minimum set-up time (SCK-RCK)	t _s	—	—	3.3 ± 0.3	—	8.0	8.5	ns
				5.0 ± 0.5	—	5.0	5.0	
Minimum set-up time ($\overline{\text{SCLR}}$ -RCK)	t _s	—	—	3.3 ± 0.3	—	8.0	9.0	ns
				5.0 ± 0.5	—	5.0	5.0	
Minimum hold time (SI-SCK)	t _h	—	—	3.3 ± 0.3	—	1.5	1.5	ns
				5.0 ± 0.5	—	2.0	2.0	
Minimum hold time (SCK-RCK, $\overline{\text{SCLR}}$ -RCK)	t _h	—	—	3.3 ± 0.3	—	0	0	ns
				5.0 ± 0.5	—	0	0	
Minimum removal time ($\overline{\text{SCLR}}$)	t _{rem}	—	—	3.3 ± 0.3	—	3.0	3.0	ns
				5.0 ± 0.5	—	2.5	2.5	

AC Characteristics (Input: $t_r = t_f = 3 \text{ ns}$)

Characteristics	Symbol	Test Condition			Ta = 25°C			Ta = -40~85°C		Unit
			VCC (V)	CL (pF)	Min	Typ.	Max	Min	Max	
Propagation delay time (SCK-QH')	t_{pLH} t_{pHL}	—	3.3 ± 0.3	15	—	8.8	13.0	1.0	15.0	ns
				50	—	11.3	16.5	1.0	18.5	
			5.0 ± 0.5	15	—	6.2	8.2	1.0	9.4	
				50	—	7.7	10.2	1.0	11.4	
Propagation delay time (SCLR-QH')	t_{pHL}	—	3.3 ± 0.3	15	—	8.4	12.8	1.0	13.7	ns
				50	—	10.9	16.3	1.0	17.2	
			5.0 ± 0.5	15	—	5.9	8.0	1.0	9.1	
				50	—	7.4	10.0	1.0	11.1	
Propagation delay time (RCK-Qn)	t_{pLH} t_{pHL}	—	3.3 ± 0.3	15	—	7.7	11.9	1.0	13.5	ns
				50	—	10.2	15.4	1.0	17.0	
			5.0 ± 0.5	15	—	5.4	7.4	1.0	8.5	
				50	—	6.9	9.4	1.0	10.5	
Output enable time	t_{pZL} t_{pZH}	RL = 1 kΩ	3.3 ± 0.3	15	—	7.5	11.5	1.0	13.5	ns
				50	—	9.0	15.0	1.0	17.0	
			5.0 ± 0.5	15	—	4.8	8.6	1.0	10.0	
				50	—	8.3	10.6	1.0	12.0	
Output disable time	t_{pLZ} t_{pHZ}	RL = 1 kΩ	3.3 ± 0.3	50	—	12.1	15.7	1.0	16.2	ns
			5.0 ± 0.5	50	—	7.6	10.3	1.0	11.0	
Maximum clock frequency	fmax	—	3.3 ± 0.3	15	80	150	—	70	—	MHz
				50	55	130	—	50	—	
			5.0 ± 0.5	15	135	185	—	115	—	
				50	95	155	—	85	—	
Input capacitance	CIN	—	—	—	4	10	—	10	pF	
Output capacitance	COU	—	—	—	6	—	—	—	pF	
Power dissipation capacitance	CPD		(Note)	—	87	—	—	—	pF	

Note: CPD is defined as the value of the internal equivalent capacitance which is calculated from the operating current consumption without load.

Average operating current can be obtained by the equation:

$$I_{CC(opr)} = C_{PD} \cdot V_{CC} \cdot f_{IN} + I_{CC}$$

Noise Characteristics (Input: $t_r = t_f = 3 \text{ ns}$)

Characteristics	Symbol	Test Condition	Ta = 25°C			Unit
			V _{CC} (V)	Typ.	Limit	
Quiet output maximum dynamic V _{OL}	V _{OLP}	C _L = 50 pF	5.0	0.8	1.0	V
Quiet output minimum dynamic V _{OL}	V _{OLV}	C _L = 50 pF	5.0	-0.8	-1.0	V
Minimum high level dynamic input voltage V _{IH}	V _{IHD}	C _L = 50 pF	5.0	—	3.5	V
Maximum low level dynamic input voltage V _{IL}	V _{ILD}	C _L = 50 pF	5.0	—	1.5	V

Input Equivalent Circuit

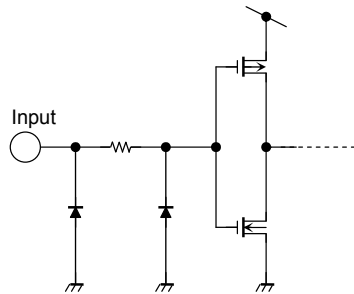

Package Dimensions

VSSOP16-P-0030-0.50

Unit : mm

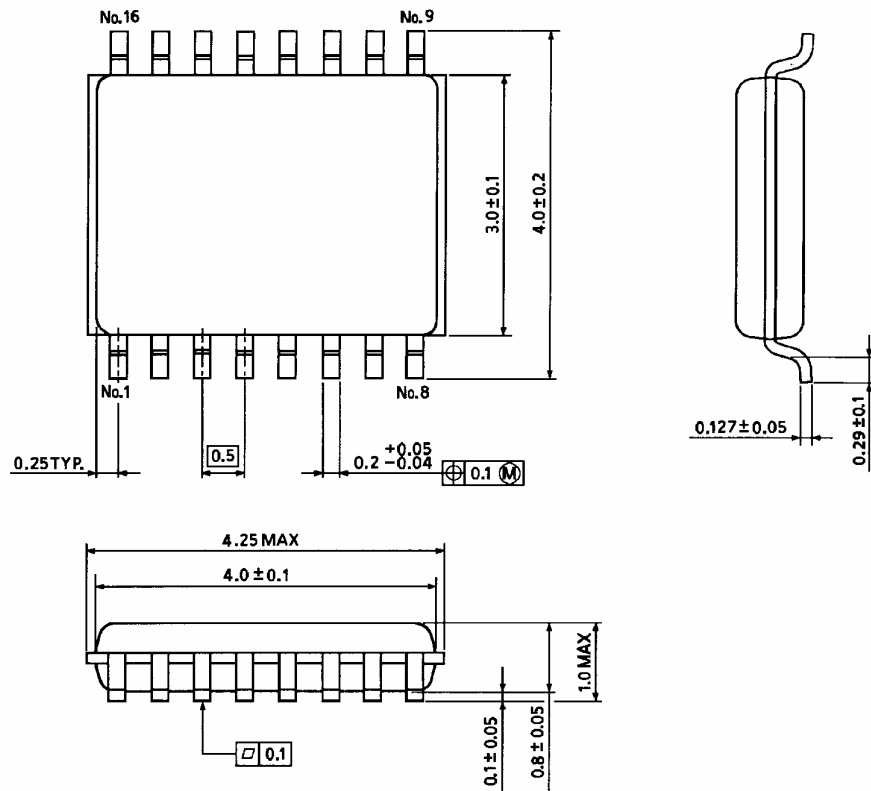

Weight: 0.02 g (typ.)

RESTRICTIONS ON PRODUCT USE

20070701-EN GENERAL

- The information contained herein is subject to change without notice.
- TOSHIBA is continually working to improve the quality and reliability of its products. Nevertheless, semiconductor devices in general can malfunction or fail due to their inherent electrical sensitivity and vulnerability to physical stress. It is the responsibility of the buyer, when utilizing TOSHIBA products, to comply with the standards of safety in making a safe design for the entire system, and to avoid situations in which a malfunction or failure of such TOSHIBA products could cause loss of human life, bodily injury or damage to property.
In developing your designs, please ensure that TOSHIBA products are used within specified operating ranges as set forth in the most recent TOSHIBA products specifications. Also, please keep in mind the precautions and conditions set forth in the "Handling Guide for Semiconductor Devices," or "TOSHIBA Semiconductor Reliability Handbook" etc.
- The TOSHIBA products listed in this document are intended for usage in general electronics applications (computer, personal equipment, office equipment, measuring equipment, industrial robotics, domestic appliances, etc.). These TOSHIBA products are neither intended nor warranted for usage in equipment that requires extraordinarily high quality and/or reliability or a malfunction or failure of which may cause loss of human life or bodily injury ("Unintended Usage"). Unintended Usage include atomic energy control instruments, airplane or spaceship instruments, transportation instruments, traffic signal instruments, combustion control instruments, medical instruments, all types of safety devices, etc.. Unintended Usage of TOSHIBA products listed in this document shall be made at the customer's own risk.
- The products described in this document shall not be used or embedded to any downstream products of which manufacture, use and/or sale are prohibited under any applicable laws and regulations.
- The information contained herein is presented only as a guide for the applications of our products. No responsibility is assumed by TOSHIBA for any infringements of patents or other rights of the third parties which may result from its use. No license is granted by implication or otherwise under any patents or other rights of TOSHIBA or the third parties.
- Please contact your sales representative for product-by-product details in this document regarding RoHS compatibility. Please use these products in this document in compliance with all applicable laws and regulations that regulate the inclusion or use of controlled substances. Toshiba assumes no liability for damage or losses occurring as a result of noncompliance with applicable laws and regulations.