

Dual N-Channel 20-V (D-S) MOSFET with Schottky Diode

PRODUCT SUMMARY				
	V _{DS}	R _{DS(on)} (Ω)	I _D (A) ^{a, f}	Q _g (Typ.)
Channel-1	20	0.022 at V _{GS} = 10 V	8.0	8
		0.025 at V _{GS} = 4.5 V	8.0	
Channel-2	20	0.015 at V _{GS} = 10 V	8.0	17
		0.019 at V _{GS} = 4.5 V	8.0	

SCHOTTKY PRODUCT SUMMARY		
V _{DS} (V)	V _{SD} (V) Diode Forward Voltage	I _F (A) ^a
20	0.43 V at 1.0 A	4.0

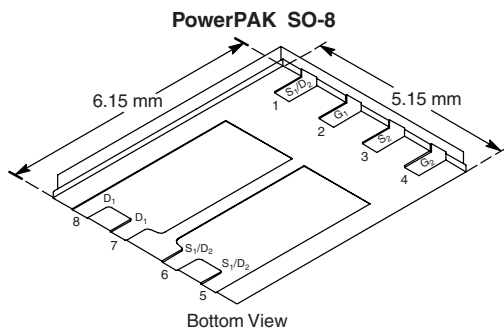

Ordering Information: Si7980DP-T1-E3 (Lead (Pb)-free)
Si7980DP-T1-GE3 (Lead (Pb)-free and Halogen-free)

FEATURES

- Halogen-free According to IEC 61249-2-21 Available
- TrenchFET[®] Power MOSFET
- 100 % R_g and UIS Tested



RoHS
COMPLIANT
HALOGEN
FREE
Available

APPLICATIONS

- Synchronous Buck Converter
 - Game Machines
 - Notebook Computers

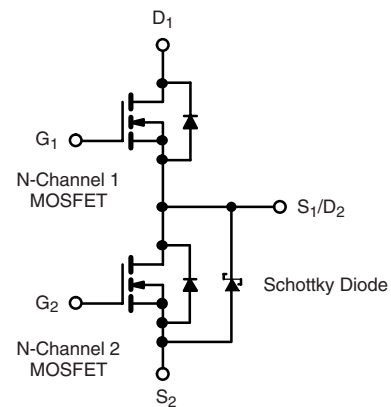

ABSOLUTE MAXIMUM RATINGS T _A = 25 °C, unless otherwise noted				
Parameter	Symbol	Channel-1	Channel-2	Unit
Drain-Source Voltage	V _{DS}	20	20	V
Gate-Source Voltage	V _{GS}	± 16	± 16	
Continuous Drain Current (T _J = 150 °C)	I _D	T _C = 25 °C	8 ^f	A
		T _C = 70 °C	8 ^f	
		T _A = 25 °C	8.8 ^{b, c}	
		T _A = 70 °C	7.1 ^{b, c}	
Pulsed Drain Current	I _{DM}	30	30	A
Source-Drain Current Diode Current	I _S	T _C = 25 °C	8 ^f	
		T _A = 25 °C	2.8 ^{b, c}	
Pulsed Source-Drain Current	I _{SM}	30	30	A
Single Pulse Avalanche Current	I _{AS}	15	15	
Single Pulse Avalanche Energy	E _{AS}	11.2	11.2	mJ
Maximum Power Dissipation	P _D	T _C = 25 °C	19.8	W
		T _C = 70 °C	12.6	
		T _A = 25 °C	3.1 ^{b, c}	
		T _A = 70 °C	2.0 ^{b, c}	
Operating Junction and Storage Temperature Range	T _J , T _{stg}	- 55 to 150		°C
Soldering Recommendations (Peak Temperature) ^{d, e}		260		

Notes:

- Based on T_C = 25 °C.
- Surface Mounted on 1" x 1" FR4 board.
- t = 10 s.
- See Solder Profile (www.vishay.com/ppg?73257). The PowerPAK SO-8 is a leadless package. The end of the lead terminal is exposed copper (not plated) as a result of the singulation process in manufacturing. A solder fillet at the exposed copper tip cannot be guaranteed and is not required to ensure adequate bottom side solder interconnection.
- Rework Conditions: manual soldering with a soldering iron is not recommended for leadless components.
- Package limited.

THERMAL RESISTANCE RATINGS

Parameter	Symbol	Channel-1		Channel-2		Unit	
		Typ.	Max.	Typ.	Max.		
Maximum Junction-to-Ambient ^{a, b}	$t \leq 10 \text{ s}$	R_{thJA}	32	40	30	36	°C/W
Maximum Junction-to-Case (Drain)	Steady State	R_{thJC}	5.0	6.3	4.5	5.7	

SPECIFICATIONS $T_J = 25 \text{ }^\circ\text{C}$, unless otherwise noted

Parameter	Symbol	Test Conditions	Min.	Typ. ^c	Max.	Unit	
Static							
Drain-Source Breakdown Voltage	V_{DS}	$V_{GS} = 0 \text{ V}, I_D = 250 \text{ } \mu\text{A}$	Ch-1	20		V	
		$V_{GS} = 0 \text{ V}, I_D = 1 \text{ mA}$	Ch-2	20			
V_{DS} Temperature Coefficient	$\Delta V_{DS}/T_J$	$I_D = 250 \text{ } \mu\text{A}$	Ch-1		22	mV/°C	
$V_{GS(th)}$ Temperature Coefficient	$\Delta V_{GS(th)}/T_J$	$I_D = 250 \text{ } \mu\text{A}$	Ch-1		- 5		
Gate Threshold Voltage	$V_{GS(th)}$	$V_{DS} = V_{GS}, I_D = 250 \text{ } \mu\text{A}$	Ch-1	1		2.5	V
		$V_{DS} = V_{GS}, I_D = 1 \text{ mA}$	Ch-2	1.4		2.8	
Gate-Body Leakage	I_{GSS}	$V_{DS} = 0 \text{ V}, V_{GS} = \pm 16 \text{ V}$	Ch-1			100	nA
		$V_{DS} = 0 \text{ V}, V_{GS} = \pm 16 \text{ V}$	Ch-2			100	
Zero Gate Voltage Drain Current	I_{DSS}	$V_{DS} = 20 \text{ V}, V_{GS} = 0 \text{ V}$	Ch-1			0.001	mA
		$V_{DS} = 20 \text{ V}, V_{GS} = 0 \text{ V}$	Ch-2		0.05	0.5	
		$V_{DS} = 20 \text{ V}, V_{GS} = 0 \text{ V}, T_J = 100 \text{ }^\circ\text{C}$	Ch-1			0.025	
		$V_{DS} = 20 \text{ V}, V_{GS} = 0 \text{ V}, T_J = 100 \text{ }^\circ\text{C}$	Ch-2		3	15	
On-State Drain Current ^d	$I_{D(on)}$	$V_{DS} = 5 \text{ V}, V_{GS} = 10 \text{ V}$	Ch-1	10		A	
		$V_{DS} = 5 \text{ V}, V_{GS} = 10 \text{ V}$	Ch-2	10			
Drain-Source On-State Resistance ^d	$R_{DS(on)}$	$V_{GS} = 10 \text{ V}, I_D = 5 \text{ A}$	Ch-1		0.018	0.022	Ω
		$V_{GS} = 10 \text{ V}, I_D = 5 \text{ A}$	Ch-2		0.012	0.015	
		$V_{GS} = 4.5 \text{ V}, I_D = 4 \text{ A}$	Ch-1		0.020	0.025	
		$V_{GS} = 4.5 \text{ V}, I_D = 4 \text{ A}$	Ch-2		0.015	0.019	
Forward Transconductance ^d	g_{fs}	$V_{DS} = 15 \text{ V}, I_D = 5 \text{ A}$	Ch-1		40	S	
		$V_{DS} = 15 \text{ V}, I_D = 5 \text{ A}$	Ch-2		47		
Dynamic^c							
Input Capacitance	C_{iss}	Channel-1 $V_{DS} = 10 \text{ V}, V_{GS} = 0 \text{ V}, f = 1 \text{ MHz}$	Ch-1		1010	pF	
			Ch-2		1370		
Output Capacitance	C_{oss}		Channel-2	Ch-1			220
			Ch-2		320		
Reverse Transfer Capacitance	C_{rss}	Channel-2 $V_{DS} = 10 \text{ V}, V_{GS} = 0 \text{ V}, f = 1 \text{ MHz}$	Ch-1		100		
			Ch-2		120		

Notes:

- Surface Mounted on 1" x 1" FR4 board.
- Maximum under Steady State conditions is 88 °C/W (Channel-1) and 83 °C/W (Channel-2).
- Guaranteed by design, not subject to production testing.
- Pulse test; pulse width $\leq 300 \text{ } \mu\text{s}$, duty cycle $\leq 2 \%$.



SPECIFICATIONS $T_J = 25\text{ }^\circ\text{C}$, unless otherwise noted							
Parameter	Symbol	Test Conditions	Min.	Typ. ^a	Max.	Unit	
Dynamic^a							
Total Gate Charge	Q_g	$V_{DS} = 10\text{ V}, V_{GS} = 10\text{ V}, I_D = 5\text{ A}$	Ch-1		17.5	27	nC
		$V_{DS} = 10\text{ V}, V_{GS} = 10\text{ V}, I_D = 5\text{ A}$	Ch-2		22.5	34	
		Channel-1 $V_{DS} = 10\text{ V}, V_{GS} = 4.5\text{ V}, I_D = 5\text{ A}$	Ch-1		8	12	
			Ch-2		10.3	16	
Gate-Source Charge	Q_{gs}	Channel-2 $V_{DS} = 10\text{ V}, V_{GS} = 4.5\text{ V}, I_D = 5\text{ A}$	Ch-1		2.5		
Gate-Drain Charge	Q_{gd}		Ch-2		3.4		
Gate Resistance	R_g	$f = 1\text{ MHz}$	Ch-1	0.2	1.1	2.2	Ω
			Ch-2	0.2	1.3	2.6	
Turn-On Delay Time	$t_{d(on)}$	Channel-1 $V_{DD} = 10\text{ V}, R_L = 2\text{ }\Omega$ $I_D \cong 5\text{ A}, V_{GEN} = 10\text{ V}, R_g = 1\text{ }\Omega$	Ch-1		9	18	ns
Rise Time	t_r		Ch-2		13	25	
Turn-Off Delay Time	$t_{d(off)}$	Channel-2 $V_{DD} = 10\text{ V}, R_L = 2\text{ }\Omega$ $I_D \cong 5\text{ A}, V_{GEN} = 10\text{ V}, R_g = 1\text{ }\Omega$	Ch-1		16	30	
			Ch-2		16	30	
Fall Time	t_f	Channel-1 $V_{DD} = 10\text{ V}, R_L = 2\text{ }\Omega$ $I_D \cong 5\text{ A}, V_{GEN} = 10\text{ V}, R_g = 1\text{ }\Omega$	Ch-1		20	35	
			Ch-2		24	45	
Turn-On Delay Time	$t_{d(on)}$	Channel-2 $V_{DD} = 10\text{ V}, R_L = 2\text{ }\Omega$ $I_D \cong 5\text{ A}, V_{GEN} = 10\text{ V}, R_g = 1\text{ }\Omega$	Ch-1		9	18	
			Ch-2		8	16	
Rise Time	t_r	Channel-1 $V_{DD} = 10\text{ V}, R_L = 2\text{ }\Omega$ $I_D \cong 5\text{ A}, V_{GEN} = 4.5\text{ V}, R_g = 1\text{ }\Omega$	Ch-1		15	30	
			Ch-2		18	35	
Turn-Off Delay Time	$t_{d(off)}$	Channel-2 $V_{DD} = 10\text{ V}, R_L = 2\text{ }\Omega$ $I_D \cong 5\text{ A}, V_{GEN} = 4.5\text{ V}, R_g = 1\text{ }\Omega$	Ch-1		18	35	
			Ch-2		18	35	
Fall Time	t_f	Channel-1 $V_{DD} = 10\text{ V}, R_L = 2\text{ }\Omega$ $I_D \cong 5\text{ A}, V_{GEN} = 4.5\text{ V}, R_g = 1\text{ }\Omega$	Ch-1		20	40	
			Ch-2		25	45	
Fall Time	t_f	Channel-2 $V_{DD} = 10\text{ V}, R_L = 2\text{ }\Omega$ $I_D \cong 5\text{ A}, V_{GEN} = 4.5\text{ V}, R_g = 1\text{ }\Omega$	Ch-1		12	24	
			Ch-2		10	20	
Drain-Source Body Diode Characteristics							
Continuous Source-Drain Diode Current	I_S	$T_C = 25\text{ }^\circ\text{C}$	Ch-1			8	A
			Ch-2			8	
Pulse Diode Forward Current ^a	I_{SM}		Ch-1			30	
			Ch-2			30	
Body Diode Voltage	V_{SD}	$I_S = 2\text{ A}$	Ch-1		0.73	1.1	V
		$I_S = 1\text{ A}$	Ch-2		0.37	0.43	
Body Diode Reverse Recovery Time	t_{rr}		Ch-1		16	32	ns
			Ch-2		20	40	
Body Diode Reverse Recovery Charge	Q_{rr}	Channel-1 $I_F = 5\text{ A}, dI/dt = 100\text{ A}/\mu\text{s}, T_J = 25\text{ }^\circ\text{C}$	Ch-1		8	16	nC
			Ch-2		10	20	
Reverse Recovery Fall Time	t_a	Channel-2 $I_F = 5\text{ A}, dI/dt = 100\text{ A}/\mu\text{s}, T_J = 25\text{ }^\circ\text{C}$	Ch-1		8		ns
			Ch-2		9		
Reverse Recovery Rise Time	t_b		Ch-1		8		
			Ch-2		11		

Notes:

a. Guaranteed by design, not subject to production testing.

Stresses beyond those listed under "Absolute Maximum Ratings" may cause permanent damage to the device. These are stress ratings only, and functional operation of the device at these or any other conditions beyond those indicated in the operational sections of the specifications is not implied. Exposure to absolute maximum rating conditions for extended periods may affect device reliability.

CHANNEL-1 TYPICAL CHARACTERISTICS 25 °C, unless otherwise noted

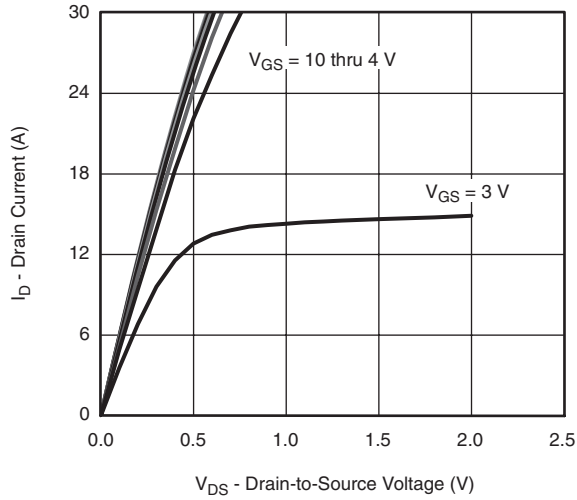

Output Characteristics

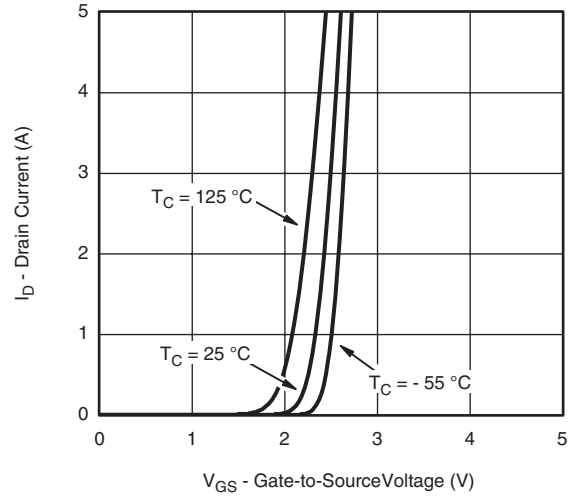

Transfer Characteristics

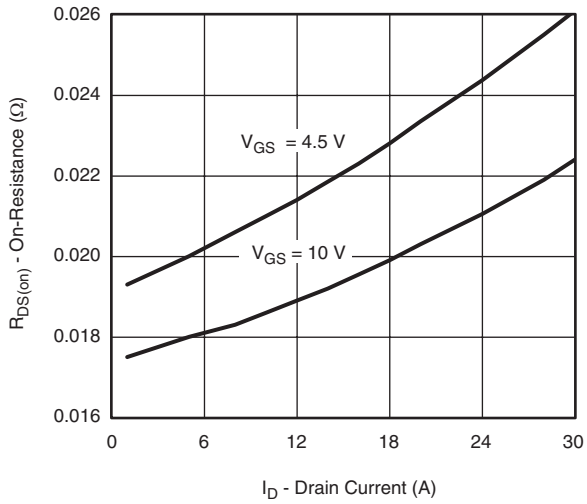

On-Resistance vs. Drain Current

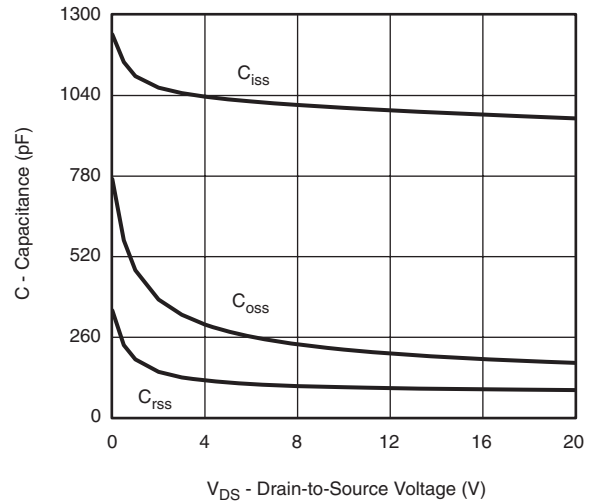

Capacitance

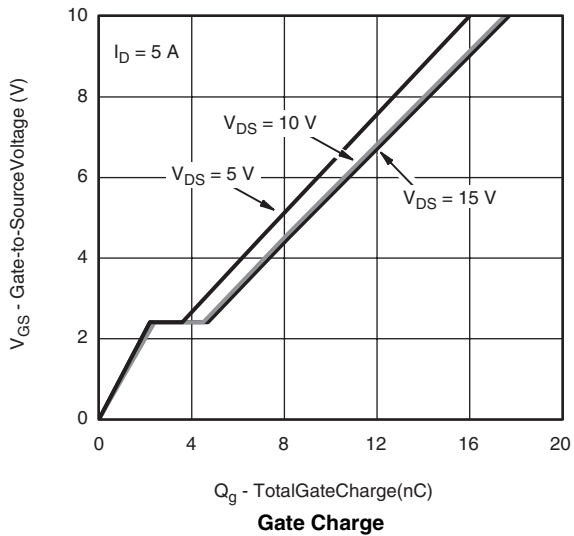

Gate Charge

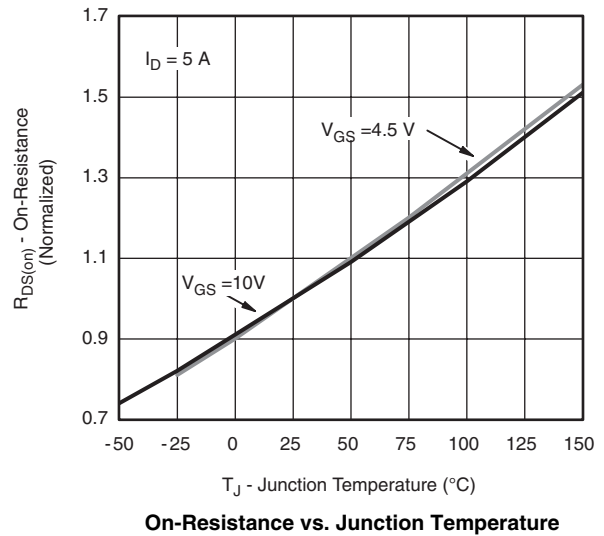

On-Resistance vs. Junction Temperature

CHANNEL-1 TYPICAL CHARACTERISTICS 25 °C, unless otherwise noted

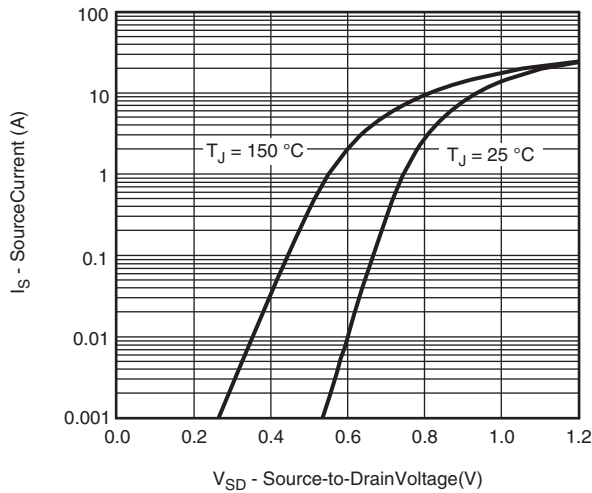

Source-Drain Diode Forward Voltage

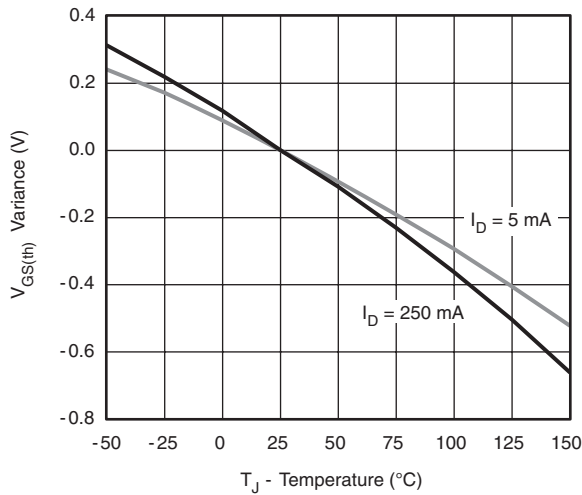

Threshold Voltage

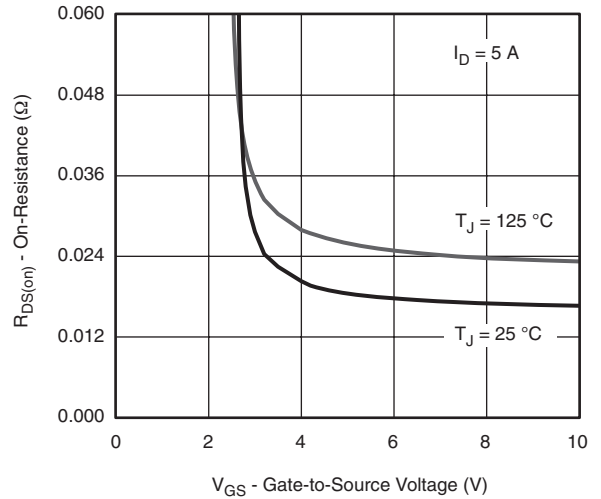

On-Resistance vs. Gate-to-Source Voltage

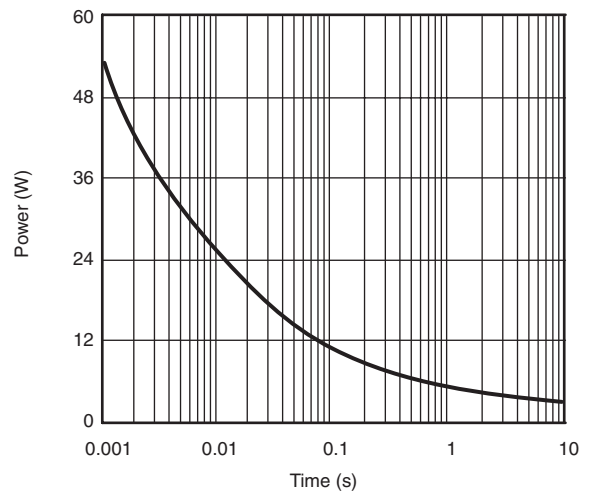

Single Pulse Power, Junction-to-Ambient

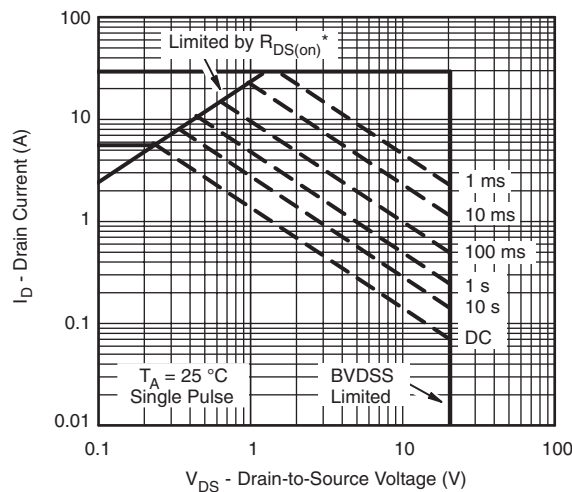

* $V_{GS} >$ minimum V_{GS} at which $R_{DS(on)}$ is specified

Safe Operating Area, Junction-to-Ambient

CHANNEL-1 TYPICAL CHARACTERISTICS 25 °C, unless otherwise noted

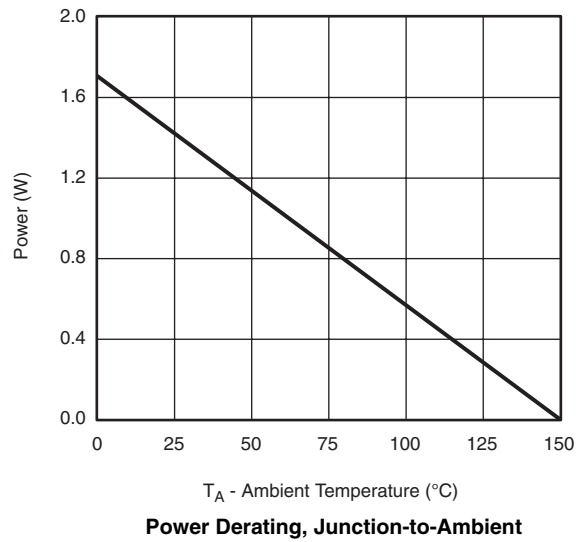
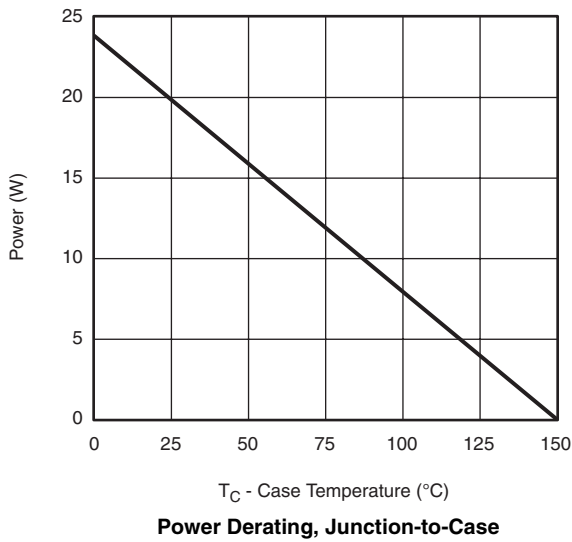
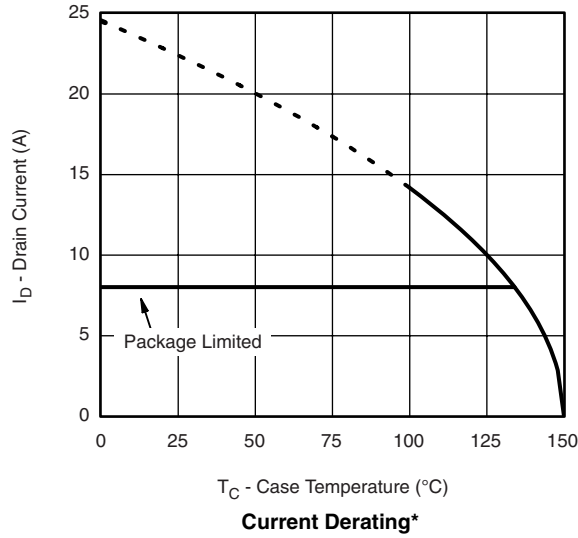

* The power dissipation P_D is based on $T_{J(max)} = 150$ °C, using junction-to-case thermal resistance, and is more useful in settling the upper dissipation limit for cases where additional heatsinking is used. It is used to determine the current rating, when this rating falls below the package limit.

CHANNEL-1 TYPICAL CHARACTERISTICS 25 °C, unless otherwise noted

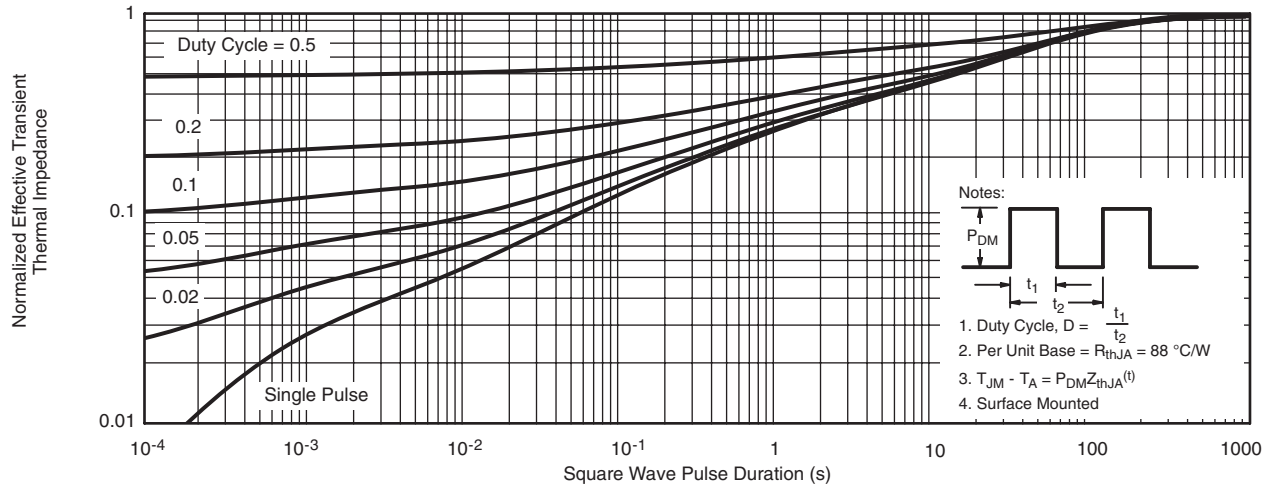

Normalized Thermal Transient Impedance, Junction-to-Ambient

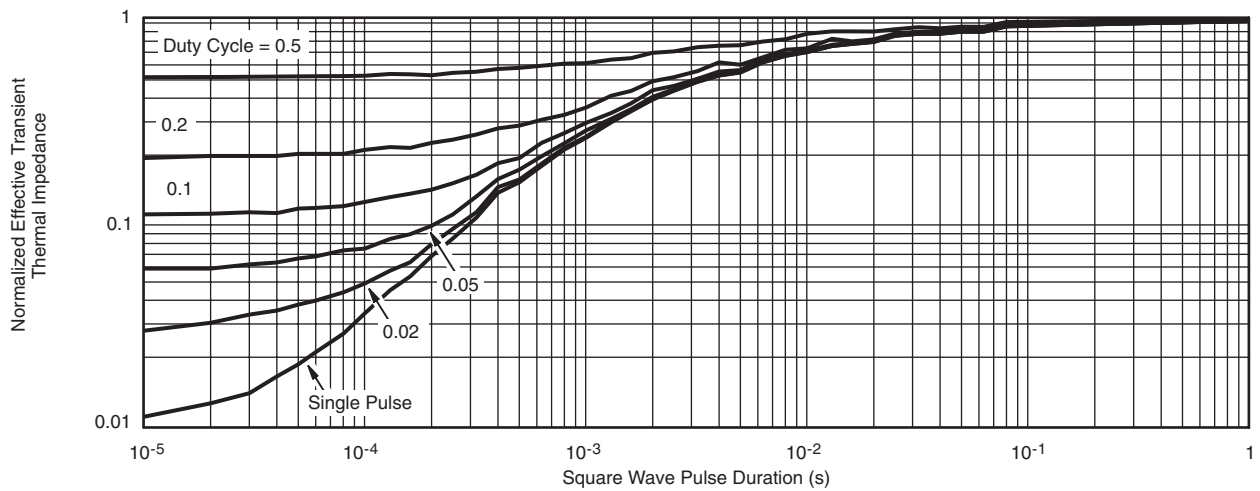

Normalized Thermal Transient Impedance, Junction-to-Case

CHANNEL-2 TYPICAL CHARACTERISTICS 25 °C, unless otherwise noted

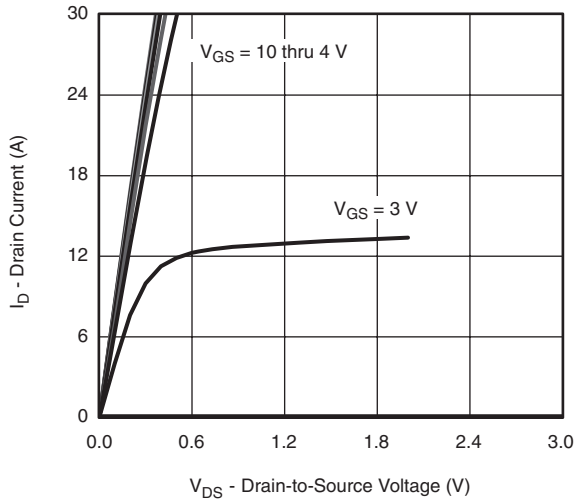

Output Characteristics

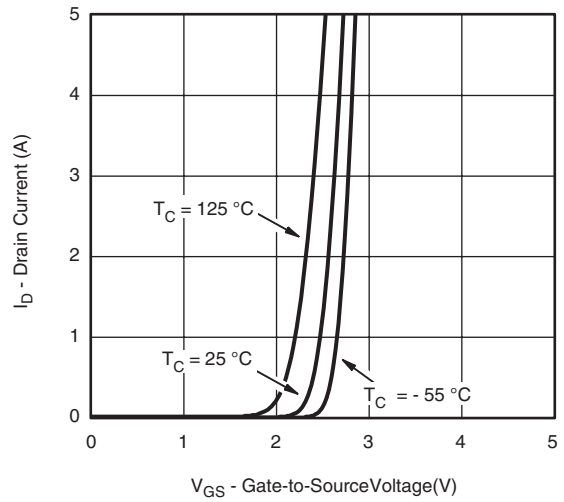

Transfer Characteristics

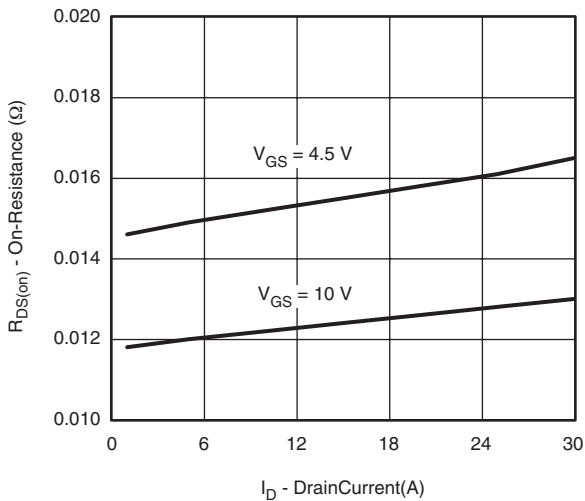

On-Resistance vs. Drain Current

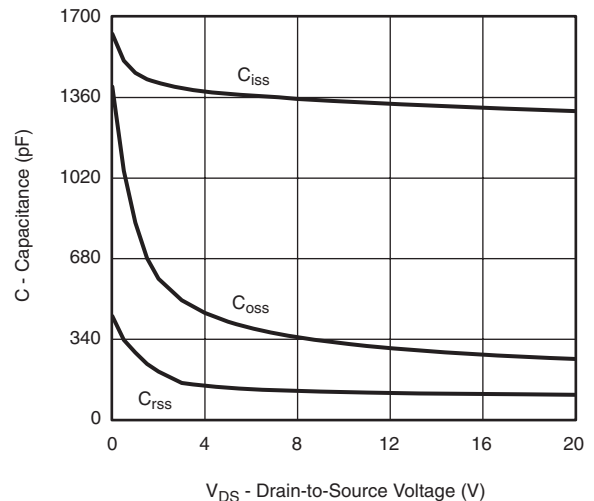

Capacitance

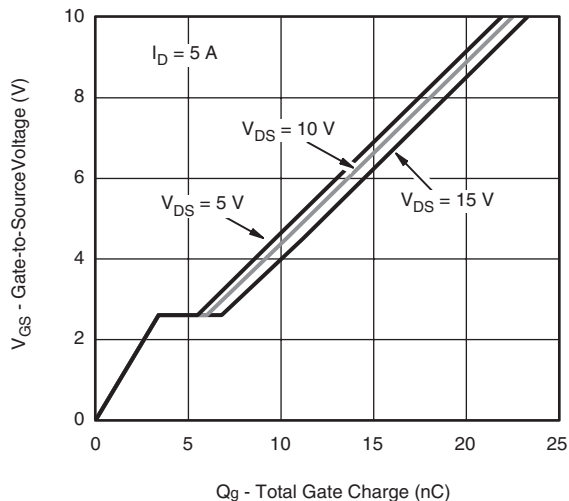

Gate Charge

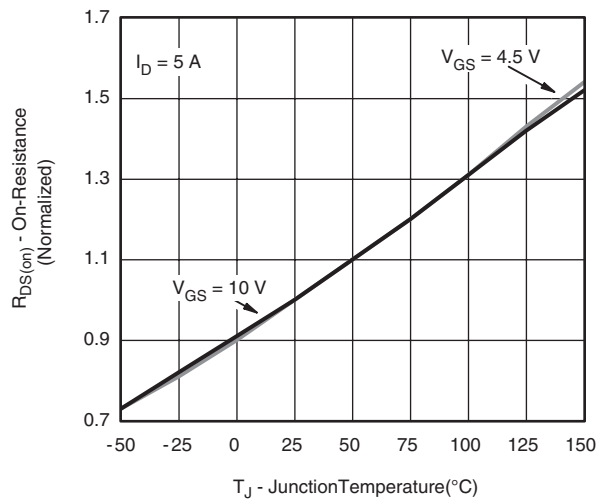

On-Resistance vs. Junction Temperature

CHANNEL-2 TYPICAL CHARACTERISTICS 25 °C, unless otherwise noted

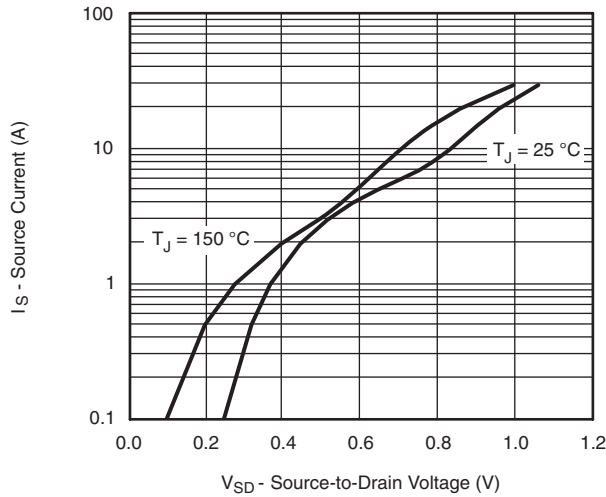

Source-Drain Diode Forward Voltage

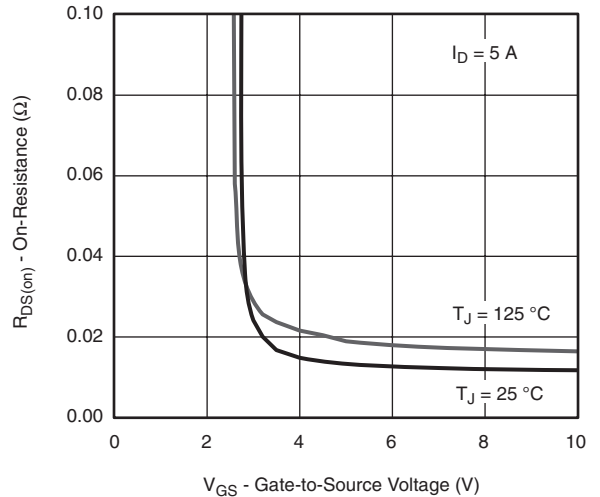

On-Resistance vs. Gate-to-Source Voltage

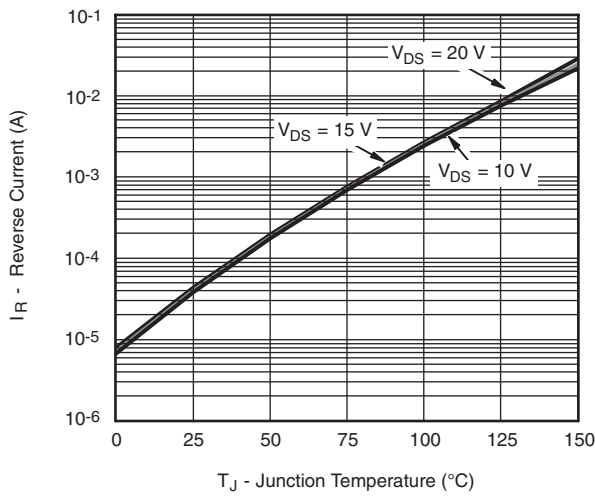

Reverse Current (Schottky)

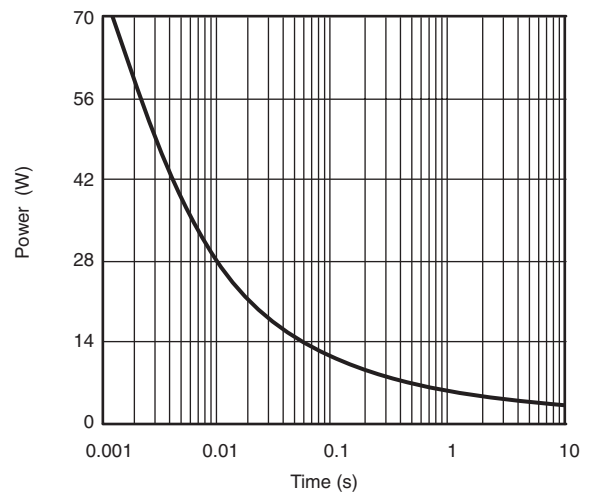

Single Pulse Power, Junction-to-Ambient

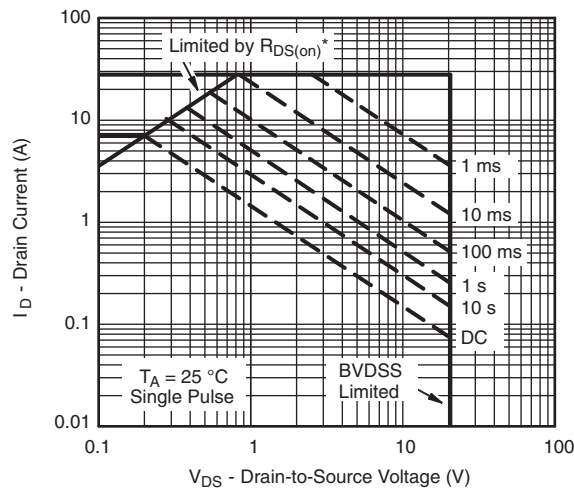

* $V_{GS} >$ minimum V_{GS} at which $R_{DS(on)}$ is specified

Safe Operating Area, Junction-to-Ambient

CHANNEL-2 TYPICAL CHARACTERISTICS 25 °C, unless otherwise noted

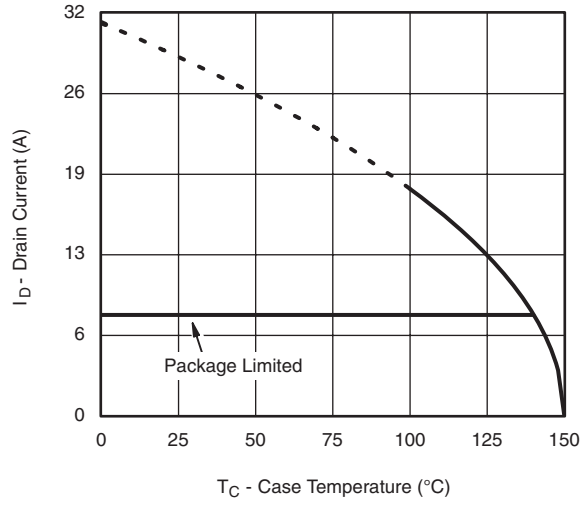

Current Derating*

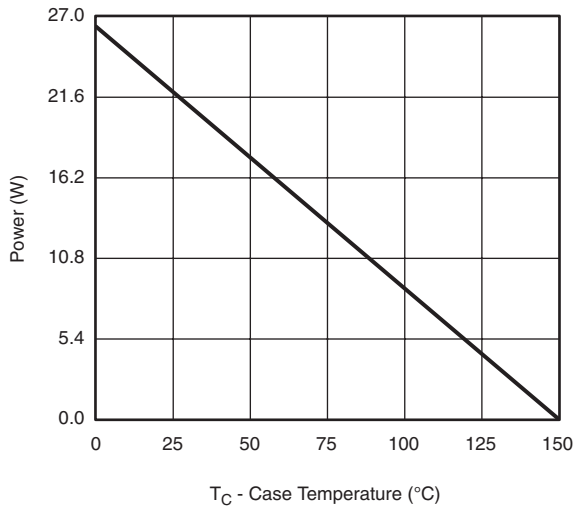

Power Derating, Junction-to-Case

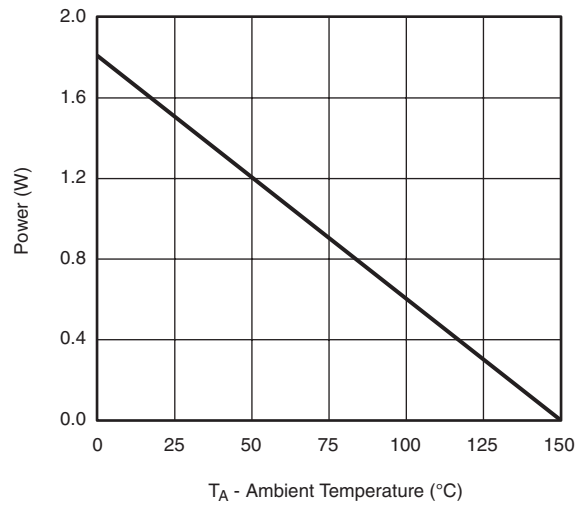

Power Derating, Junction-to-Ambient

* The power dissipation P_D is based on $T_{J(max)} = 150$ °C, using junction-to-case thermal resistance, and is more useful in settling the upper dissipation limit for cases where additional heatsinking is used. It is used to determine the current rating, when this rating falls below the package limit.

CHANNEL-2 TYPICAL CHARACTERISTICS 25 °C, unless otherwise noted

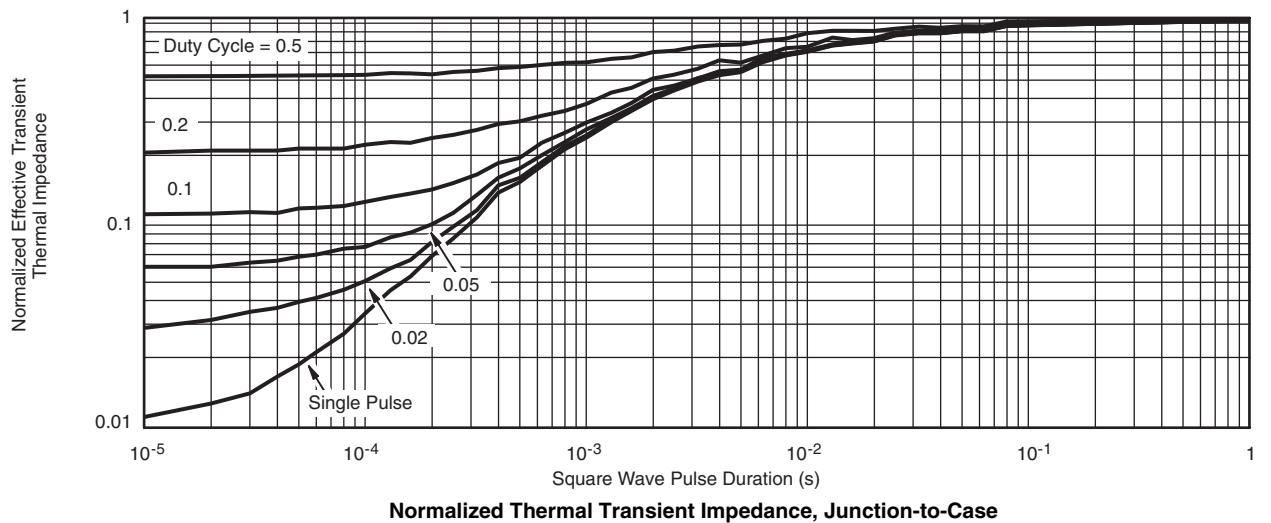
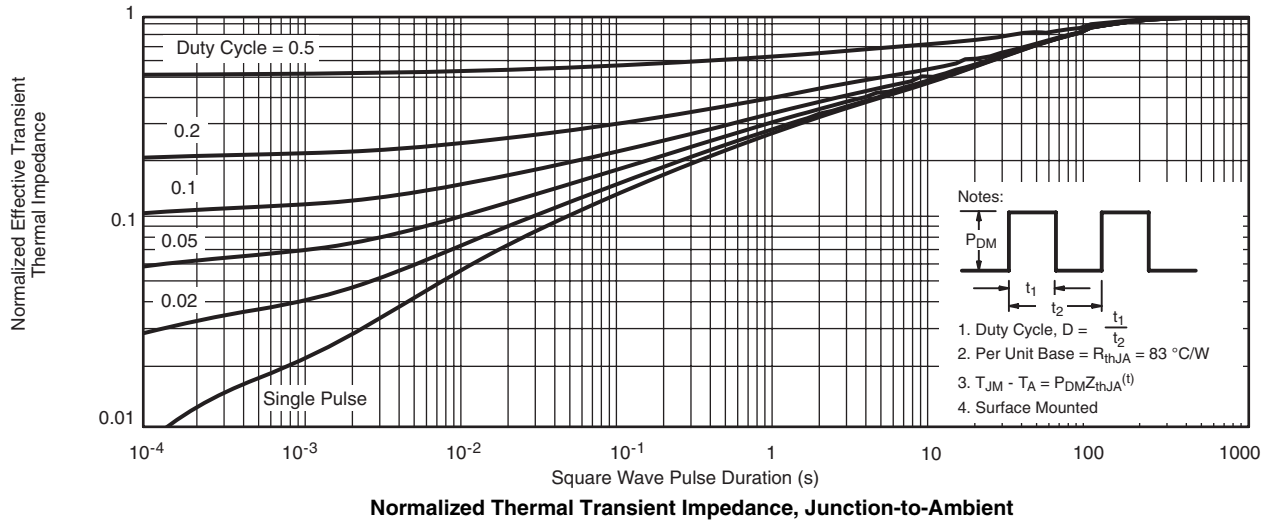

Vishay Siliconix maintains worldwide manufacturing capability. Products may be manufactured at one of several qualified locations. Reliability data for Silicon Technology and Package Reliability represent a composite of all qualified locations. For related documents such as package/tape drawings, part marking, and reliability data, see www.vishay.com/ppg?68391.



Disclaimer

All product specifications and data are subject to change without notice.

Vishay Intertechnology, Inc., its affiliates, agents, and employees, and all persons acting on its or their behalf (collectively, "Vishay"), disclaim any and all liability for any errors, inaccuracies or incompleteness contained herein or in any other disclosure relating to any product.

Vishay disclaims any and all liability arising out of the use or application of any product described herein or of any information provided herein to the maximum extent permitted by law. The product specifications do not expand or otherwise modify Vishay's terms and conditions of purchase, including but not limited to the warranty expressed therein, which apply to these products.

No license, express or implied, by estoppel or otherwise, to any intellectual property rights is granted by this document or by any conduct of Vishay.

The products shown herein are not designed for use in medical, life-saving, or life-sustaining applications unless otherwise expressly indicated. Customers using or selling Vishay products not expressly indicated for use in such applications do so entirely at their own risk and agree to fully indemnify Vishay for any damages arising or resulting from such use or sale. Please contact authorized Vishay personnel to obtain written terms and conditions regarding products designed for such applications.

Product names and markings noted herein may be trademarks of their respective owners.