

ZXMHC10A07T8

COMPLEMENTARY 100V ENHANCEMENT MODE MOSFET H-BRIDGE

SUMMARY

N-Channel = $V_{(BR)DSS} = 100V$; $R_{DS(on)} = 0.7\Omega$; $I_D = 1.4A$
 P-Channel = $V_{(BR)DSS} = -100V$; $R_{DS(on)} = 1.0\Omega$; $I_D = -1.3A$

DESCRIPTION

This new generation of trench MOSFETs from Zetex utilizes a unique structure that combines the benefits of low on-resistance with fast switching speed. This makes them ideal for high efficiency, low voltage, power management applications.

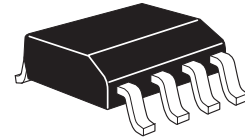

SM8

FEATURES

- Low on-resistance
- Fast switching speed
- Low threshold
- Low gate drive
- Single SM-8 Surface Mount Package

APPLICATIONS

- Single Phase DC Fan Motor Drive

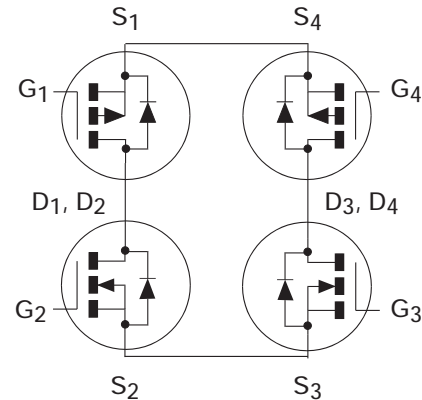

ORDERING INFORMATION

DEVICE	REEL SIZE	TAPE WIDTH	QUANTITY PER REEL
ZXMHC10A07T8TA	7"	12mm	1000 units
ZXMHC10A07T8TC	13"	12mm	4000 units

PINOUT

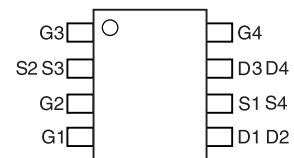

DEVICE MARKING

- ZXMH
C10A7

ZXMHC10A07T8

ABSOLUTE MAXIMUM RATINGS

PARAMETER	SYMBOL	N-channel	P-channel	UNIT
Drain-Source Voltage	V_{DSS}	100	-100	V
Gate-Source Voltage	V_{GS}	± 20	± 20	V
Continuous Drain Current @ $V_{GS}=10V$; $T_A=25^\circ C$ (b) (d) @ $V_{GS}=10V$; $T_A=70^\circ C$ (b) (d) @ $V_{GS}=10V$; $T_A=25^\circ C$ (a) (d)	I_D	1.1	-0.9	A
		0.9	-0.8	A
		1.0	-0.8	A
Pulsed Drain Current (c)	I_{DM}	5.2	-4.5	A
Continuous Source Current (Body Diode) (b)	I_S	2.3	-2.2	A
Pulsed Source Current (Body Diode) (c)	I_{SM}	5.2	-4.5	A
Power Dissipation at $T_A=25^\circ C$ (a) (d)	P_D	1.3		W
Linear Derating Factor		10.4		mW/ $^\circ C$
Power Dissipation at $T_A=25^\circ C$ (b) (d)	P_D	1.3		W
Linear Derating Factor		10.4		mW/ $^\circ C$
Operating and Storage Temperature Range	T_j, T_{stg}	-55 to +150		$^\circ C$

THERMAL RESISTANCE

PARAMETER	SYMBOL	VALUE	UNIT
Junction to Ambient (a) (d)	$R_{\theta JA}$	94.5	$^\circ C/W$
Junction to Ambient (b) (d)	$R_{\theta JA}$	73.3	$^\circ C/W$

NOTES

- (a) For a device surface mounted on 50mm x 50mm x 1.6mm FR4 PCB with high coverage of single sided 2oz copper, in still air conditions, with the heat sink split into two equal areas one for each drain connection.
- (b) For a device surface mounted on FR4 PCB measured at $t \leq 10$ sec.
- (c) Repetitive rating on 50mm x 50mm x 1.6mm FR4 PCB, $D=0.02$, pulse width = 300 μs - pulse width limited by maximum junction temperature. Refer to transient thermal impedance graph.
- (d) For device with one active die.

ZXMHC10A07T8

TYPICAL CHARACTERISTICS

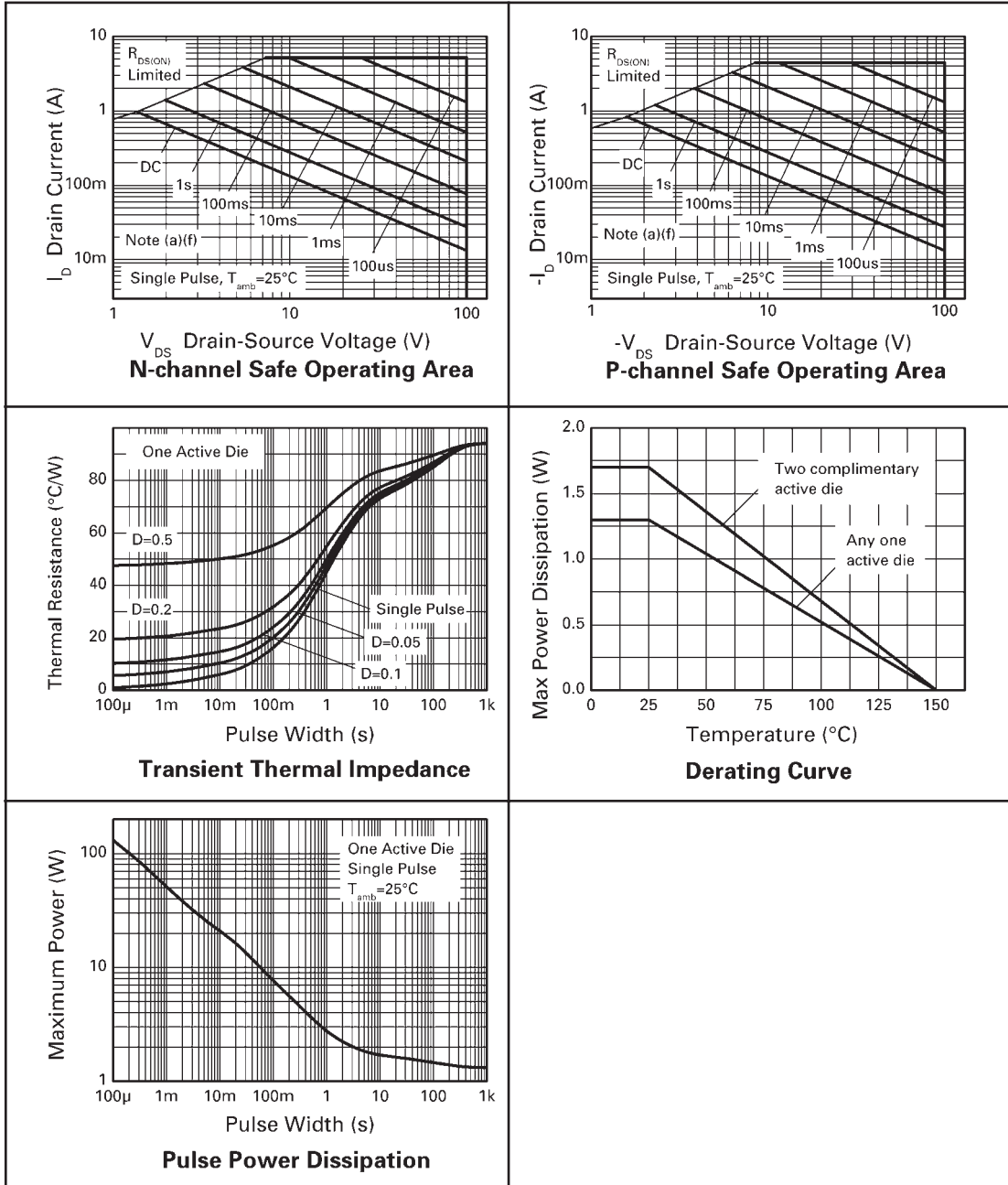

ZXMHC10A07T8

N-Channel

ELECTRICAL CHARACTERISTICS (at $T_{amb} = 25^{\circ}\text{C}$ unless otherwise stated)

PARAMETER	SYMBOL	MIN.	TYP.	MAX.	UNIT	CONDITIONS
STATIC						
Drain-Source Breakdown Voltage	$V_{(BR)DSS}$	100			V	$I_D = 250\mu\text{A}$, $V_{GS} = 0\text{V}$
Zero Gate Voltage Drain Current	I_{DSS}			1	μA	$V_{DS} = 100\text{V}$, $V_{GS} = 0\text{V}$
Gate-Body Leakage	I_{GSS}			100	nA	$V_{GS} = \pm 20\text{V}$, $V_{DS} = 0\text{V}$
Gate-Source Threshold Voltage	$V_{GS(th)}$	2.0		4.0	V	$I_D = 250\mu\text{A}$, $V_{DS} = V_{GS}$
Static Drain-Source On-State Resistance ⁽¹⁾	$R_{DS(on)}$			0.7 0.9	Ω	$V_{GS} = 10\text{V}$, $I_D = 1.5\text{A}$ $V_{GS} = 6\text{V}$, $I_D = 1.0\text{A}$
Forward Transconductance ^{(1) (3)}	g_{fs}		1.6		S	$V_{DS} = 15\text{V}$, $I_D = 1.0\text{A}$
DYNAMIC ⁽³⁾						
Input Capacitance	C_{iss}		138		pF	$V_{DS} = 60\text{V}$, $V_{GS} = 0\text{V}$ $f = 1\text{MHz}$
Output Capacitance	C_{oss}		12		pF	
Reverse Transfer Capacitance	C_{rss}		6		pF	
SWITCHING ^{(2) (3)}						
Turn-On-Delay Time	$t_{d(on)}$		1.8		ns	$V_{DD} = 50\text{V}$, $I_D = 1.0\text{A}$ $R_G \equiv 6.0\Omega$, $V_{GS} = 10\text{V}$
Rise Time	t_r		1.5		ns	
Turn-Off Delay Time	$t_{d(off)}$		4.1		ns	
Fall Time	t_f		2.1		ns	$V_{DS} = 50\text{V}$, $V_{GS} = 10\text{V}$ $I_D = 1.0\text{A}$
Total Gate Charge	Q_g		2.9		nC	
Gate-Source Charge	Q_{gs}		0.7		nC	
Gate Drain Charge	Q_{gd}		1.0		nC	
SOURCE-DRAIN DIODE						
Diode Forward Voltage ⁽¹⁾	V_{SD}			0.95	V	$T_J = 25^{\circ}\text{C}$, $I_S = 1.5\text{A}$, $V_{GS} = 0\text{V}$
Reverse Recovery Time ⁽³⁾	t_{rr}		27		ns	$T_J = 25^{\circ}\text{C}$, $I_S = 1.8\text{A}$,
Reverse Recovery Charge ⁽³⁾	Q_{rr}		12		nC	$di/dt = 100\text{A}/\mu\text{s}$

NOTES

- (1) Measured under pulsed conditions. Pulse width $\leq 300\mu\text{s}$; duty cycle $\leq 2\%$.
 (2) Switching characteristics are independent of operating junction temperature.
 (3) For design aid only, not subject to production testing.

ZXMHC10A07T8

P-Channel

ELECTRICAL CHARACTERISTICS (at $T_{amb} = 25^{\circ}\text{C}$ unless otherwise stated)

PARAMETER	SYMBOL	MIN.	TYP.	MAX.	UNIT	CONDITIONS
STATIC						
Drain-Source Breakdown Voltage	$V_{(BR)DSS}$	-100			V	$I_D = -250\mu\text{A}$, $V_{GS} = 0\text{V}$
Zero Gate Voltage Drain Current	I_{DSS}			-1.0	μA	$V_{DS} = -100\text{V}$, $V_{GS} = 0\text{V}$
Gate-Body Leakage	I_{GSS}			100	nA	$V_{GS} = \pm 20\text{V}$, $V_{DS} = 0\text{V}$
Gate-Source Threshold Voltage	$V_{GS(th)}$	-2.0		-4.0	V	$I_D = -250\mu\text{A}$, $V_{DS} = V_{GS}$
Static Drain-Source On-State Resistance ⁽¹⁾	$R_{DS(on)}$			1 1.45	Ω	$V_{GS} = -10\text{V}$, $I_D = -0.6\text{A}$ $V_{GS} = -6\text{V}$, $I_D = -0.5\text{A}$
Forward Transconductance ^{(1) (3)}	g_{fs}		1.2		S	$V_{DS} = -15\text{V}$, $I_D = -0.6\text{A}$
DYNAMIC ⁽³⁾						
Input Capacitance	C_{iss}		141		pF	$V_{DS} = -50\text{V}$, $V_{GS} = 0\text{V}$ $f = 1\text{MHz}$
Output Capacitance	C_{oss}		13.1		pF	
Reverse Transfer Capacitance	C_{rss}		10.8		pF	
SWITCHING ^{(2) (3)}						
Turn-On-Delay Time	$t_{d(on)}$		1.6		ns	$V_{DD} = -50\text{V}$, $I_D = -1\text{A}$ $R_G \cong 6.0\Omega$, $V_{GS} = -10\text{V}$
Rise Time	t_r		2.1		ns	
Turn-Off Delay Time	$t_{d(off)}$		5.9		ns	
Fall Time	t_f		3.3		ns	
Gate Charge	Q_g		1.6		nC	
Total Gate Charge	Q_g		3.5		nC	$V_{DS} = -50\text{V}$, $V_{GS} = -10\text{V}$ $I_D = -0.6\text{A}$
Gate-Source Charge	Q_{gs}		0.6		nC	
Gate Drain Charge	Q_{gd}		1.6		nC	
SOURCE-DRAIN DIODE						
Diode Forward Voltage ⁽¹⁾	V_{SD}		-0.85	-0.95	V	$T_J = 25^{\circ}\text{C}$, $I_S = -0.75\text{A}$, $V_{GS} = 0\text{V}$
Reverse Recovery Time ⁽³⁾	t_{rr}		29		ns	$T_J = 25^{\circ}\text{C}$, $I_S = -0.9\text{A}$,
Reverse Recovery Charge ⁽³⁾	Q_{rr}		31		nC	$di/dt = 100\text{A}/\mu\text{s}$

NOTES

- (1) Measured under pulsed conditions. Pulse width $\leq 300\mu\text{s}$; duty cycle $\leq 2\%$.
 (2) Switching characteristics are independent of operating junction temperature.
 (3) For design aid only, not subject to production testing.

ZXMHC10A07T8

N-CHANNEL TYPICAL CHARACTERISTICS

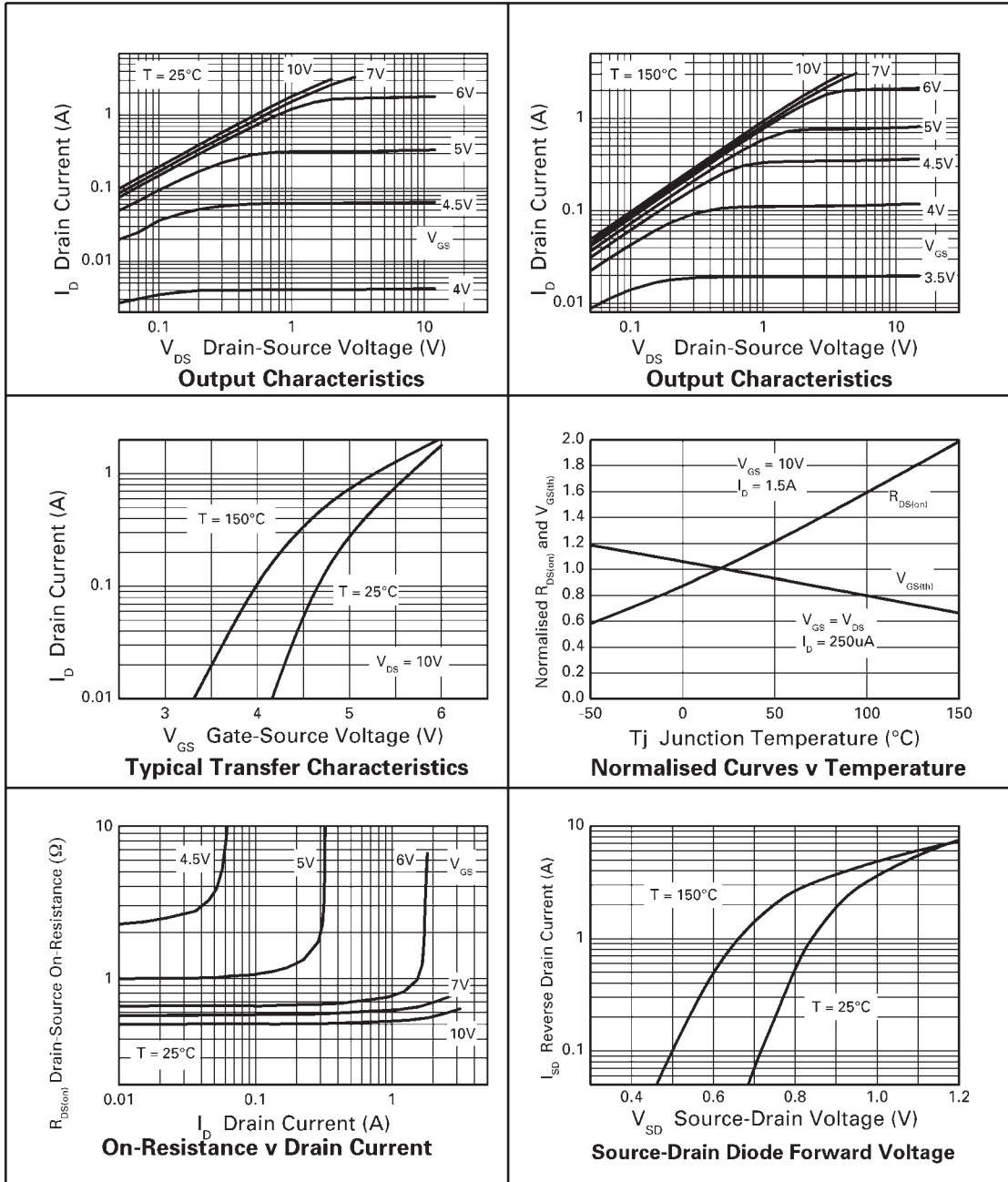

ZXMHC10A07T8

N-CHANNEL TYPICAL CHARACTERISTICS

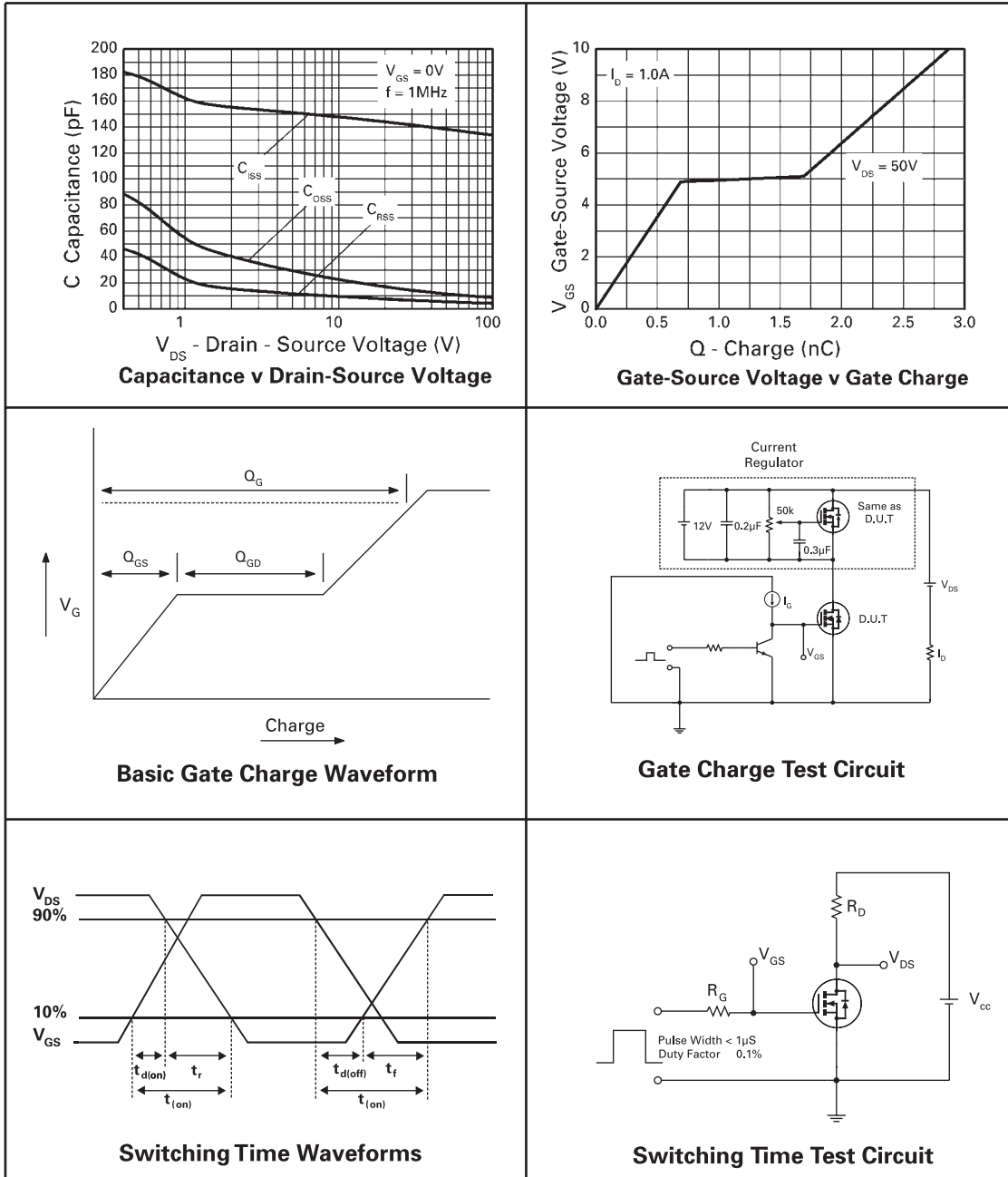

ZXMHC10A07T8

P-CHANNEL TYPICAL CHARACTERISTICS

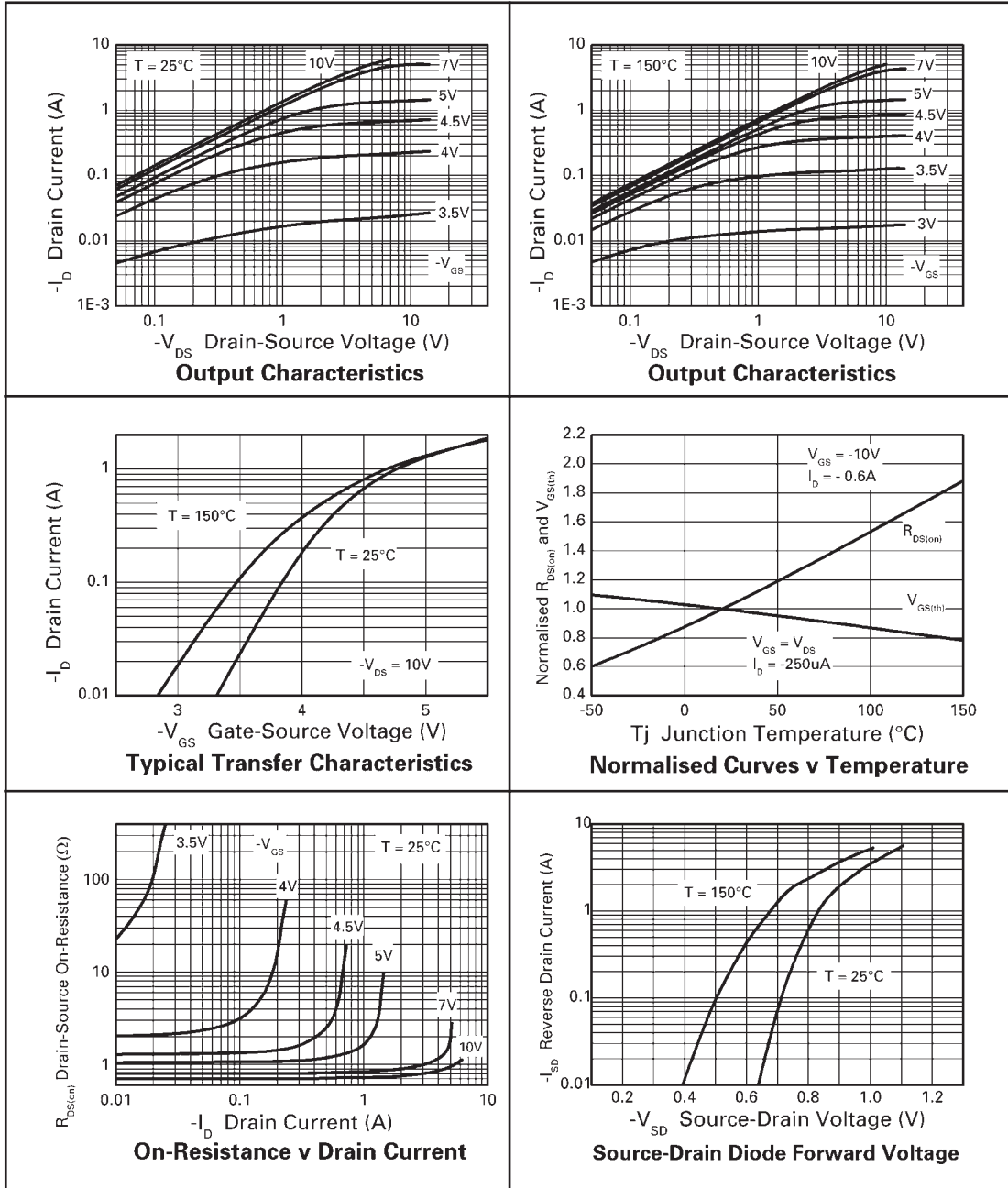

ZXMHC10A07T8

P-CHANNEL TYPICAL CHARACTERISTICS

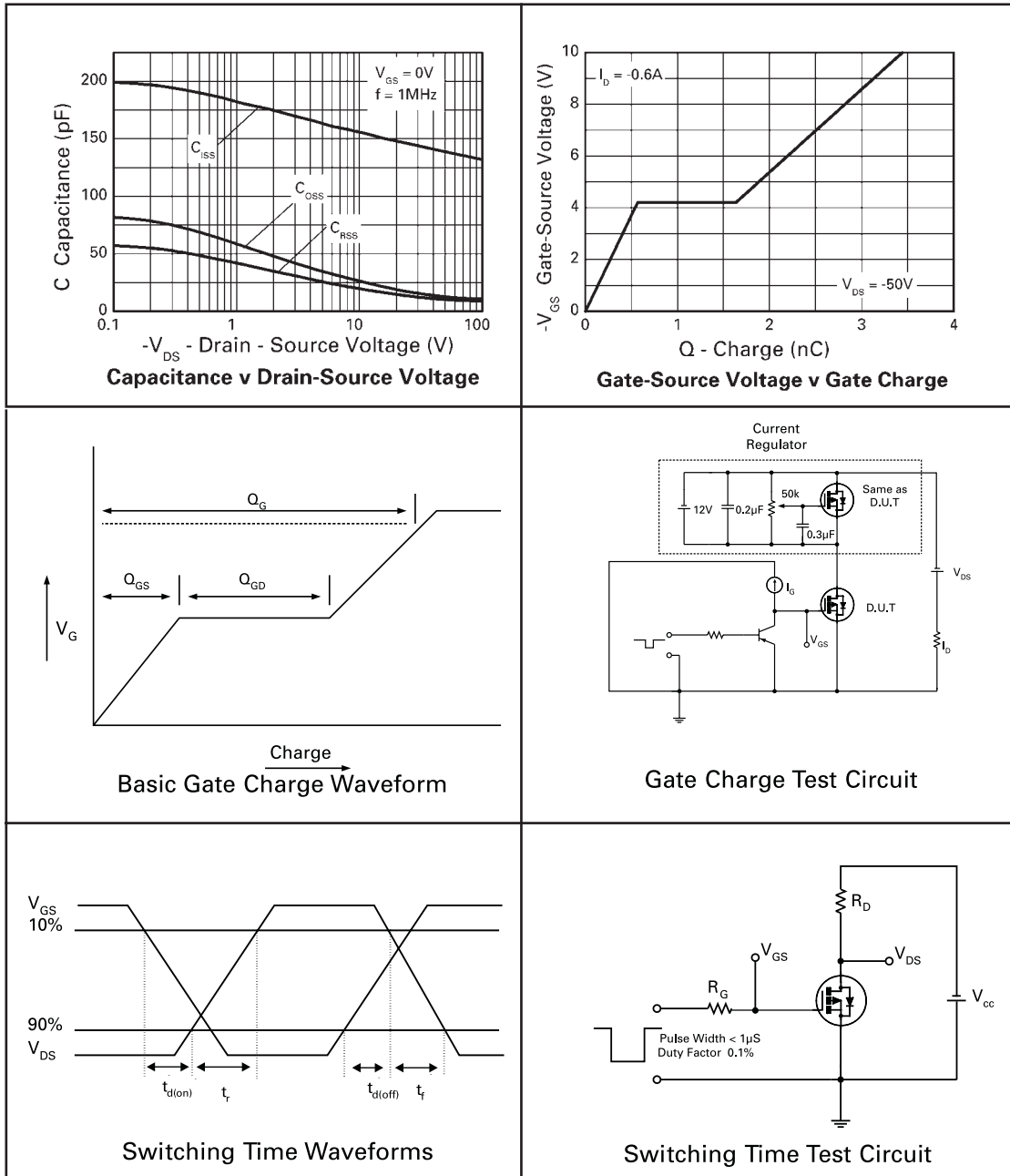

ZXMHC10A07T8

PACKAGE OUTLINE

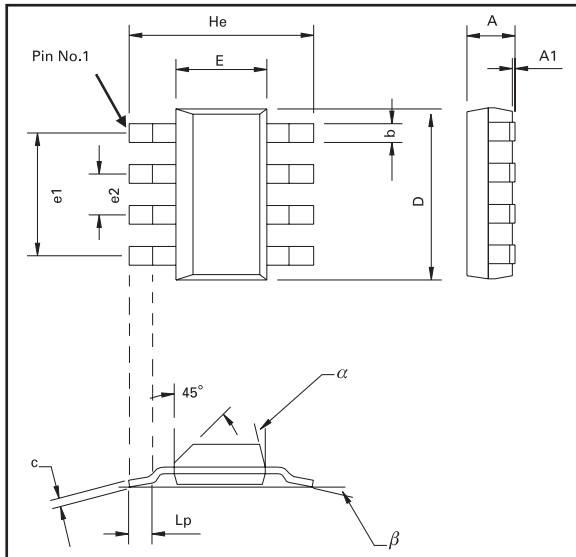

PACKAGE DIMENSIONS

DIM	Millimetres			Inches		
	MIN	TYP	MAX	MIN	TYP	MAX
A	-	-	1.7	-	-	0.067
A1	0.02	-	0.1	0.0008	-	0.004
b	-	0.7	-	-	0.028	-
c	0.24	-	0.32	0.009	-	0.013
D	6.3	-	6.7	0.248	-	0.264
E	3.3	-	3.7	0.130	-	0.145
e1	-	4.59	-	-	0.180	-
e2	-	1.53	-	-	0.060	-
He	6.7	-	7.3	0.264	-	0.287
Lp	0.9	-	-	0.035	-	-
α	-	-	15°	-	-	15°
β	-	10°	-	-	10°	-

Controlling dimensions are in millimetres. Approximate conversions are given in inches

© Zetex Semiconductors plc 2005

Europe	Americas	Asia Pacific	Corporate Headquarters
Zetex GmbH Streitfeldstraße 19 D-81673 München Germany	Zetex Inc 700 Veterans Memorial Hwy Hauppauge, NY 11788 USA	Zetex (Asia) Ltd 3701-04 Metroplaza Tower 1 Hing Fong Road, Kwai Fong Hong Kong	Zetex Semiconductors plc Zetex Technology Park Chadderton, Oldham, OL9 9LL United Kingdom
Telefon: (49) 89 45 49 49 0 Fax: (49) 89 45 49 49 49 europa.sales@zetex.com	Telephone: (1) 631 360 2222 Fax: (1) 631 360 8222 usa.sales@zetex.com	Telephone: (852) 26100 611 Fax: (852) 24250 494 asia.sales@zetex.com	Telephone (44) 161 622 4444 Fax: (44) 161 622 4446 hq@zetex.com

These offices are supported by agents and distributors in major countries world-wide.

This publication is issued to provide outline information only which (unless agreed by the Company in writing) may not be used, applied or reproduced for any purpose or form part of any order or contract or be regarded as a representation relating to the products or services concerned. The Company reserves the right to alter without notice the specification, design, price or conditions of supply of any product or service.

For the latest product information, log on to www.zetex.com



ISSUE 2 - JUNE 2005