

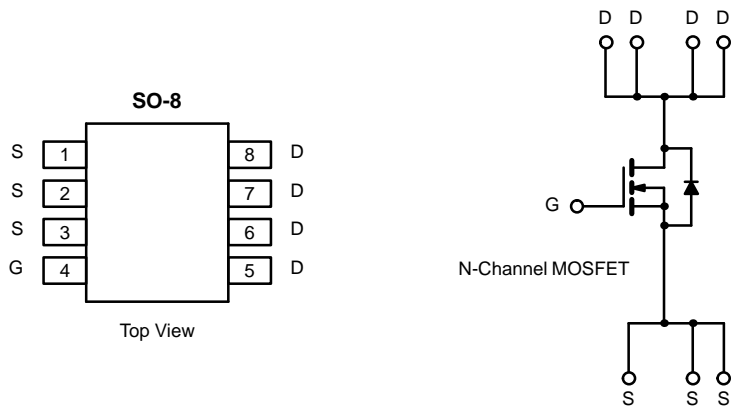

## N-Channel Reduced $Q_g$ , Fast Switching MOSFET

**TrenchFET<sup>®</sup>**  
Power MOSFETs  
**High-Efficiency**  
PWM Optimized

PRODUCT SUMMARY		
$V_{DS}$ (V)	$r_{DS(on)}$ ( $\Omega$ )	$I_D$ (A)
30	0.0105 @ $V_{GS} = 10$ V	$\pm 11$
	0.0205 @ $V_{GS} = 4.5$ V	$\pm 8$



ABSOLUTE MAXIMUM RATINGS ( $T_A = 25^\circ\text{C}$ UNLESS OTHERWISE NOTED)			
Parameter	Symbol	Limit	Unit
Drain-Source Voltage	$V_{DS}$	30	V
Gate-Source Voltage	$V_{GS}$	$\pm 25$	
Continuous Drain Current ( $T_J = 150^\circ\text{C}$ ) <sup>a, b</sup>	$I_D$	$T_A = 25^\circ\text{C}$	$\pm 11$
		$T_A = 70^\circ\text{C}$	$\pm 9$
Pulsed Drain Current	$I_{DM}$	$\pm 50$	A
Continuous Source Current (Diode Conduction) <sup>a, b</sup>	$I_S$	2.3	
Maximum Power Dissipation <sup>a, b</sup>	$P_D$	$T_A = 25^\circ\text{C}$	2.5
		$T_A = 70^\circ\text{C}$	1.6
Operating Junction and Storage Temperature Range	$T_J, T_{stg}$	-55 to 150	$^\circ\text{C}$

THERMAL RESISTANCE RATINGS					
Parameter		Symbol	Typical	Maximum	Unit
Maximum Junction-to-Ambient (MOSFET) <sup>a</sup>	$t \leq 10$ sec	$R_{thJA}$	35	50	$^\circ\text{C/W}$
	Steady State		68	80	
Maximum Junction-to-Foot			$R_{thJF}$	19	

Notes

- a. Surface Mounted on FR4 Board.
- b.  $t \leq 10$  sec.



MOSFET SPECIFICATIONS (T <sub>J</sub> = 25 °C UNLESS OTHERWISE NOTED)						
Parameter	Symbol	Test Condition	Min	Typ	Max	Unit
<b>Static</b>						
Gate Threshold Voltage	V <sub>GS(th)</sub>	V <sub>DS</sub> = V <sub>GS</sub> , I <sub>D</sub> = 250 μA	1.0			V
Gate-Body Leakage	I <sub>GSS</sub>	V <sub>DS</sub> = 0 V, V <sub>GS</sub> = ± 20 V			± 100	nA
Zero Gate Voltage Drain Current	I <sub>DSS</sub>	V <sub>DS</sub> = 24 V, V <sub>GS</sub> = 0 V			1	μA
		V <sub>DS</sub> = 24 V, V <sub>GS</sub> = 0 V, T <sub>J</sub> = 55 °C			5	
On-State Drain Current <sup>a</sup>	I <sub>D(on)</sub>	V <sub>DS</sub> ≥ 5 V, V <sub>GS</sub> = 10 V	40			A
Drain-Source On-State Resistance <sup>a</sup>	r <sub>DS(on)</sub>	V <sub>GS</sub> = 10 V, I <sub>D</sub> = 11 A		0.0087	0.0105	Ω
		V <sub>GS</sub> = 4.5 V, I <sub>D</sub> = 8 A		0.017	0.0205	
Forward Transconductance <sup>a</sup>	g <sub>fs</sub>	V <sub>DS</sub> = 15 V, I <sub>D</sub> = 11 A		26		S
Diode Forward Voltage <sup>a</sup>	V <sub>SD</sub>	I <sub>S</sub> = 2.3 A, V <sub>GS</sub> = 0 V		0.70	1.1	V
<b>Dynamic<sup>b</sup></b>						
Total Gate Charge	Q <sub>g</sub>	V <sub>DS</sub> = 15 V, V <sub>GS</sub> = 5.0 V, I <sub>D</sub> = 11 A		13.5	17	nC
Gate-Source Charge	Q <sub>gs</sub>			3.9		
Gate-Drain Charge	Q <sub>gd</sub>			6.0		
Turn-On Delay Time	t <sub>d(on)</sub>	V <sub>DD</sub> = 15 V, R <sub>L</sub> = 15 Ω I <sub>D</sub> ≅ 1 A, V <sub>GEN</sub> = 10 V, R <sub>G</sub> = 6 Ω		13	20	ns
Rise Time	t <sub>r</sub>			8	12	
Turn-Off Delay Time	t <sub>d(off)</sub>			45	68	
Fall Time	t <sub>f</sub>			19	30	
Source-Drain Reverse Recovery Time	t <sub>rr</sub>	I <sub>F</sub> = 2.3 A, di/dt = 100 A/μs		40	70	

Notes

- a. Pulse test; pulse width ≤ 300 μs, duty cycle ≤ 2%.
- b. Guaranteed by design, not subject to production testing.

**TYPICAL CHARACTERISTICS (25 °C UNLESS NOTED)**

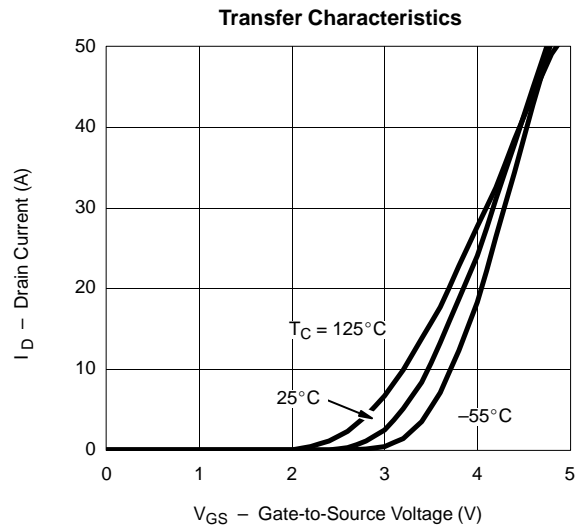
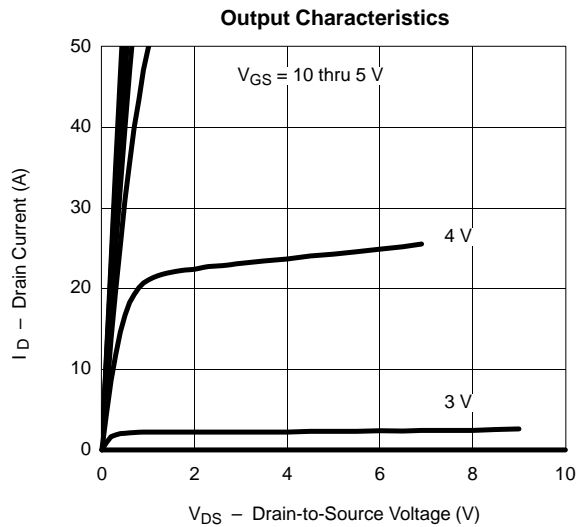



**TYPICAL CHARACTERISTICS (25°C UNLESS NOTED)**

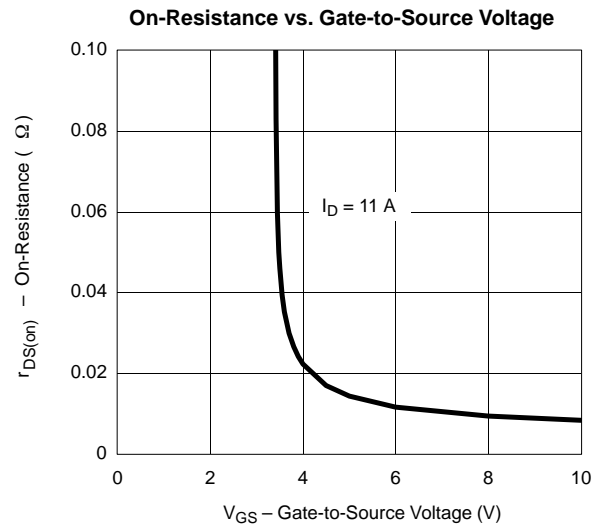
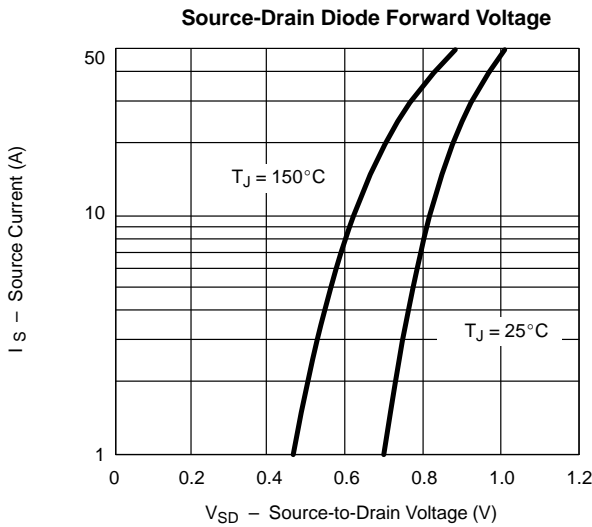
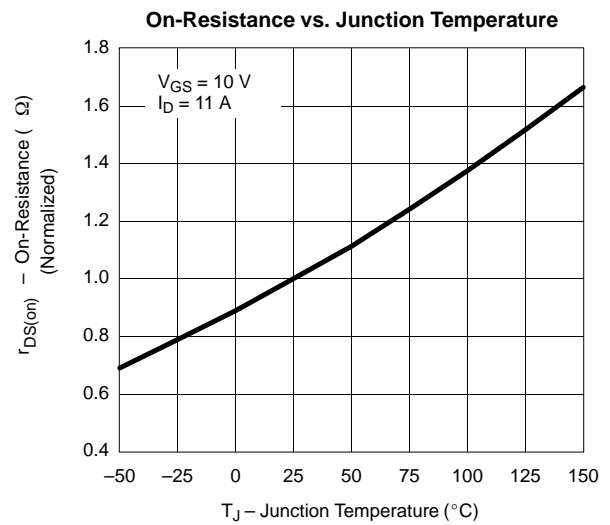
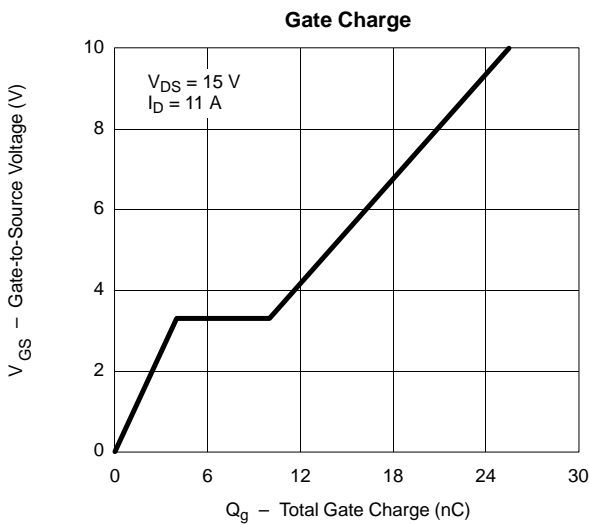
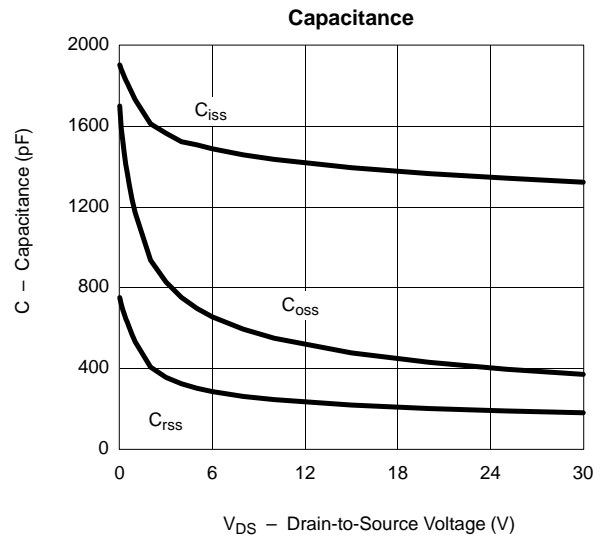
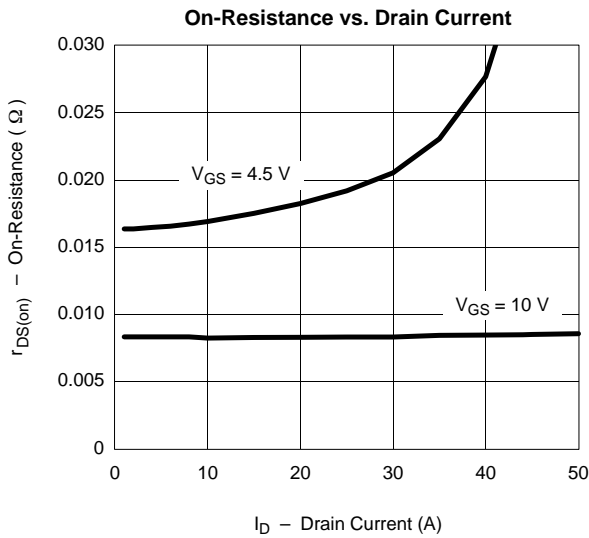



**TYPICAL CHARACTERISTICS (25°C UNLESS NOTED)**

