

# ZXM62P03E6

## 30V P-CHANNEL ENHANCEMENT MODE MOSFET

### SUMMARY

$V_{(BR)DSS} = -30V$ ;  $R_{DS(ON)} = 0.15\Omega$ ;  $I_D = -2.6A$

### DESCRIPTION

This new generation of high density MOSFETs from Zetex utilizes a unique structure that combines the benefits of low on-resistance with fast switching speed. This makes them ideal for high efficiency, low voltage, power management applications.

### FEATURES

- Low on-resistance
- Fast switching speed
- Low threshold
- Low gate drive
- SOT23-6 package

### APPLICATIONS

- DC - DC converters
- Power management functions
- Disconnect switches
- Motor control

### ORDERING INFORMATION

DEVICE	REEL SIZE (inches)	TAPE WIDTH (mm)	QUANTITY PER REEL
ZXM62P03E6TA	7	8 embossed	3,000
ZXM62P03E6TC	13	8 embossed	10,000

### DEVICE MARKING

2P03

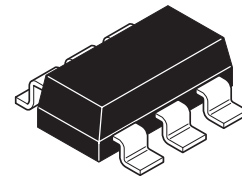

SOT23-6

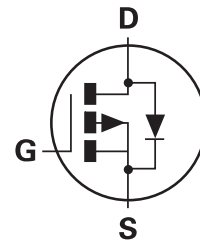

Pinout

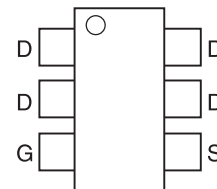

Top view

# ZXM62P03E6

## ABSOLUTE MAXIMUM RATINGS

PARAMETER	SYMBOL	LIMIT	UNIT
Drain-Source Voltage	$V_{DSS}$	20	V
Gate Source Voltage	$V_{GS}$	$\pm 12$	V
Continuous Drain Current ( $V_{GS}=4.5V$ ; $T_A=25^\circ C$ )(a) ( $V_{GS}=4.5V$ ; $T_A=70^\circ C$ )(a)	$I_D$	1.5 1.2	A
Pulsed Drain Current (c)	$I_{DM}$	7.4	A
Continuous Source Current (Body Diode)	$I_S$	0.54	A
Pulsed Source Current (Body Diode)	$I_{SM}$	7.4	A
Power Dissipation at $T_A=25^\circ C$ (a) Linear Derating Factor	$P_D$	625 5	mW mW/ $^\circ C$
Power Dissipation at $T_A=25^\circ C$ (b) Linear Derating Factor	$P_D$	806 6.4	mW mW/ $^\circ C$
Operating and Storage Temperature Range	$T_j; T_{stg}$	-55 to +150	$^\circ C$

## THERMAL RESISTANCE

PARAMETER	SYMBOL	VALUE	UNIT
Junction to Ambient (a)	$R_{\theta JA}$	113	$^\circ C/W$
Junction to Ambient (b)	$R_{\theta JA}$	73	$^\circ C/W$

### NOTES:

- (a) For a device surface mounted on 25mm x 25mm FR4 PCB with high coverage of single sided 1oz copper, in still air conditions  
(b) For a device surface mounted on FR4 PCB measured at  $t \leq 5$  secs.  
(c) Repetitive rating - pulse width limited by maximum junction temperature. Refer to Transient Thermal Impedance graph.

# ZXM62P03E6

## CHARACTERISTICS

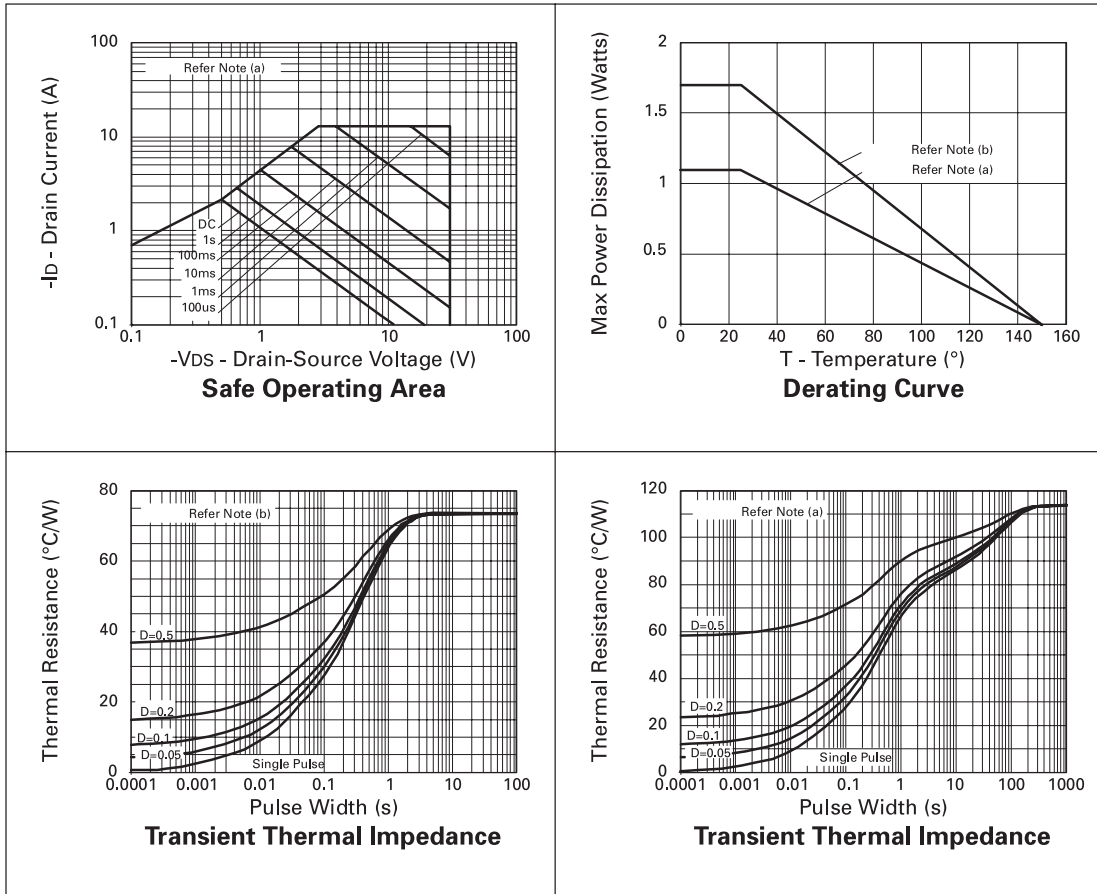

# ZXM62P03E6

## ELECTRICAL CHARACTERISTICS (at $T_{amb} = 25^{\circ}\text{C}$ unless otherwise stated)

PARAMETER	SYMBOL	MIN.	TYP.	MAX.	UNIT	CONDITIONS
<b>STATIC</b>						
Drain-Source Breakdown Voltage	$V_{(BR)DSS}$	-30			V	$I_D = -250\mu\text{A}$ , $V_{GS} = 0\text{V}$
Zero Gate Voltage Drain Current	$I_{DSS}$			-1	$\mu\text{A}$	$V_{DS} = -30\text{V}$ , $V_{GS} = 0\text{V}$
Gate-Body Leakage	$I_{GSS}$			$\pm 100$	nA	$V_{GS} = \pm 20\text{V}$ , $V_{DS} = 0\text{V}$
Gate-Source Threshold Voltage	$V_{GS(th)}$	-1.0			V	$I_D = -250\mu\text{A}$ , $V_{DS} = V_{GS}$
Static Drain-Source On-State Resistance (1)	$R_{DS(on)}$			0.15 0.23	$\Omega$	$V_{GS} = -10\text{V}$ , $I_D = -1.6\text{A}$ $V_{GS} = -4.5\text{V}$ , $I_D = -0.8\text{A}$
Forward Transconductance (3)	$g_{fs}$	1.1			S	$V_{DS} = -10\text{V}$ , $I_D = -0.8\text{A}$
<b>DYNAMIC (3)</b>						
Input Capacitance	$C_{iss}$		330		pF	$V_{DS} = -25\text{V}$ , $V_{GS} = 0\text{V}$ , $f = 1\text{MHz}$
Output Capacitance	$C_{oss}$		120		pF	
Reverse Transfer Capacitance	$C_{rss}$		45		pF	
<b>SWITCHING (2) (3)</b>						
Turn-On Delay Time	$t_{d(on)}$		2.8		ns	$V_{DD} = -15\text{V}$ , $I_D = -1.6\text{A}$ $R_G = 6.2\Omega$ , $R_D = 25\Omega$ (Refer to test circuit)
Rise Time	$t_r$		6.4		ns	
Turn-Off Delay Time	$t_{d(off)}$		13.9		ns	
Fall Time	$t_f$		10.3		ns	
Total Gate Charge	$Q_g$			10.2	nC	$V_{DS} = -24\text{V}$ , $V_{GS} = -10\text{V}$ , $I_D = -1.6\text{A}$ (Refer to test circuit)
Gate-Source Charge	$Q_{gs}$			1.5	nC	
Gate Drain Charge	$Q_{gd}$			3	nC	
<b>SOURCE-DRAIN DIODE</b>						
Diode Forward Voltage (1)	$V_{SD}$			-0.95	V	$T_j = 25^{\circ}\text{C}$ , $I_S = -1.6\text{A}$ , $V_{GS} = 0\text{V}$
Reverse Recovery Time (3)	$t_{rr}$		19.9		ns	$T_j = 25^{\circ}\text{C}$ , $I_F = -1.6\text{A}$ , $di/dt = 100\text{A}/\mu\text{s}$
Reverse Recovery Charge(3)	$Q_{rr}$		13		nC	

(1) Measured under pulsed conditions. Width=300 $\mu\text{s}$ . Duty cycle  $\leq 2\%$ .

(2) Switching characteristics are independent of operating junction temperature.

(3) For design aid only, not subject to production testing.

# ZXM62P03E6

## TYPICAL CHARACTERISTICS

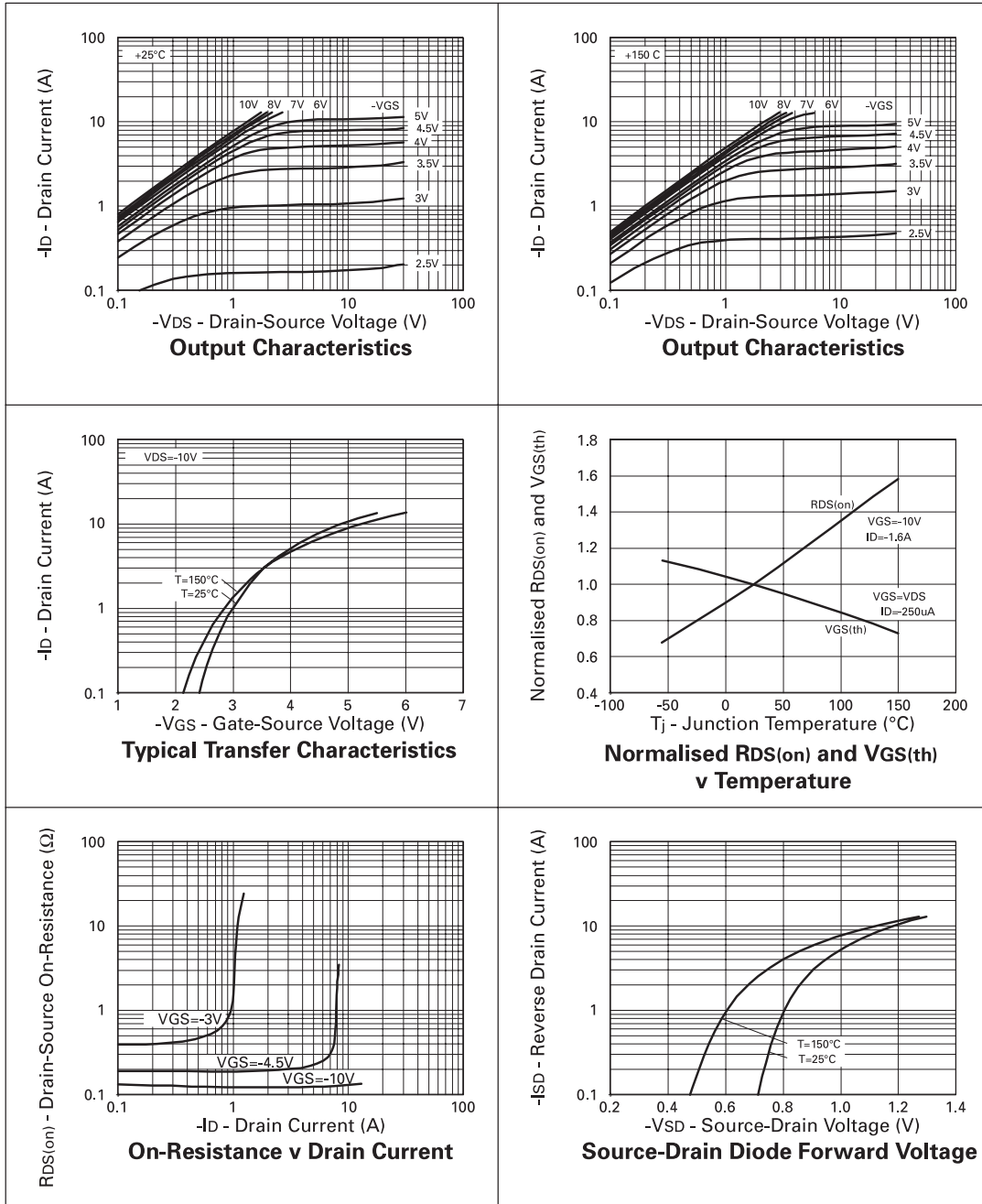

# ZXM62P03E6

## TYPICAL CHARACTERISTICS

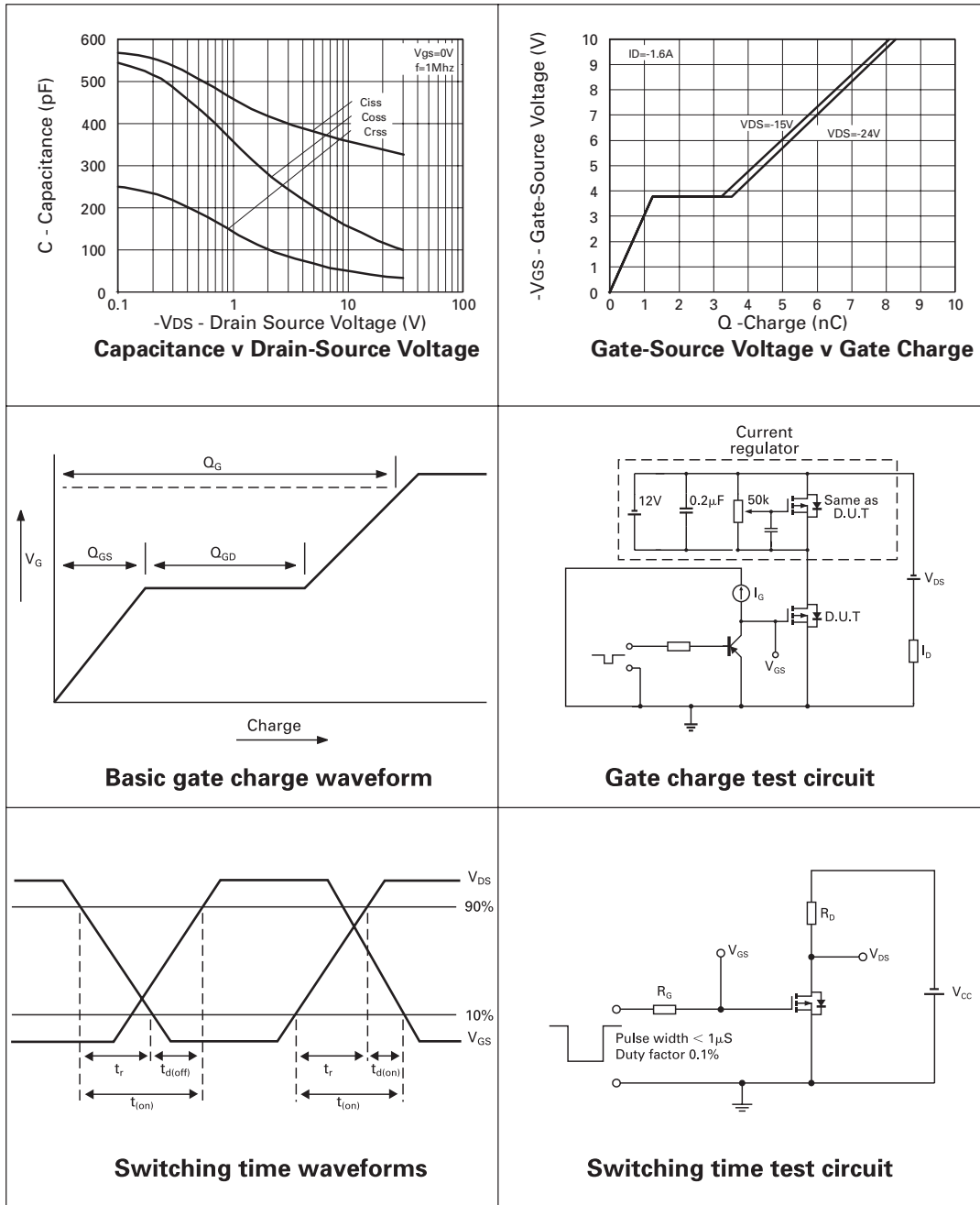

# ZXM62P03E6

## PACKAGE OUTLINE

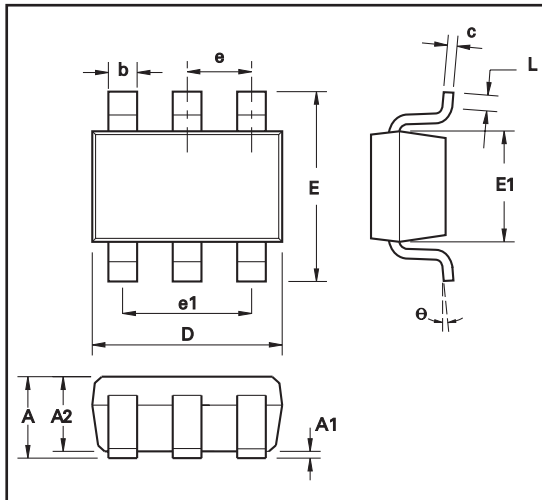

## PAD LAYOUT DETAILS

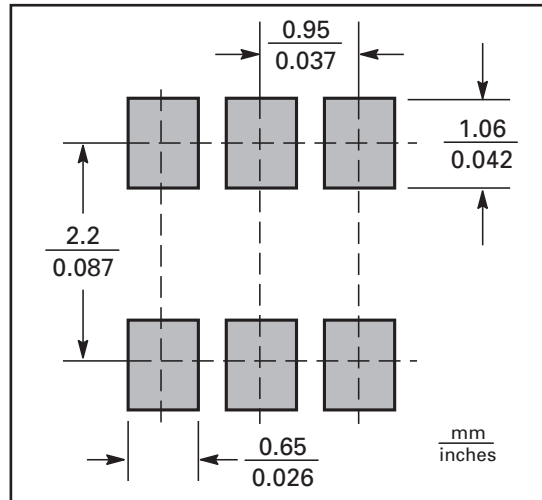

DIM	Millimeters		Inches	
	Min.	Max.	Min.	Max.
A	0.90	1.45	0.35	0.057
A1	0.00	0.15	0	0.006
A2	0.90	1.30	0.035	0.051
b	0.35	0.50	0.014	0.019
C	0.09	0.20	0.0035	0.008
D	2.80	3.00	0.110	0.118
E	2.60	3.00	0.102	0.118
E1	1.50	1.75	0.059	0.069
L	0.10	0.60	0.004	0.002
e	0.95 REF		0.037 REF	
e1	1.90 REF		0.074 REF	
L	0°	10°	0°	10°

© Zetex Semiconductors plc 2005

Europe	Americas	Asia Pacific	Corporate Headquarters
Zetex GmbH Streitfeldstraße 19 D-81673 München Germany	Zetex Inc 700 Veterans Memorial Hwy Hauppauge, NY 11788 USA	Zetex (Asia) Ltd 3701-04 Metroplaza Tower 1 Hing Fong Road, Kwai Fong Hong Kong	Zetex Semiconductors plc Zetex Technology Park Chadderton, Oldham, OL9 9LL United Kingdom
Telephone: (49) 89 45 49 49 0 Fax: (49) 89 45 49 49 49 <a href="mailto:europa.sales@zetex.com">europa.sales@zetex.com</a>	Telephone: (1) 631 360 2222 Fax: (1) 631 360 8222 <a href="mailto:usa.sales@zetex.com">usa.sales@zetex.com</a>	Telephone: (852) 26100 611 Fax: (852) 24250 494 <a href="mailto:asia.sales@zetex.com">asia.sales@zetex.com</a>	Telephone (44) 161 622 4444 Fax: (44) 161 622 4446 <a href="mailto:hq@zetex.com">hq@zetex.com</a>

These offices are supported by agents and distributors in major countries world-wide.

This publication is issued to provide outline information only which (unless agreed by the Company in writing) may not be used, applied or reproduced for any purpose or form part of any order or contract or be regarded as a representation relating to the products or services concerned. The Company reserves the right to alter without notice the specification, design, price or conditions of supply of any product or service.

For the latest product information, log on to [www.zetex.com](http://www.zetex.com)

ISSUE 1 - OCTOBER 2005