

ZXMN2B03E6

20V SOT23-6 N-channel enhancement mode MOSFET with low gate drive capability

Summary

$V_{(BR)DSS}$	$R_{DS(on)}$ (Ω)	I_D (A)
20	0.040 @ $V_{GS}= 4.5V$	5.4
	0.055 @ $V_{GS}= 2.5V$	4.6
	0.075 @ $V_{GS}= 1.8V$	4.0

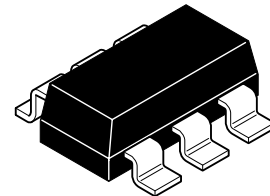

Description

This new generation trench MOSFET from Zetex features low on-resistance achievable with low gate drive.

Features

- Low on-resistance
- Fast switching speed
- Low gate drive capability
- SOT23-6 package

Applications

- DC-DC converters
- Power management functions
- Disconnect switches
- Motor control

Ordering information

Device	Reel size (inches)	Tape width (mm)	Quantity per reel
ZXMN2B03E6TA	7	8	3,000

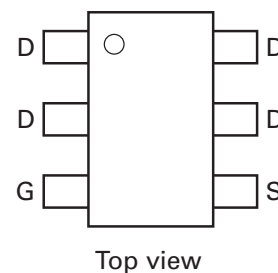
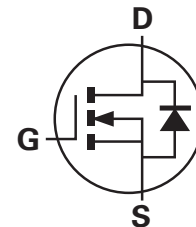

Device marking

2B3

ZXMN2B03E6

Absolute maximum ratings

Parameter	Symbol	Limit	Unit
Drain-source voltage	V_{DSS}	20	V
Gate-source voltage	V_{GS}	± 8	V
Continuous drain current @ $V_{GS} = 4.5V$; $T_{amb} = 25^{\circ}C^{(b)}$	I_D	5.4	A
@ $V_{GS} = 4.5V$; $T_{amb} = 70^{\circ}C^{(b)}$		4.3	
@ $V_{GS} = 4.5V$; $T_{amb} = 25^{\circ}C^{(a)}$		4.3	
Pulsed drain current ^(c)	I_{DM}	26	A
Continuous source current (body diode) ^(b)	I_S	2.8	A
Pulsed source current (body diode) ^(c)	I_{SM}	26	A
Power dissipation at $T_{amb} = 25^{\circ}C^{(a)}$	P_D	1.1	W
Linear derating factor		8.8	mW/ $^{\circ}C$
Power dissipation at $T_{amb} = 25^{\circ}C^{(b)}$	P_D	1.7	W
Linear derating factor		13.7	mW/ $^{\circ}C$
Operating and storage temperature range	T_j, T_{stg}	-55 to +150	$^{\circ}C$

Thermal resistance

Parameter	Symbol	Limit	Unit
Junction to ambient ^(a)	$R_{\theta JA}$	113	$^{\circ}C/W$
Junction to ambient ^(b)	$R_{\theta JA}$	73	$^{\circ}C/W$

NOTES:

(a) For a device surface mounted on 25mm x 25mm FR4 PCB with high coverage of single sided 1oz copper, in still air conditions.

(b) For a device surface mounted on FR4 PCB measured at $t \leq 5$ sec.

(c) Repetitive rating - 25mm x 25mm FR4 PCB, $D=0.02$, pulse width 300 μ s - pulse width limited by maximum junction temperature.

ZXMN2B03E6

Thermal characteristics

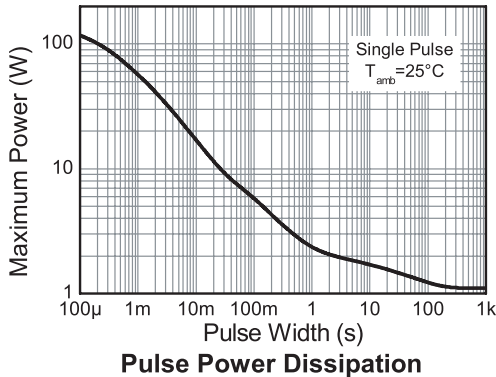
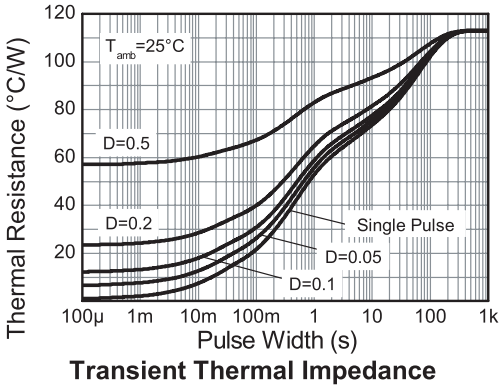
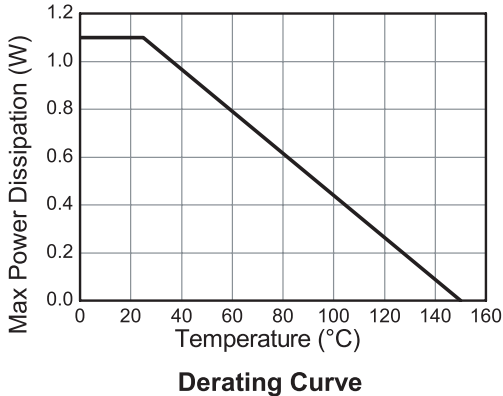
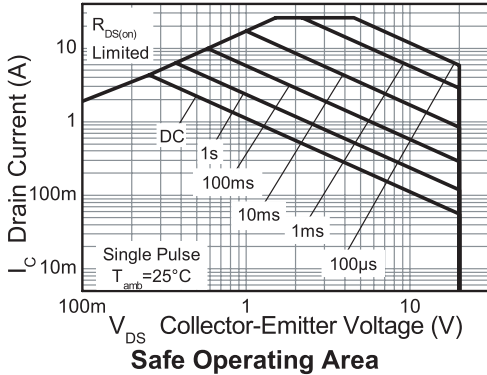

ZXMN2B03E6

Electrical characteristics (at $T_{amb} = 25^{\circ}\text{C}$ unless otherwise stated)

Parameter	Symbol	Min.	Typ.	Max.	Unit	Conditions
Static						
Drain-source breakdown voltage	$V_{(BR)DSS}$	20			V	$I_D = 250\mu\text{A}$, $V_{GS} = 0\text{V}$
Zero gate voltage drain current	I_{DSS}			1	μA	$V_{DS} = 20\text{V}$, $V_{GS} = 0\text{V}$
Gate-body leakage	I_{GSS}			100	nA	$V_{GS} = \pm 8\text{V}$, $V_{DS} = 0\text{V}$
Gate-source threshold voltage	$V_{GS(th)}$	0.4		1.0	V	$I_D = 250\mu\text{A}$, $V_{DS} = V_{GS}$
Static drain-source on-state resistance (*)	$R_{DS(on)}$			0.040	Ω	$V_{GS} = 4.5\text{V}$, $I_D = 4.3\text{A}$
				0.055	Ω	$V_{GS} = 2.5\text{V}$, $I_D = 3.7\text{A}$
				0.075	Ω	$V_{GS} = 1.8\text{V}$, $I_D = 3.2\text{A}$
Forward transconductance(*) (‡)	g_{fs}		13.5		S	$V_{DS} = 10\text{V}$, $I_D = 4.3\text{A}$
Dynamic(‡)						
Input capacitance	C_{iss}		1160		pF	$V_{DS} = 10\text{V}$, $V_{GS} = 0\text{V}$ $f = 1\text{MHz}$
Output capacitance	C_{oss}		210		pF	
Reverse transfer capacitance	C_{rss}		136		pF	
Switching (†) (‡)						
Turn-on-delay time	$t_{d(on)}$		4.2		ns	$V_{DD} = 10\text{V}$, $V_{GS} = 4.5\text{V}$ $I_D = 1\text{A}$ $R_G \approx 6.0\Omega$
Rise time	t_r		6.2		ns	
Turn-off delay time	$t_{d(off)}$		33.9		ns	
Fall time	t_f		12.4		ns	
Total gate charge	Q_g		14.5		nC	$V_{DS} = 10\text{V}$, $V_{GS} = 4.5\text{V}$ $I_D = 4.3\text{A}$
Gate-source charge	Q_{gs}		2		nC	
Gate drain charge	Q_{gd}		2.8		nC	
Source-drain diode						
Diode forward voltage(*)	V_{SD}		0.67	0.95	V	$T_J = 25^{\circ}\text{C}$, $I_S = 1.8\text{A}$, $V_{GS} = 0\text{V}$
Reverse recovery time(‡)	t_{rr}		10.8		ns	$T_J = 25^{\circ}\text{C}$, $I_F = 2.8\text{A}$, $di/dt = 100\text{A}/\mu\text{s}$
Reverse recovery charge(‡)	Q_{rr}		3.4		nC	

NOTES:

(*) Measured under pulsed conditions. Pulse width $\leq 300\mu\text{s}$; duty cycle $\leq 2\%$.

(†) Switching characteristics are independent of operating junction temperature.

(‡) For design aid only, not subject to production testing.

ZXMN2B03E6

Typical characteristics

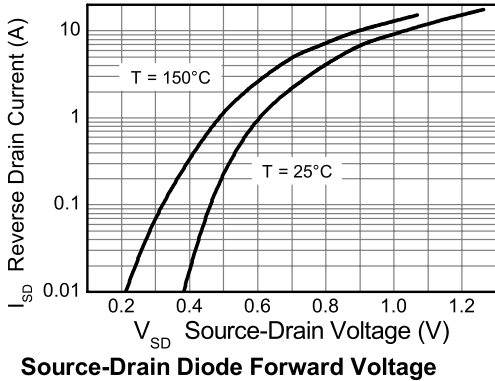
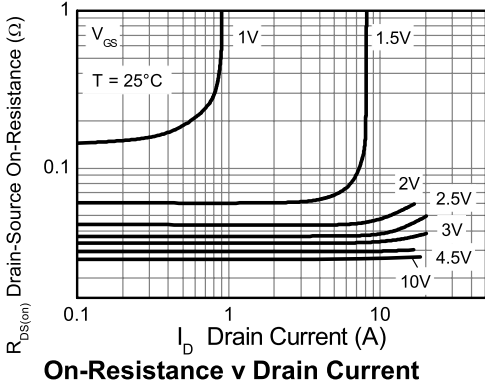
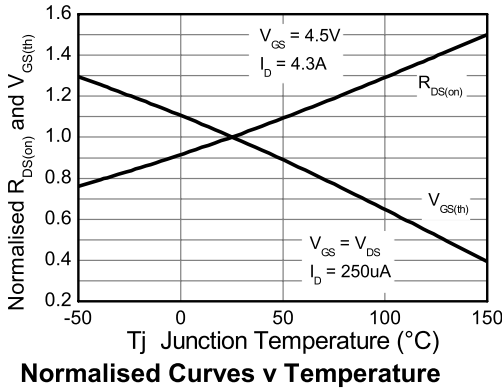
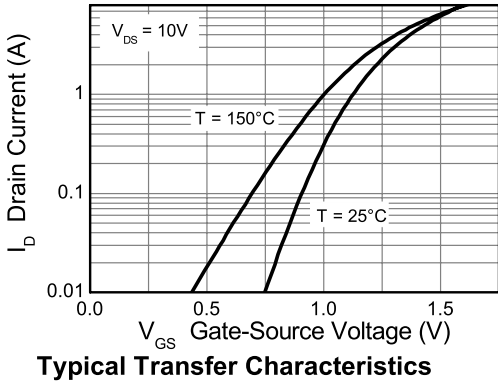
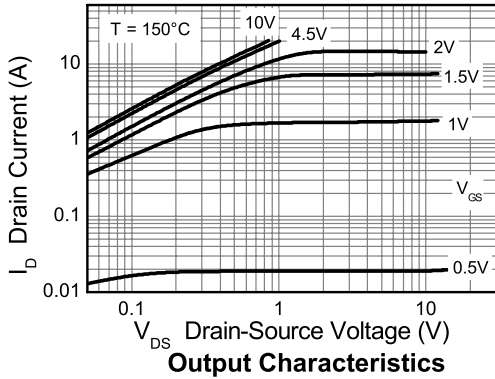
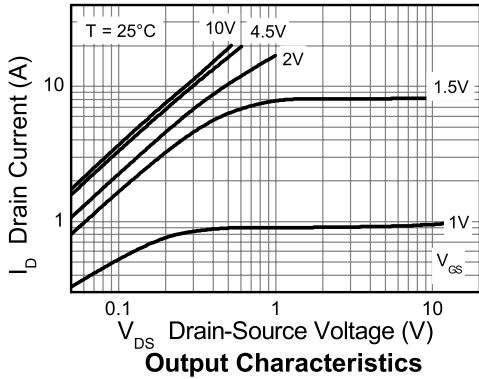

Downloaded from Elcodis.com electronic components distributor

ZXMN2B03E6

Typical characteristics

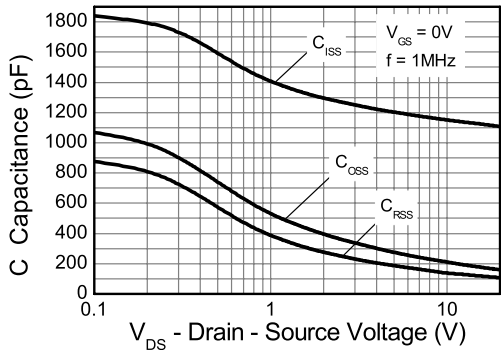

Capacitance v Drain-Source Voltage

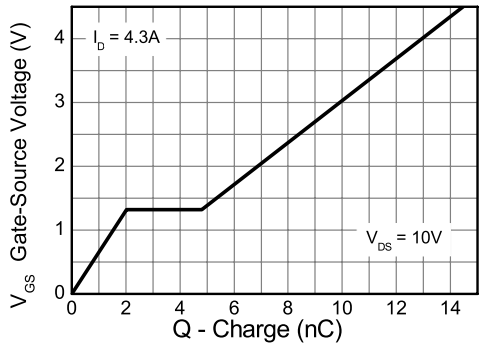

Gate-Source Voltage v Gate Charge

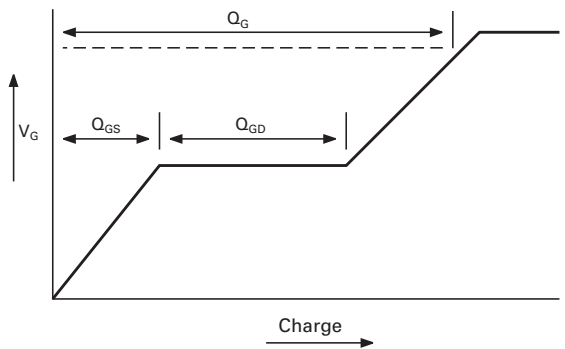

Basic gate charge waveform

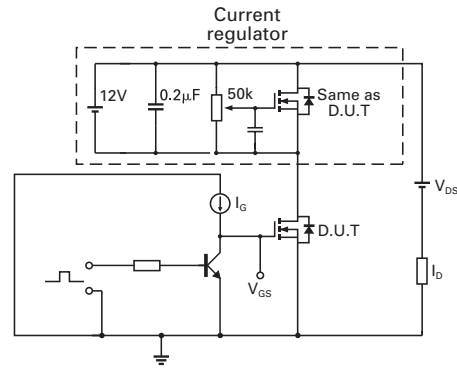

Gate charge test circuit

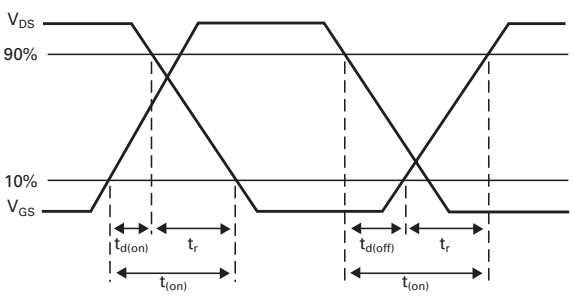

Switching time waveforms

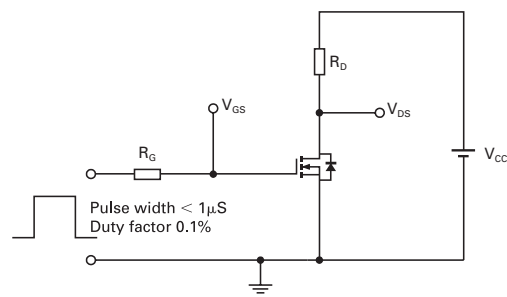

Switching time test circuit

Downloaded from Elcodis.com electronic components distributor

ZXMN2B03E6

Intentionally left blank

ZXMN2B03E6

Package outline - SOT23-6

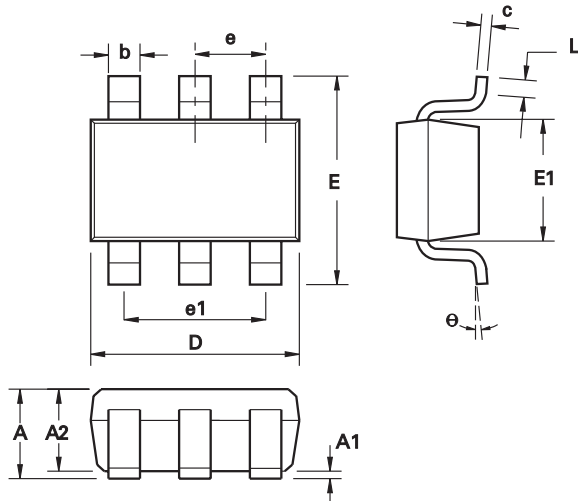

DIM	Millimeters		Inches	
	Min.	Max.	Min.	Max.
A	0.90	1.45	0.354	0.0570
A1	0.00	0.15	0.00	0.0059
A2	0.90	1.30	0.0354	0.0511
b	0.35	0.50	0.0078	0.0196
C	0.09	0.26	0.0035	0.0102
D	2.70	3.10	0.1062	0.1220
E	2.20	3.20	0.0866	0.1181
E1	1.30	1.80	0.0511	0.0708
L	0.10	0.60	0.0039	0.0236
e	0.95 REF		0.0374 REF	
e1	1.90 REF		0.0748 REF	
L	0°	30°	0°	30°

Note: Controlling dimensions are in millimeters. Approximate dimensions are provided in inches

Europe	Americas	Asia Pacific	Corporate Headquarters
Zetex GmbH Kustermann-park Balanstraße 59 D-81541 München Germany Telefon: (49) 89 45 49 49 0 Fax: (49) 89 45 49 49 49 europe.sales@zetex.com	Zetex Inc 700 Veterans Memorial Highway Hauppauge, NY 11788 USA Telephone: (1) 631 360 2222 Fax: (1) 631 360 8222 usa.sales@zetex.com	Zetex (Asia Ltd) 3701-04 Metroplaza Tower 1 Hing Fong Road, Kwai Fong Hong Kong Telephone: (852) 26100 611 Fax: (852) 24250 494 asia.sales@zetex.com	Zetex Semiconductors plc Zetex Technology Park, Chadderton Oldham, OL9 9LL United Kingdom Telephone: (44) 161 622 4444 Fax: (44) 161 622 4446 hq@zetex.com

For international sales offices visit www.zetex.com/offices

Zetex products are distributed worldwide. For details, see www.zetex.com/salesnetwork

This publication is issued to provide outline information only which (unless agreed by the company in writing) may not be used, applied or reproduced for any purpose or form part of any order or contract or be regarded as a representation relating to the products or services concerned. The company reserves the right to alter without notice the specification, design, price or conditions of supply of any product or service.