

N-Channel 20-V (D-S) Fast Switching MOSFET

PRODUCT SUMMARY			
V _{DS} (V)	R _{DS(on)} (Ω)	I _D (A)	Q _g (Typ.)
20	0.0053 at V _{GS} = 10 V	21.1	14 nC
	0.0078 at V _{GS} = 4.5 V	17.4	

FEATURES

- Halogen-free Option Available
- TrenchFET[®] Gen II Power MOSFET
- New Low Thermal Resistance PowerPAK[®] Package with Low 1.07 mm Profile
- PWM Optimized
- 100 % R_g Tested



APPLICATIONS

- Synchronous Rectification
- Synchronous Buck

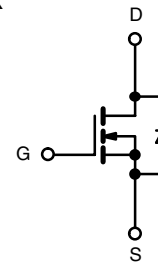
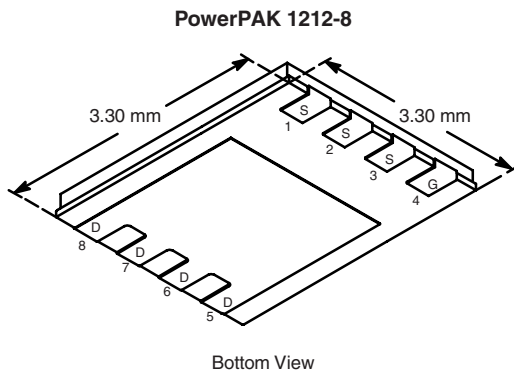

N-Channel MOSFET

Ordering Information: Si7110DN-T1-E3 (Lead (Pb)-free)
Si7110DN-T1-GE3 (Lead (Pb)-free and Halogen-free)

ABSOLUTE MAXIMUM RATINGS T _A = 25 °C, unless otherwise noted				
Parameter	Symbol	10 s	Steady State	Unit
Drain-Source Voltage	V _{DS}	20		V
Gate-Source Voltage	V _{GS}	± 20		
Continuous Drain Current (T _J = 150 °C) ^a	I _D	T _A = 25 °C	21.1	13.5
		T _A = 70 °C	16.9	10.8
Pulsed Drain Current	I _{DM}	60		A
Continuous Source Current (Diode Conduction) ^a	I _S	3.2	1.3	
Single Avalanche Current	L = 0.1 mH	I _{AS}	35	
Single Avalanche Energy			E _{AS}	61
Maximum Power Dissipation ^a	P _D	T _A = 25 °C	3.8	1.5
		T _A = 70 °C	2.0	0.8
Operating Junction and Storage Temperature Range	T _J , T _{stg}	- 55 to 150		°C
Soldering Recommendations (Peak Temperature) ^{b, c}		260		

THERMAL RESISTANCE RATINGS				
Parameter	Symbol	Typical	Maximum	Unit
Maximum Junction-to-Ambient ^a	R _{thJA}	t ≤ 10 s	24	33
		Steady State	65	81
Maximum Junction-to-Case (Drain)	R _{thJC}	1.9	2.4	°C/W

Notes:

- Surface Mounted on 1" x 1" FR4 board.
- See Solder Profile (<http://www.vishay.com/ppg?73257>). The PowerPAK 1212-8 is a leadless package. The end of the lead terminal is exposed copper (not plated) as a result of the singulation process in manufacturing. A solder fillet at the exposed copper tip cannot be guaranteed and is not required to ensure adequate bottom side solder interconnection.
- Rework Conditions: manual soldering with a soldering iron is not recommended for leadless components.

MOSFET SPECIFICATIONS $T_J = 25\text{ }^\circ\text{C}$, unless otherwise noted							
Parameter	Symbol	Test Conditions	Min.	Typ.	Max.	Unit	
Static							
Gate Threshold Voltage	$V_{GS(th)}$	$V_{DS} = V_{GS}, I_D = 250\text{ }\mu\text{A}$	1.5		2.5	V	
Gate-Body Leakage	I_{GSS}	$V_{DS} = 0\text{ V}, V_{GS} = \pm 20\text{ V}$			± 100	nA	
Zero Gate Voltage Drain Current	I_{DSS}	$V_{DS} = 20\text{ V}, V_{GS} = 0\text{ V}$			1	μA	
		$V_{DS} = 20\text{ V}, V_{GS} = 0\text{ V}, T_J = 55\text{ }^\circ\text{C}$			5		
On-State Drain Current ^a	$I_{D(on)}$	$V_{DS} \geq 5\text{ V}, V_{GS} = 10\text{ V}$	40			A	
Drain-Source On-State Resistance ^a	$R_{DS(on)}$	$V_{GS} = 10\text{ V}, I_D = 21.1\text{ A}$		0.0044	0.0053	Ω	
		$V_{GS} = 4.5\text{ V}, I_D = 17.4\text{ A}$		0.0064	0.0078		
Forward Transconductance ^a	g_{fs}	$V_{DS} = 15\text{ V}, I_D = 21.1\text{ A}$		71		S	
Diode Forward Voltage ^a	V_{SD}	$I_S = 3.2\text{ A}, V_{GS} = 0\text{ V}$		0.8	1.2	V	
Dynamic^b							
Total Gate Charge	Q_g	$V_{DS} = 10\text{ V}, V_{GS} = 4.5\text{ V}, I_D = 21.1\text{ A}$		14	21	nC	
Gate-Source Charge	Q_{gs}			7			
Gate-Drain Charge	Q_{gd}			4.5			
Gate Resistance	R_g	$f = 1\text{ MHz}$	0.7	1.4	2.1	Ω	
Turn-On Delay Time	$t_{d(on)}$	$V_{DD} = 10\text{ V}, R_L = 10\text{ }\Omega$ $I_D \cong 1\text{ A}, V_{GEN} = 10\text{ V}, R_g = 6\text{ }\Omega$		12	20	ns	
Rise Time	t_r			10	15		
Turn-Off Delay Time	$t_{d(off)}$			36	55		
Fall Time	t_f			10	15		
Body Diode Reverse Recovery Time	t_{rr}	$I_F = 3.2\text{ A}, di/dt = 100\text{ A}/\mu\text{s}$		30	60	nC	
Body Diode Reverse Recovery Charge	Q_{rr}			25	50		
Reverse Recovery Fall Time	t_a			14			ns
Reverse Recovery Rise Time	t_b			16			

Notes:

- a. Pulse test; pulse width $\leq 300\text{ }\mu\text{s}$, duty cycle $\leq 2\%$.
- b. Guaranteed by design, not subject to production testing.

Stresses beyond those listed under "Absolute Maximum Ratings" may cause permanent damage to the device. These are stress ratings only, and functional operation of the device at these or any other conditions beyond those indicated in the operational sections of the specifications is not implied. Exposure to absolute maximum rating conditions for extended periods may affect device reliability.

TYPICAL CHARACTERISTICS $25\text{ }^\circ\text{C}$, unless otherwise noted

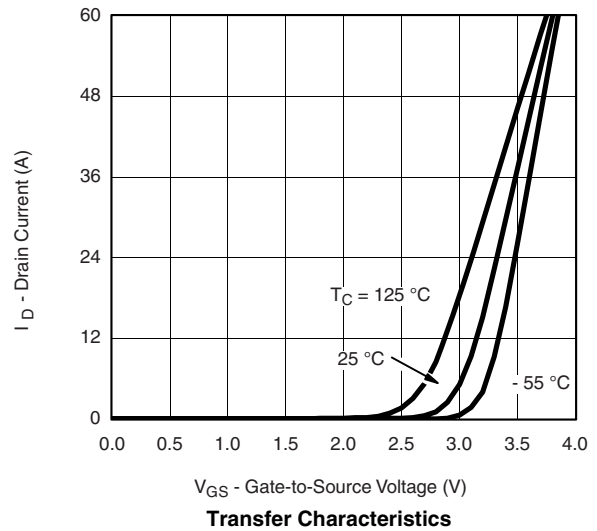
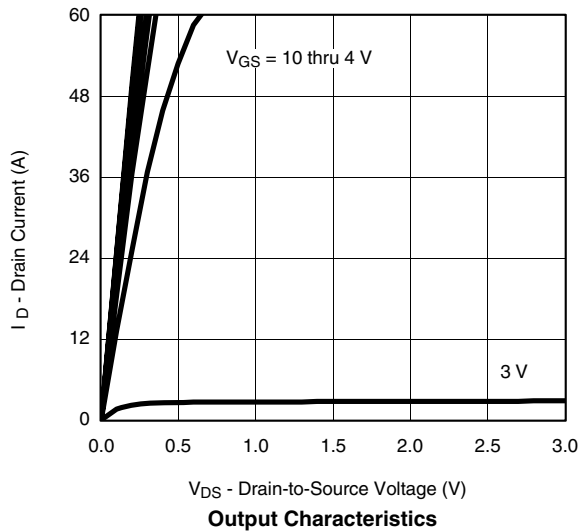

TYPICAL CHARACTERISTICS 25 °C, unless otherwise noted

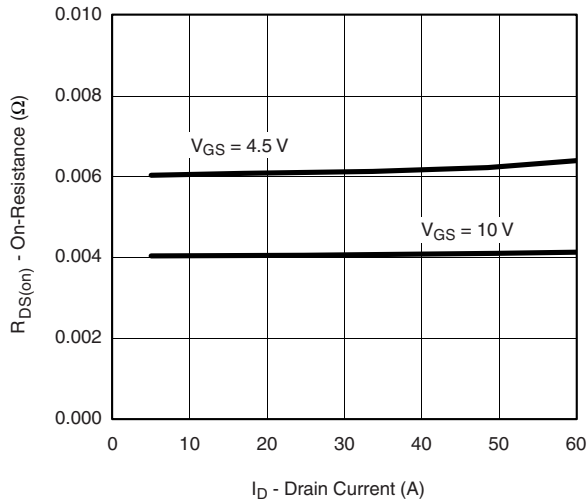

On-Resistance vs. Drain Current

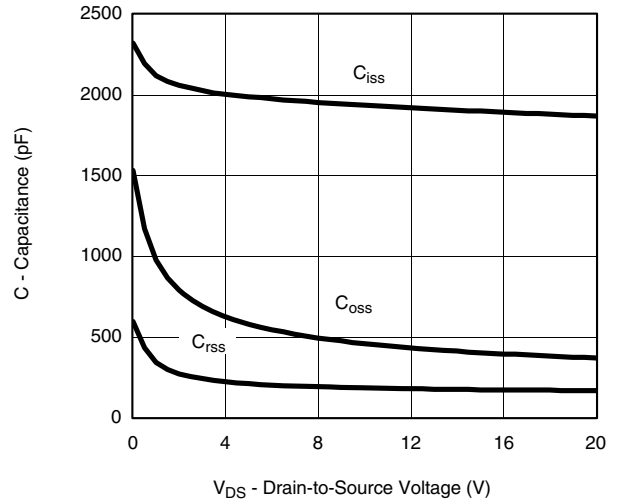

Capacitance

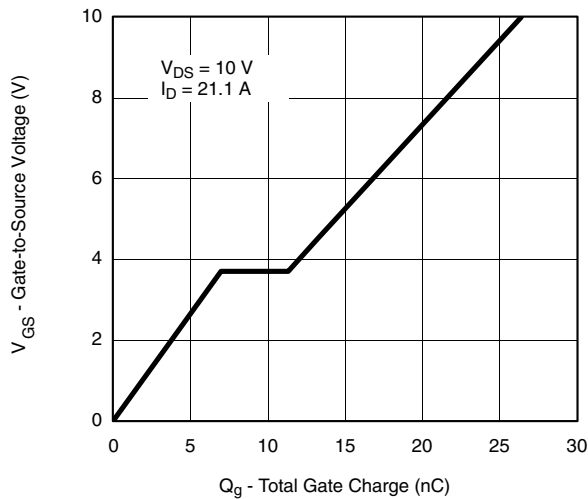

Gate Charge

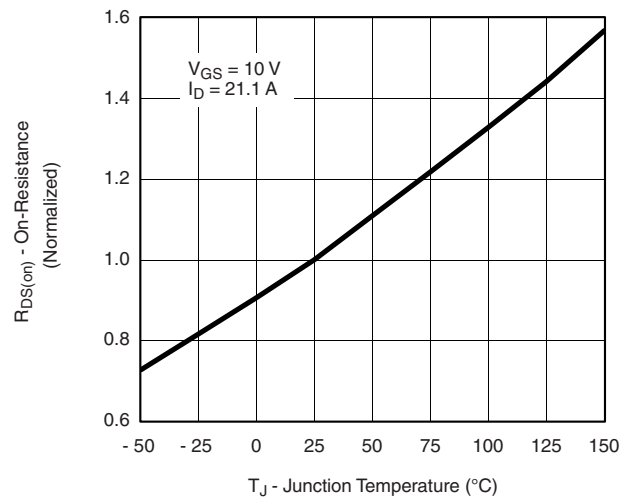

On-Resistance vs. Junction Temperature

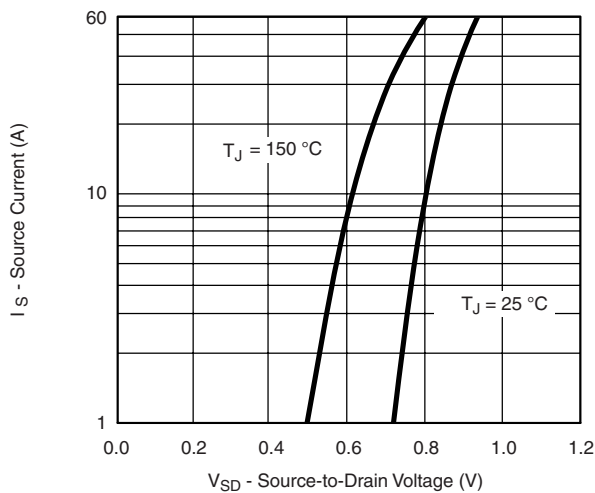

Source-Drain Diode Forward Voltage

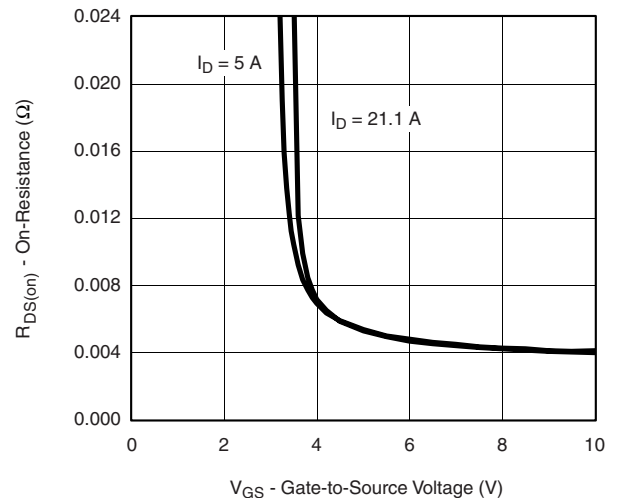

On-Resistance vs. Gate-to-Source Voltage

TYPICAL CHARACTERISTICS 25 °C, unless otherwise noted

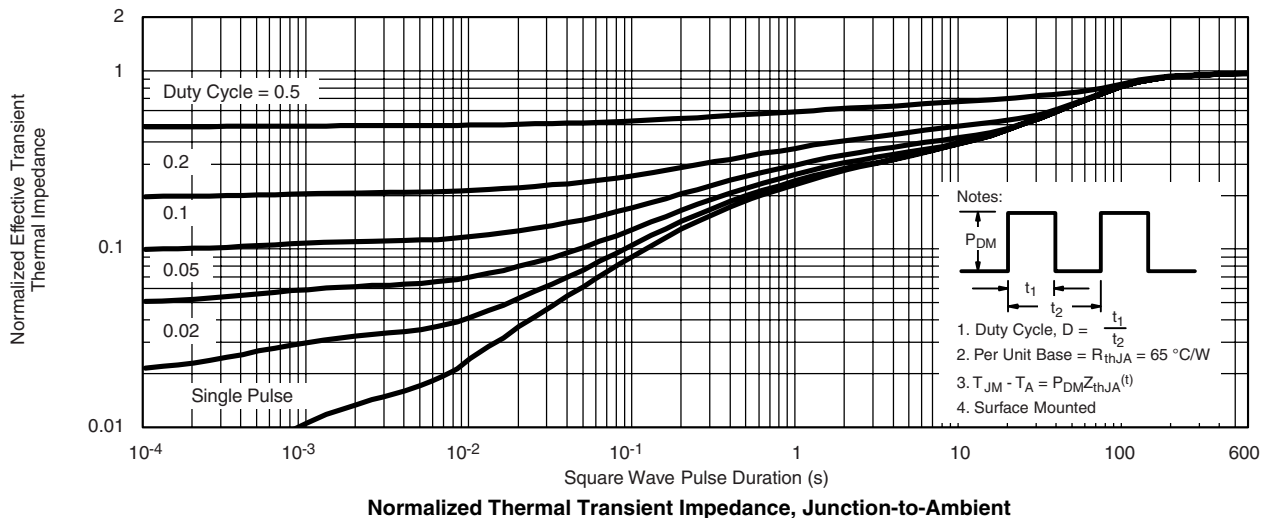
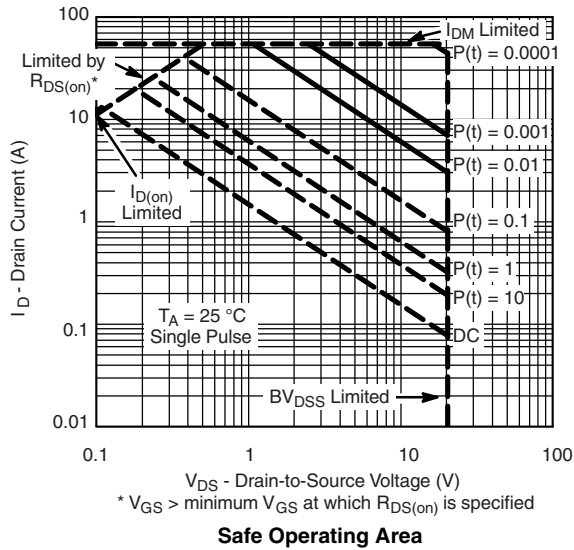
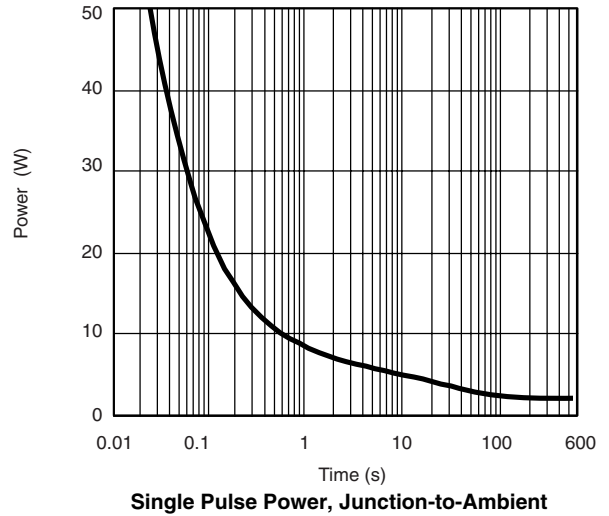
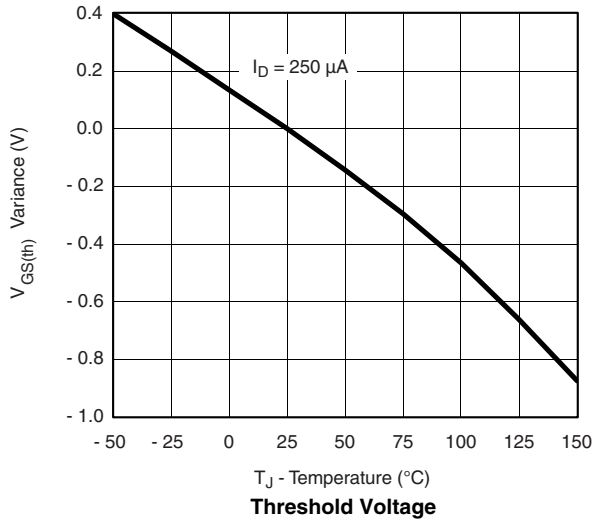

TYPICAL CHARACTERISTICS 25 °C, unless otherwise noted

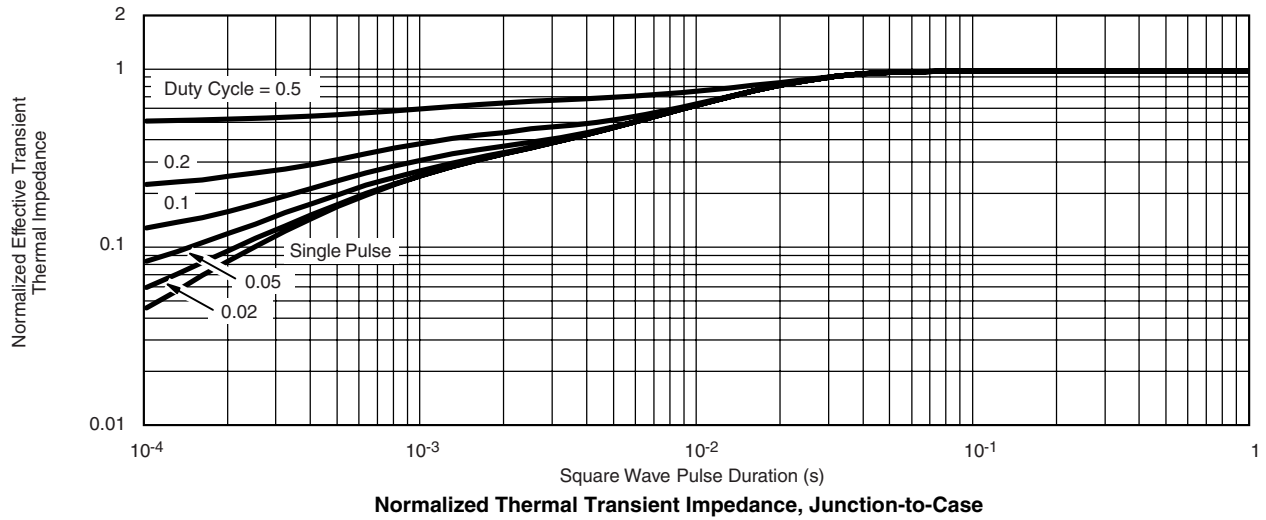

Vishay Siliconix maintains worldwide manufacturing capability. Products may be manufactured at one of several qualified locations. Reliability data for Silicon Technology and Package Reliability represent a composite of all qualified locations. For related documents such as package/tape drawings, part marking, and reliability data, see <http://www.vishay.com/ppg?73143>.



Notice

Specifications of the products displayed herein are subject to change without notice. Vishay Intertechnology, Inc., or anyone on its behalf, assumes no responsibility or liability for any errors or inaccuracies.

Information contained herein is intended to provide a product description only. No license, express or implied, by estoppel or otherwise, to any intellectual property rights is granted by this document. Except as provided in Vishay's terms and conditions of sale for such products, Vishay assumes no liability whatsoever, and disclaims any express or implied warranty, relating to sale and/or use of Vishay products including liability or warranties relating to fitness for a particular purpose, merchantability, or infringement of any patent, copyright, or other intellectual property right.

The products shown herein are not designed for use in medical, life-saving, or life-sustaining applications. Customers using or selling these products for use in such applications do so at their own risk and agree to fully indemnify Vishay for any damages resulting from such improper use or sale.