

Features

- Dual N-Channel MOSFET
- Low On-Resistance
- Low Gate Threshold Voltage
- Low Input Capacitance
- Fast Switching Speed
- Low Input/Output Leakage
- Ultra-Small Surface Mount Package
- **Lead Free By Design/RoHS Compliant (Note 2)**
- **Qualified to AEC-Q101 Standards for High Reliability**
- **"Green" Device (Note 3 and 4)**

Mechanical Data

- Case: SOT-563
- Case Material: Molded Plastic. "Green" Molding Compound. UL Flammability Classification Rating 94V-0
- Moisture Sensitivity: Level 1 per J-STD-020D
- Terminal Connections: See Diagram
- Terminals: Finish - Matte Tin annealed over Alloy 42 or Copper leadframe. Solderable per MIL-STD-202, Method 208
- Terminals: Lead bearing terminal plating available. See Ordering Information Page 3, Note 8
- Marking Information: See Page 3
- Ordering Information: See Page 3
- Weight: 0.006 grams (approximate)



TOP VIEW

SOT-563

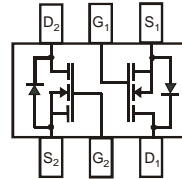
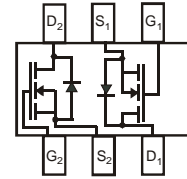
 2N7002V
(KAS or ASK Marking Code)

 2N7002VA
(KAY or AYK Marking Code)

Maximum Ratings @ $T_A = 25^\circ\text{C}$ unless otherwise specified

Characteristic	Symbol	Value	Units
Drain-Source Voltage	V_{DS}	60	V
Drain-Gate Voltage $R_{GS} \leq 1.0M\Omega$	V_{DGR}	60	V
Gate-Source Voltage	V_{GSS}	± 20 ± 40	V
Drain Current (Note 1)	I_D	280	mA
Drain Current (Note 1)	I_{DM}	1.5	A

Thermal Characteristics @ $T_A = 25^\circ\text{C}$ unless otherwise specified

Characteristic	Symbol	Value	Units
Total Power Dissipation	P_D	150	mW
Thermal Resistance, Junction to Ambient	$R_{\theta JA}$	833	$^\circ\text{C/W}$
Operating and Storage Temperature Range	T_J, T_{STG}	-55 to +150	$^\circ\text{C}$

- Notes:
1. Device mounted on FR-4 PCB, 1 inch x 0.85 inch x 0.062 inch; pad layout as shown on Diodes Inc. suggested pad layout document AP02001, which can be found on our website at <http://www.diodes.com/datasheets/ap02001.pdf>.
 2. No purposefully added Lead.
 3. Diodes Inc.'s "Green" policy can be found on our website at http://www.diodes.com/products/lead_free/index.php.
 4. Product manufactured with Date Code UO (week 40, 2007) and newer are built with Green Molding Compound. Product manufactured prior to Date Code UO are built with Non-Green Molding Compound and may contain Halogens or Sb2O3 Fire Retardants.

Electrical Characteristics @T_A = 25°C unless otherwise specified

Characteristic	Symbol	Min	Typ	Max	Unit	Test Condition
OFF CHARACTERISTICS (Note 5)						
Drain-Source Breakdown Voltage	BV _{DSS}	60	70	—	V	V _{GS} = 0V, I _D = 10μA
Zero Gate Voltage Drain Current	I _{DSS}	—	—	1.0 500	μA	@ T _C = 25°C @ T _C = 125°C V _{DS} = 60V, V _{GS} = 0V
Gate-Body Leakage	I _{GSS}	—	—	±100	nA	V _{GS} = ±20V, V _{DS} = 0V
ON CHARACTERISTICS (Note 5)						
Gate Threshold Voltage	V _{GS(th)}	1.0	—	2.5	V	V _{DS} = V _{GS} , I _D = 250μA
Static Drain-Source On-Resistance	R _{DS(ON)}	—	—	7.5 13.5	Ω	V _{GS} = 5V, I _D = 0.05A, V _{GS} = 10V, I _D = 0.5A, T _J = 125°C
On-State Drain Current	I _{D(ON)}	0.5	1.0	—	A	V _{GS} = 10V, V _{DS} = 7.5V
Forward Transconductance	g _{FS}	80	—	—	mS	V _{DS} = 10V, I _D = 0.2A
DYNAMIC CHARACTERISTICS						
Input Capacitance	C _{iss}	—	—	50	pF	V _{DS} = 25V, V _{GS} = 0V, f = 1.0MHz
Output Capacitance	C _{oss}	—	—	25	pF	
Reverse Transfer Capacitance	C _{rss}	—	—	5.0	pF	
SWITCHING CHARACTERISTICS						
Turn-On Delay Time	t _{D(ON)}	—	—	20	ns	V _{DD} = 30V, I _D = 0.2A, R _L = 150Ω, V _{GEN} = 10V, R _{GEN} = 25Ω
Turn-Off Delay Time	t _{D(OFF)}	—	—	20	ns	

Notes: 5. Short duration pulse test used to minimize self-heating effect.

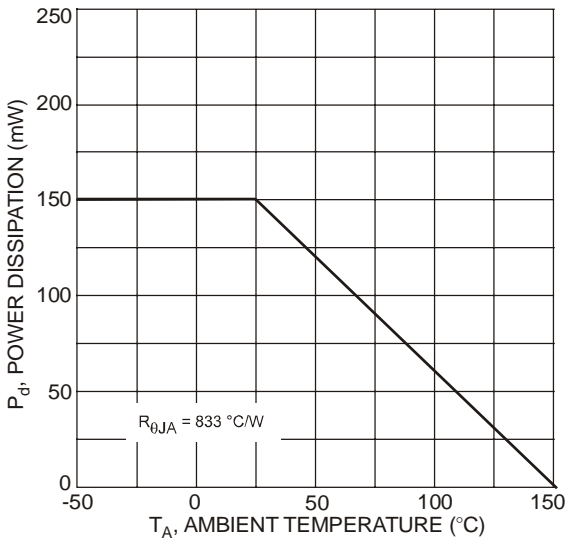

Fig. 1, Derating Curve - Total

Ordering Information (Notes 6 and 7)

Part Number	Case	Packaging
2N7002V-7	SOT-563	3000/Tape & Reel
2N7002VA-7	SOT-563	3000/Tape & Reel
2N7002V-7-L	SOT-563	3000/Tape & Reel
2N7002VA-7-L	SOT-563	3000/Tape & Reel

Notes: 6. For packaging details, go to our website at <http://www.diodes.com/datasheets/ap02007.pdf>.
7. "-L" suffix on part number indicates Pb/Sn terminal plating. "-L" version is a Non Lead-Free, Non RoHS-compliant device.

Marking Information (Note 8)

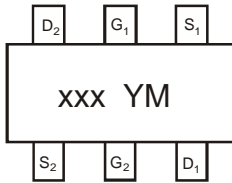

xxx = KAS or ASK
(2N7002V Product Type Marking Code)
YM = Date Code Marking
Y = Year ex: R = 2004
M = Month ex: 9 = September

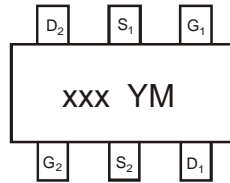

xxx = KAY or AYK
(2N7002VA Product Type Marking Code)
YM = Date Code Marking
Y = Year ex: R = 2004
M = Month ex: 9 = September

Notes: 8. Package is non-polarized. Parts may be on reel in orientation illustrated, 180° rotated, or mixed (both ways).

Date Code Key

Year	2004	2005	2006	2007	2008	2009	2010	2011	2012
Code	R	S	T	U	V	W	X	Y	Z

Month	Jan	Feb	Mar	Apr	May	Jun	Jul	Aug	Sep	Oct	Nov	Dec
Code	1	2	3	4	5	6	7	8	9	O	N	D

Package Outline Dimensions

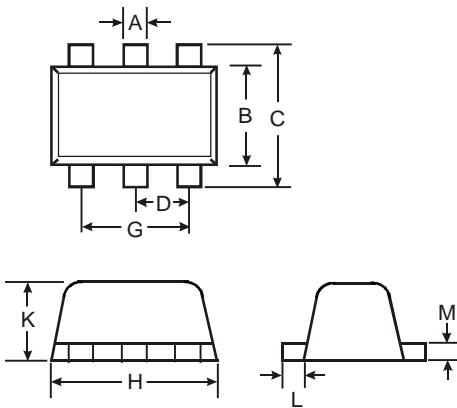

SOT-563			
Dim	Min	Max	Typ
A	0.15	0.30	0.20
B	1.10	1.25	1.20
C	1.55	1.70	1.60
D	0.50		
G	0.90	1.10	1.00
H	1.50	1.70	1.60
K	0.55	0.60	0.60
L	0.10	0.30	0.20
M	0.10	0.18	0.11
All Dimensions in mm			

Suggested Pad Layout

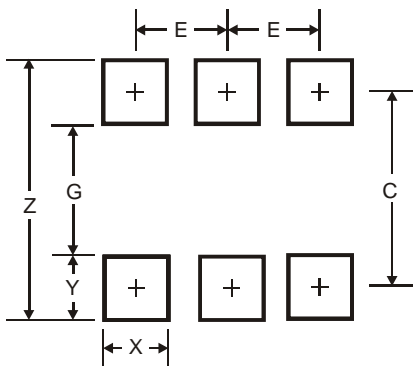

Dimensions	Value (in mm)
Z	2.2
G	1.2
X	0.375
Y	0.5
C	1.7
E	0.5

IMPORTANT NOTICE

Diodes Incorporated and its subsidiaries reserve the right to make modifications, enhancements, improvements, corrections or other changes without further notice to any product herein. Diodes Incorporated does not assume any liability arising out of the application or use of any product described herein; neither does it convey any license under its patent rights, nor the rights of others. The user of products in such applications shall assume all risks of such use and will agree to hold Diodes Incorporated and all the companies whose products are represented on our website, harmless against all damages.

LIFE SUPPORT

Diodes Incorporated products are not authorized for use as critical components in life support devices or systems without the expressed written approval of the President of Diodes Incorporated.