

DISCRIPTION

2SC3240 is a silicon NPN epitaxial planar type transistor specifically designed for high power amplifiers in HF band.

FEATURES

- High gain: $G_{pe} \geq 11.5\text{dB}$, $P_o \geq 100\text{W}$
@f = 30MHz, $V_{CC} = 12.5\text{V}$, $P_{in} = 7\text{W}$
- High ruggedness: Ability to withstand 20:1 load VSWR when operated at f = 30MHz, $P_o = 100\text{W}$, $V_{CC} = 15.2\text{V}$.
- Emitter ballasted construction
- Low thermal resistance ceramic package with flange.
Input-output impedance
 $Z_{in} = 0.4 - j0.8 (\Omega)$
 $Z_{out} = 1.0 - j1.1 (\Omega)$
@f = 30MHz, $V_{CC} = 12.5\text{V}$, $P_o = 100\text{W}$

APPLICATION

Output stage of transmitter in HF band SSB mobile radio sets.

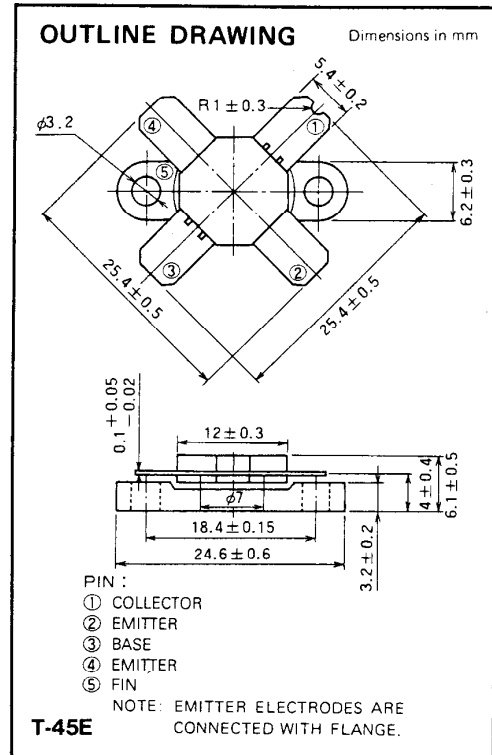

ABSOLUTE MAXIMUM RATINGS ($T_C = 25^\circ\text{C}$ unless otherwise specified)

Symbol	Parameter	Conditions	Ratings	Unit
V_{CB0}	Collector to base voltage		50	V
V_{EB0}	Emitter to base voltage		5	V
V_{CE0}	Collector to emitter voltage	$R_{BE} = \infty$	20	V
I_C	Collector current		25	A
P_C	Collector dissipation	$T_a = 25^\circ\text{C}$	8	W
		$T_C = 25^\circ\text{C}$	270	W
T_j	Junction temperature		175	$^\circ\text{C}$
T_{stg}	Storage temperature		-55 to 175	$^\circ\text{C}$
R_{th-a}	Thermal resistance	Junction to ambient	18.7	$^\circ\text{C/W}$
R_{th-c}		Junction to case	0.556	$^\circ\text{C/W}$

Note. Above parameters are guaranteed independently.

ELECTRICAL CHARACTERISTICS ($T_C = 25^\circ\text{C}$ unless otherwise specified)

Symbol	Parameter	Test conditions	Limits			Unit
			Min	Typ	Max	
$V_{(BR)EB0}$	Emitter to base breakdown voltage	$I_E = 20\text{mA}$, $I_C = 0$	5			V
$V_{(BR)CB0}$	Collector to base breakdown voltage	$I_C = 20\text{mA}$, $I_E = 0$	50			V
$V_{(BR)CE0}$	Collector to emitter breakdown voltage	$I_C = 100\text{mA}$, $R_{BE} = \infty$	20			V
I_{CB0}	Collector cutoff current	$V_{CB} = 15\text{V}$, $I_E = 0$			5	mA
I_{EB0}	Emitter cutoff current	$V_{EB} = 3\text{V}$, $I_C = 0$			5	mA
h_{FE}	DC forward current gain*	$V_{CE} = 10\text{V}$, $I_C = 1\text{A}$	10	50	180	—
P_o	Output power	$f = 30\text{MHz}$, $V_{CC} = 12.5\text{V}$, $P_{in} = 7\text{W}$	100	110		W
η_C	Collector efficiency		55	60		%

Note. * Pulse test, $P_w = 150\mu\text{s}$, duty = 5%.
Above parameters, ratings, limits and conditions are subject to change.

TEST CIRCUIT

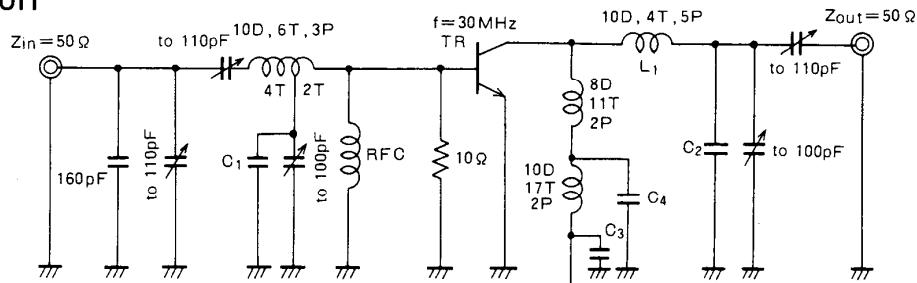

- C₁: 160pF, 160pF, 82pF in parallel
 - C₂: 82pF, 82pF, 82pF in parallel
 - C₃: 100pF, 4700pF, 4700pF, 0.22μF, 0.22μF, 33μF, 330μF in parallel
 - C₄: 100pF, 220pF, 4700pF, 0.1μF, 330μF in parallel
- RFC: 27 Turns 1φ enameled wire

NOTES: All coils but L₁ are made from 1.5φmm silver plated copper wire, L₁ is made from 2.3φmm copper wire.
 D: Inner diameter of coil
 T: Turn number of coil
 P: Pitch of coil
 Dimension in milli-meter

TYPICAL PERFORMANCE DATE

COLLECTOR DISSIPATION VS. AMBIENT TEMPERATURE

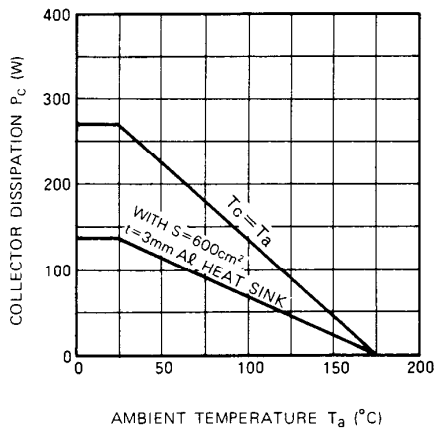

DC CURRENT GAIN VS. COLLECTOR CURRENT

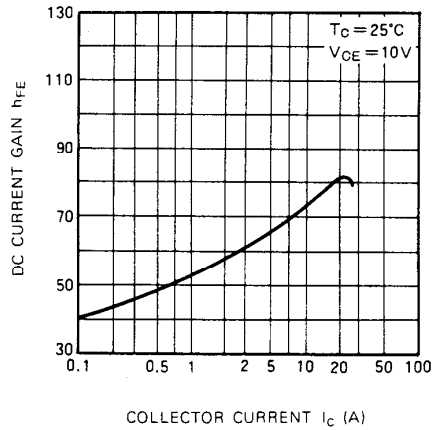

COLLECTOR OUTPUT CAPACITANCE VS. COLLECTOR TO BASE VOLTAGE

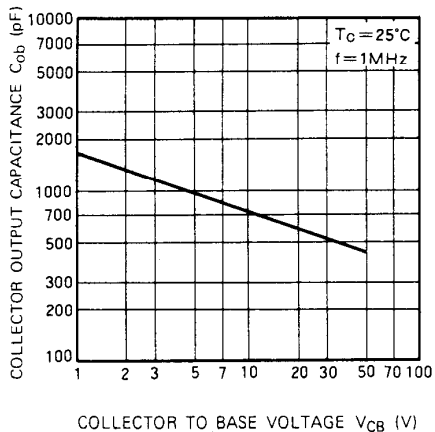

OUTPUT POWER, COLLECTOR EFFICIENCY VS. INPUT POWER

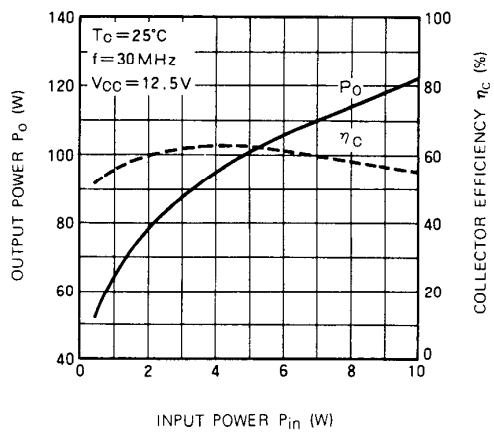

NPN EPITAXIAL PLANAR TYPE

OUTPUT POWER VS. COLLECTOR SUPPLY VOLTAGE

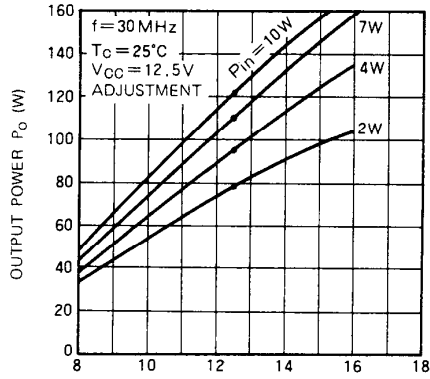

COLLECTOR SUPPLY VOLTAGE V_{cc} (V)

COLLECTOR TO EMITTER BREAKDOWN VOLTAGE VS. BASE TO EMITTER RESISTANCE

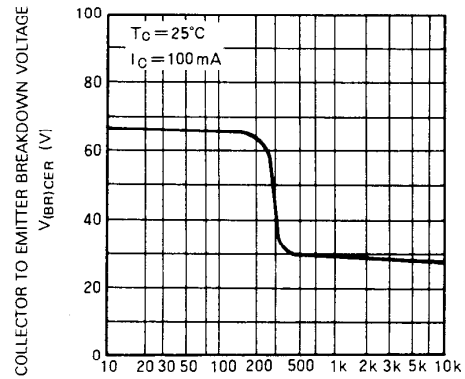

BASE TO EMITTER RESISTANCE R_{BE} (Ω)

COLLECTOR CURRENT VS. COLLECTOR TO EMITTER VOLTAGE

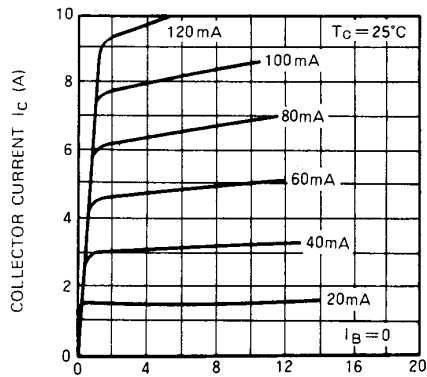

COLLECTOR TO EMITTER VOLTAGE (V)