



CHENMKO ENTERPRISE CO.,LTD

2SC4097PT

SURFACE MOUNT

Medium Power NPN Transistor

VOLTAGE 32 Volts CURRENT 0.5 Ampere

Lead free devices

APPLICATION

* Medium Power Amplifier .

FEATURE

- * Surface mount package. (SC-70/SOT-323)
- * Low saturation voltage V
- * Low cob. Cob=6.0pF(Typ) $V_{CE(sat)}=0.4V(max.)$ (Ic=500mA)
- * Pc= 200mW (mounted on ceramic substrate).
- * High saturation current capability.

CONSTRUCTION

- * NPN Silicon Transistor
- * Epitaxial planner type

MARKING

- * HFE(P):PT
- * HFE(Q):NE
- * HFE(R):RA

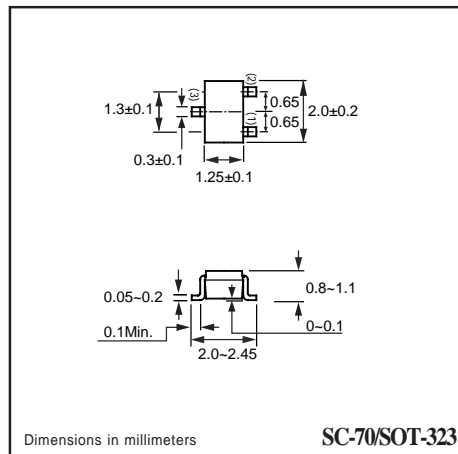
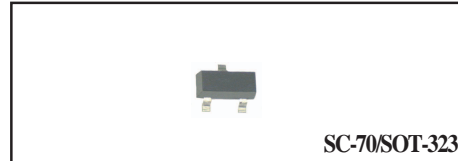

CIRCUIT

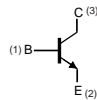

MAXIMUM RATINGS (At TA = 25°C unless otherwise noted)

RATINGS	CONDITION	SYMBOL	MIN.	MAX.	UNITS
Collector - Base Voltage	Open Emitter	V _{CB0}	-	40	Volts
Collector - Emitter Voltage	Open Base	V _{CE0}	-	32	Volts
Emitter - Base Voltage	Open Collector	V _{EB0}	-	5	Volts
Collector Current DC		I _c	-	500	mAmps
Peak Collector Current		I _{CM}	-	500	mAmps
Peak Base Current		I _{BM}	-	10	mAmps
Total Power Dissipation	T _A ≤ 25°C; Note 1	P _{TOT}	-	250	mW
Storage Temperature		T _{STG}	-55	+150	°C
Junction Temperature		T _J	-	+150	°C
Operating Ambient Temperature		T _{AMB}	-55	+150	°C

Note

1. Transistor mounted on ceramic substrate 50mmX50mmX0.8t.
2. Measured at Pulse Width 300 us, Duty Cycle 2%.

2002-10

RATING CHARACTERISTICS (2SC4097PT)

ELECTRICAL CHARACTERISTICS (At $T_A = 25^\circ\text{C}$ unless otherwise noted)

PARAMETERS	CONDITION	SYMBOL	MIN.	TYPE	MAX.	UNITS
Collector Cut-off Current	$I_E=0; V_{CB}=20\text{V}$	I_{CBO}	-	-	1.0	μA
Emitter Cut-off Current	$I_C=0; V_{EB}=4\text{V}$	I_{CEO}	-	-	1.0	μA
DC Current Gain	$V_{CE}=3\text{V}$; Note 1 $I_C=100\text{mA}$; Note 2	h_{FE}	82	-	390	
Collector-Emitter Saturation Voltage	$I_C=500\text{mA}; I_B=50\text{mA}$	V_{CEsat}	-	-	0.4	Volts
Base-Emitter Saturatio Voltage	$I_C=500\text{mA}; I_B=50\text{mA}$	V_{BEsat}	-	-	1.1	mVolts
Output Collector Capacitance	$I_E=I_C=0; V_{CB}=12\text{V}; f=1\text{MHz}$	C_{ob}	-	6.0	-	pF
Transition Frequency	$I_C=20\text{mA}; V_{CE}=5\text{V}; f=100\text{MHz}$	f_T	-	250	-	MHz

Note :

1. Pulse test: $t_p \leq 300\mu\text{Sec}$; $\delta \leq 0.02$.
2. h_{FE} : Classification P: 82 to 180, Q: 120 to 270, R: 180 to 390,

RATING CHARACTERISTIC CURVES (2SC4097PT)

Fig.1 Grounded emitter propagation characteristics

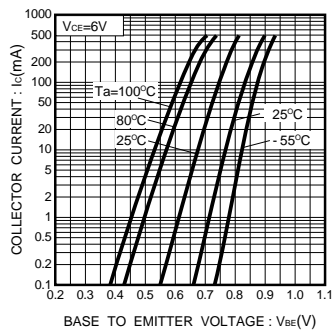

Fig.2 Grounded emitter output characteristics (1)

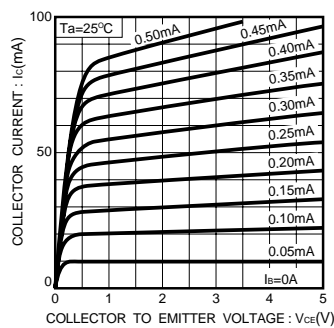
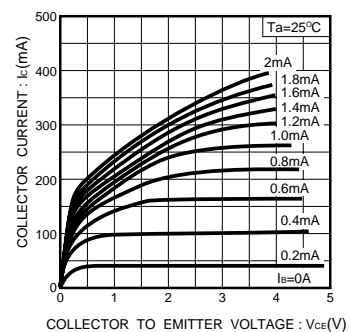

Fig.3 Grounded emitter output characteristics (2)



RATING CHARACTERISTIC CURVES (2SC4097PT)

Fig.4 Collector-emitter saturation voltage vs. collector current

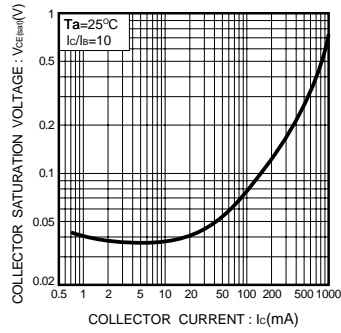

Fig.5 DC current gain vs. collector current

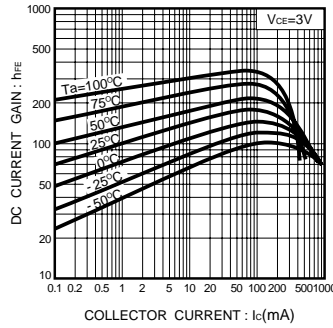

Fig. 6 Gain bandwidth product vs. emitter current

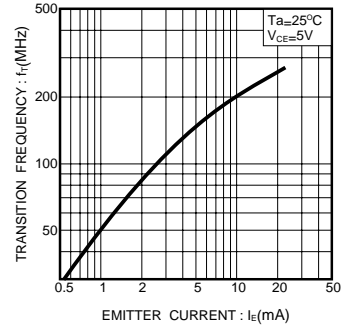

Fig.7 Collector output capacitance vs. collector-base voltage
Emitter input capacitance vs. emitter-base voltage

