



WBFBP-03A Plastic-Encapsulate Transistors

2SC4115E TRANSISTOR

DESCRIPTION

NPN Epitaxial planar Silicon Transistor

FEATURES

Low $V_{CE(sat)}$. $V_{CE(sat)} = 0.2V$ (Typ.) ($I_C/I_B = 2A/0.1A$)

APPLICATION

Excellent current gain characteristics

For portable equipment:(i.e. Mobile phone,MP3, MD,CD-ROM, DVD-ROM, Note book PC, etc.)

MARKING:CFQ, CFR, CFS

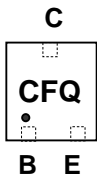

MAXIMUM RATINGS $T_A=25^\circ C$ unless otherwise noted

Symbol	Parameter	Value	Units
V_{CBO}	Collector-Base Voltage	40	V
V_{CEO}	Collector-Emitter Voltage	20	V
V_{EBO}	Emitter-Base Voltage	6	V
I_C	Collector Current -Continuous	3	A
P_D	Total Device Dissipation	150	mW
T_J	Junction Temperature	150	$^\circ C$
T_{stg}	Storage Temperature	-55-150	$^\circ C$

ELECTRICAL CHARACTERISTICS ($T_{amb}=25^\circ C$ unless otherwise specified)

Parameter	Symbol	Test conditions	MIN	TYP	MAX	UNIT
Collector-base breakdown voltage	$V_{(BR)CBO}$	$I_C = 50\mu A, I_E = 0$	40			V
Collector-emitter breakdown voltage	$V_{(BR)CEO}$	$I_C = 1mA, I_B = 0$	20			V
Emitter-base breakdown voltage	$V_{(BR)EBO}$	$I_E = 50\mu A, I_C = 0$	6			V
Collector cut-off current	I_{CBO}	$V_{CB} = 30V, I_E = 0$			0.1	μA
Emitter cut-off current	I_{EBO}	$V_{EB} = 5V, I_C = 0$			0.1	μA
DC current gain	h_{FE}	$V_{CE} = 2V, I_C = 0.1A$	120		560	
Collector-emitter saturation voltage*	V_{CEsat}	$I_C = 2A, I_B = 0.1A$			0.5	V
Transition frequency	f_T	$V_{CE} = 2V, I_C = 0.5A$ $f = 100MHz$		290		MHz
Collector output capacitance	C_{obo}	$V_{CB} = 10V, I_E = 0, f = 1MHz$		25		pF

CLASSIFICATION OF h_{FE}

Rank	Q	R	S
Range	120-270	180-390	270-560

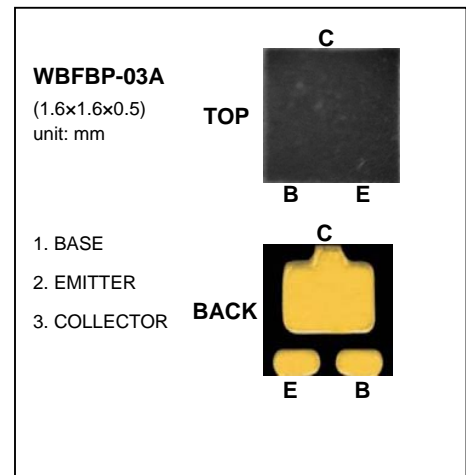

Typical Characteristics

2SC4115E

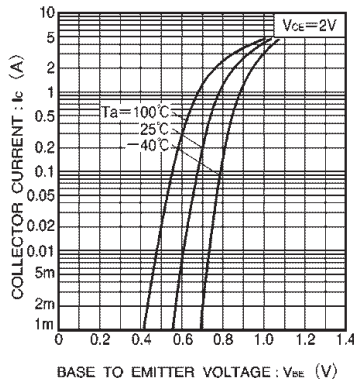

Fig.1 Grounded emitter propagation characteristics

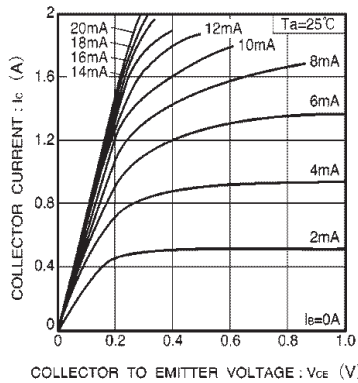

Fig.2 Grounded emitter output characteristics (I)

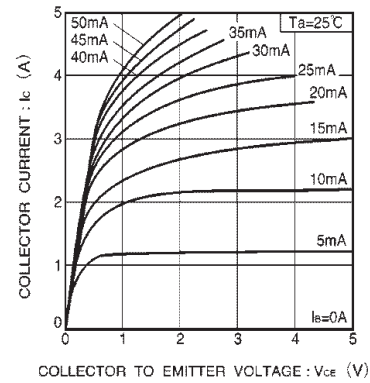

Fig.3 Grounded emitter output characteristics (II)

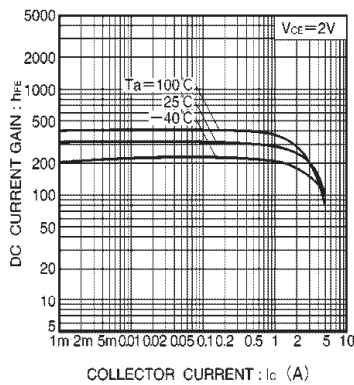

Fig.4 DC current gain vs. collector current

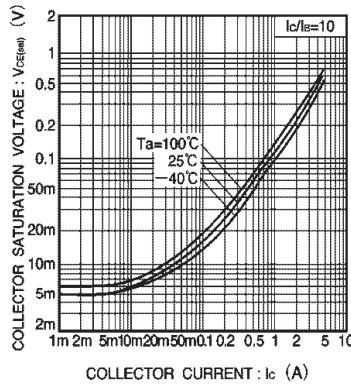

Fig.5 Collector-emitter saturation voltage vs. collector current (I)

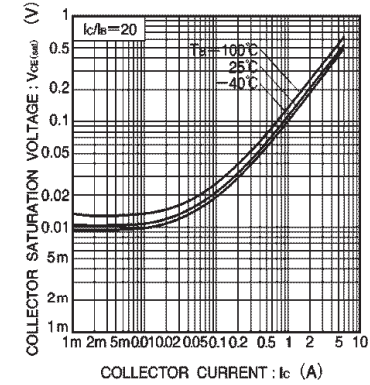

Fig.6 Collector-emitter saturation voltage vs. collector current (II)

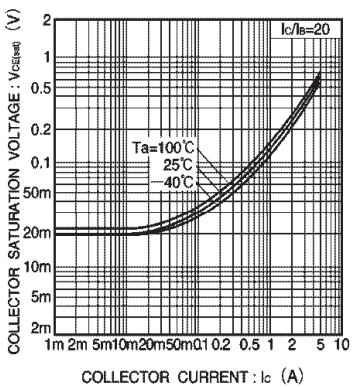

Fig.7 Collector-emitter saturation voltage vs. collector current (III)

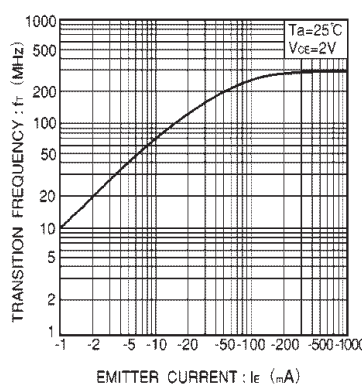

Fig.8 Gain bandwidth product vs. emitter current

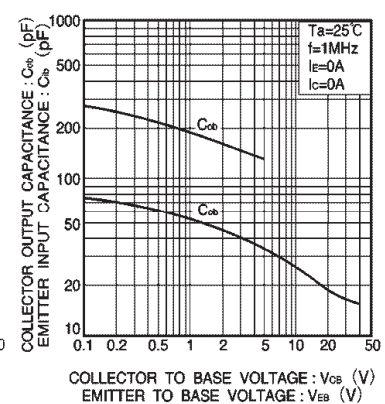
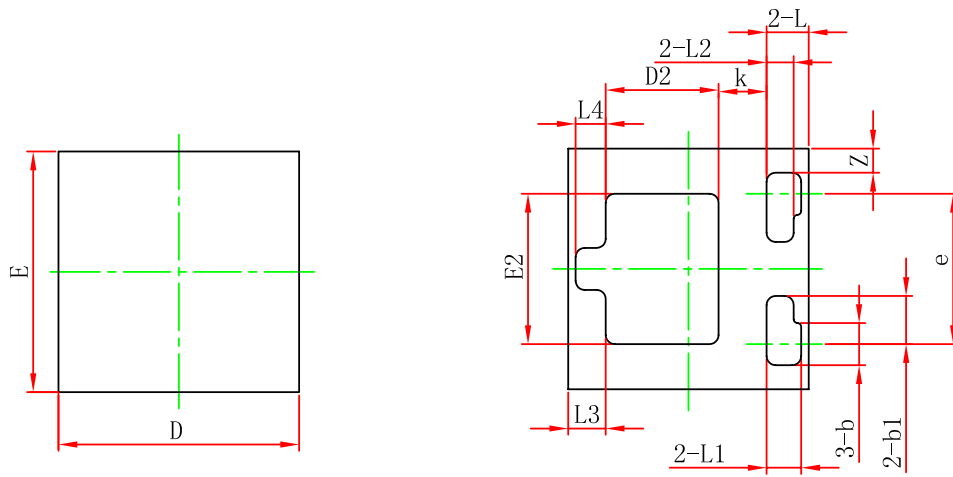

Fig.9 Collector output capacitance vs. collector-base voltage
Emitter input capacitance vs. emitter-base voltage

WFBFP-03A(1.6×1.6×0.5) PACKAGE OUTLINE DIMENSIONS



TOP VIEW

BOTTOM VIEW

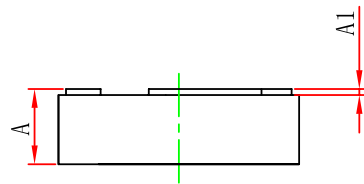

SIDE VIEW

(LAND PATTERN RECOMMENDATION)

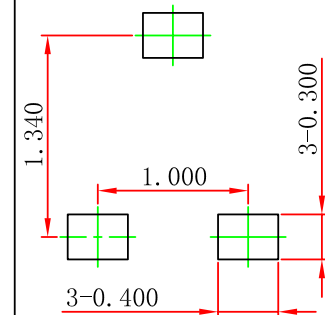

Symbol	Dimensions In Millimeters		Dimensions In Inches	
	Min.	Max.	Min.	Max.
A	0.450	0.550	0.018	0.022
A1	0.010	0.090	0.000	0.004
b	0.230	0.330	0.009	0.013
b1	0.320 REF.		0.013 REF.	
D	1.550	1.650	0.061	0.065
E	1.550	1.650	0.061	0.065
D2	0.750 REF.		0.030 REF.	
E2	1.000 REF.		0.040 REF.	
e	1.000 TYP.		0.040 TYP.	
L	0.280 REF.		0.011 REF.	
L1	0.230 REF.		0.009 REF.	
L2	0.180 REF.		0.007 REF.	
L3	0.250 REF.		0.010 REF.	
L4	0.200 REF.		0.008 REF.	
k	0.320 REF.		0.013 REF.	
z	0.160 REF.		0.006 REF.	