

# NUF4105FC

## 4 Channel EMI Pi-Filter Array with ESD Protection +4 ESD Diodes

This device is a 4 channel EMI filter array for data lines. Greater than -40 dB attenuation is obtained at frequencies from 800 MHz to 2.2 GHz. It also offers ESD protection – clamping transients from static discharges to protect delicate data line circuitry. It is offered in 300  $\mu\text{m}$  and 350  $\mu\text{m}$  solder spheres.

### Features

- EMI Filtering and ESD Protection for Data Lines
- Integration of 26 Discretes Offers Cost and Space Savings
- Exceeds IEC61000-4-2 (Level 4) Specifications
- Low Profile Flip-Chip Packaging
- MSL 1
- 300  $\mu\text{m}$  Solder Spheres (NUF4105), Case 499D

### Typical Applications

- EMI Filtering and ESD Protection for Data Lines
- Cell Phones
- Handheld Portables
- Notebook Computers
- MP3 Players

### MAXIMUM RATINGS ( $T_A = 25^\circ\text{C}$ )

Rating	Symbol	Value	Unit
ESD Discharge IEC61000-4-2, – Air Discharge – Contact Discharge Human Body Model	$V_{PP}$	30 30 16	kV
DC Power per Resistor	$P_R$	100	mW
DC Power per Package	$P_T$	400	mW
Junction Temperature	$T_J$	150	$^\circ\text{C}$
Operating Temperature Range	$T_{Op}$	-40 to +85	$^\circ\text{C}$
Storage Temperature Range	$T_{stg}$	-55 to +150	$^\circ\text{C}$

Maximum ratings are those values beyond which device damage can occur. Maximum ratings applied to the device are individual stress limit values (not normal operating conditions) and are not valid simultaneously. If these limits are exceeded, device functional operation is not implied, damage may occur and reliability may be affected.



ON Semiconductor®

<http://onsemi.com>

### CIRCUIT DESCRIPTION

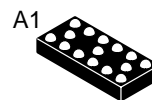
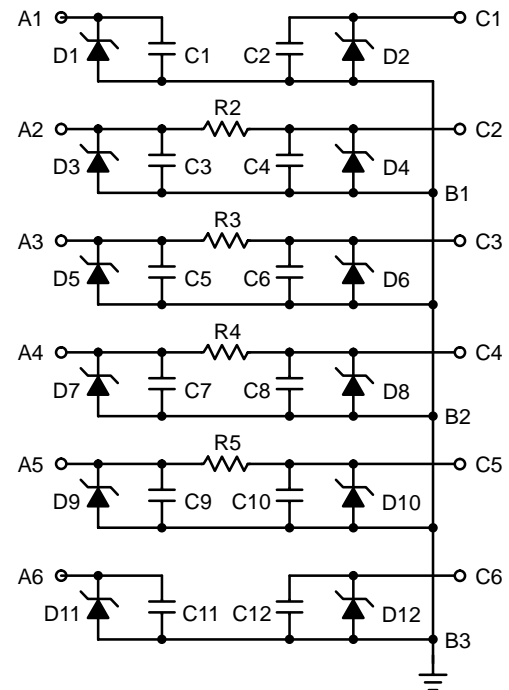

**FLIP-CHIP  
CASE 499D  
300  $\mu\text{m}$  Bumps**

### DEVICE MARKING

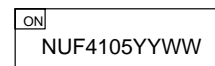

YY = Year  
WW = Work Week

### ORDERING INFORMATION

Device	Package	Shipping†
NUF4105FCT1	Flip-Chip	3000/Tape & Reel

†For information on tape and reel specifications, including part orientation and tape sizes, please refer to our Tape and Reel Packaging Specification Brochure, BRD8011/D.

# NUF4105FC

## ELECTRICAL CHARACTERISTICS ( $T_A = 25^\circ\text{C}$ unless otherwise noted)

Symbol	Characteristic	Min	Typ	Max	Unit
$V_{BR}$	$I_Z = 10 \text{ mA}$	6.0	7.0	8.0	V
$I_R$	$V_{RM} = 3.3 \text{ V per line}$	–	–	0.1	$\mu\text{A}$
$R_{I/O}$	$I_R = 20 \text{ mA}$	80	100	120	$\Omega$
$C_{line}$	$V_R = 2.5 \text{ V}, f = 1.0 \text{ MHz}$ (Note 1)	–	53	–	pF

1. Measured from input/output pins to ground.

## TYPICAL PERFORMANCE CURVES

( $T_A = 25^\circ\text{C}$  unless otherwise specified)

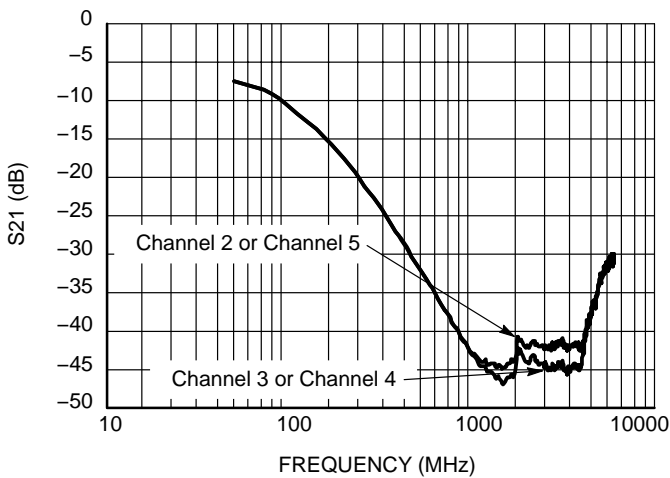

Figure 1. Insertion Loss Curve

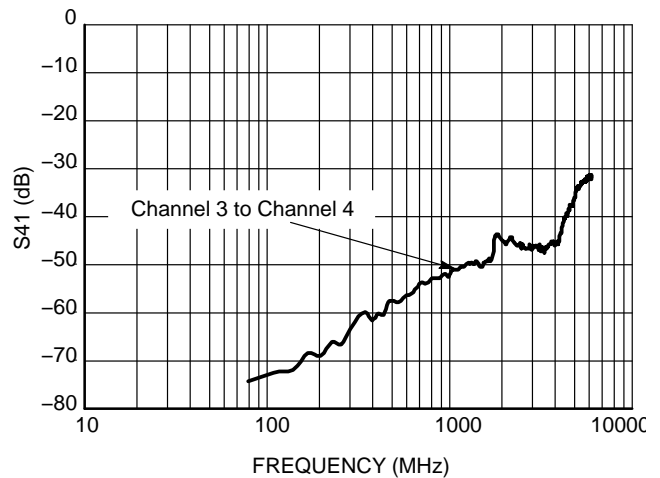

Figure 2. Analog Crosstalk Curve

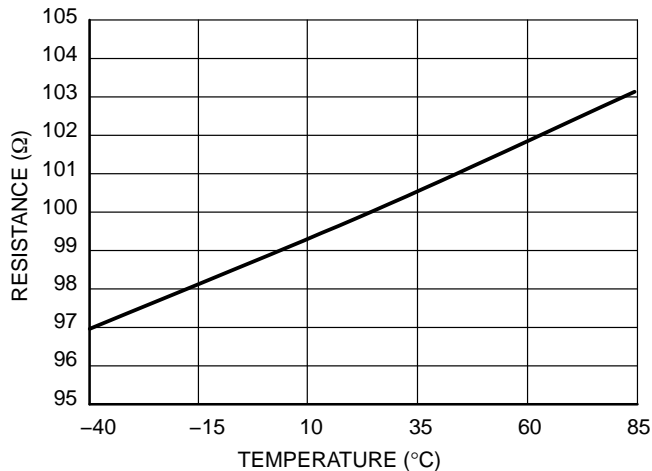

Figure 3. Resistance Over Temperature

# NUF4105FC

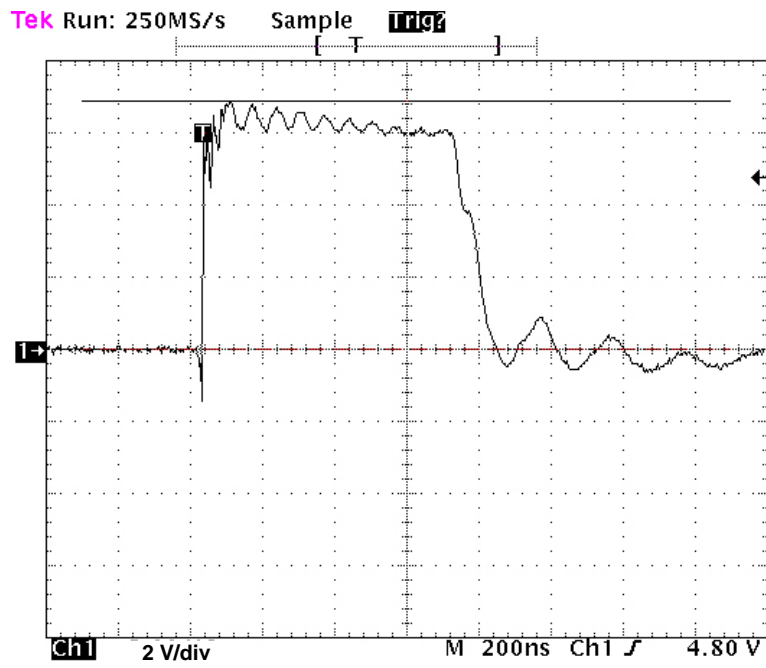

Figure 4. ESD Response for Human Body Model (+8.0 kV)

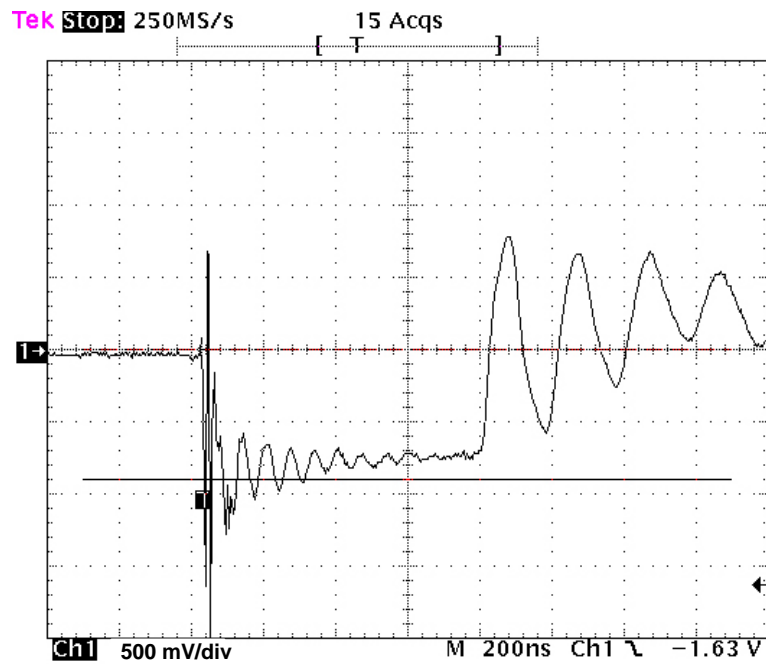

Figure 5. ESD Response for Human Body Model (-8.0 kV)

# NUF4105FC

## Printed Circuit Board Recommendations

Parameter	500 $\mu\text{m}$ Pitch 300 or 350 $\mu\text{m}$ Solder Ball
PCB Pad Size	250 $\mu\text{m}$ +25 -0
Pad Shape	Round
Pad Type	NSMD
Solder Mask Opening	350 $\mu\text{m}$ $\pm$ 25
Solder Stencil Thickness	125 $\mu\text{m}$
Stencil Aperture	250 x 250 $\mu\text{m}$ sq.
Solder Flux Ratio	50/50
Solder Paste Type	No Clean Type 3 or Finer
Trace Finish	OSP Cu
Trace Width	150 $\mu\text{m}$ Max

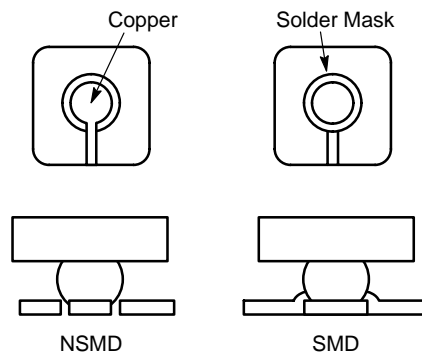

Figure 6. Solder Mask versus Non-Solder Mask Definition

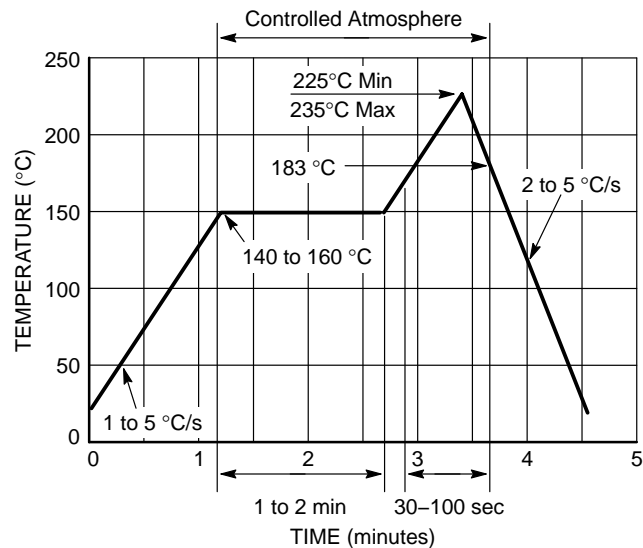
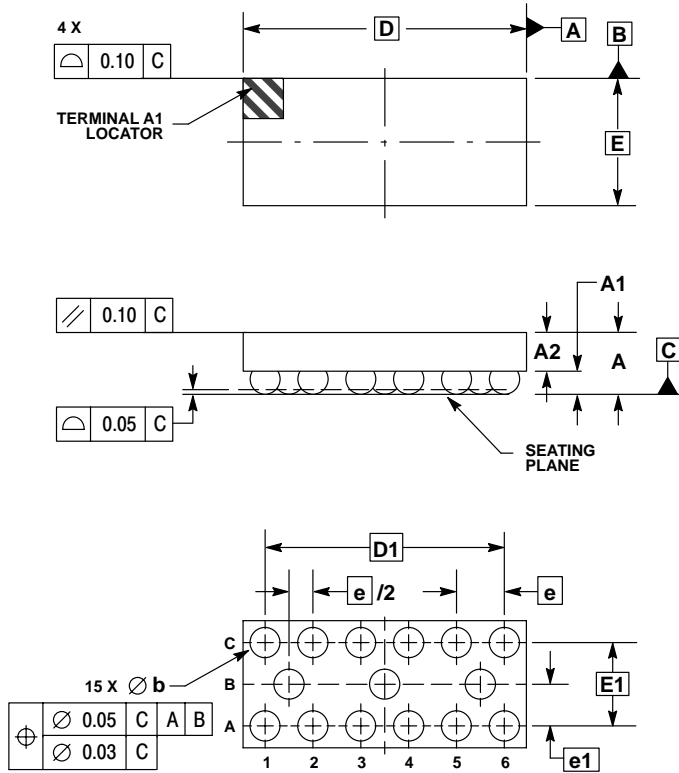

Figure 7. Solder Reflow Profile

# NUF4105FC

## PACKAGE DIMENSIONS

### 15 PIN FLIP-CHIP CSP CASE 499D-01 ISSUE O



#### NOTES:

1. DIMENSIONING AND TOLERANCING PER ASME Y14.5M, 1994.
2. CONTROLLING DIMENSION: MILLIMETER.
3. COPLANARITY APPLIES TO SPHERICAL CROWNS OF SOLDER BALLS.

DIM	MILLIMETERS	
	MIN	MAX
A	---	0.700
A1	0.210	0.270
A2	0.380	0.430
D	2.960 BSC	
E	1.330 BSC	
b	0.290	0.340
e	0.500 BSC	
e1	0.435 BSC	
D1	2.500 BSC	
E1	0.870 BSC	

# NUF4105FC

**ON Semiconductor** and  are registered trademarks of Semiconductor Components Industries, LLC (SCILLC). SCILLC reserves the right to make changes without further notice to any products herein. SCILLC makes no warranty, representation or guarantee regarding the suitability of its products for any particular purpose, nor does SCILLC assume any liability arising out of the application or use of any product or circuit, and specifically disclaims any and all liability, including without limitation special, consequential or incidental damages. "Typical" parameters which may be provided in SCILLC data sheets and/or specifications can and do vary in different applications and actual performance may vary over time. All operating parameters, including "Typicals" must be validated for each customer application by customer's technical experts. SCILLC does not convey any license under its patent rights nor the rights of others. SCILLC products are not designed, intended, or authorized for use as components in systems intended for surgical implant into the body, or other applications intended to support or sustain life, or for any other application in which the failure of the SCILLC product could create a situation where personal injury or death may occur. Should Buyer purchase or use SCILLC products for any such unintended or unauthorized application, Buyer shall indemnify and hold SCILLC and its officers, employees, subsidiaries, affiliates, and distributors harmless against all claims, costs, damages, and expenses, and reasonable attorney fees arising out of, directly or indirectly, any claim of personal injury or death associated with such unintended or unauthorized use, even if such claim alleges that SCILLC was negligent regarding the design or manufacture of the part. SCILLC is an Equal Opportunity/Affirmative Action Employer. This literature is subject to all applicable copyright laws and is not for resale in any manner.

## PUBLICATION ORDERING INFORMATION

### LITERATURE FULFILLMENT:

Literature Distribution Center for ON Semiconductor  
P.O. Box 61312, Phoenix, Arizona 85082-1312 USA  
**Phone:** 480-829-7710 or 800-344-3860 Toll Free USA/Canada  
**Fax:** 480-829-7709 or 800-344-3867 Toll Free USA/Canada  
**Email:** [orderlit@onsemi.com](mailto:orderlit@onsemi.com)

**N. American Technical Support:** 800-282-9855 Toll Free  
USA/Canada

**Japan:** ON Semiconductor, Japan Customer Focus Center  
2-9-1 Kamimeguro, Meguro-ku, Tokyo, Japan 153-0051  
**Phone:** 81-3-5773-3850

**ON Semiconductor Website:** <http://onsemi.com>

**Order Literature:** <http://www.onsemi.com/litorder>

For additional information, please contact your  
local Sales Representative.

**NUF4105FC/D**