

# Medium power transistor (–30V, –1.0A)

## 2SA2048K

### ●Features

- 1) High speed switching. ( $T_f$ : Typ.: 20ns at  $I_c = -1.0A$ )
- 2) Low saturation voltage, typically  
(Typ.: –150mV at  $I_c = -500mA$ ,  $I_B = -50mA$ )
- 3) Strong discharge power for inductive load and capacitance load.
- 4) Complements the 2SC5730K

### ●Applications

Small signal low frequency amplifier  
High speed switching

### ●Structure

PNP Silicon epitaxial planar transistor

### ●Packaging

#### specifications

Type	Package	Taping
	Code	T146
	Basic ordering unit (pieces)	3000
2SA2048K		○

### ●Absolute maximum ratings ( $T_a=25^\circ C$ )

Parameter	Symbol	Limits	Unit
Collector-base voltage	$V_{CBO}$	–30	V
Collector-emitter voltage	$V_{CEO}$	–30	V
Emitter-base voltage	$V_{EBO}$	–6	V
Collector current	$I_c$	–1.0	A
	$I_{CP}$	–2.0	A *1
Power dissipation	$P_C$	200	mW *2
Junction temperature	$T_j$	150	°C
Range of storage temperature	$T_{stg}$	–55~+150	°C

\*1  $P_w=10ms$

\*2 Each terminal mounted on a recommended land

### ●External dimensions (Units : mm)

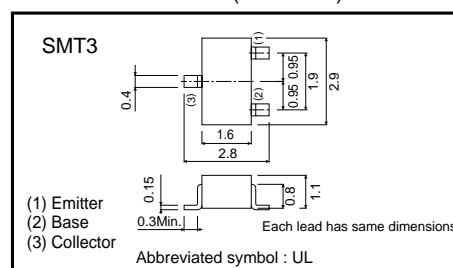

Transistor

●Electrical characteristics (Ta=25°C)

Parameter	Symbol	Min.	Typ.	Max.	Unit	Conditions
Collector-base breakdown voltage	BV <sub>CB0</sub>	-30	-	-	V	I <sub>C</sub> = -100μA
Collector-emitter breakdown voltage	BV <sub>CE0</sub>	-30	-	-	V	I <sub>C</sub> = -1mA
Emitter-base breakdown voltage	BV <sub>EB0</sub>	-6	-	-	V	I <sub>E</sub> = -100μA
Collector cut-off current	I <sub>CBO</sub>	-	-	-1.0	μA	V <sub>CB</sub> = -20V
Emitter cut-off current	I <sub>EBO</sub>	-	-	-1.0	μA	V <sub>EB</sub> = -4V
Collector-emitter saturation voltage	V <sub>CE(sat)</sub>	-	-150	-300	mV	I <sub>C</sub> = -500mA, I <sub>B</sub> = -50mA
DC current gain	h <sub>FE</sub>	120	-	390	-	V <sub>CE</sub> = -2V, I <sub>C</sub> = -100mA
Transition frequency	f <sub>r</sub>	-	350	-	MHz	V <sub>CE</sub> = -10V, I <sub>E</sub> =100mA, f=10MHz
Collector output capacitance	C <sub>ob</sub>	-	10	-	pF	V <sub>CB</sub> = -10V, I <sub>E</sub> =0mA, f=1MHz
Turn-on time	T <sub>on</sub>	-	30	-	ns	I <sub>C</sub> = -1.0A
Storage time	T <sub>stg</sub>	-	100	-	ns	I <sub>B1</sub> = -100mA
Fall time	T <sub>f</sub>	-	20	-	ns	I <sub>B2</sub> =100mA
						V <sub>CC</sub> = -25V

●h<sub>FE</sub> RANK

Q	R
120-270	180-390

●Electrical characteristic curves

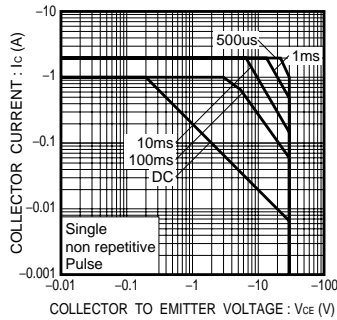

Fig.1 Safe Operating Area

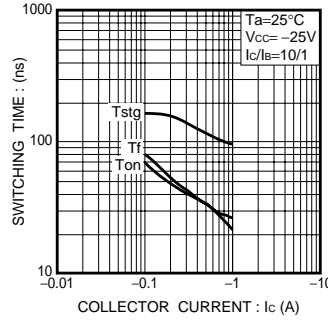

Fig.2 Switching Time

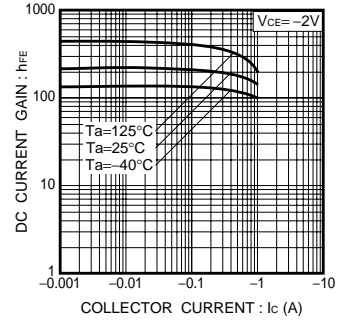

Fig.3 DC Current Gain vs. Collector Current (I)

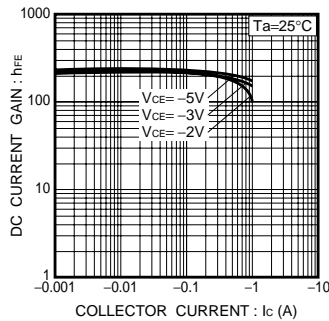

Fig.4 DC Current Gain vs. Collector Current (II)

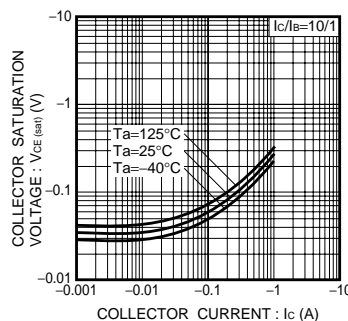

Fig.5 Collector-Emitter Saturation Voltage vs. Collector Current (I)

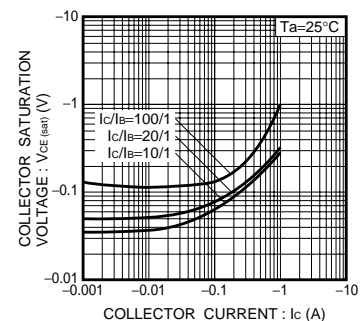

Fig.6 Collector-Emitter Saturation Voltage vs. Collector Current (II)

Transistor

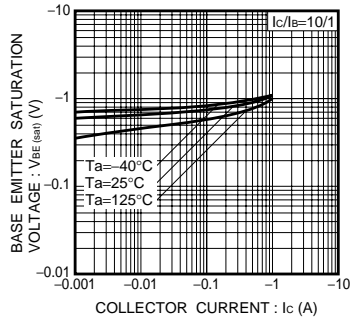

Fig.7 Base-Emitter Saturation Voltage vs. Collector Current

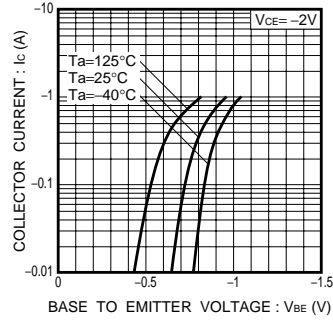

Fig.8 Grounded Emitter Propagation Characteristics

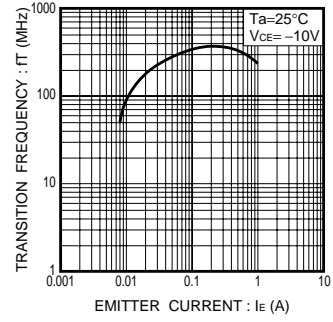

Fig.9 Transition Frequency

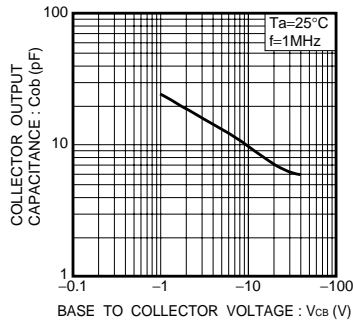
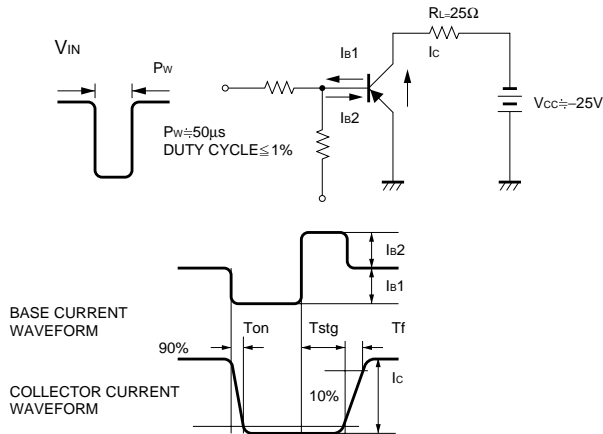

Fig.10 Collector Output Capacitance

●Switching characteristics measurement circuits



### Notes

- No technical content pages of this document may be reproduced in any form or transmitted by any means without prior permission of ROHM CO.,LTD.
- The contents described herein are subject to change without notice. The specifications for the product described in this document are for reference only. Upon actual use, therefore, please request that specifications to be separately delivered.
- Application circuit diagrams and circuit constants contained herein are shown as examples of standard use and operation. Please pay careful attention to the peripheral conditions when designing circuits and deciding upon circuit constants in the set.
- Any data, including, but not limited to application circuit diagrams information, described herein are intended only as illustrations of such devices and not as the specifications for such devices. ROHM CO.,LTD. disclaims any warranty that any use of such devices shall be free from infringement of any third party's intellectual property rights or other proprietary rights, and further, assumes no liability of whatsoever nature in the event of any such infringement, or arising from or connected with or related to the use of such devices.
- Upon the sale of any such devices, other than for buyer's right to use such devices itself, resell or otherwise dispose of the same, no express or implied right or license to practice or commercially exploit any intellectual property rights or other proprietary rights owned or controlled by ROHM CO., LTD. is granted to any such buyer.
- Products listed in this document use silicon as a basic material.  
Products listed in this document are no antiradiation design.

The products listed in this document are designed to be used with ordinary electronic equipment or devices (such as audio visual equipment, office-automation equipment, communications devices, electrical appliances and electronic toys).

Should you intend to use these products with equipment or devices which require an extremely high level of reliability and the malfunction of which would directly endanger human life (such as medical instruments, transportation equipment, aerospace machinery, nuclear-reactor controllers, fuel controllers and other safety devices), please be sure to consult with our sales representative in advance.

#### About Export Control Order in Japan

Products described herein are the objects of controlled goods in Annex 1 (Item 16) of Export Trade Control Order in Japan.

In case of export from Japan, please confirm if it applies to "objective" criteria or an "informed" (by MITI clause) on the basis of "catch all controls for Non-Proliferation of Weapons of Mass Destruction.