



2SC5353

NPN SILICON TRANSISTOR

HIGH VOLTAGE NPN TRANSISTOR

DESCRIPTION

Switching Regulator and High Voltage Switching Applications
High-Speed DC-DC Converter Applications

FEATURES

- * Excellent switching times: $t_R = 0.7\mu s_{(MAX)}$, $t_F = 0.5\mu s_{(MAX)}$
- * High collectors breakdown voltage: $V_{CEO} = 800V$

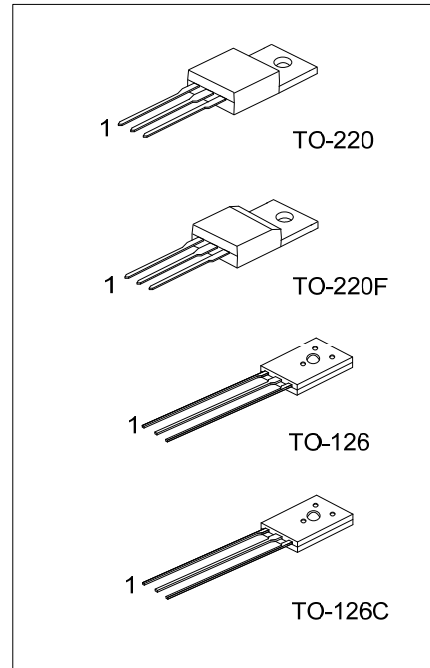

*Pb-free plating product number: 2SC5353L

ORDERING INFORMATION

Ordering Number		Package	Pin Assignment			Packing
Normal	Lead Free Plating		1	2	3	
2SC5353-T60-K	2SC5353L-T60-K	TO-126	B	C	E	Bulk
2SC5353-T6C-K	2SC5353L-T6C-K	TO-126C	B	C	E	Bulk
2SC5353-TA3-T	2SC5353L-TA3-T	TO-220	B	C	E	Tube
2SC5353-TF3-T	2SC5353L-TF3-T	TO-220F	B	C	E	Tube

<p>2SC5353L-TA3-T</p> <p>(1)Packing Type (2)Package Type (3)Lead Plating</p>	<p>(1) K: Bulk, T: Tube (2) T60: TO-126, T6C: TO-126C, TA3: TO-220, TF3: TO-220F (3) L: Lead Free Plating, Blank: Pb/Sn</p>
--	---

2SC5353

NPN SILICON TRANSISTOR

■ ABSOLUTE MAXIMUM RATINGS (T_c = 25°C)

PARAMETER		SYMBOL	RATINGS	UNIT
Collector-Base Voltage		V _{CBO}	900	V
Collector-Emitter Voltage		V _{CEO}	800	V
Emitter-Base Voltage		V _{EBO}	7	V
Collector Current	DC	I _C	3	A
	Pulse	I _{CP}	5	
Base Current		I _B	1	A
Collector Power Dissipation	TO-220F/ TO-126/TO-126C	P _D	20	W
	TO-220		25	
Junction Temperature		T _J	+150	°C
Storage Temperature		T _{STG}	-40 ~ +150	°C

Note Absolute maximum ratings are those values beyond which the device could be permanently damaged. Absolute maximum ratings are stress ratings only and functional device operation is not implied.

■ ELECTRICAL CHARACTERISTICS (T_c = 25°C)

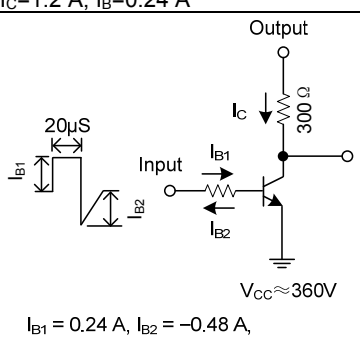
PARAMETER		SYMBOL	TEST CONDITIONS	MIN	TYP	MAX	UNIT
Collector-Base Breakdown Voltage		BV _{CBO}	I _C =1 mA, I _E = 0	900			V
Collector-Emitter Breakdown Voltage		BV _{CEO}	I _C =10 mA, I _B = 0	800			V
Collector Cut-off Current		I _{CBO}	V _{CB} =720V, I _E = 0			100	μA
Emitter Cut-off Current		I _{EBO}	V _{EB} =7V, I _C = 0			10	μA
DC Current Gain		h _{FE1}	V _{CE} =5 V, I _C =1 mA	10			
		h _{FE2}	V _{CE} =5 V, I _C =0.15 A	15			
Collector-Emitter Saturation Voltage		V _{CE(SAT)}	I _C =1.2 A, I _B =0.24 A			1.0	V
Base-Emitter Saturation Voltage		V _{BE(SAT)}	I _C =1.2 A, I _B =0.24 A			1.3	V
Switching Time	Rise Time	t _r				0.7	μS
	Storage Time	t _{STG}				4.0	
	Fall Time	t _f		I _{B1} = 0.24 A, I _{B2} = -0.48 A, duty cycle ≤ 1%			

TYPICAL CHARACTERISTICS

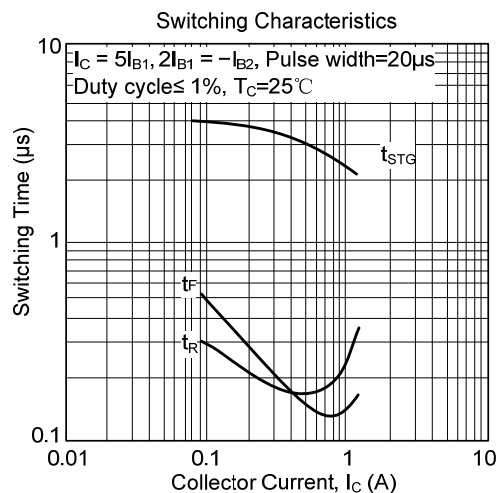
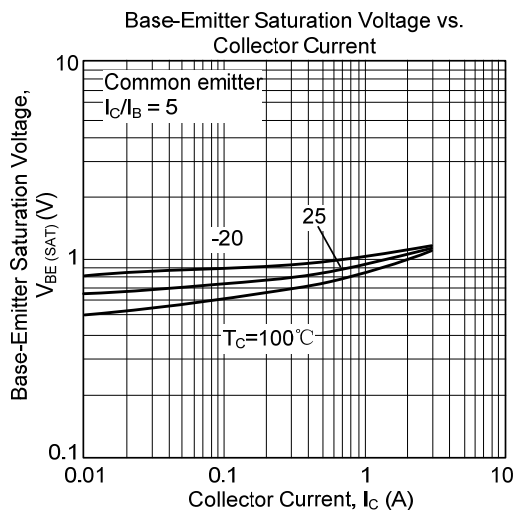
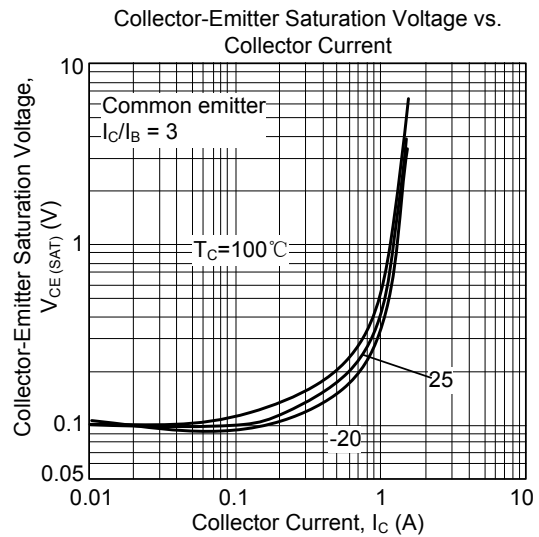
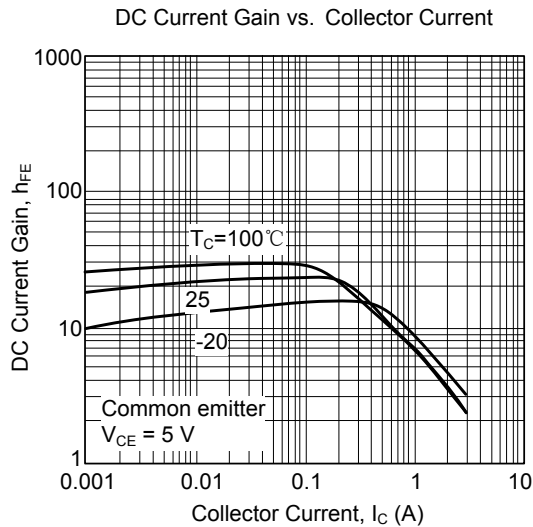
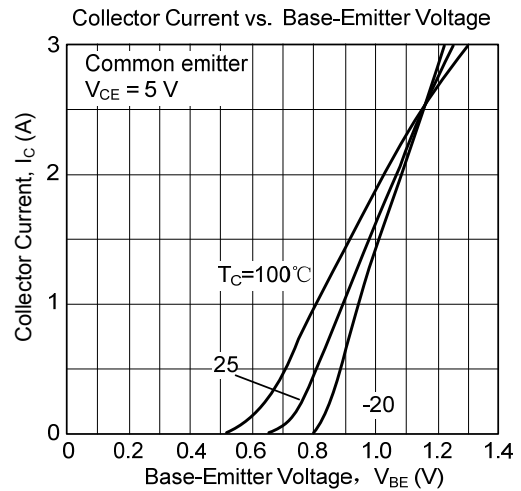
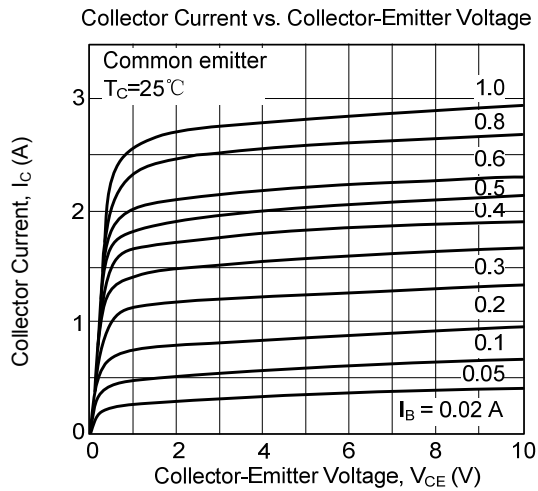

TYPICAL CHARACTERISTICS(Cont.)

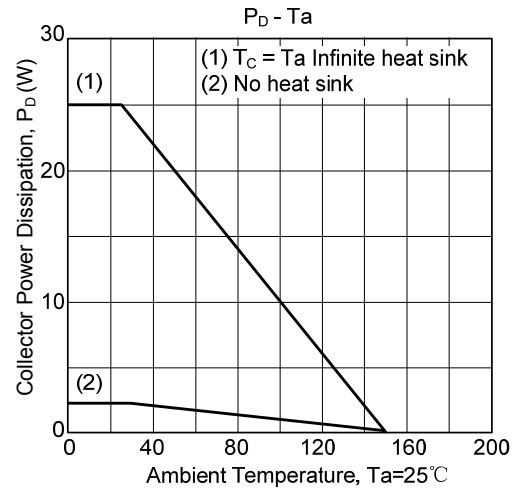
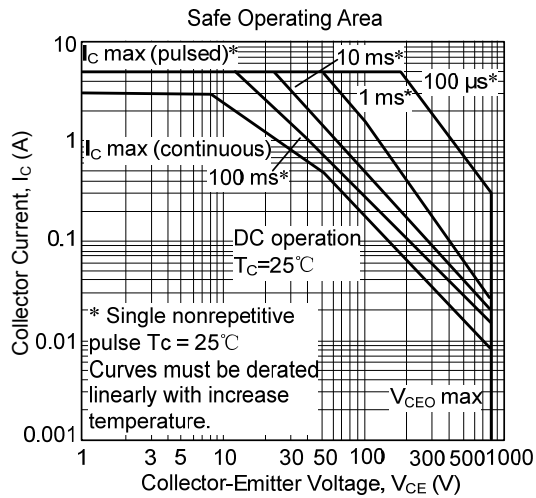

UTC assumes no responsibility for equipment failures that result from using products at values that exceed, even momentarily, rated values (such as maximum ratings, operating condition ranges, or other parameters) listed in products specifications of any and all UTC products described or contained herein. UTC products are not designed for use in life support appliances, devices or systems where malfunction of these products can be reasonably expected to result in personal injury. Reproduction in whole or in part is prohibited without the prior written consent of the copyright owner. The information presented in this document does not form part of any quotation or contract, is believed to be accurate and reliable and may be changed without notice.