

2SA1341, 2SC3395



2018A

T-37-13
T-35-11
PNP/NPN Epitaxial Planar
Silicon Transistors

Switching Applications (with Bias Resistances R1=47kΩ, R2=47kΩ)

©1283C

Applications

- Switching circuit, inverter circuit, interface circuit, driver circuit.

Features

- Built-in bias resistor (R1=47kΩ, R2=47kΩ).
- Small-sized package (CP).

(): 2SA1341

Absolute Maximum Ratings/T_a=25°C

			unit
Collector to Base Voltage	V _{CB0}	(-)50	V
Collector to Emitter Voltage	V _{CEO}	(-)50	V
Emitter to Base Voltage	V _{EB0}	(-)10	V
Collector Current	I _C	(-)100	mA
Peak Collector Current	I _{cp}	(-)200	mA
Collector Dissipation	P _C	200	mW
Junction Temperature	T _j	150	°C
Storage Temperature	T _{stg}	-55 to +150	°C

Electrical Characteristics/T_a=25°C

			min	typ	max	unit
Collector Cutoff Current	I _{CB0}	V _{CB} =(-)40V, I _E =0			(-)0.1	μA
Collector Cutoff Current	I _{CEO}	V _{CE} =(-)40V, I _B =0			(-)0.5	μA
Emitter Cutoff Current	I _{EB0}	V _{EB} =(-)5V, I _C =0	(-)30	(-)53	(-)80	μA
DC Current Gain	h _{FE}	V _{CE} =(-)5V, I _C =(-)5mA	50			
Gain Band-width product	f _T	V _{CE} (-)10V, I _C =(-)5mA		250 (200)		MHz
Output Capacitance	c _{ob}	V _{CB} =(-)10V, f=1MHz		3.5 (5.3)		pF
Collector to Emitter Saturation Voltage	V _{CE(sat)}	I _C =(-)5mA, I _B =(-)0.25mA		(-)0.1	(-)0.3	V

Continued on next page.

Marking

2SA1341:BL, 2SC3395:BY

Electrical Connection

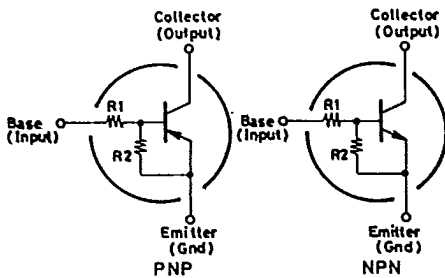

Case Outline 2018A (unit : mm)

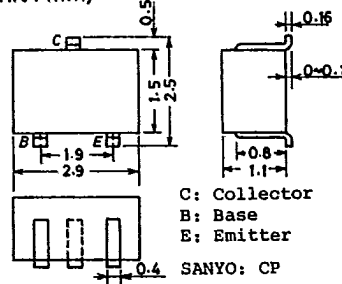

Continued from preceding page.

			min	typ	max	unit
Collector to Base Breakdown Voltage	$V_{(BR)CBO}$	$I_C=(-)10\mu A, I_E=0$	(-)50			V
Collector to Emitter Breakdown Voltage	$V_{(BR)CEO}$	$I_C=(-)100\mu A, R_{BE}=\infty$	(-)50			V
Input Off Voltage	$V_{I(off)}$	$V_{CE}=(-)5V, I_C=(-)100\mu A$	(-)0.8	(-)1.1	(-)1.5	V
Input On Voltage	$V_{I(on)}$	$V_{CE}=(-)0.2V, I_C=(-)5mA$	(-)1.0	(-)2.5	(-)5.0	V
Input Resistance	R_1		32	47	62	k Ω
Input Resistance Ratio	R_1/R_2		0.9	1.0	1.1	-

■ Sample Application Circuit

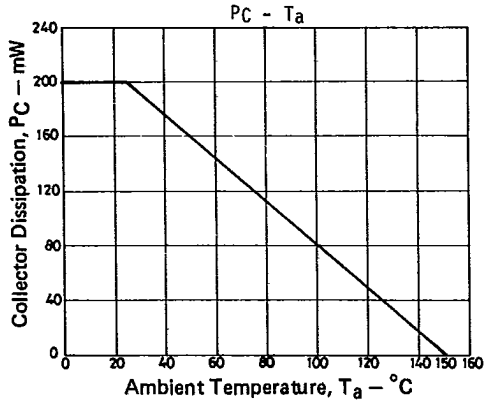
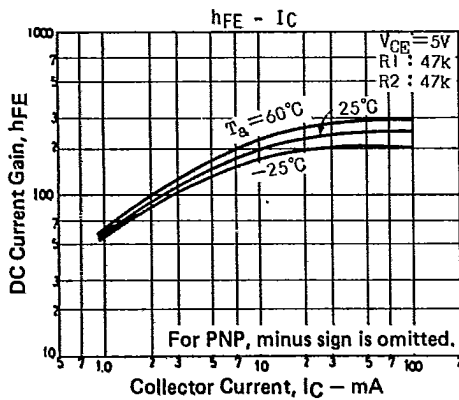
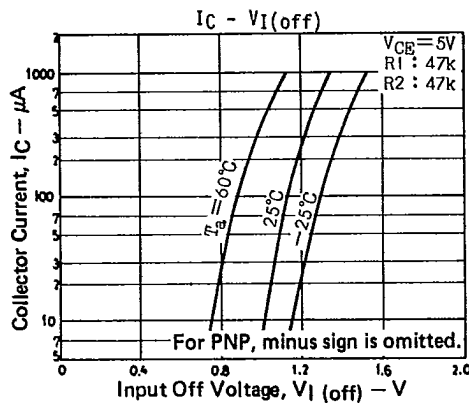
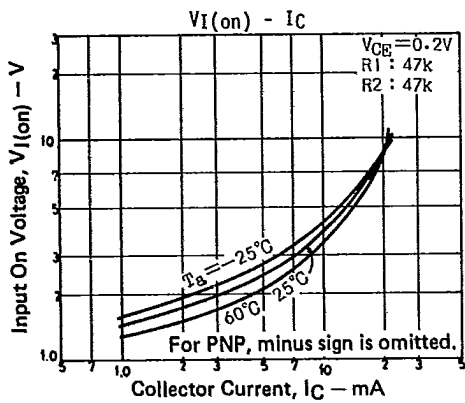
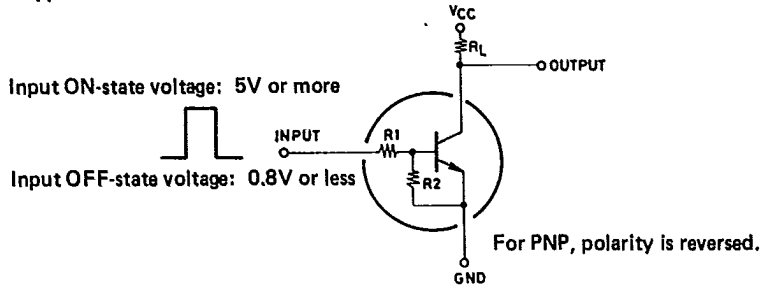

T-91-20

CASE OUTLINES OF SURFACE MOUNT TRANSISTORS

- All of Sanyo surface mount transistor case outlines are illustrated below.
- All dimensions are in mm, and dimensions which are not followed by min. or max. are represented by typical values.
- No marking is indicated.

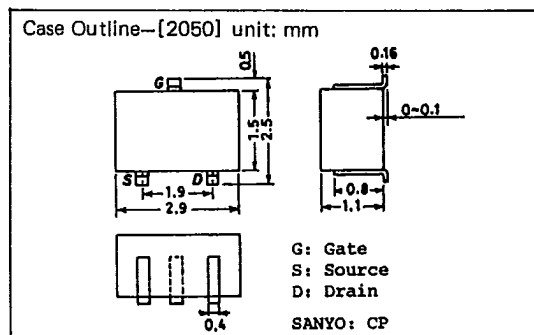
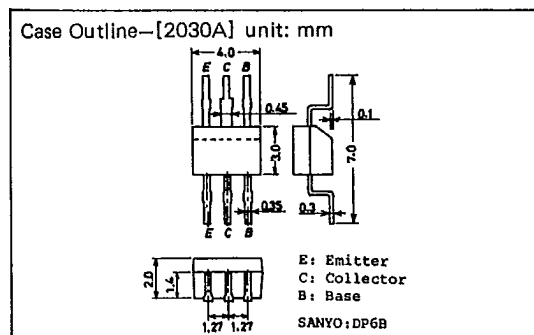
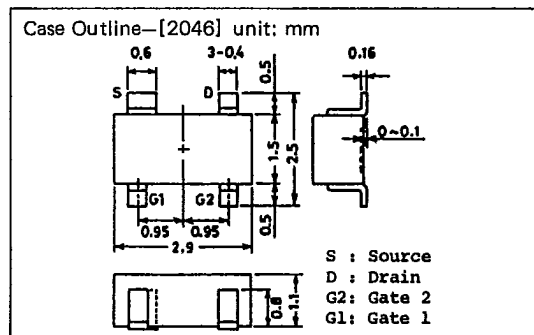
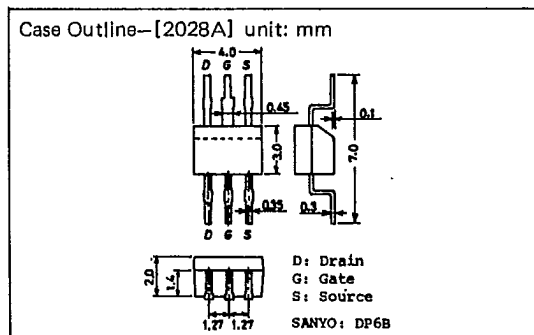
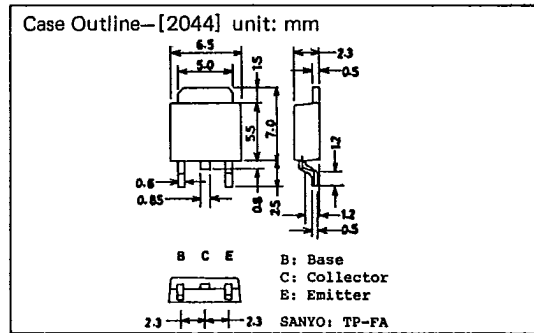
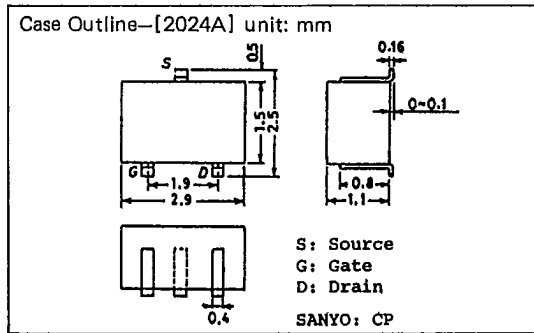
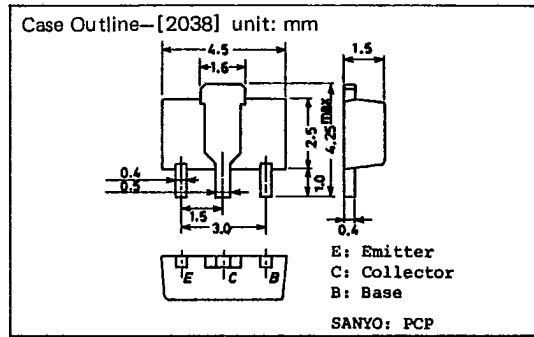
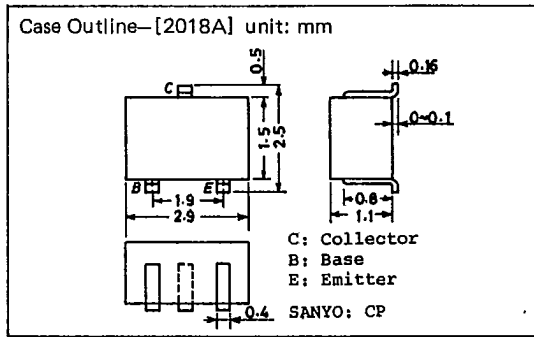

T-91-20

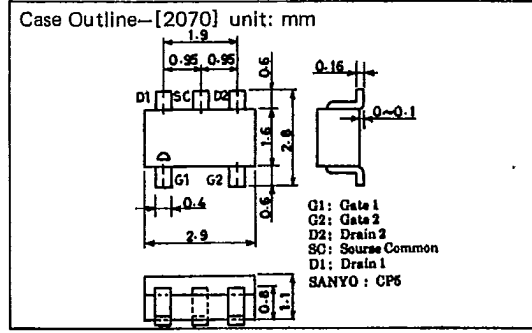
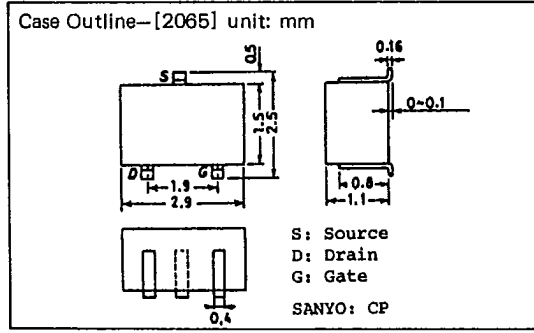
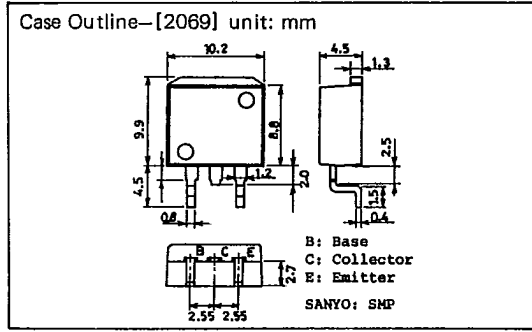
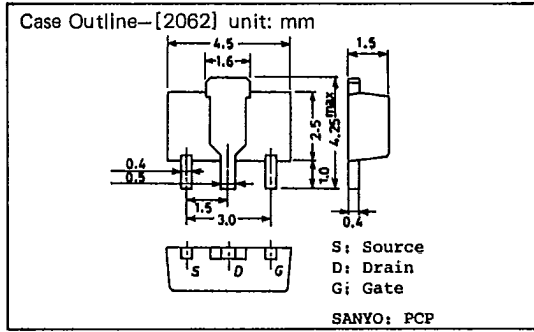
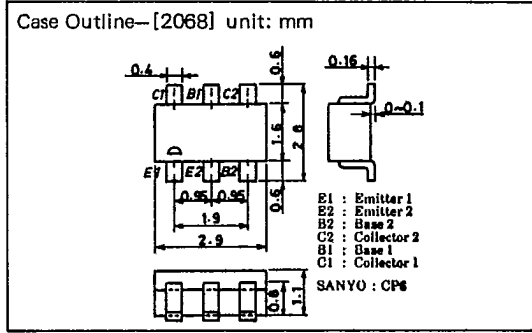
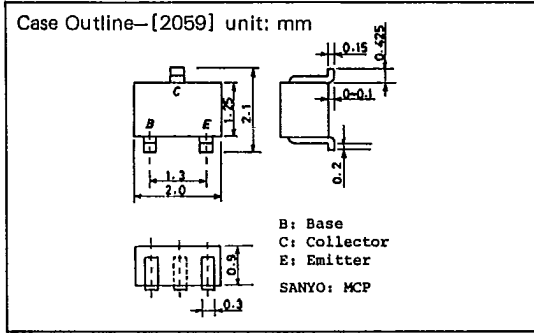
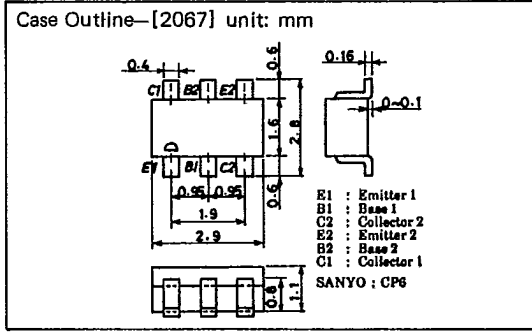
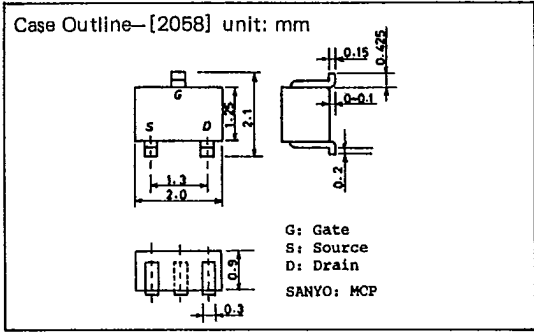
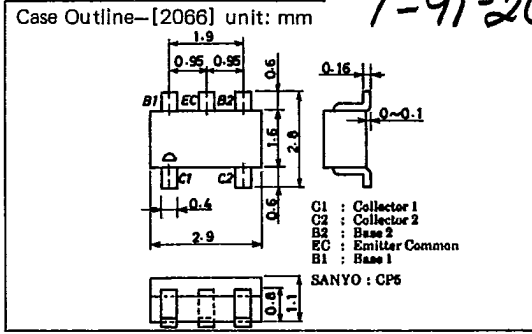
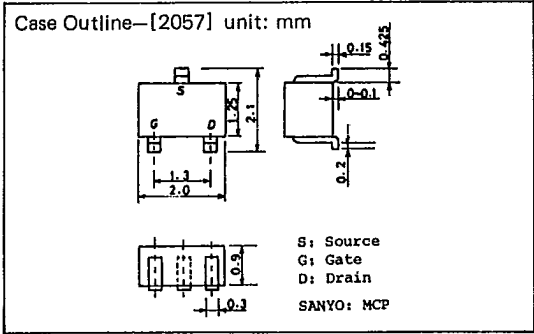

T-91-20

