

Features

- Output Current: 200mA or more
- Dropout Voltage: 150mV@200mA
- Operating Voltage Range: 1.8V-5.5V
- Output Voltage Range: 1.2V-4.5V(100 mV Step)
- High Accuracy: ±2.0%
- Low Power Consumption: 55 µA
- Standby Current: 0.1µA
- High Ripple Rejection: 70dB@ 1kHz
- Output Current-Limit Protection
- Short Circuit Protection
- Optional Auto Output Discharge
- Operating Temperature Range: -40 to +85
- Low ESR Capacitor Compatible: Ceramic Capacitor
- Thermal Shutdown Protection
- Package: SOT23-6L and TDFN-6L

Application

- Mobile phones (PDC, GSM, CDMA, IMT2000 etc.)
- Cordless phones and radio communication equipment
- Digital still cameras and video cameras
- PDAs
- MP3 players
- Portable devices

Description

The PT7M8402 series are highly accurate, dual, low dropout voltage regulators with low noise, high ripple rejection and low current consumption.

The PT7M8402 includes a reference voltage source, error amplifiers, driver transistors, individual enable inputs, current limit protections, short circuit protections, thermal shutdown protection and internal phase compensators.

The output voltage for each regulator is set by factory trimming within a range of 1.2V to 4.5V in 100mV step. The PT7M8402 series are stable with low ESR ceramic capacitors. The PT7M8402 series are available in the SOT23-6L and DFN-6L packages.

Ordering Information

Part Number		Package
PT7M8402	ZEE	Lead free and Green TDFN-6L
PT7M8402	TA6E	Lead free and Green SOT23-6L

Note: “ ” refer to different functions. See below Table 1.

Table 1 PT7M8402 Options

Designator	Symbol	Description	Designator	Symbol	Description
Regulators 1 and 2 EN type	AA	High active with pull-down resistor, with auto output discharge	Regulator 1 Output voltage	12-45	Internally set sequential number relating output voltage of regulator 1 Regulator 1 Output Voltage Range: 1.2~ 4.5V, the detail is in Table 2.
	BB	High active without pull-down resistor, with auto output discharge		2A	
	CC	Low active with pull-up resistor, with auto output discharge			
	DD	Low active without pull-up resistor, with auto output discharge			
	EE	High active with pull-down resistor, without auto output discharge	Regulator 2 Output voltage	12-45	Internally set sequential number relating output voltage of regulator 2 Regulator 2 Output Voltage Range: 1.2~ 4.5V, the detail is in Table 2.
	FF	High active without pull-down resistor, without auto output discharge		2A	
	GG	Low active with pull-up resistor, without auto output discharge			
	HH	Low active without pull-up resistor, without auto output discharge			

Table 2 Sequential Number Description

Designator	V _{OUT1} or V _{OUT2} (V)	Designator	V _{OUT1} or V _{OUT2} (V)	Designator	V _{OUT1} or V _{OUT2} (V)	Designator	V _{OUT1} or V _{OUT2} (V)
		21	2.1	31	3.1	41	4.1
12	1.2	22	2.2	32	3.2	42	4.2
13	1.3	23	2.3	33	3.3	43	4.3
14	1.4	24	2.4	34	3.4	44	4.4
15	1.5	25	2.5	35	3.5	45	4.5
16	1.6	26	2.6	36	3.6	2A	2.85
17	1.7	27	2.7	37	3.7		
18	1.8	28	2.8	38	3.8		
19	1.9	29	2.9	39	3.9		
20	2.0	30	3.0	40	4.0		

Pin Assignment

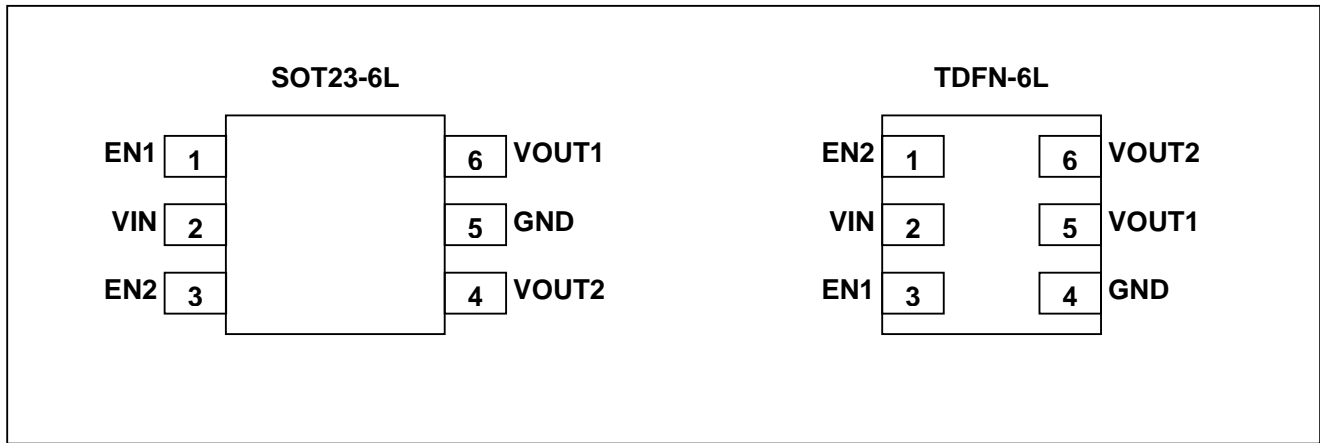

Pin Description

Pin No.		Pin Name	Description
SOT23-6L	TDFN-6L		
1	3	EN1	ON/OFF Control of Regulator 1.
2	2	VIN	Regulators Supply Input. Supply voltage can range from 1.8V to 5.5V. Bypass with a 1μF ceramic capacitor (X5R/X7R) to GND.
3	1	EN2	ON/OFF Control of Regulator 2.
4	6	VOUT2	Output of Regulator 2. Bypass with a 1μF ceramic capacitor (X5R/X7R) to GND.
5	4	GND	Ground.
6	5	VOUT1	Output of Regulator 1. Bypass with a 1μF ceramic capacitor (X5R/X7R) to GND.

Functional Description (Refer to Block Diagram)

Output Voltage

The divided output voltage is compared with the internal reference voltage by the error amplifier with internal phase compensator. The output of the error amplifier then drives the P-channel MOSFET to maintain a stable and constant output voltage.

Low ESR Capacitors

The internal phase compensator maintains the stable output voltage with low ESR ceramic input and output capacitors. 1µF low ESR (X5R/X7R) ceramic capacitors located as close as possible to the IC’s pins is recommended.

Current Limit , Short Circuit Protection and Thermal Shutdown Protection

Current limit protection is used to limit the output current when an overload condition occurs. As a result, the output voltage will drop. When the overload condition is getting worse and the output voltage is close to ground, the short circuit protection will further reduce the output current to a very low level to reduce the power dissipation in the IC. Thermal shutdown protection will turn off the output to reduce the power dissipation when the operation junction temperature exceeds 160°C.

EN Pins

The outputs of the two regulators can be controlled independently with the EN1 and EN2 pins. When a regulator is disabled, the output voltage is discharged by internal feedback resistor and the circuitry of the regulator will not consume power. In the IC with auto output discharge option, the output voltage is also discharged quickly by a pull-low transistor. For the IC with EN type of “without pull-up/down resistor”, the EN pin should be connected to a “VIN” or a “GND” voltage as a floating input applied to inverter input of the enable circuitry will increase the current consumption.

■ **NOTE ON USE**

1. Please use this IC within the stated absolute maximum ratings.
2. Where wiring impedance is high, operations may become unstable due to noise and/or phase lag depending on output current. Please keep the resistance low between VIN and GND wiring in particular.
3. Please wire the input capacitor (C_{IN}) and the output capacitors (C_{OUT1}, C_{OUT2}) as close to the IC as possible.

Maximum Ratings

Storage Temperature.....	- 55°C to +125°C
Ambient Temperature with Power Applied.....	-40°C to +85°C
Input Voltage	+6.0V
Output Voltage	- 0.3 to V _{CC} +0.3V
EN pin Voltage	+6.0V
DC Input/Output Current	700mA
Power Dissipation.....	250mW

Note:

Stresses greater than those listed under MAXIMUM RATINGS may cause permanent damage to the device. This is a stress rating only and functional operation of the device at these or any other conditions above those indicated in the operational sections of this specification is not implied. Exposure to absolute maximum rating conditions for extended periods may affect reliability.

Electrical Characteristics

Regulator 1, Regulator 2 $T_A=25$

PARAMETER	SYMBOL	CONDITIONS	MIN	TYP	MAX	UNIT	
Output Voltage	$V_{OUT(E)}$	$V_{IN}=V_{OUT(T)}+1.0V$ $I_{OUT}=30mA$	$V_{OUT(T)}^*$ 0.98	$V_{OUT(T)}$	$V_{OUT(T)}$ *1.02	V	
Maximum Output Current	I_{OUTMAX}	$V_{IN}=V_{OUT(T)}+1.0V$	200	-	-	mA	
Load Regulation	ΔV_{OUT}	$1mA \leq I_{OUT} \leq 200mA$	-	30	60	mV	
Dropout Voltage	Vdif1	$I_{OUT}=30mA$	$1.7V \leq V_{OUT(T)} \leq 1.8V$	-	0.05	0.10	V
			$1.9V \leq V_{OUT(T)} \leq 2.7V$	-	0.03	0.06	
			$2.8V \leq V_{OUT(T)} \leq 4.5V$	-	0.02	0.04	
	Vdif2	$I_{OUT}=200mA$	$1.7V \leq V_{OUT(T)} \leq 1.8V$	-	0.30	0.60	V
			$1.9V \leq V_{OUT(T)} \leq 2.7V$	-	0.19	0.38	
			$2.8V \leq V_{OUT(T)} \leq 4.5V$	-	0.15	0.30	
Supply Current	I_{SS}	$V_{IN}=V_{OUT(T)}+1.0V$ $I_{OUT}=0mA$	-	55	85	μA	
Standby Current	I_{STB}	$V_{IN}=V_{OUT(T)}+1.0V$ $V_{EN}=0V$	-	0.1	1	μA	
Line Regulation	$\frac{\Delta V_{OUT}}{\Delta V_{IN}} * V_{OUT}$	$V_{OUT(T)}+1.0V \leq V_{IN} \leq 6.0V$ $V_{EN}=V_{IN}, I_{OUT}=30mA$	-	0.05	0.20	%/V	
Input Voltage	V_{IN}		1.8	-	5.5	V	
Output Voltage Temperature Characteristic	$\frac{\Delta V_{OUT}}{\Delta T_{opr}} * V_{OUT}$	$I_{OUT}=30mA$ $-40 \leq T_{opr} \leq 85$	-	± 100	-	ppm/	
Ripple Rejection	PSRR	$V_{IN}=[V_{OUT(T)}+1.0]V_{DC}+1V_{p-p} AC$ $I_{OUT}=30mA, f=1kHz$	-	70	-	dB	
Current Limit	I_{lim}	$V_{IN}=V_{OUT(T)}+1.0V$ $V_{EN}=V_{IN}$	-	300	-	mA	
Short-Circuit Current	I_{short}	$V_{IN}=V_{OUT(T)}+1.0V$ $V_{EN}=V_{IN}$	-	50	-	mA	
Thermal shutdown	TSD		-	160	-		
Thermal Shutdown Hysteresis	TSD		-	20	-		
EN"High"Voltage	V_{ENH}		1.5	-	-	V	
EN"Low"Voltage	V_{ENL}		-	-	0.3	V	
EN"High"Current	I_{ENH}	$V_{IN}=V_{OUT(T)}+1.0V$	-0.10	-	0.10	μA	
EN"Low" Current	I_{ENL}	$V_{IN}=V_{OUT(T)}+1.0V$ $V_{EN}=0V$	-0.10	-	0.10	μA	
Pull-Down or Push-Up Resistance for EN Pin	R_{PD}		0.5	1.0	2.0	$M\Omega$	
Low Output Nch Tr. ON Resistance	R_{LOW}	$V_{IN}=V_{OUT(T)}+1.0V$ $V_{EN}=0V$	-	500	-	Ω	

Note:

*1 : $V_{OUT(T)}$ =Specified output voltage

*2 : $V_{OUT(E)}$ =Effective output voltage

(I.e. the output voltage when " $V_{OUT(T)} + 1.0V$ " is provided at the V_{IN} pin while maintaining a certain I_{OUT} value).

*3 : $V_{dif} = \{V_{IN1}^{(95)} - V_{OUT1}^{(95)}\}$

*4 : V_{OUT1} =A voltage equal to 98% of the output voltage whenever an amply stabilized I_{OUT} $\{V_{OUT(T)}+1.0V\}$ is input.

*5 : V_{IN1} =The input voltage when V_{OUT1} appears as input voltage is gradually decreased.

*6 : Unless otherwise stated, $V_{IN}=V_{OUT(T)}+1.0V$

Block Diagram

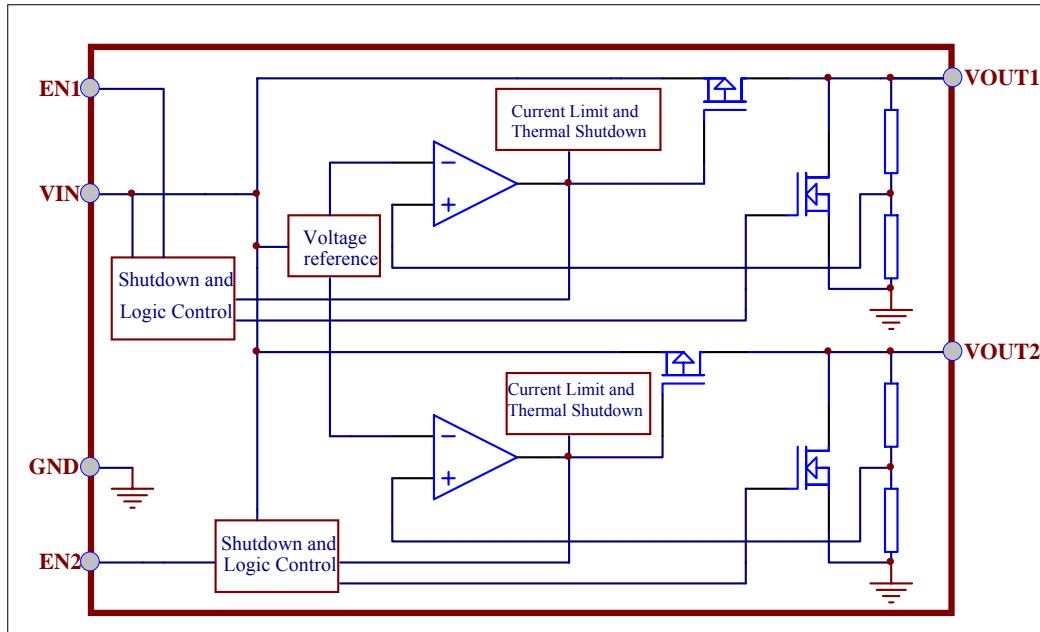

Application Circuit

Application circuit for SOT-23-6L

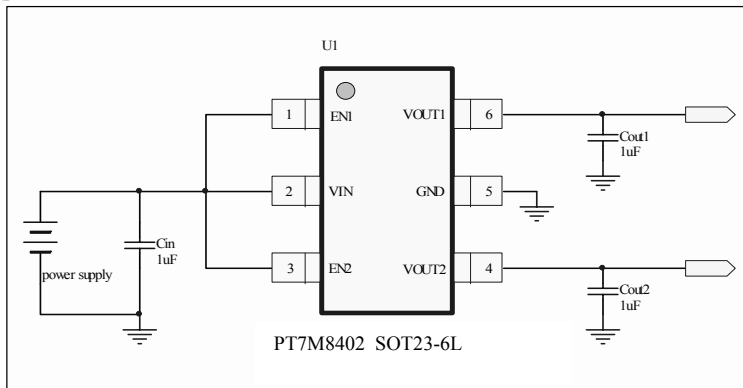

Application circuit for TDFN-6L

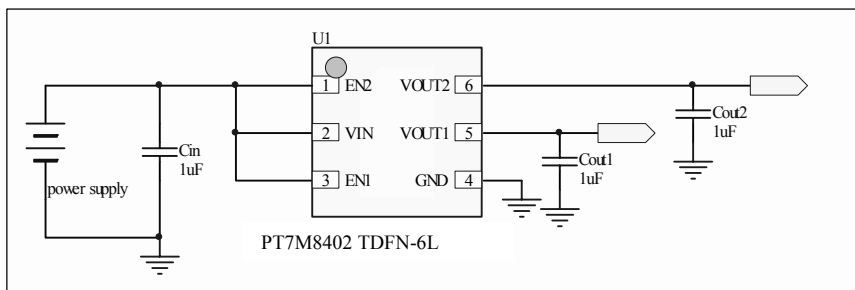

Typical Performance Characteristics

1. Output Voltage vs. Output Current

PT7M8402 (1.8V)

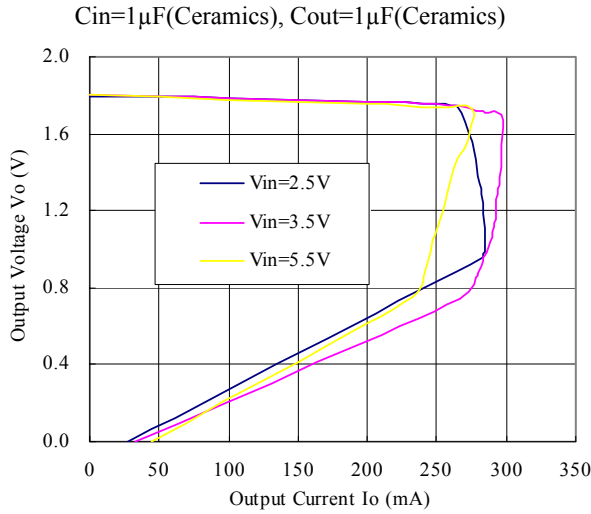

PT7M8402 (2.8V)

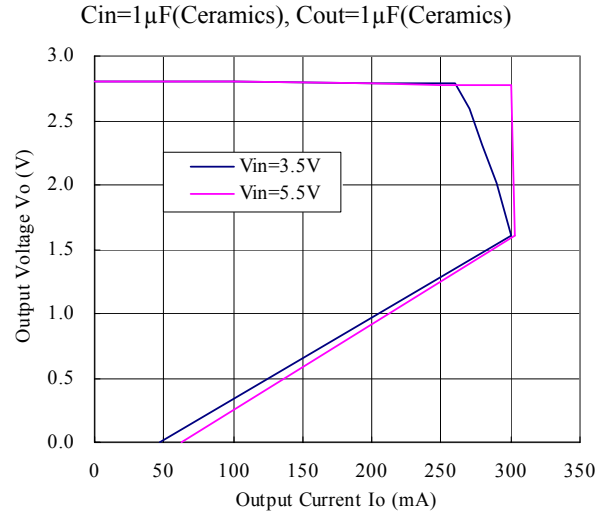

2. Output Voltage vs. Input Voltage

PT7M8402 (1.8V)

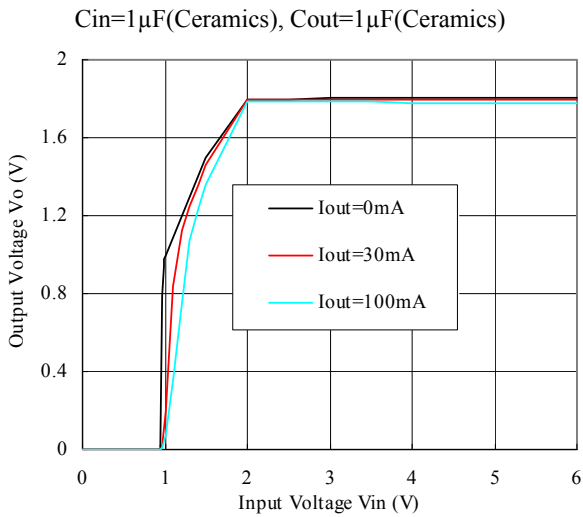

PT7M8402 (2.8V)

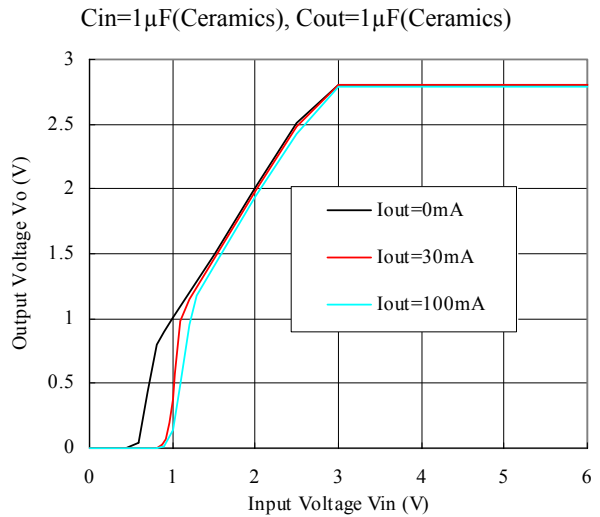

3. Dropout Voltage vs. Output Current

PT7M8402 (1.8V)

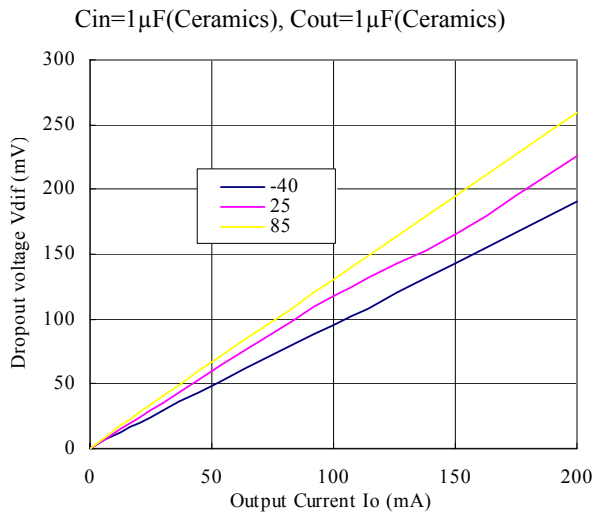

PT7M8402 (2.8V)

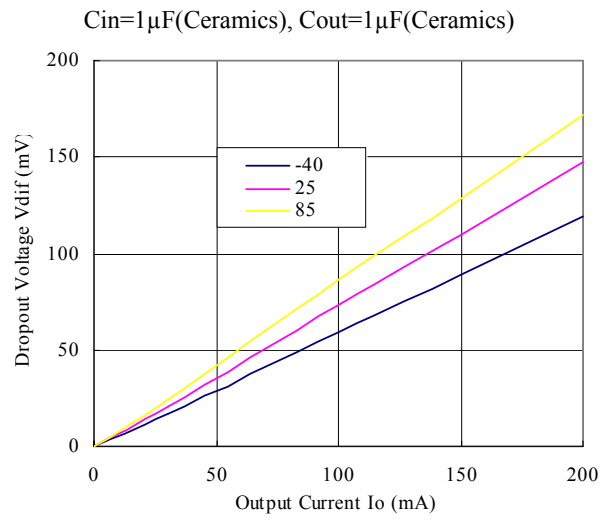

4. Supply Current vs. Input Voltage

PT7M8402 (1.8V)

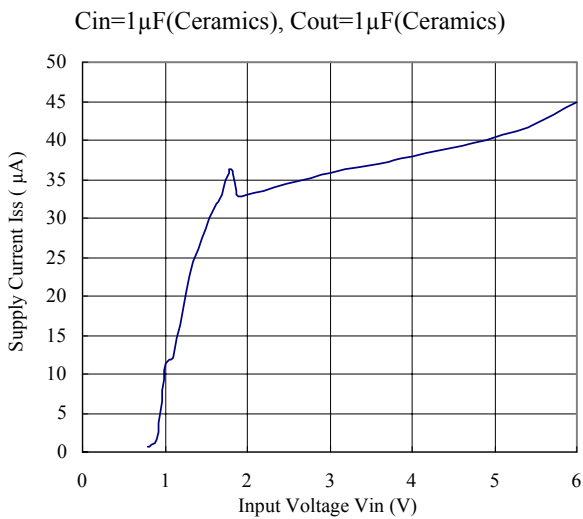

PT7M8402 (2.8V)

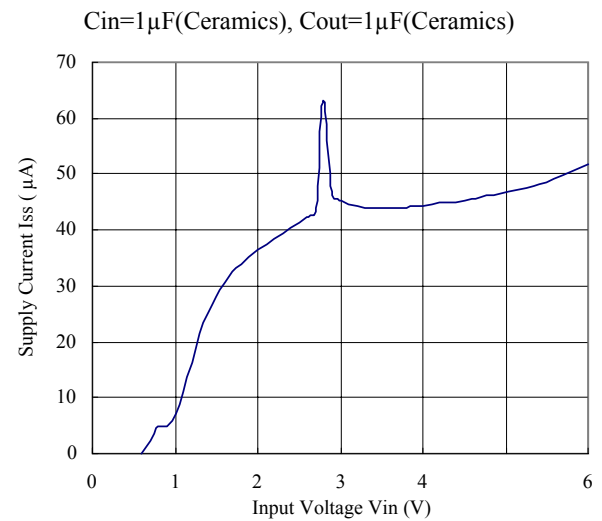

5. Output Voltage vs. Ambient Temperature

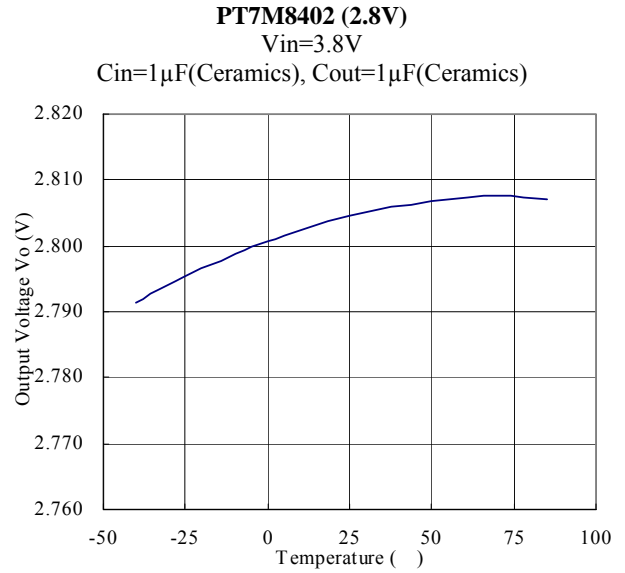
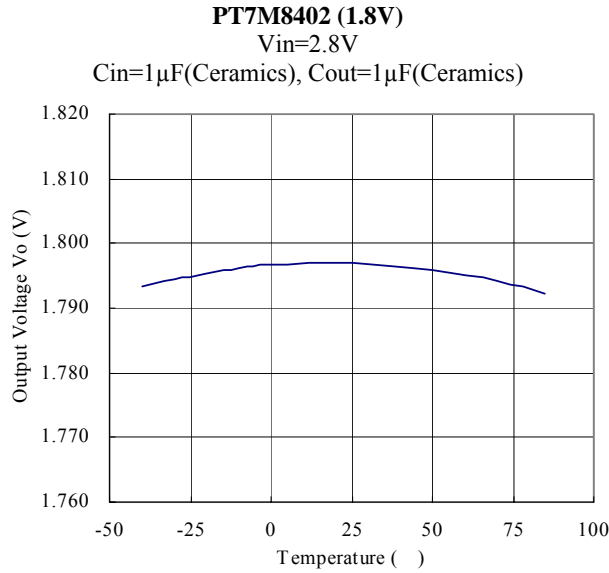

6. Supply Current vs. Ambient Temperature

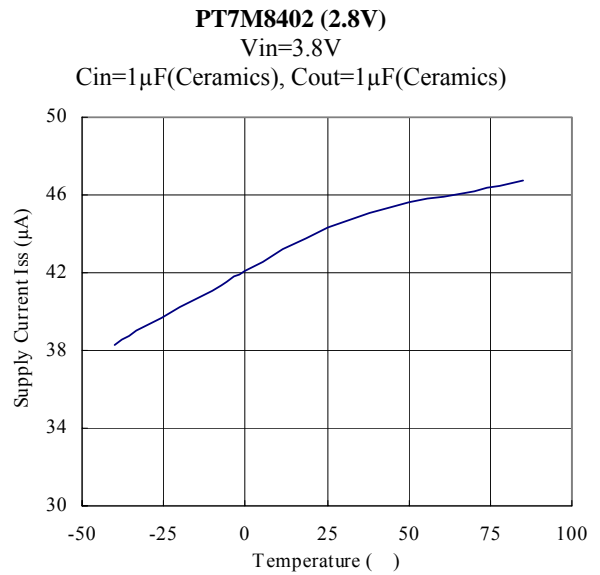
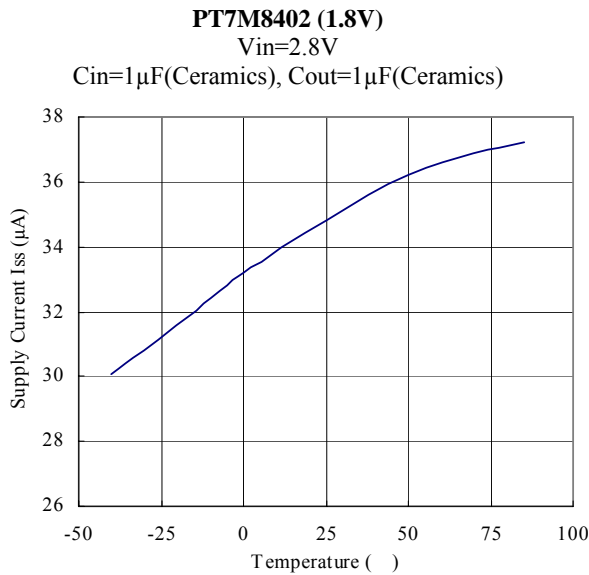

7. Load Transient Response and Cross Talk

PT7M8402 (1.8V)

Vout1=1.8V, Vout2=2.8V, 100µs/div
 Cin= Cout=1µF(Ceramics), Vin=3.3V, tr=tf=1µs

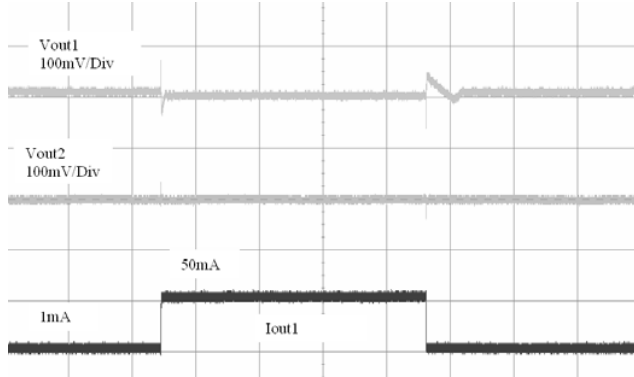

PT7M8402 (2.8V)

Vout1=1.8V, Vout2=2.8V, 100µs/div
 Cin= Cout=1µF(Ceramics), Vin=3.3V, tr=tf=1µs

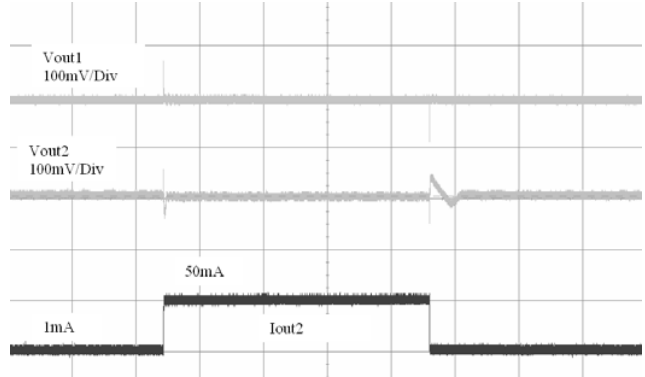

PT7M8402 (1.8V)

Vout1=1.8V, Vout2=2.8V, 100µs/div
 Cin= Cout=1µF(Ceramics), Vin=3.3V, tr=tf=1µs

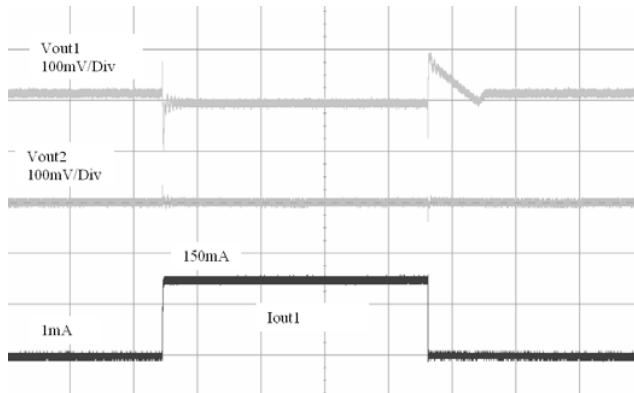

PT7M8402 (2.8V)

Vout1=1.8V, Vout2=2.8V, 100µs/div
 Cin= Cout=1µF(Ceramics), Vin=3.3V, tr=tf=1µs

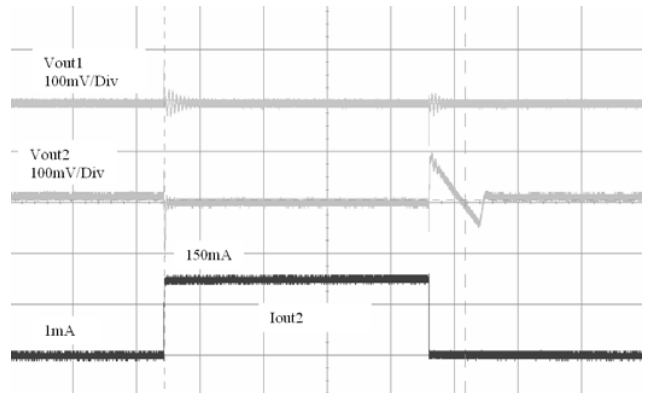

8. Input Transient Response

PT7M8402 (1.8V)

50 μ s/div

Cout=1 μ F(Ceramics), Iout=30mA, tr=tf=5 μ s

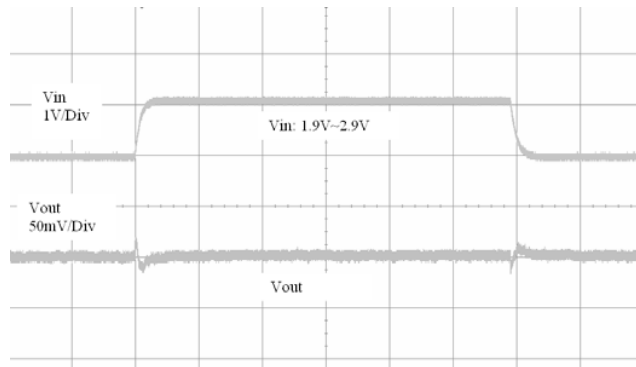

PT7M8402 (2.8V)

50 μ s/div

Cin= Cout=1 μ F(Ceramics), Iout=30mA, tr=tf=5 μ s

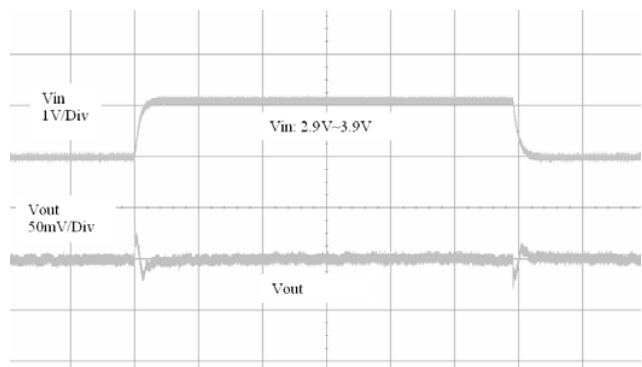

9. Ripple Rejection

PT7M8402 (2.8V)

Vin=3.8V DC+1Vp-pAC

Cin= Cout=1 μ F (Ceramics), Iout=30mA

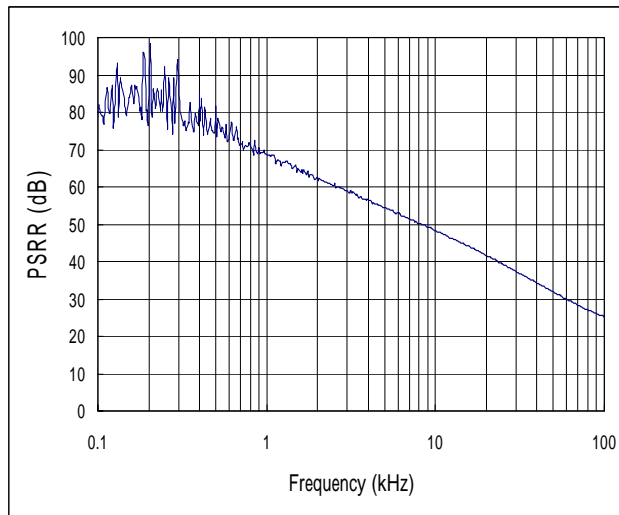

Mechanical Information

TA6E (Lead free and Green SOT23-6L)

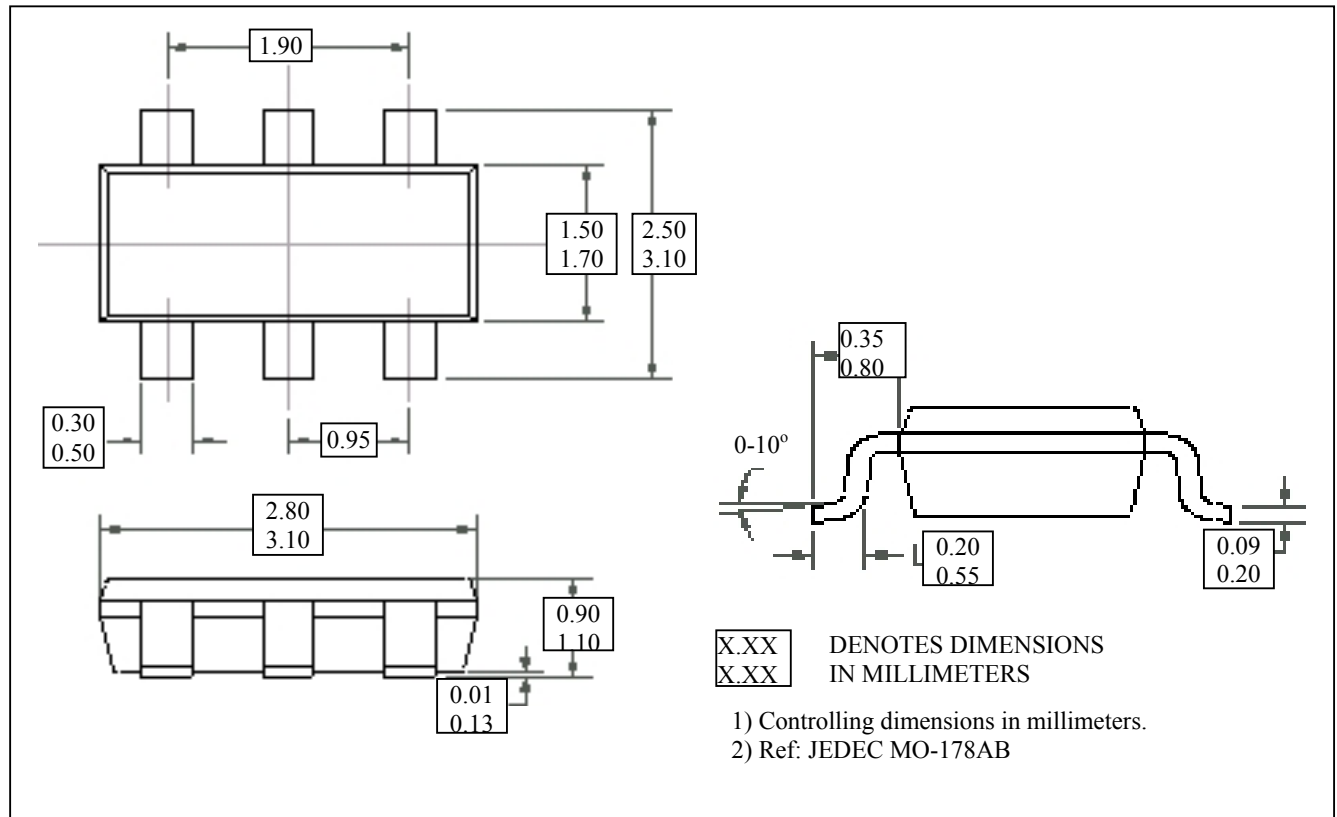

ZEE (Lead free and Green TDFN-6L)

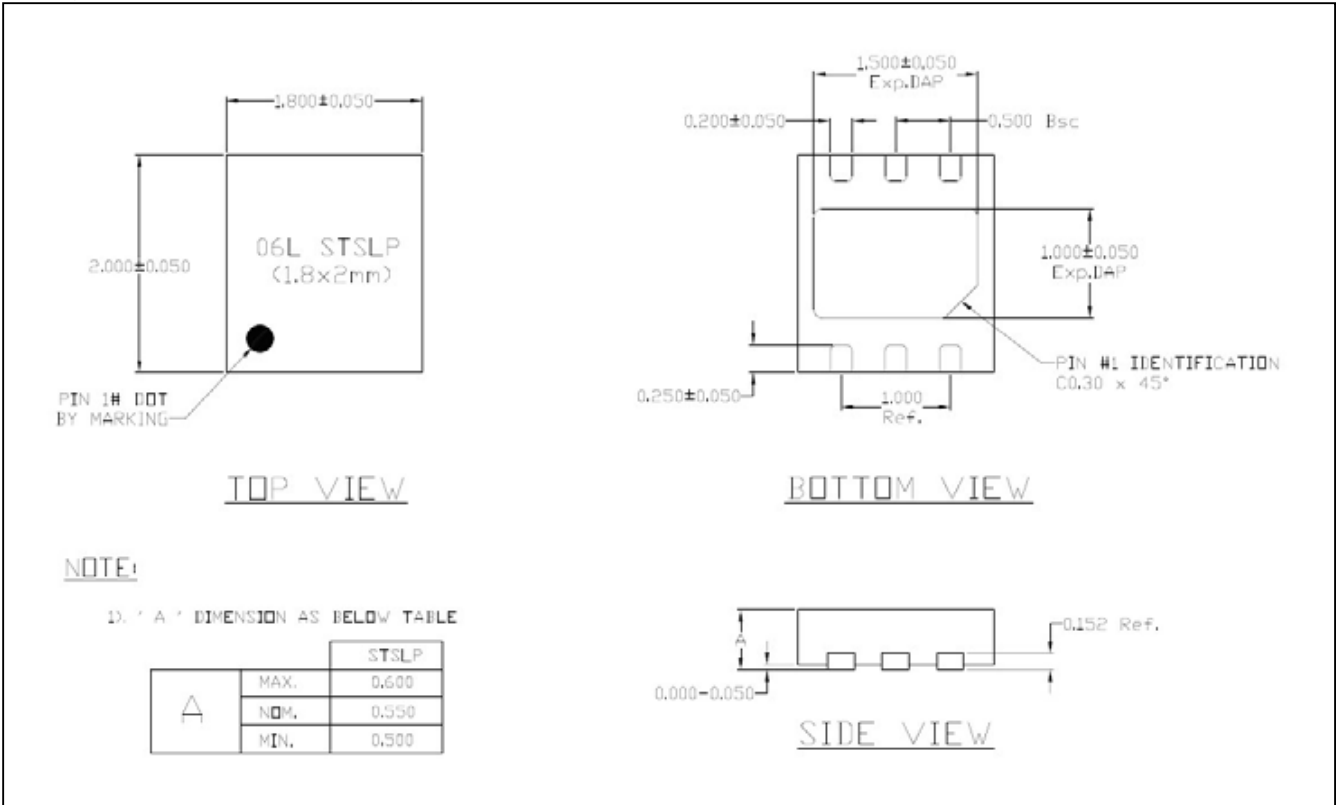

Notes

Pericom Technology Inc.

Email: support@pti.com.cn Web Site: www.pti.com.cn, www.pti-ic.com

China: No. 20 Building, 3/F, 481 Guiping Road, Shanghai, 200233, China
Tel: (86)-21-6485 0576 Fax: (86)-21-6485 2181

Asia Pacific: Unit 1203, 12/F, Chevalier Commercial Centre, 8 Wang Hoi Rd, Kowloon Bay, Hongkong
Tel: (852)-2243 3660 Fax: (852)- 2243 3667

U.S.A.: 3545 North First Street, San Jose, California 95134, USA
Tel: (1)-408-435 0800 Fax: (1)-408-435 1100

Pericom Technology Incorporation reserves the right to make changes to its products or specifications at any time, without notice, in order to improve design or performance and to supply the best possible product. Pericom Technology does not assume any responsibility for use of any circuitry described other than the circuitry embodied in Pericom Technology product. The company makes no representations that circuitry described herein is free from patent infringement or other rights, of Pericom Technology Incorporation.