

Ultra-low Quiescent Current, High Efficiency Boost Regulator

FEATURES

- Ultra-low 12 μ A Quiescent Current
- 400mA Output Current at 2.6V Input: 3.3V_{OUT}
- 94% Efficiency from 2 Cell to 3.3V_{OUT}
- Wide Input Operating Voltage: 0.85V to 4.5V
- 3.3V Fixed or Adjustable Output
- Integrated Synchronous Rectifier: 0.3 Ω
- 0.3 Ω Switch
- Anti-Ringing Switch Technology
- Programmable Inductor Peak Current
- Logic Shutdown Control
- Under Voltage Lock-Out at 0.61V
- Programmable Low-Battery Detect
- Single or Dual Cell Alkaline
- Small 10 pin DFN Package and Industry Standard 10 pin MSOP

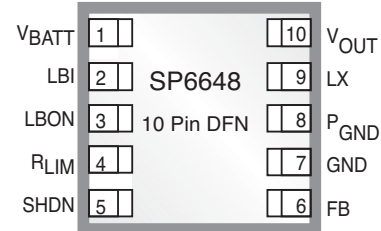

Now Available in Lead Free Packaging

APPLICATIONS

- Camera Flash LED Driver
- Wireless Mouse
- PDA's
- Pagers
- Medical Monitors
- Handheld Portable Devices
- MP3 Players

DESCRIPTION

The SP6648 is an ultra-low quiescent current, high efficiency step-up DC-DC converter ideal for single cell, dual cell alkaline and Li-Ion battery applications such as digital still cameras, PDAs, MP3 players, and other portable devices. The SP6648 combines the high-load efficiency associated with PWM control, with the low quiescent current and excellent light-load efficiency of PFM control. The SP6648 features 12 μ A quiescent current, synchronous rectification, a 0.3 Ω charging switch, anti-ringing inductor switch, programmable low-battery detect, under-voltage lockout and programmable inductor peak current. The device can be controlled by a 1nA active LOW shutdown pin.

TYPICAL APPLICATION CIRCUIT

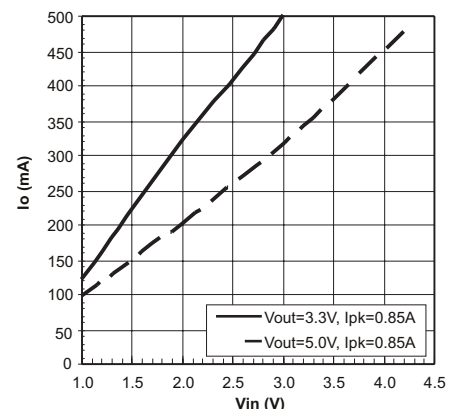
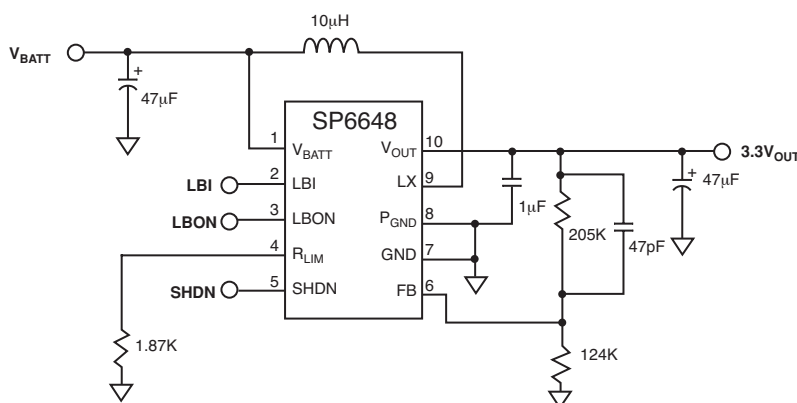

Maximum Load Current in Operation

ABSOLUTE MAXIMUM RATINGS

LX, V_O, V_{BATT}, LBON, FB to GND pin -0.3 to 6.0V
 SHDN, LBI -0.3V to V_{BATT}+1.0V
 V_O, GND, LX Current 2A
 Reverse V_{BATT} Current 220mA
 Forward V_{BATT} Current 500mA
 Storage Temperature -65 °C to 150 °C

Operating Temperature -40°C to +85°C
 ESD Rating 1.5kV HBM

These are stress ratings only and functional operation of the device at these ratings or any other above those indicated in the operation sections of the specifications below is not implied. Exposure to absolute maximum rating conditions for extended periods of time may affect reliability.

ELECTRICAL SPECIFICATIONS

V_{BATT}=V_{SHDN} = 2.6V, V_{FB}=0.0V, I_{LOAD} = 0mA, T_{AMB} = -40°C to +85°C, V_{OUT} = +3.3V, typical values at 27°C unless otherwise noted. The ♦ denotes the specifications which apply over full operating temperature range -40°C to +85°C, unless otherwise specified.

PARAMETER	MIN	TYP	MAX	UNITS	♦	CONDITIONS
Input Voltage Operating Range, V _{BATT}	0.7		4.5	V	♦	After Startup
Output Voltage Range, V _{OUT}	2.5		5.5	V	♦	
Start-up Input Voltage, V _{BATT}		0.85	1.1	V	♦	R _{LOAD} = 3kΩ
Under Voltage Lock-out/UVLO	0.5	0.61	0.7	V	♦	
Output Voltage, V _O	3.12	3.30	3.48	V	♦	Internal Feedback Divider
Quiescent Current into V _O , I _{QO}		12	25	μA	♦	V _{OUT} = 3.3V, V _{FB} = 1.5V, Toggle SHDN
Quiescent Current into V _{BATT} , I _{QB}		250	750	nA	♦	V _{OUT} = 3.3V, V _{FB} = 1.5V
Shutdown Current into V _O , I _{SDO}		1	500	nA	♦	V _{SHDN} = 0.0V
Shutdown Current into V _{BATT} , I _{SDB}		250	750	nA	♦	V _{SHDN} = 0.0V, V _{BATT} = 2.6V
Efficiency		84 92		% %		V _{BATT} = 1.3V, I _{OUT} = 100mA, R _{LIM} = 2kΩ V _{BATT} = 2.6V, I _{OUT} = 200mA, R _{LIM} = 2kΩ
Inductor Current Limit, I _{PK} = 1600/R _{LIM}	650	800	1000	mA	♦	R _{LIM} = 2kΩ
	1300	1600	2000	mA	♦	R _{LIM} = 1kΩ
Output Current		100 200		mA mA		V _{BATT} = 1.3V, R _{LIM} = 4kΩ V _{BATT} = 2.6V, R _{LIM} = 4kΩ
		150 400		mA mA		V _{BATT} = 1.3V, R _{LIM} = 2kΩ V _{BATT} = 2.6V, R _{LIM} = 2kΩ
Minimum Off-Time Constant K _{OFF}	0.5	1.0	1.5	V*μs	♦	K _{OFF} ≤ T _{OFF} (V _{OUT} - V _{BATT})
Maximum On-Time Constant K _{ON}	2.5	4.0	5.5	V*μs	♦	K _{ON} ≥ T _{ON} (V _{BATT})
Enable Valid to Output Stable		300	500	μs		I _{LOAD} = 1mA
NMOS Switch Resistance		0.30	0.6	Ω	♦	I _{NMOS} = 100mA
PMOS Switch Resistance		0.30	0.6	Ω	♦	I _{PMOS} = 100mA
FB Set Voltage, V _{FB}	1.19	1.25	1.31	V	♦	External feedback
FB Input Current		1	100	nA	♦	V _{FB} = 1.3V
LBI Falling Trip Voltage	0.56	0.61	0.66	V	♦	
LBI Hysteresis		25		mV		
Low Output Voltage for LBON, V _{OL}			0.4	V	♦	V _{BATT} = 1.3V, I _{SINK} = 1mA
Leakage current for LBON			1	μA	♦	V _{BATT} = 1.3V, V _{LBON} = 3.3V
SHDN Input Voltage, Note 1	V _{IL}		0.25		♦	V _{BATT} = 1.3V
	V _{IH}	1.0		V	♦	V _{BATT} = 1.3V
	V _{IL}		0.5		♦	V _{BATT} = 2.6V
	V _{IH}	2.0			♦	V _{BATT} = 2.6V
SHDN Input Current		1	100	nA	♦	
LX Pin Leakage			3	μA		

Note 1: SHDN must transition faster than 1V/100mS for proper operation.

PIN NUMBER	PIN NAME	DESCRIPTION
1	V _{BATT}	Battery Voltage. The startup circuitry is powered by this pin. Battery Voltage is used to calculate switch off time: $t_{OFF} = K_{OFF} / (V_{OUT} - V_{BATT})$. When the battery voltage drops below 0.61V the SP6648 goes into an undervoltage lockout mode (UVLO), where the part is shut down.
2	LBI	Low Battery Input. LBI below 0.61V causes the SP6648 pin to pull LBON pin down to ground. Use a resistor divider to program the low voltage threshold for a specific battery configuration.
3	LBON	Low Battery Output Not. Open drain NMOS output that sinks current to ground when LBI is below 0.61V.
4	R _{LIM}	Current Limit Resistor. By connecting a resistor R _{LIM} from this pin to ground the inductor peak current is set by $I_{PEAK} = 1600 / R_{LIM}$. The range for R _{LIM} is 9kΩ (for 180mA) to 1.KΩ (for 1.6A).
5	SHDN	Shutdown Not. Tie this pin high to V _{BATT} , for normal operation. Pull this pin to ground to disable all circuitry inside the chip. In shutdown the output voltage will float down to a diode drop below the battery voltage.
6	FB	Feedback. Connect this pin to GND for fixed +3.3V operation. Connect this pin to a resistor voltage divider between V _{OUT} and GND for adjustable output operation.
7	GND	Ground. Connect to ground plane.
8	PGND	Power Ground. The inductor charging current flows out of this pin.
9	LX	Inductor Switching Node. Connect one terminal of the inductor to the positive terminal of the battery. Connect the second terminal of the inductor to this pin. The inductor charging current flows into LX, through the internal charging N-channel FET, and out the PGND pin.
10	V _{OUT}	Output Voltage. The inductor current flows out of this pin during switch off-time. It is also used as the internal regulator voltage supply. Connect this pin to the positive terminal of the output capacitor.

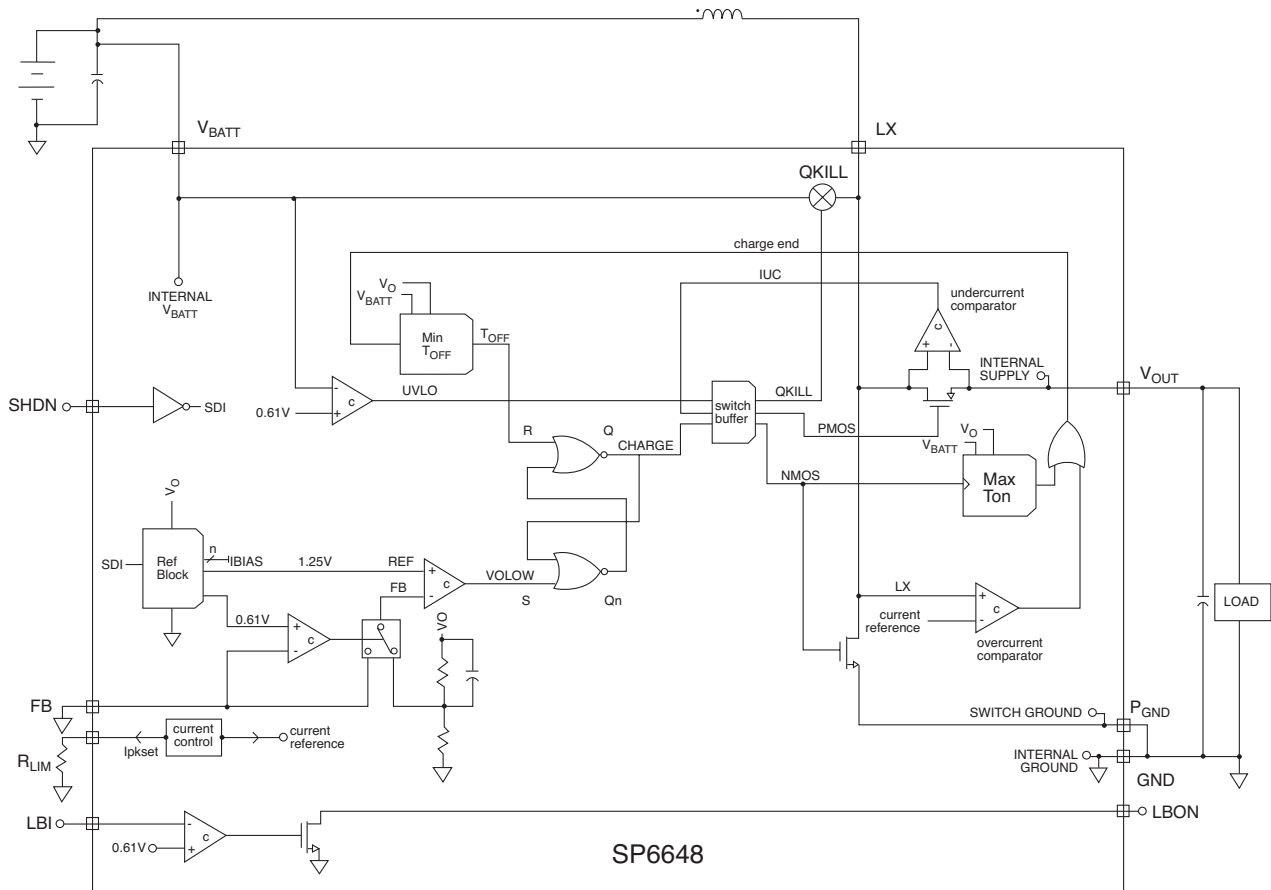

THEORY OF OPERATION

Detailed Description

The SP6648 is a step-up DC-DC converter that can start up with input voltages as low as 0.85V (typically) and operates with an input voltage down to 0.61V. Ultra low quiescent current of 12µA provides excellent efficiency, up to 94%. In addition to the main switch, a 0.3Ω internal MOSFET the SP6648 has an internal synchronous rectifier, increasing efficiency and reducing the space requirements of an external diode. An internal inductive-damping switch significantly reduces inductive ringing for low-noise, high efficiency operation. If the supply voltage drops below 0.61V the SP6648 goes into under voltage lock-out mode, thus opening both internal switches. An externally programmable low battery detector with open drain output provides the ability to flag a battery-low condition. The inductor peak current is externally programmable to allow for a range of inductor values.

Control Scheme

A minimum off-time, current limited pulse frequency modulation (PFM) control scheme combines the high output power and efficiency of a pulse width modulation (PWM) device with the ultra low quiescent current of the traditional PFM. At low to moderate output loads, the PFM control provides higher efficiency than traditional PWM converters are capable of delivering. At these loads, the switching frequency is determined by a minimum off-time ($t_{OFF, MIN}$) and a maximum on-time ($t_{ON, MAX}$) where:

$$t_{OFF} \geq K_{OFF} / (V_{OUT} - V_{BATT}) \text{ and}$$

$$t_{ON} \leq K_{ON} / V_{BATT} \text{ with}$$

$$K_{OFF} = 1.0V\mu s \text{ and}$$

$$K_{ON} = 4.0V\mu s.$$

At light loads (as shown in plot A in *Figure 1*) the charge cycle will last the maximum value for t_{ON} : For a 1V battery this would be as follows:

$$t_{ON} = K_{ON} / V_{BATT} = 4.0V\mu s / 1V = 4.0\mu s$$

The current built up in the coil during the charge cycle gets fully discharged in the discontinuous conduction mode (DCM). When the current in the coil has reached zero, the synchronous rectifier switch is opened and the voltage across the coil (from V_{BATT} to LX) is shorted internally to eliminate inductive ringing.

With increasing load (as shown in plot B in *Figure 1*) this inductor damping time becomes shorter, because the output will quickly drop below its regulation point due to heavier load. If the load current increases further, the SP6648 enters continuous conduction mode (CCM) where there is always current flowing in the inductor. The charge time remains at maximum t_{ON} as long as the inductor peak current limit is not reached as shown in plot C in *Figure 1*. The inductor peak current limit can be programmed by tying a resistor R_{LIM} from the R_{LIM} pin to ground where:

$$I_{PEAK} = 1600 / R_{LIM}$$

When the peak current limit is reached the charge time is short-cycled.

In plot D of *Figure 1*, the switch current reaches the peak current limit during the charge period

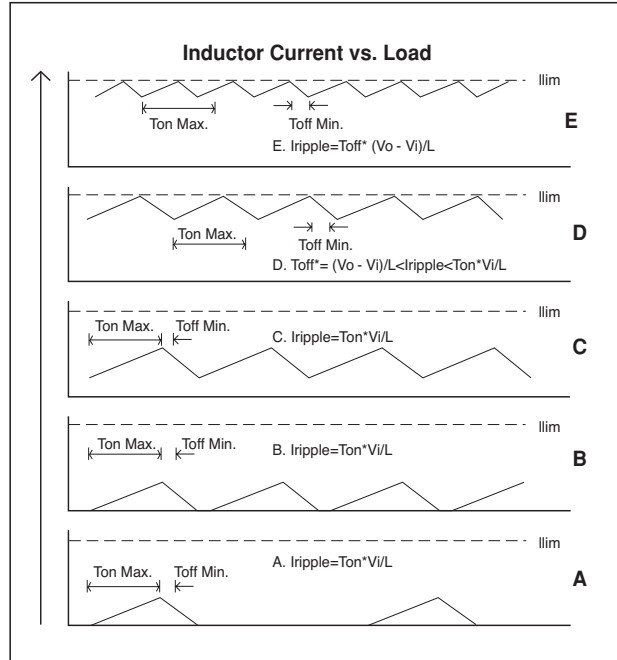

Figure 1. Inductor Current vs. Load

which ends the charge cycle and starts the discharge cycle. However, full load is not yet achieved because at the end of the minimum discharge time the output was still within regulation.

Maximum load is reached when this discharge time has shrunk to the minimum allowed value T_{OFF} as shown in Plot E of *Figure 1*.

TYPICAL PERFORMANCE CHARACTERISTICS

Refer to the Typical Application Circuit on page 1, $T_{AMB}=+25^{\circ}\text{C}$.

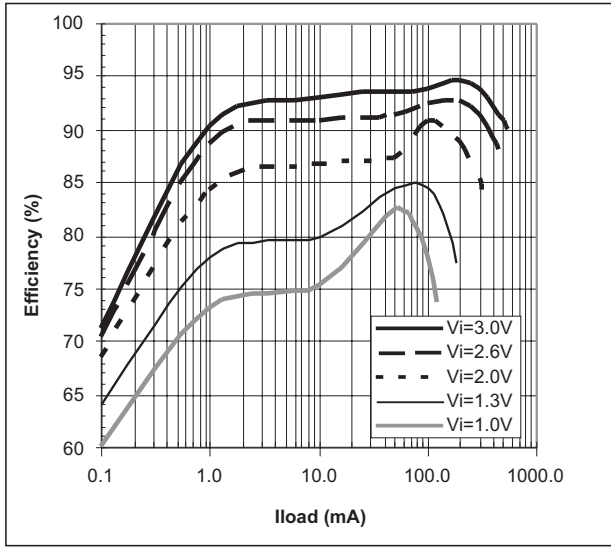

Efficiency vs. Load Current, $V_{OUT}=3.3\text{V}$

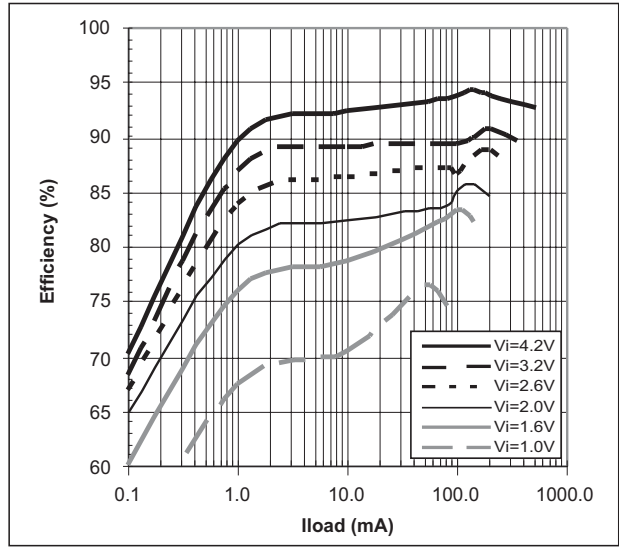

Efficiency vs. Current Load, $V_{OUT}=5.0\text{V}$

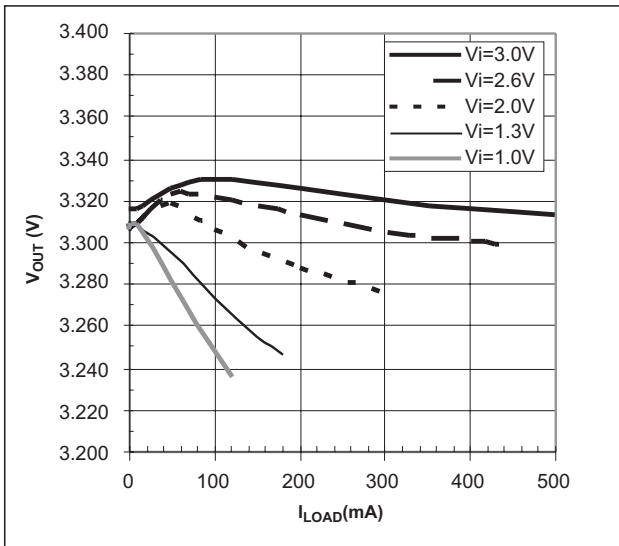

Line/Load Rejection vs. Load Current, $V_{OUT}=3.3\text{V}$

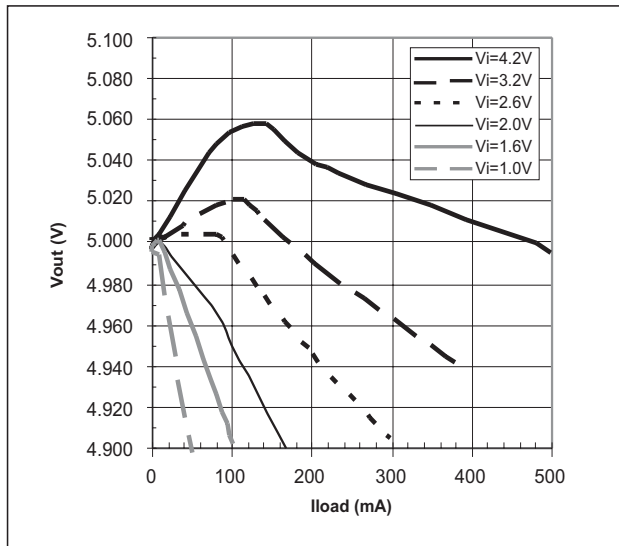

Line/Load Rejection vs. Load Current, $V_{OUT}=5.0\text{V}$

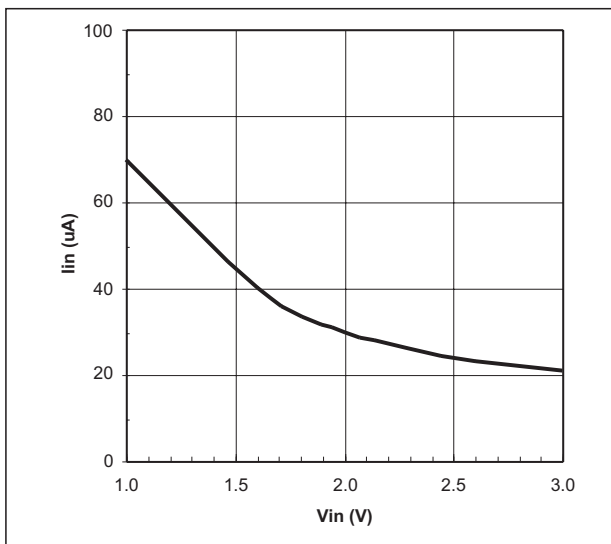

No Load Battery Current, $V_{OUT}=3.3\text{V}$

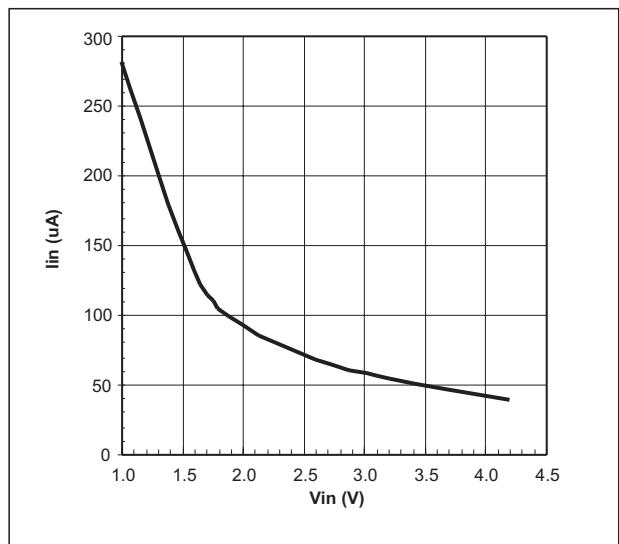

No Load Battery Current, $V_{OUT}=5.0\text{V}$

TYPICAL PERFORMANCE CHARACTERISTICS

Refer to the Typical Application Circuit on page 1, $T_{AMB}=+25^{\circ}\text{C}$.

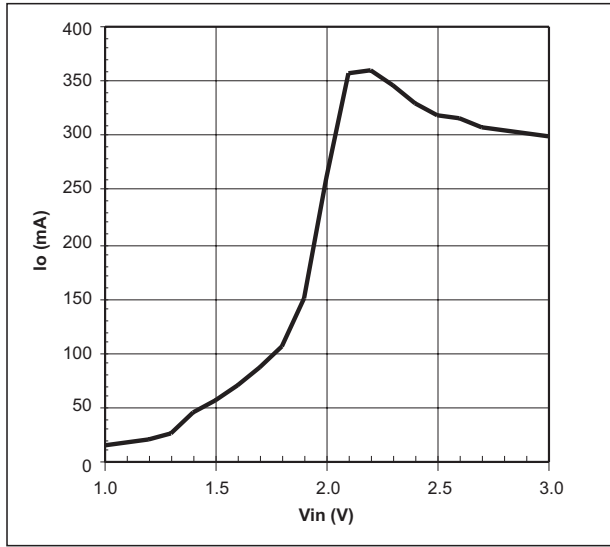

Maximum Resistive Load Current in Startup, $V_{OUT}=3.3\text{V}$

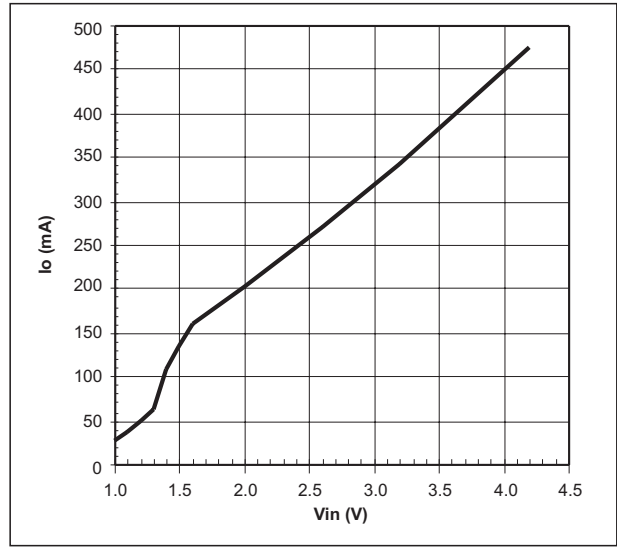

Maximum Resistive Load Current in Startup, $V_{OUT}=5.0\text{V}$

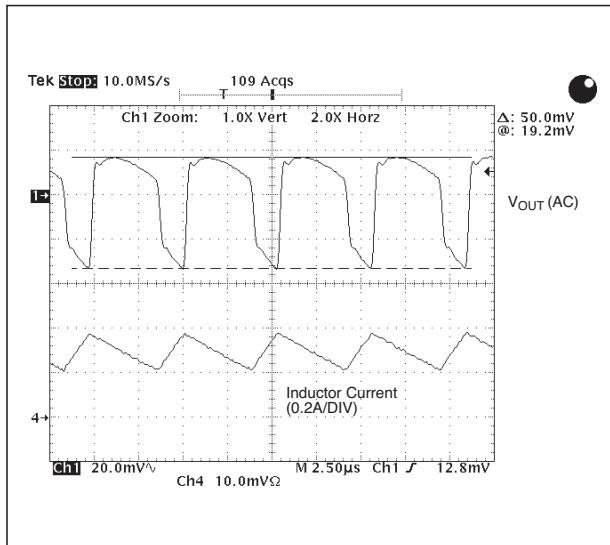

Output Ripple, $V_{IN}=2.6\text{V}$, $I_{LOAD}=200\text{mA}$, $V_{OUT}=3.3\text{V}$

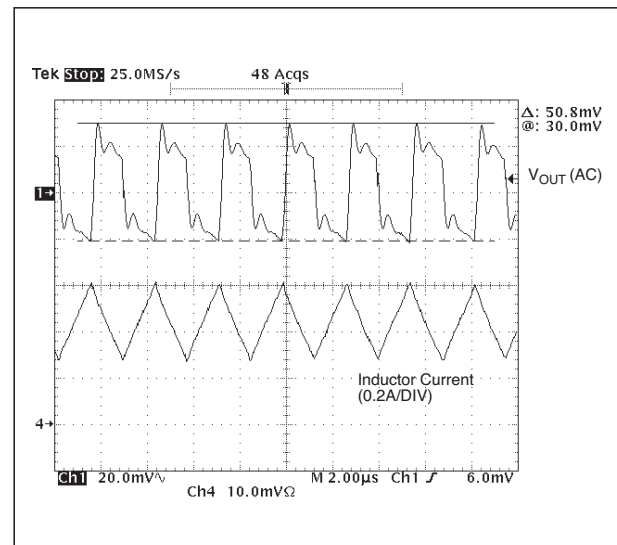

Output Ripple, $V_{IN}=2.6\text{V}$, $I_{LOAD}=200\text{mA}$, $V_{OUT}=5.0\text{V}$

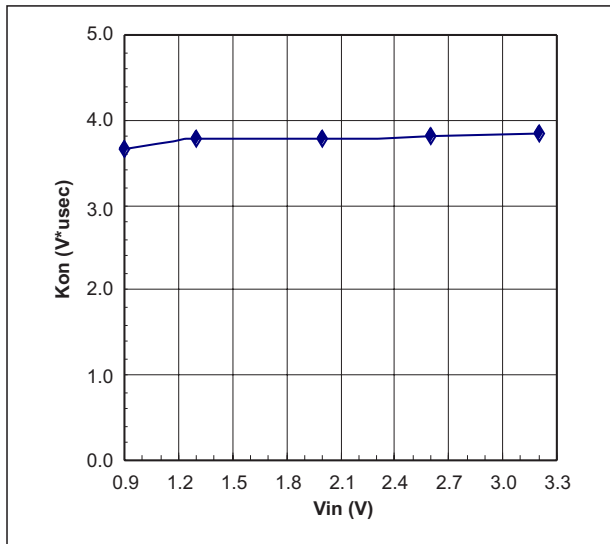

K_{ON} vs. V_{IN} , $V_{OUT}=3.3\text{V}$

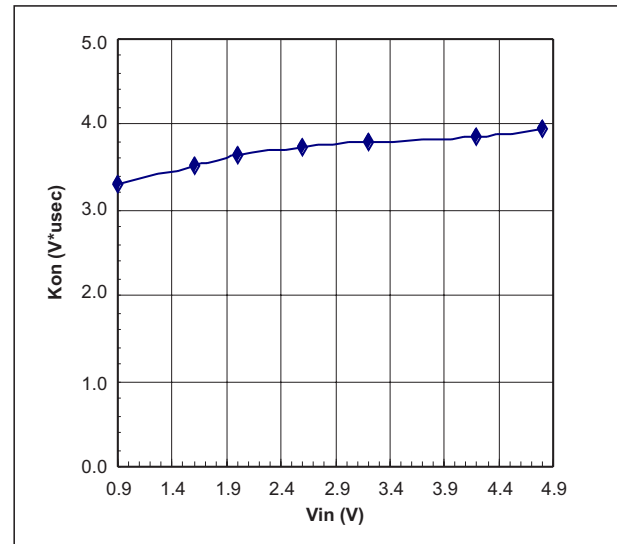

K_{ON} vs. V_{IN} , $V_{OUT}=5.0\text{V}$

TYPICAL PERFORMANCE CHARACTERISTICS

Refer to the Typical Application Circuit on page 1, $T_{AMB}=+25^{\circ}\text{C}$.

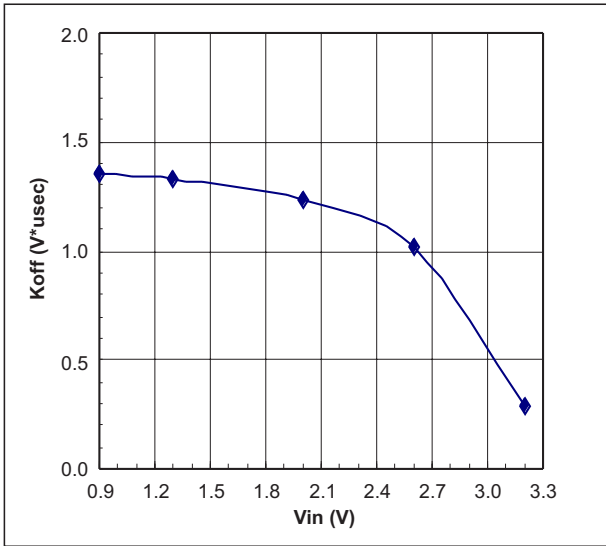

K_{OFF} vs. V_{IN} , $V_{OUT}=3.3\text{V}$

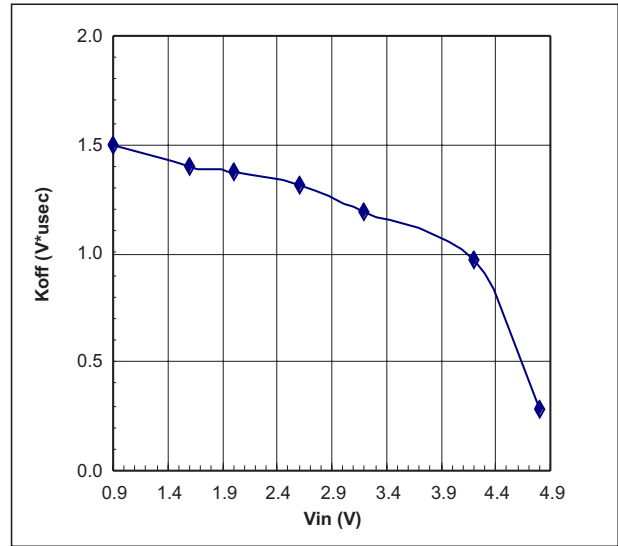

K_{OFF} vs. V_{IN} , $V_{OUT}=5.0\text{V}$

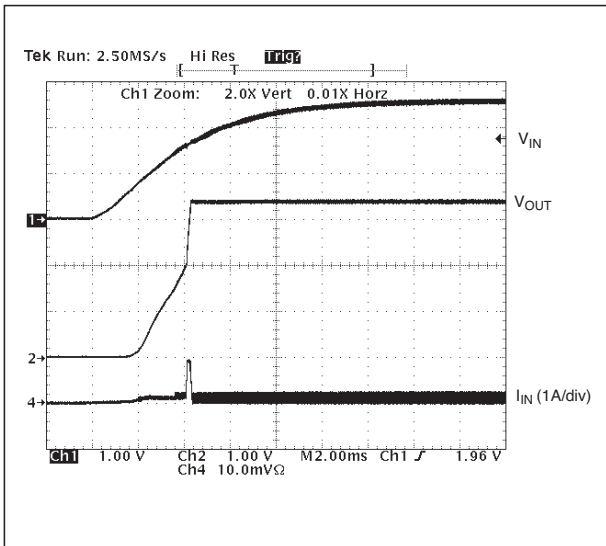

Startup, $V_{IN}=2.6\text{V}$, $V_{OUT}=3.3\text{V}$, $R_{LOAD}=100\Omega$

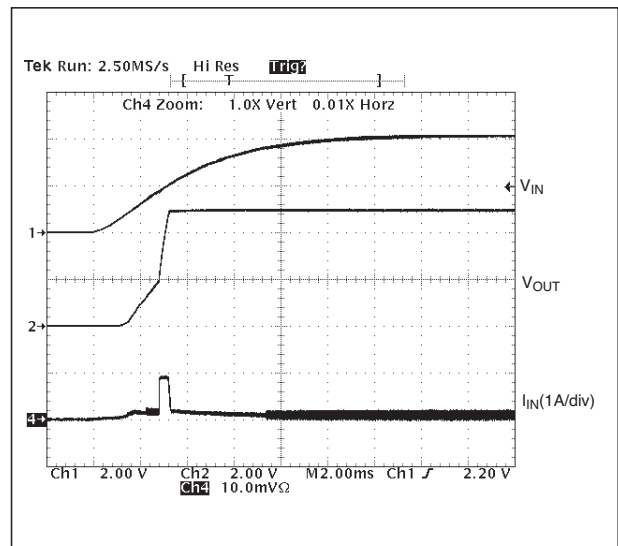

Startup, $V_{IN}=4.2\text{V}$, $V_{OUT}=5.0\text{V}$, $R_{LOAD}=100\Omega$

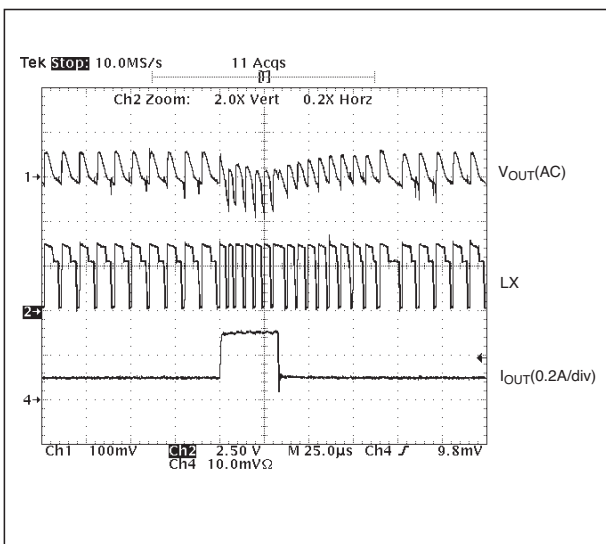

Load Step, 0.1A to 0.3A, $V_{IN}=2.6\text{V}$, $V_{OUT}=3.3\text{V}$

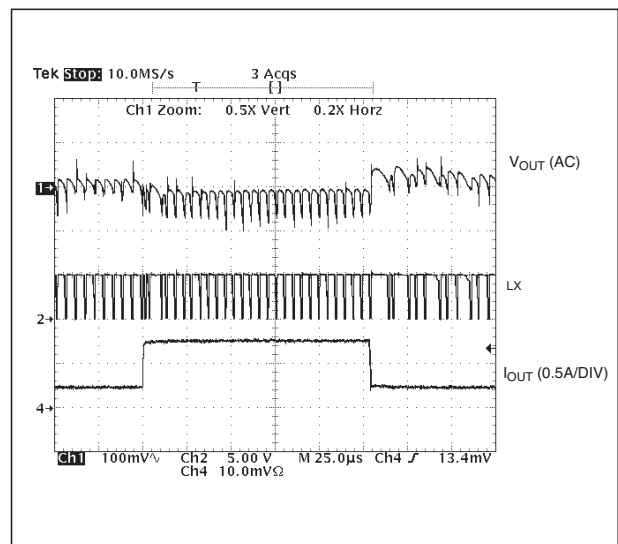

Load Step, 0.3A to 0.5A, $V_{IN}=4.2\text{V}$, $V_{OUT}=5.0\text{V}$

Circuit Layout

Printed circuit board layout is a critical part of a power supply design. Poor designs can result in excessive EMI on the feedback paths and on the ground planes with applications involving high switching frequencies and large peak currents. Excessive EMI can result in instability or regulation errors. All power components should be placed on the PC board as closely as possible with the traces kept short, direct, and wide (>50mils or 1.25mm). Extra copper on the PC board should be integrated into ground as a pseudo-ground plane. On a multilayer PC board, route the star ground using component-side copper fill, then connect it to the internal ground plane using vias. For the SP6648 devices, the inductor and input- and output-filter capacitors should be soldered with their ground pins as close together as possible in a star-ground configuration. The V_{OUT} pin must be bypassed directly to ground as close to the SP6648 devices as possible (within 0.2in or 5mm). The DC-DC converter and any digital circuitry should be placed on the opposite corner of the PC board as far away from sensitive RF and analog input stages. Noisy traces, such as from the LX pin, should be kept away from the voltage-feedback V_{OUT} node and separated from it using grounded copper to minimize EMI. See the SP6648EB Evaluation Board Manual for PC Board Layout design details.

Component Selection

Selection of capacitors for SP6648 power supply circuits can be made through the use of the Component Selection Table. Capacitor equivalent series resistance (ESR) in the range of 0.2 Ω to 0.3 Ω is a requirement for obtaining sufficient output voltage ripple for the SP6648 to properly regulate under load. For ESR values in this range, low ESR tantalum capacitors are recommended. For example, in the SP6648 application circuit a 47 μ F, 10V, low-ESR, surface-mount tantalum output filter capacitor typically provides 50mV output ripple when stepping up from 2.6V to 3.3V at 200mA. Ceramic capacitors have ESR too low to produce enough output

ripple for the SP6648 to regulate the output. Designers should select input and output capacitors with a rating exceeding the inductor current ripple, which is typically set by the inductor value and the K_{ON} value as given in the following relationship:

$$I_{L(RIPPLE)} = K_{ON}/L$$

For the example of the 10 μ H inductor the inductor current ripple would be 330mA, while for the 22 μ H inductor the inductor current ripple value would be 150mA. Do not allow tantalum capacitors to exceed their ripple-current ratings. An input filter capacitor can reduce peak currents drawn from the battery and improve efficiency. For most applications, use the same 47 μ F tantalum capacitor as used for the input. Low-ESR aluminum electrolytic capacitors are acceptable, provided they meet the ESR requirement of 0.2 Ω to 0.3 Ω , and we list an appropriate 100 μ F aluminum electrolytic in the component selection table, but standard aluminum electrolytic capacitors are not recommended.

In selecting an inductor, the saturation current specified for the inductor needs to be greater than the SP6648 peak current to avoid saturating the inductor, which would result in a loss in efficiency and could damage the inductor. The SP6648 evaluation board uses a Sumida CDRH5D28 10 μ H inductor with an I_{SAT} value of 1.3A and a DCR of 0.065 Ω , which easily handles the I_{PEAK} of 0.85A of the SP6648 and will deliver high efficiencies. Other inductors could be selected provided their I_{SAT} is greater than the I_{PEAK} of the SP6648.

INDUCTORS - SURFACE MOUNT							
Inductor Specification							
Inductance (μH)	Manufacturer/Part No.	Series R Ω	I _{SAT} (A)	Size LxWxH (mm)	Intuctor Type	Manufacturer Website	
10	Sumida CDRH5D28-100	0.065	1.30	5.7x5.5x3.0	Shielded Ferrite Core	www.sumida.com	
10	TDK RLF5018T-100MR94	0.067	0.94	5.6x5.2x2.0	Shielded Ferrite Core	www.tdk.com	
10	Sumida CD43-100	0.180	1.04	4.0x4.5x3.5	Unshileded Ferrite Core	www.sumida.com	
22	Sumida CDRH5D28-220	0.122	0.90	5.7x5.5x3	Shileded Ferrite Core	www.sumida.com	
22	TDK RLF5018T-220MR63	0.067	0.63	5.6x5.2x2.0	Shielded Ferrite Core	www.tdk.com	
22	Sumida CD43-220	0.378	0.68	4.0x4.5x3.5	Unshielded Ferrite Core	www.sumida.com	

CAPACITORS - SURFACE MOUNT & LEADED							
Capacitor Specification							
Capacitance (μF)	Manufacturer Part No.	ESR Ω(max)	Ripple Current (A) @ 85°C	Size LxWxH (mm)	Voltage (V)	Capacitor Type	Manufacturer Website
47	Kemet T494C476K010AS	0.300	1.06	6.0x3.2x2.5	10	SMT Tantalum	www.kemet.com
47	Kemet T494V476K010AS	0.300	0.99	7.3x4.3x2.0	10	SMT Tantalum	www.kemet.com
100	Sanyo 25MV100AX	0.220	0.30	6.3DX11L	25	Radial Al Electrolytic	www.sanyovideo.com

Note: Components highlighted in **bold** are those used on the SP6648EB Evaluation Board.

Component Selection Table

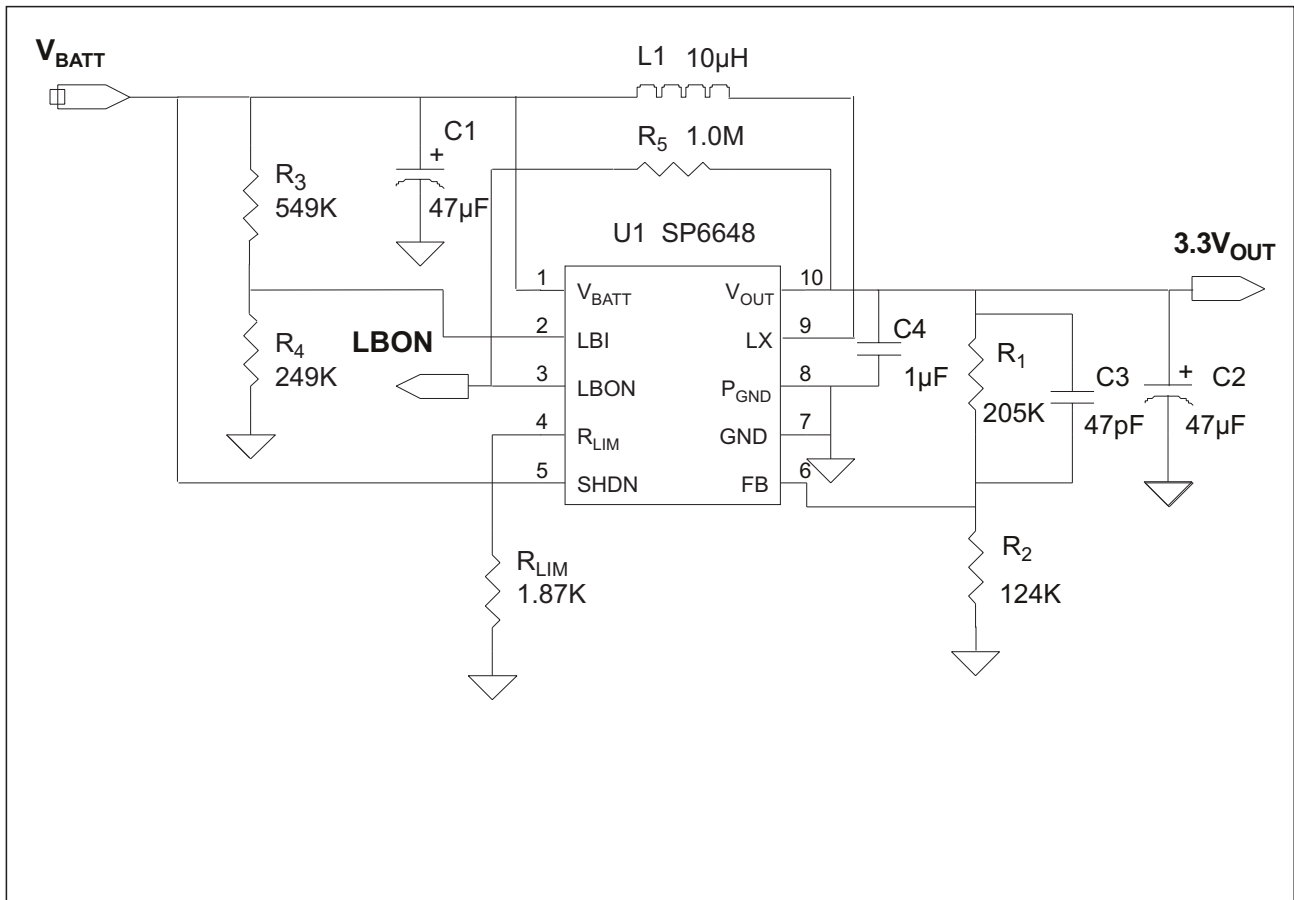

SP6648EB Evaluation Board Schematic

V_{OUT} Programming

The SP6648 can be programmed as either a voltage source or a current source. To program the SP6648 as a voltage source, the SP6648 requires 2 feedback resistors R1 & R2, as shown in the SP6648EB evaluation board schematic, to control the output voltage. To set V_{OUT} in the voltage mode, use the equation:

$$R1 = [(V_{OUT}/1.25)-1] * R2$$

Using the R_{LIM} Function

The peak inductor current, I_{PEAK}, is programmed externally by the R_{LIM} resistor connected between the R_{LIM} pin and GND. The peak inductor current is defined by:

$$I_{PEAK} = 1600/R_{LIM}$$

The saturation current specified for the inductor needs to be greater than the peak current to avoid saturating the inductor, which would result in a loss in efficiency and could damage the inductor. The SP6648 evaluation board uses a R_{LIM} value of 1.87K for an I_{PEAK} = 850mA to allow the circuit to deliver up to 180mA for 1.3V input and 400mA for 2.6V input. Other values could be selected using the above relationships.

Using the LBON - Low Battery Output Function

The SP6648 will regulate the output until the input battery is completely discharged or until the under voltage lock-out (UVLO) occurs at V_{BATT} = 0.61V. To provide a low battery warning, the Low Battery Output function of the SP6648 can be used. LBON is programmed externally by the R₃ and R₄ resistor divider connected between V_{BATT}, the LBI input pin and GND. The LBON is an open drain output, which is active low and is pulled up by a 1MΩ

resistor R₅ to V_{OUT}. When the LBI comparator falling threshold of 0.61V is reached, the LBON output goes low as determined by the relationship:

$$V_{LOWBATT} = 0.61 * [(R_3 + R_4)/R_4]$$

The SP6648 evaluation board R₃ & R₄ resistors have been set to trip for a falling battery threshold of about 2.0V. Using this relationship, other low battery threshold values can be set by the user.

UVLO the Under Voltage Lock-Out Function

Once started up, the SP6648 will regulate the output until the input battery is completely discharged or until the under voltage lock-out (UVLO) occurs at V_{BATT} = 0.61V. The UVLO function will completely open all switches until the battery again rises above the 0.61V threshold.

Maximum Startup Current

It should be noted that for low input voltages the SP6648 startup circuit cannot support large load currents at startup. In startup the SP6648 needs to boost the output from zero volts using the input voltage. Once the output is greater than 1.9V, the operating circuit takes over and the SP6648 can supply much more current. Curves of maximum load current in startup for the SP6648 are shown in the typical performance characteristics and can be compared with the page one curve for maximum load current in operation.

For 1-cell battery applications, it is recommended to apply any large load current after the SP6648 has started up, typically in a few milliseconds. This is typically not a problem in many applications where the load is a processor whose load current is low until the processor voltage comes up.

SP6648LEDEB Evaluation Board with LumiLED High Brightness White LED

For the high brightness LumiLED white LED application, the SP6648 is generally programmed as a current source. The bias resistor R_b is used to set the operating current of the white LED in the equation:

$$R_b = V_{REF} / I_F$$

where V_{REF} is around 0.61V, I_F is the operating current of the LumiLED. To set the operating current to be about 350mA, R_b is selected as 1.8 Ω as shown in the following schematic. The efficiency of the SP6648 LumiLED circuit is improved by the use of a silicon diode D1 and resistor R_1 to set the voltage at the current sense resistor R_2 to 0.61V instead of the higher 1.25V at the FB pin. An efficiency curve follows showing the SP6648 efficiency driving 350mA output current into the high brightness LumiLED.

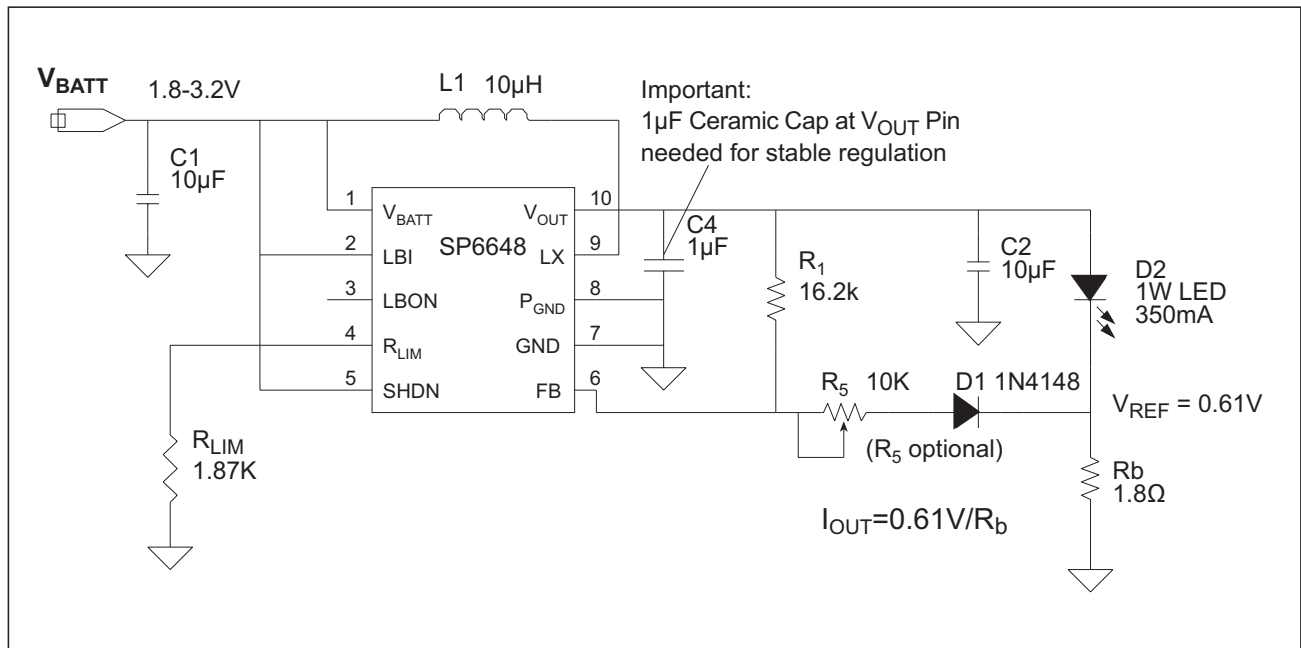

SP6648LEDEB Evaluation Board Schematic

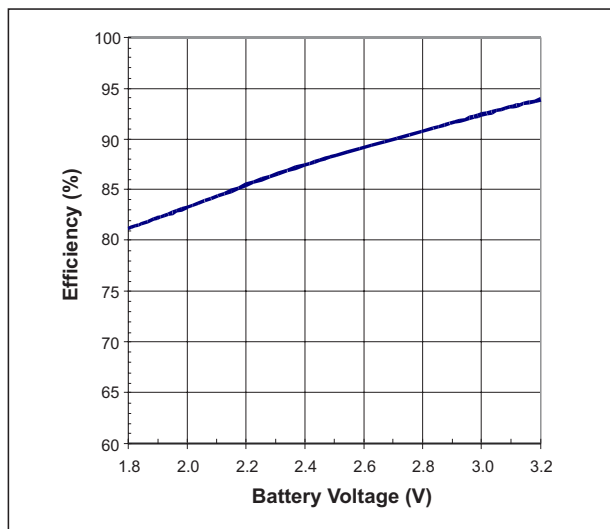

SP6648LEDEB Efficiency Curve

As shown in following scope photos, if the SP6648 is powered up before the LumiLED is plugged in, the circuit will bring the Feedback pin to 0.0V and the SP6648 has a feature to set the output voltage to be 3.3V. Once the LumiLED is plugged in, the Feedback pin will go up to 1.25V and begin to regulate. The output voltage will go from 3.3V to 3.68V (= $V_F + 0.61V$), where V_F is the forward voltage of the LumiLED. When the LumiLED is open, the Feedback pin voltage will go to 0.0V and the output voltage will go to 3.3V which will protect the part.

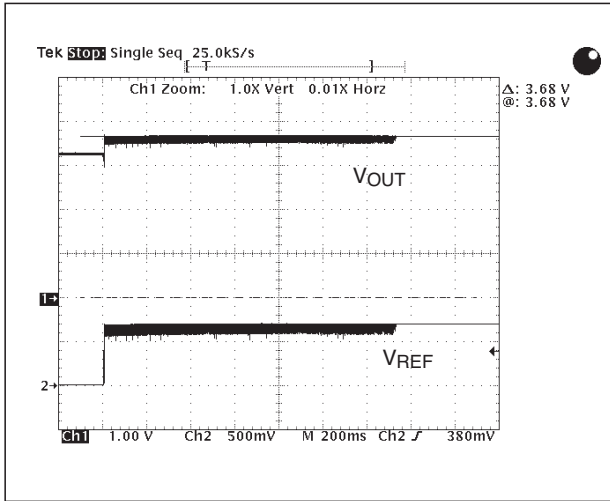

Plug in the LumiLED

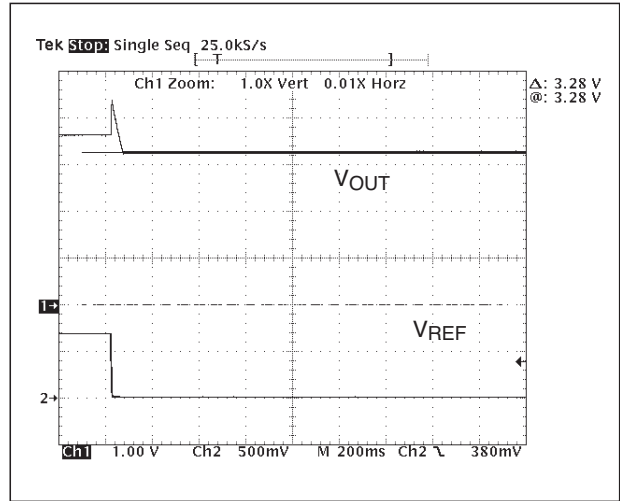

Unplug the LumiLED

Brightness Control

One approach to control LED brightness is to apply a PWM signal to the SHDN input of the SP6648. In this case, the output current will be equal to the product of 350mA and the average duty cycle at the SHDN pin. An optional 10KΩ potentiometer (R₅) may also be used for dimming the LED current by varying the potentiometer between low brightness and full brightness.

PINOUTS

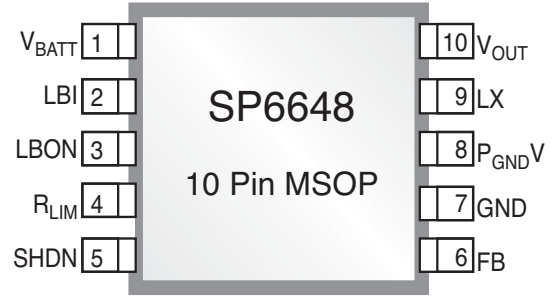
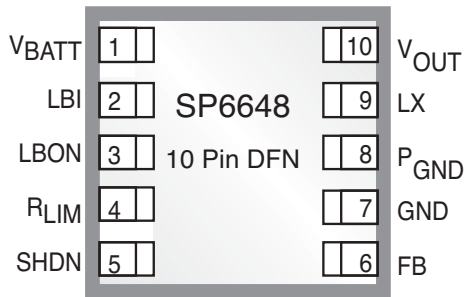

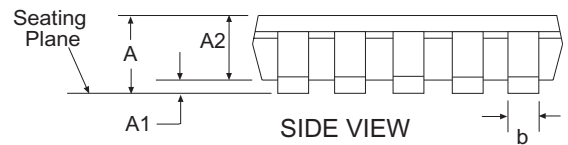
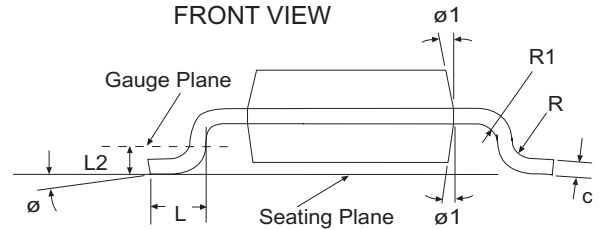
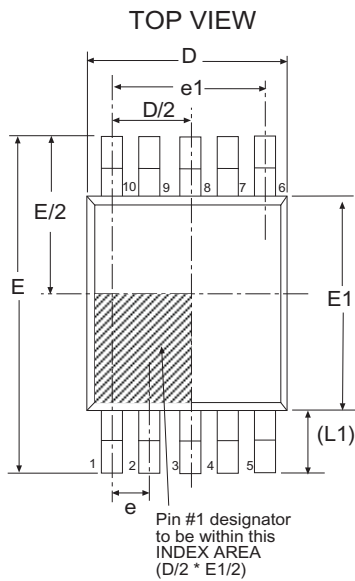

10 Pin MSOP JEDEC MO-187 Variation BA						
SYMBOL	Dimensions in Millimeters: Controlling Dimension			Dimensions in Inches Conversion Factor: 1 Inch = 25.40 mm		
	MIN	NOM	MAX	MIN	NOM	MAX
A1	0.00	-	0.15	0.000	-	0.006
c	0.08	-	0.23	0.004	-	0.009
R	0.07	-	-	0.003	-	-
R1	0.07	-	-	0.003	-	-
ϕ	0°	-	8°	0°	-	8°
$\phi 1$	5°	-	15°	5°	-	15°
A	-	-	1.10	-	-	0.043
A2	0.75	0.85	0.95	0.030	0.034	0.038
b	0.17	-	0.33	0.007	-	0.013
D	3.00 BSC			0.118 BSC		
E	4.90 BSC			0.193 BSC		
E1	3.00 BSC			0.118 BSC		
e	0.50 BSC			0.020 BSC		
e1	2.00 BSC			0.079 BSC		
L	0.40	0.60	0.80	0.016	0.024	0.032
L1	0.95 REF			0.037 REF		
L2	0.25 BSC			0.010 BSC		
SIPEX Pkg Signoff Date/Rev:				JL Aug09-05 RevA		

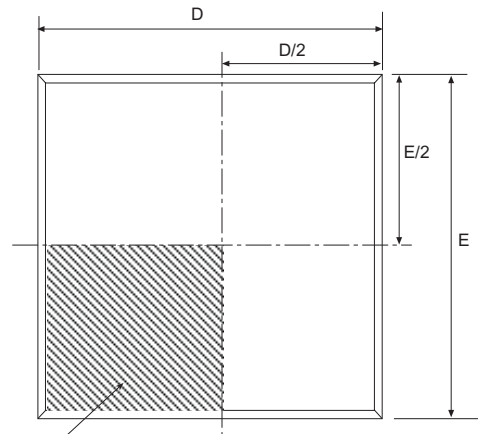

Pin1 Designator
to be within this
INDEX AREA
(D/2 x E/2)

TOP VIEW

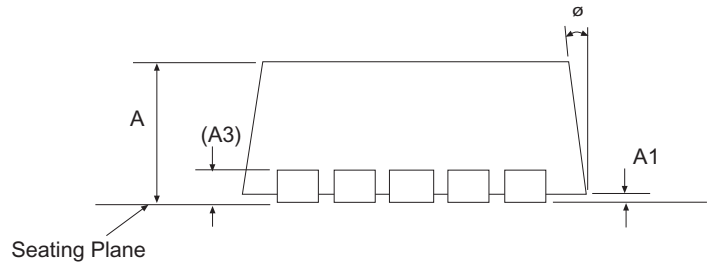

SIDE VIEW

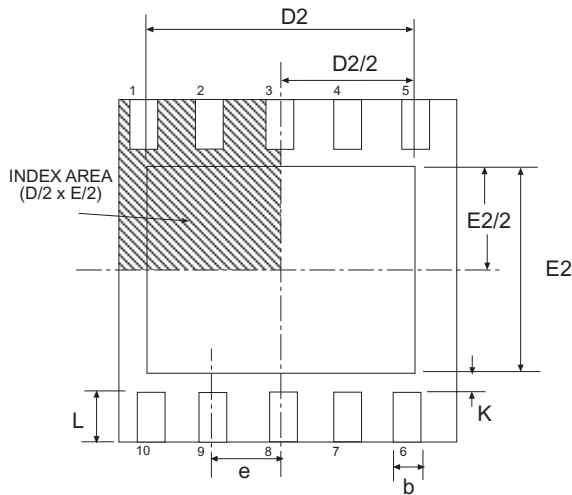

BOTTOM VIEW

3x3 10 Pin DFN		JEDEC MO-229		VARIATION VEED-5		
SYMBOL	Dimensions in Millimeters: Controlling Dimension			Dimensions in Inches Conversion Factor: 1 Inch = 25.40 mm		
	MIN	NOM	MAX	MIN	NOM	MAX
A	0.80	0.90	1.00	0.032	0.036	0.039
A1	0.00	0.02	0.05	0.000	0.001	0.002
A3	0.20 REF			0.008 REF		
K	0.20	-	-	0.008	-	-
∅	0°	-	14°	0°	-	14°
b	0.18	0.25	0.30	0.008	0.010	0.012
D	3.00 BSC			0.119 BSC		
D2	2.20	-	2.70	0.087	-	0.106
E	3.00 BSC			0.119 BSC		
E2	1.40	-	1.75	0.056	-	0.069
e	0.50 BSC			0.020 BSC		
L	0.30	0.40	0.50	0.012	0.016	0.020
SIPEX Pkg Signoff Date/Rev:				JL Aug09-05 / RevA		

ORDERING INFORMATION

Part Number	Top Mark	Operating Temperature Range	Package Type
SP6648EU	SP6648EU.....	-40°C to +85°C	10 Pin MSOP
SP6648EU/TR	SP6648EU.....	-40°C to +85°C	10 Pin MSOP
SP6648ER	SP6648ERYWW.....	-40°C to +85°C	10 Pin DFN
SP6648ER/TR	SP6648ERYWW.....	-40°C to +85°C	10 Pin DFN

Available in lead free packaging. To order add "-L" suffix to part number.

Example: SP6648EU/TR = standard; SP6648EU-L/TR = lead free

/TR = Tape and Reel

Pack quantity is 2,500 for MSOP and 3,000 for DFN.



Sipex Corporation

**Headquarters and
Sales Office**
233 South Hillview Drive
Milpitas, CA 95035
TEL: (408) 934-7500
FAX: (408) 935-7600

Sipex Corporation reserves the right to make changes to any products described herein. Sipex does not assume any liability arising out of the application or use of any product or circuit described herein; neither does it convey any license under its patent rights nor the rights of others.