

ASSP For Power Management Applications (Secondary battery)
**Lithium Ion Battery Charger
DC/DC Converter IC**
(High Precision with Constant-current Function)

MB3813A/MB3833A/MB3843

■ DESCRIPTION

The FUJITSU MB3813A/33A/43 are pulse width modulation (PWM) DC/DC converter ICs with independent output voltage and current setting capability.

These products are covered by US Patent Number 6,147,477.

The use of on-chip output setting resistance enables high precision output voltage control. Also, an output voltage switching feature for use with either graphite-electrode or coke-electrode lithium-ion batteries makes this IC ideal for internal battery chargers in notebook personal computers and similar applications.

Cell count	Output voltage	Part number
3-cell	12.6 V/12.3 V	MB3813A
2-cell	8.4 V/8.2 V	MB3833A
1-cell	4.2 V/4.1 V	MB3843

■ FEATURES

- Output setting resistance is on-chip for high precision output voltage : $\pm 1.0\%$
- SEL terminal enables output voltage selection

(Continued)

■ PACKAGE

16-pin plastic SSOP

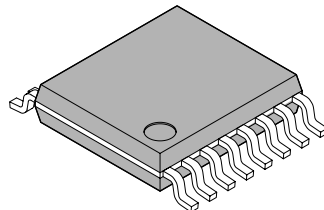

(FPT-16P-M05)

FUJITSU

MB3813A/MB3833A/MB3843

(Continued)

- High precision reference voltage source : $2.5\text{ V} \pm 1.0\%$
- High frequency operating capability : Max 500 kHz
- On-chip current detector amplifier with wide in-phase input voltage range : 0 V to V_{CC}
- On-chip standby function
- On-chip input voltage detector circuit
- On-chip soft-start control circuit
- On-chip output overshoot protection circuit for rapid load changes
- On-chip totem-pole output circuits for P-ch. MOS FET devices

■ PIN ASSIGNMENT

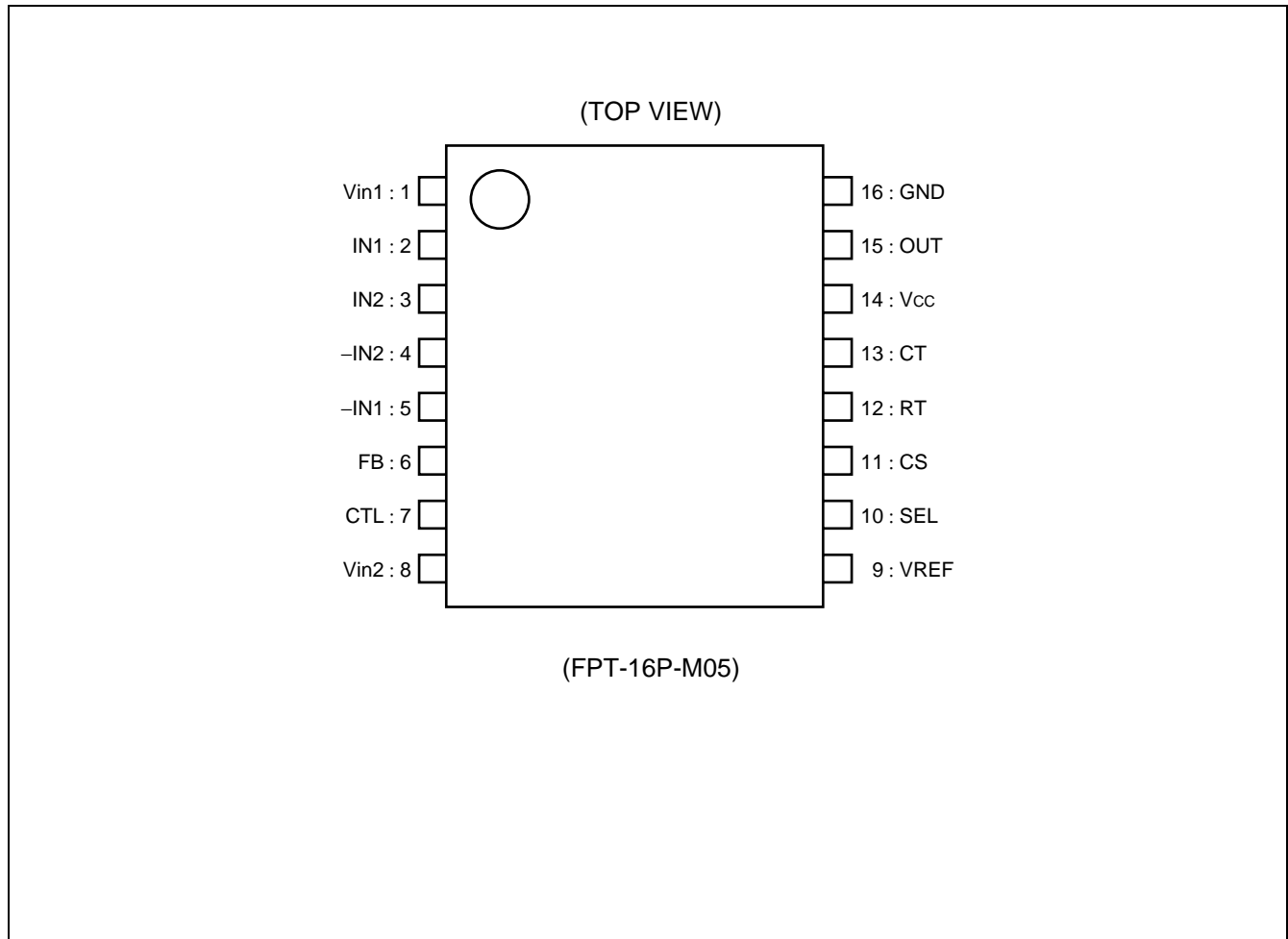

MB3813A/MB3833A/MB3843

■ PIN DESCRIPTION

Pin no.	Symbol	I/O	Descriptions
1	Vin1	I	Input voltage detector block (VLDET) input terminal
2	IN1	I	Current detector amplifier (Current Amp.) input terminal
3	IN2	I	Output voltage feedback input terminal
4	-IN2	I	Error amplifier (Error Amp.2) inverted input terminal
5	-IN1	I	Error amplifier (Error Amp.1) inverted input terminal
6	FB	O	Error amplifier (Error Amp.1, 2 common) output terminal
7	CTL	I	Power supply control terminal An "L" level signal input to the CTL terminal sets the IC in standby mode.
8	Vin2	I	DC/DC converter charging current setting input terminal
9	VREF	O	Reference voltage output terminal
10	SEL	I	Output voltage switching terminal "L" level output voltage : MB3813A 12.6 V MB3833A 8.4 V MB3843 4.2 V "H" level output voltage : MB3813A 12.3 V MB3833A 8.2 V MB3843 4.1 V
11	CS	—	Soft-start capacitor connection terminal
12	RT	—	Triangular wave frequency setting resistor connection terminal
13	CT	—	Triangular wave frequency setting capacitor connection terminal
14	V _{CC}	—	Power supply terminal
15	OUT	O	Totem-pole output terminal
16	GND	—	Ground terminal

MB3813A/MB3833A/MB3843

■ BLOCK DIAGRAM

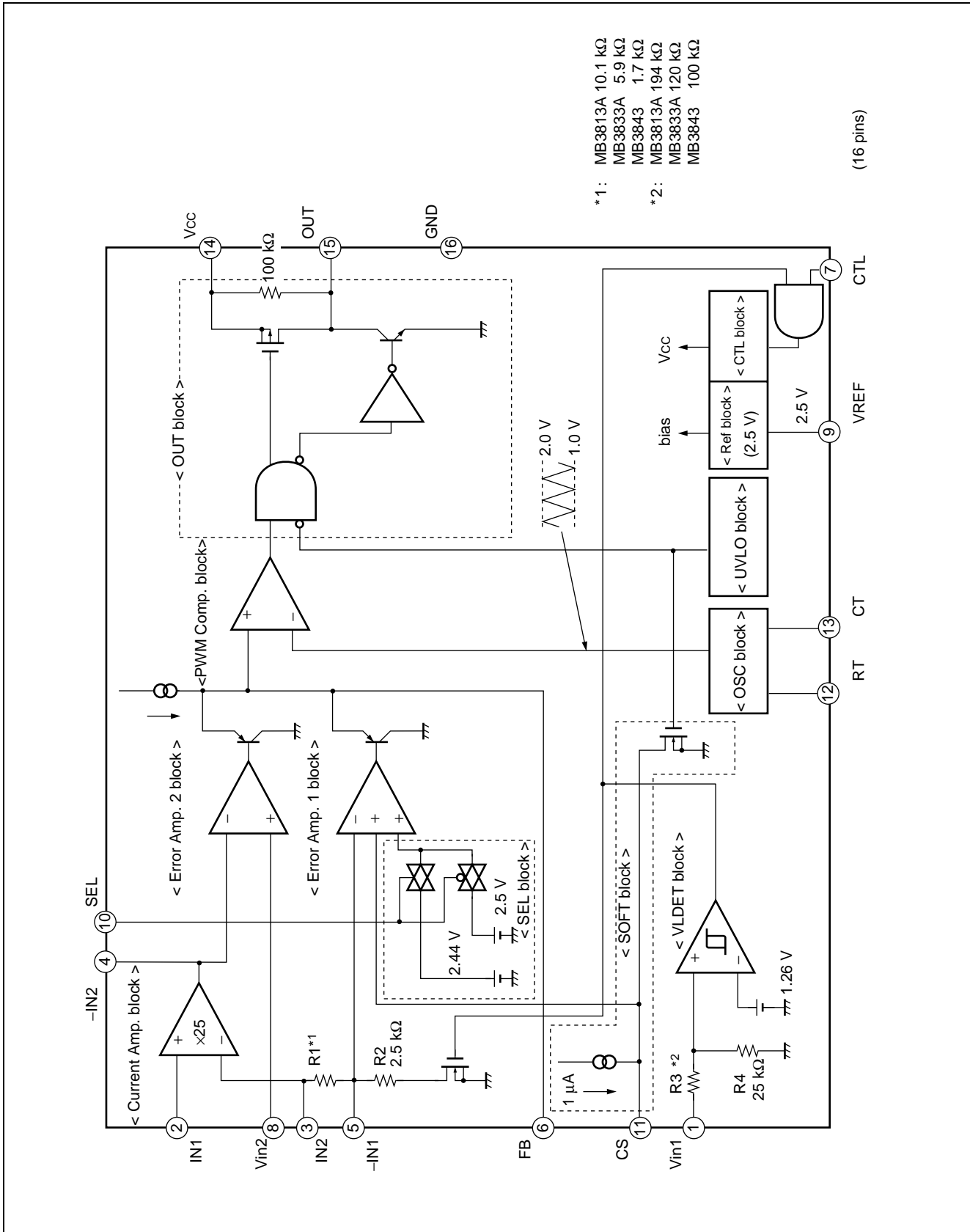

MB3813A/MB3833A/MB3843

■ ABSOLUTE MAXIMUM RATINGS

Parameter	Symbol	Condition	Rating		Unit
			Min	Max	
Power supply voltage	V _{CC}	—	—	20	V
Input voltage	V _{IN}	V _{in1} , IN1, IN2	—	20	V
Control input voltage	V _{CTL}	—	—	20	V
Select input voltage	V _{SEL}	—	—	20	V
Output current	I _o	—	—	50	mA
Peak output current	I _o	Duty ≤ 5% (t = f _{osc} × Duty)	—	500	mA
Allowable dissipation	P _D	T _a ≤ +25 °C	—	440*	mW
Storage temperature	T _{stg}	—	-55	+125	°C

* : When mounted on a 10 by 10 centimeters square dual-sided epoxy base board

WARNING: Semiconductor devices can be permanently damaged by application of stress (voltage, current, temperature, etc.) in excess of absolute maximum ratings. Do not exceed these ratings.

■ RECOMMENDED OPERATING CONDITIONS

Parameter	Symbol	Condition	Value			Unit
			Min	Typ	Max	
Power supply voltage	V _{CC}	MB3813A	12	16	18	V
		MB3833A	8	16	18	V
		MB3843	7	16	18	V
Reference voltage output current	I _{OR}	—	-1	—	0	mA
Input voltage	V _{IN}	Vin1, IN1, IN2	0	—	18	V
	V _{IN}	Vin2	0	—	2.5	V
Control input voltage	V _{CTL}	—	0	—	18	V
Select input voltage	V _{SEL}	—	0	—	18	V
Peak output current	I _O	Duty ≤ 5% (t = f _{OSC} × Duty)	-300	—	300	mA
Oscillator frequency	f _{OSC}	—	10	200	500	kHz
Soft-start capacitance	C _S	—	—	0.1	1.0	μF
Timing resistance	R _T	—	10	15	100	kΩ
Timing capacitance	C _T	—	100	330	10000	pF
Operating temperature	T _a	—	-30	25	85	°C

WARNING: The recommended operating conditions are required in order to ensure the normal operation of the semiconductor device. All of the device's electrical characteristics are warranted when the device is operated within these ranges.

Always use semiconductor devices within their recommended operating condition ranges. Operation outside these ranges may adversely affect reliability and could result in device failure.

No warranty is made with respect to uses, operating conditions, or combinations not represented on the data sheet. Users considering application outside the listed conditions are advised to contact their FUJITSU representatives beforehand.

MB3813A/MB3833A/MB3843

■ ELECTRICAL CHARACTERISTICS

($V_{CC} = V_{in1} = +16\text{ V}$, $V_{SEL} = 0\text{ V}$, $T_a = +25\text{ °C}$)

Parameter	Symbol	Pin No.	Condition	Value			Unit	Remarks	
				Min	Typ	Max			
Reference voltage block (Ref)	Output voltage	V_{REF}	9	—	2.475	2.500	2.525	V	
	Input stability	Line	9	$V_{CC} = 12\text{ V to }18\text{ V}$	—	1.0	10.0	mV	MB3813A
				$V_{CC} = 8\text{ V to }18\text{ V}$	—	1.0	10.0	mV	MB3833A
				$V_{CC} = 7\text{ V to }18\text{ V}$	—	1.0	10.0	mV	MB3843
Load stability	Load	9	$V_{REF} = 0\text{ }\mu\text{A to }-500\text{ }\mu\text{A}$	—	3.0	10.0	mV		
Under voltage lockout circuit block (UVLO)	Threshold voltage	V_{TH}	9	$V_{REF} = \text{“L”} \rightarrow \text{“H”}$	1.8	2.0	2.2	V	
	Hysteresis voltage	V_H	9	—	—	0.2	0.35	V	
Input voltage detector block (VLDET)	Threshold voltage	V_{TH}	1	$V_{in1} = \text{“L”} \rightarrow \text{“H”}$	10.2	11.0	11.8	V	MB3813A
					6.7	7.3	7.9	V	MB3833A
					5.8	6.3	6.8	V	MB3843
	Hysteresis voltage	V_H	1	—	—	1.0	2.0	V	MB3813A
					—	0.7	1.4	V	MB3833A
					—	0.57	1.2	V	MB3843
	Input current	I_{IH}	1	$V_{in1} = 16\text{ V}$	—	150	300	μA	MB3813A
					—	270	540	μA	MB3833A
—					310	620	μA	MB3843	
I_{IL}					1	$V_{in1} = 0\text{ V}$	-1.0	—	1.0
Soft-start block (UVLO)	Charge current	I_{CS}	11	—	-1.4	-1.0	-0.6	μA	
Triangular wave oscillator block (OSC)	Oscillator frequency	f_{OSC}	15	$C_T = 330\text{ pF}$, $R_T = 15\text{ k}\Omega$	180	200	220	kHz	
Error amplifier (Error Amp. 1)	Threshold voltage	V_{T1}	3	$FB = 1.5\text{ V}$, $SEL = 0\text{ V}$	12.474	12.60	12.726	V	MB3813A
					8.316	8.40	8.484	V	MB3833A
					4.158	4.20	4.242	V	MB3843
			3	$FB = 1.5\text{ V}$, $T_a = -30\text{ °C to }+85\text{ °C}$	12.41	12.60	12.79	V	MB3813A
					8.27	8.40	8.53	V	MB3833A
					4.13	4.20	4.26	V	MB3843

(Continued)

MB3813A/MB3833A/MB3843

($V_{CC} = V_{in1} = +16\text{ V}$, $V_{SEL} = 0\text{ V}$, $T_a = +25\text{ }^\circ\text{C}$)

Parameter	Symbol	Pin No.	Condition	Value			Unit	Remarks	
				Min	Typ	Max			
Error amplifier (Error Amp.1)	Threshold voltage	V_{T2}	3	FB = 1.5 V, SEL = 5 V	12.177	12.30	12.423	V	MB3813A
					8.118	8.20	8.282	V	MB3833A
					4.059	4.10	4.141	V	MB3843
		V_{T2}	3	FB = 1.5 V, SEL = 5 V $T_a = -30^\circ\text{C}$ to $+85\text{ }^\circ\text{C}$	12.11	12.30	12.49	V	MB3813A
					8.07	8.20	8.33	V	MB3833A
					4.04	4.10	4.16	V	MB3843
	Input stability	Line	3	$V_{CC} = 13\text{ V}$ to 18 V , output 12.6 V	—	2.5	10.0	mV	MB3813A
		Line	3	$V_{CC} = 9\text{ V}$ to 18 V , output 8.4 V	—	2.5	10.0	mV	MB3833A
		Line	3	$V_{CC} = 7\text{ V}$ to 18 V , output 4.2 V	—	2.5	10.0	mV	MB3843
	Input current	I_{IN2}	3	IN1 = 12.7 V, IN2 = 12.6 V	—	1.0	2.0	mA	MB3813A
				IN1 = 8.5 V, IN2 = 8.4 V	—	1.0	2.0	mA	MB3833A
				IN1 = 4.3 V, IN2 = 4.2 V	—	1.0	2.0	mA	MB3843
			3	Vin1 = 0 V, IN2 = 12.6 V	-1.0	—	1.0	μA	MB3813A
				Vin1 = 0 V, IN2 = 8.4 V	-1.0	—	1.0	μA	MB3833A
				Vin1 = 0 V, IN2 = 4.2 V	-1.0	—	1.0	μA	MB3843
Input resistance	R1	3	—	7.0	10.1	13.2	k Ω	MB3813A	
				4.1	5.9	7.7	k Ω	MB3833A	
				1.2	1.7	2.3	k Ω	MB3843	
	R2	5	—	1.7	2.5	3.3	k Ω		
Error amplifier (Error Amp.2)	Input bias current	I_B	8	$V_{in2} = 0\text{ V}$	-400	-30	—	nA	
	Input offset voltage	V_{IO}	5	FB = 1.5 V	—	—	5	mV	

* : Standard design value

(Continued)

MB3813A/MB3833A/MB3843

($V_{CC} = V_{in1} = +16\text{ V}$, $V_{SEL} = 0\text{ V}$, $T_a = +25\text{ °C}$)

Parameter		Symbol	Pin No.	Condition	Value			Unit	Remarks	
					Min	Typ	Max			
Error amplifiers (Error Amp. 1, 2 common)	Voltage gain	A_v	—	DC	—	100*	—	dB		
	Frequency bandwidth	BW	—	$A_v = 0\text{ dB}$	—	800*	—	kHz		
	Output voltage	V_{OH}	6	—		2.3	2.5	—	V	
		V_{OL}	6	—		—	0.8	0.9	V	
	Output source current	I_{SOURCE}	6	FB = 1.5 V		—	-120	-60	μA	
Output sink current	I_{SINK}	6	FB = 1.5 V		0.6	2.0	—	mA		
Current detector amplifier block (Current Amp.)	Threshold voltage	V_{T1}	2	$IN2 = 3\text{ V to }V_{CC}$ $V_{T1} = IN1 - IN2$	$V_{in2} = 2.5\text{ V}$	90	100	110	mV	
			2		$V_{in2} = 0.75\text{ V}$	20	30	40	mV	
		V_{T2}	2	$IN2 = 0\text{ V}$ $V_{T2} = IN1 - IN2$	$V_{in2} = 2.5\text{ V}$	50	100	150	mV	
			2		$V_{in2} = 0.75\text{ V}$	5	30	55	mV	
	Input current	I_{IN1}	2	$IN1 = 12.7\text{ V}, IN2 = 12.6\text{ V}$	—	17	34	μA	MB3813A	
			2	$IN1 = 8.5\text{ V}, IN2 = 8.4\text{ V}$	—	17	34	μA	MB3833A	
			2	$IN1 = 4.3\text{ V}, IN2 = 4.2\text{ V}$	—	17	34	μA	MB3843	
	In-phase input voltage range	V_{CM}	2	—		0	—	V_{CC}	V	
	Voltage gain	A_v	2	$IN1 = 12.7\text{ V}, IN2 = 12.6\text{ V}$	21	25	29	V/V	MB3813A	
			2	$IN1 = 8.5\text{ V}, IN2 = 8.4\text{ V}$	21	25	29	V/V	MB3833A	
2			$IN1 = 4.3\text{ V}, IN2 = 4.2\text{ V}$	21	25	29	V/V	MB3843		
PWM comparator block (PWM)	Threshold voltage	V_{T0}	15	Duty cycle = 0%	0.9	1.0	—	V		
		V_{T100}	15	Duty cycle = 100%	—	2.0	2.1	V		
Output block (OUT)	ON resistance	R_{ON}	15	OUT = -30 mA	—	12	18	Ω		
	Output voltage	V_{OL}	15	OUT = 100 mA	—	1.0	1.4	V		
	Standby leak current	I_{LO}	15	$V_{CC} = 18\text{ V}, \text{OUT} = 18\text{ V}, \text{CTL} = 0\text{ V}$	-1.0	—	1.0	μA		

(Continued)

MB3813A/MB3833A/MB3843

(Continued)

($V_{CC} = V_{in1} = +16\text{ V}$, $V_{SEL} = 0\text{ V}$, $T_a = +25\text{ °C}$)

Parameter		Symbol	Pin no.	Condition	Value			Unit	Remarks
					Min	Typ	Max		
Power supply control block (CTL)	CTL input voltage	V_{ON}	7	Active mode	2.0	—	18	V	
	Standby mode	V_{OFF}	7	Standby mode	0	—	0.8	V	
	Input current	I_{IH}	7	CTL = 5 V	—	100	200	μA	
		I_{IL}	7	CTL = 0 V	-1.0	—	1.0	μA	
Output voltage selection block (SEL)	SEL voltage	V_{ON}	10	12.3 V output mode	2.0	—	18	V	MB3813A
		V_{ON}	10	8.2 V output mode	2.0	—	18	V	MB3833A
		V_{ON}	10	4.1 V output mode	2.0	—	18	V	MB3843
	SEL voltage	V_{OFF}	10	12.6 V output mode	0	—	0.8	V	MB3813A
		V_{OFF}	10	8.4 V output mode	0	—	0.8	V	MB3833A
		V_{OFF}	10	4.2 V output mode	0	—	0.8	V	MB3843
	Input current	I_{IH}	10	CTL = 5 V	-1.0	—	1.0	μA	
		I_{IL}	10	CTL = 0 V	-1.0	—	1.0	μA	
	Input current when power supply OFF	I_{IL}	10	$V_{CC} = 0\text{ V}$, SEL = 5 V	-1.0	—	1.0	μA	
General	Standby current	I_{CCS}	14	CTL = 0 V	—	260	390	μA	
	Power supply current	I_{CC}	14	at output voltage "H" level	—	3.4	5.4	mA	

TYPICAL CHARACTERISTICS

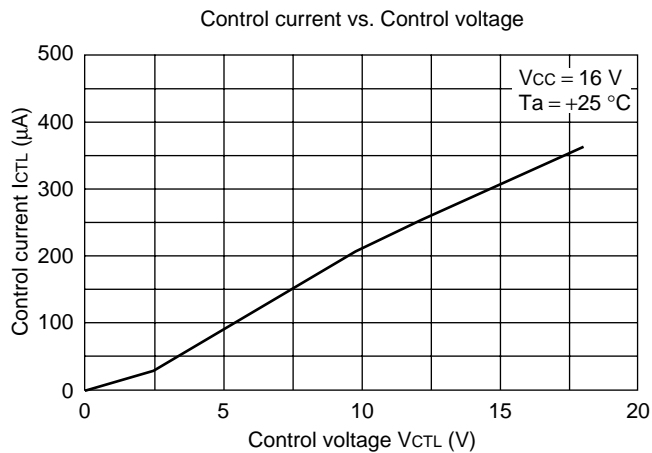
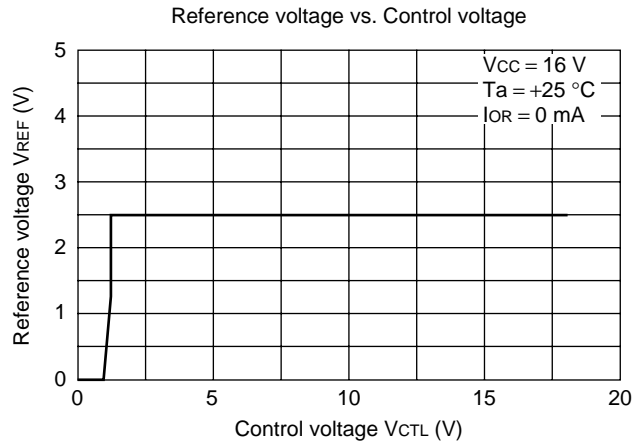
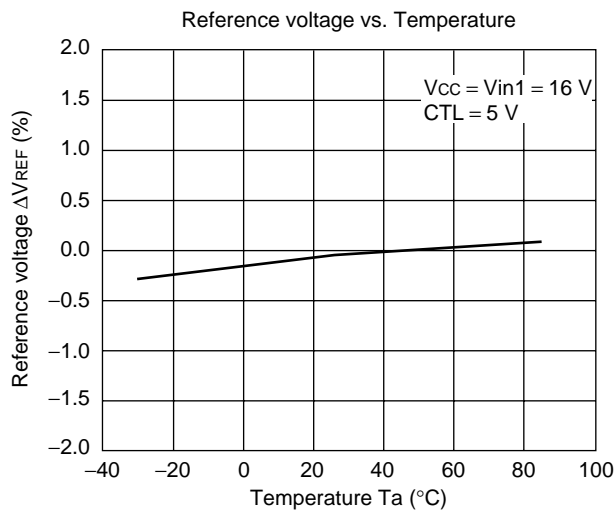
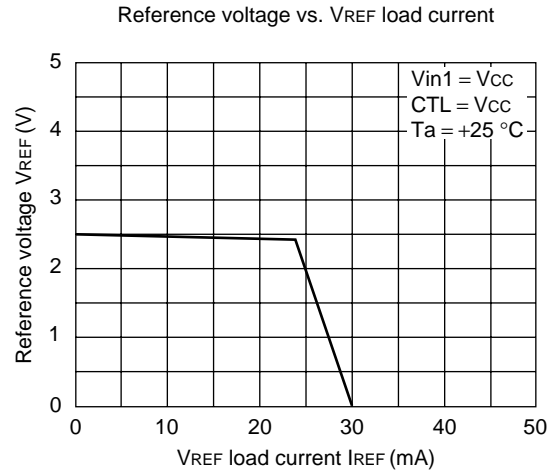
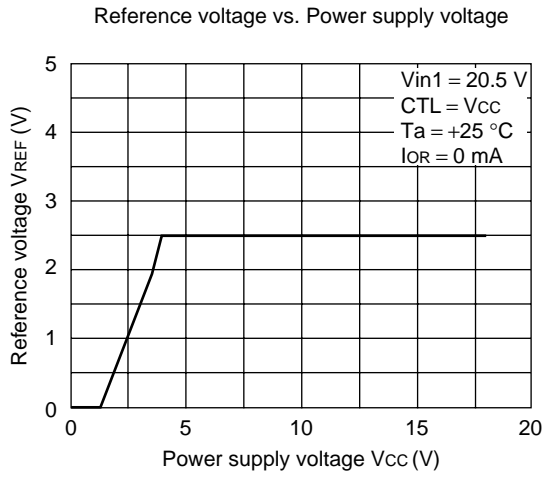

(Continued)

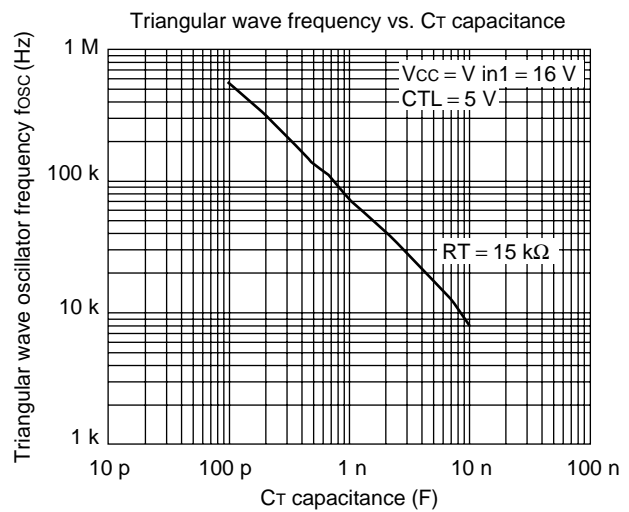
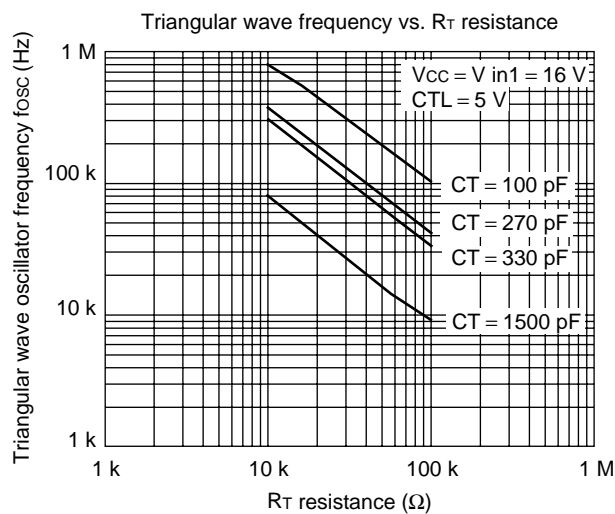
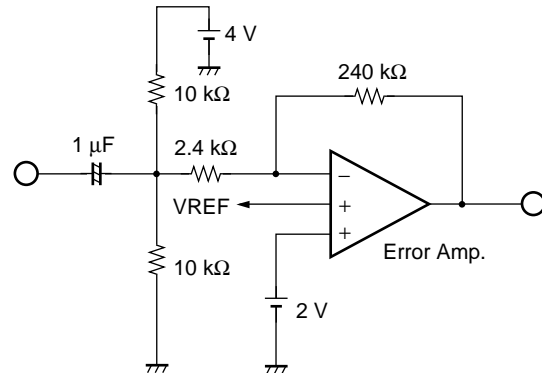
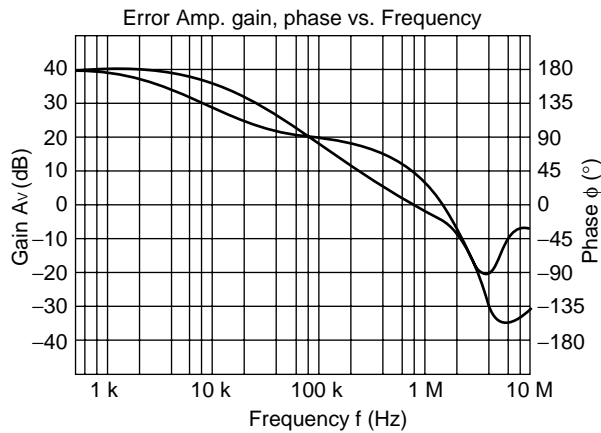
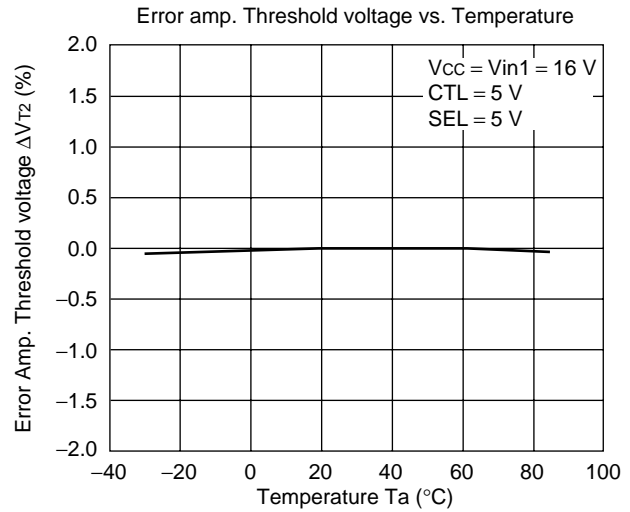
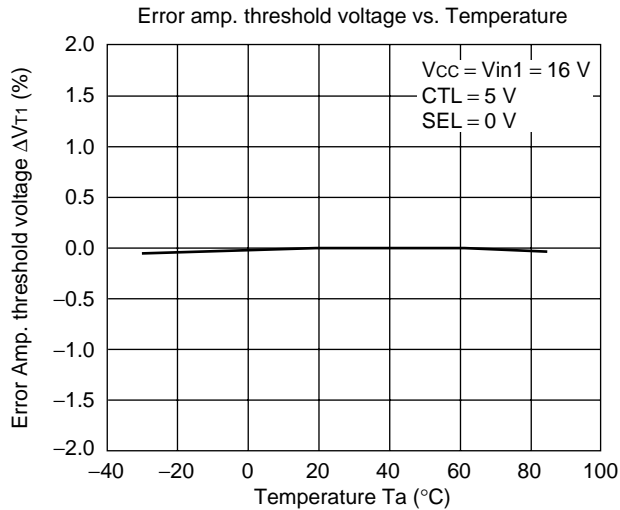

(Continued)

MB3813A/MB3833A/MB3843

(Continued)

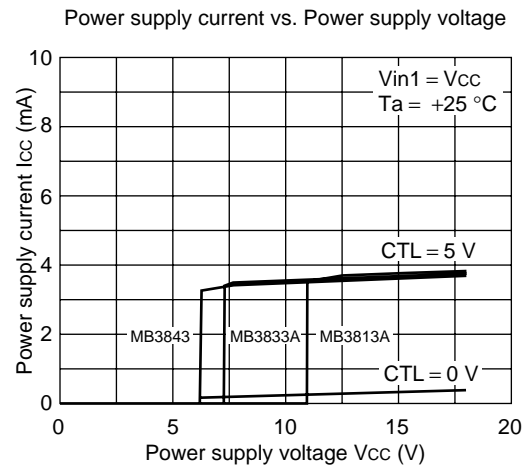
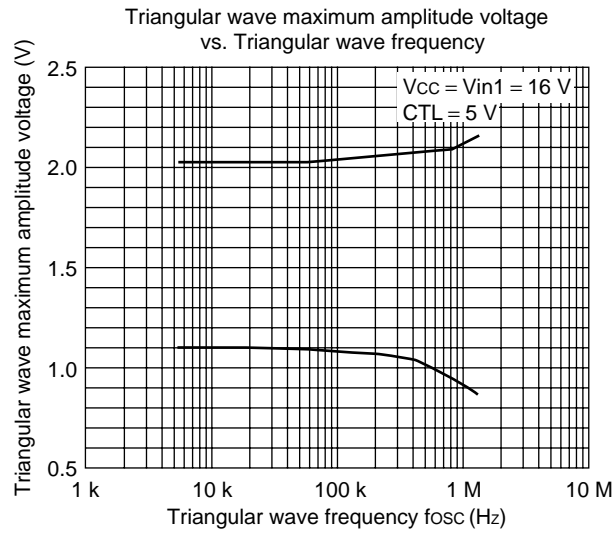
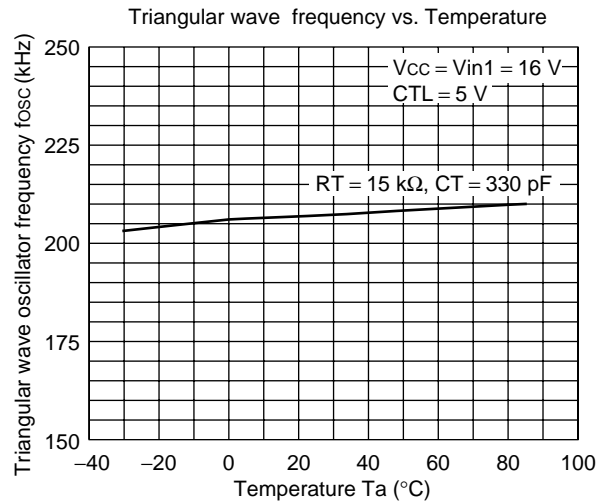
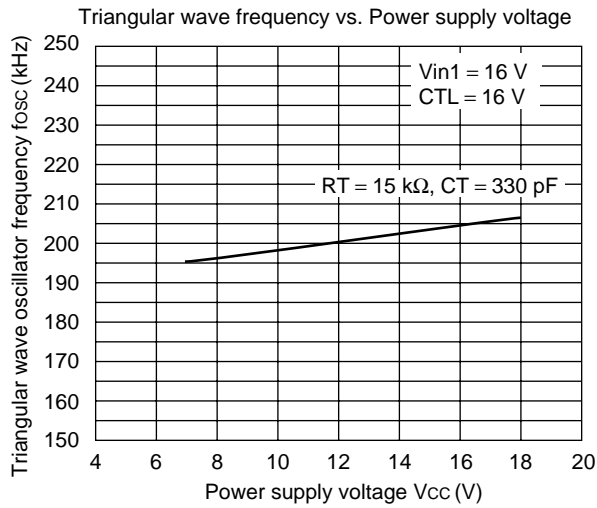

■ FUNCTIONAL DESCRIPTION

1. Switching Regulator Block

(1) Reference voltage circuit (Ref)

The reference voltage circuit uses the voltage supply from the V_{CC} terminal (pin 14) to generate a temperature compensated, stable voltage (≈ 2.50 V) for use as the reference voltage for the internal circuits of the IC chip.

It is also possible to supply a reference voltage output of up to 1 mA to external circuits through the VREF terminal (pin 9) .

(2) Triangular wave oscillator circuit (OSC)

By connecting the CT terminal (pin 13) and RT terminal (pin 12) respectively to a capacitance and resistance for timing, a triangular oscillator waveform can be generated.

The triangular wave is input to the PWM comparator circuits on the IC. At the same time, it can also be supplied to an external device from the CT terminal.

(3) Error amplifier circuit (Error Amp.1)

The error amplifier circuit is used to detect the output voltage from the switching regulator and produces the PWM control signal. No external resistance is required at the error amplifier inversion input terminal, because the output voltage setting resistance is connected within the IC. The output voltage settings are defined as : MB3813A 12.6 V/12.3 V, MB3833A 8.4 V/8.2 V, MB3843 4.2 V/4.1 V, the optimum levels respectively for use with 3-cell, 2-cell and 1-cell lithium-ion batteries.

Also, by connecting feedback resistance and capacitance between the error amplifier FB terminal (pin 6) and $-IN1$ terminal (pin 5) , it is possible to set the desired level of loop gain to provide stabilized phase compensation to the system.

The CS terminal (pin 11) can be connected to a soft-start capacitor to prevent current surges at startup. The soft-start is detected by the error amplifier, which provides a constant soft-start time independent of output load.

(4) Current detector amplifier circuit (Current Amp.)

The current detector amplifier provides $25 \times$ amplification of the voltage drop between the two ends of the output sensor resistor (RS) in the switching regulator, that occurs due to the flow of the charging current. This voltage drop is compared to the voltage at the Vin2 terminal (pin 8) in the next stage error amplifier circuit (Error Amp.2) , and used to control the charging current.

(5) Power supply control circuit (CTL)

An "L" level signal input to the CTL terminal (pin 7) places the IC in standby mode. In standby mode, all circuits other than input detection circuits are switched off.

(6) PWM comparator circuit (PMW Comp.)

This is a voltage-pulse width conversion circuit that controls the output duty of the error amplifier circuits (Error Amp.1, 2) according to the output voltage.

During intervals when the triangular waveform is lower than the error amplifier output voltage, an external output transistor is switched on.

(7) Output circuit (OUT)

The output circuit uses a totem-pole configuration and is capable of driving an external P-ch. MOS FET device.

MB3813A/MB3833A/MB3843

2. Output Voltage Switching Function

The SEL terminal (pin 10) is capable of output levels of 4.2 V or 4.1 V per battery cell.

• Output voltage settings by model

SEL terminal voltage level	Model	Output voltage	Units
L	MB3813A	12.6	V
H		12.3	V
L	MB3833A	8.4	V
H		8.2	V
L	MB3843	4.2	V
H		4.1	V

3. Protection Functions

(1) Input voltage detector circuit (VIDET)

When the input voltage supply from the AC adapter or other source detected at the Vin1 terminal (pin 1) falls below 11 V (MB3813A) , or below 7.3 V (MB3833A) , or below 6.3 V (MB3843) , the internal reference voltage circuit switches off.

(2) Under voltage lockout circuit (UVLO)

Power surges at power-on, or momentary under-voltage situations can cause abnormal operation in a control IC, which may lead to damage or deterioration in systems. This circuit prevents abnormal peration during times of low voltage by using the supply voltage to detect the level of the internal reference voltage, and switching off the external output transistor to create a 100% rest interval. Once the supply voltage recovers to a level above the threshold voltage of the under voltage lockout circuit, operation is restored.

■ METHOD OF SETTING THE CHARGING CURRENT

The charging current level (output limit current level) is set at the Vin2 terminal (pin 8) .

Charging current level (output limit current level) :

$$I_L (\text{Max.}) [\text{A}] = \frac{V_{in2} (\text{V})}{25 \times R_S (\Omega)} \quad R_S : \text{output sensing resistance}$$

■ METHOD OF SETTING THE SOFT-START TIME

- At start up, the capacitor (Cs) connected to the CS terminal (pin 11) begins charging. The error amplifier compares the soft-start setting voltage, which is proportional to the CS terminal voltage, to the output feedback voltage and produces a soft-start by varying the ON duty at the OUT terminal (pin 15) . The soft-start time can be determined by the formula below.
- Because the CS terminal voltage is input to the error amplifier, the soft-start time setting is not dependent on the output current value.

Soft-start time (time to output setting voltage VD) :

$$t_s [\text{s}] = 2.5 \times C_s [\mu\text{F}]$$

■ OSCILLATOR FREQUENCY SETTING

The oscillator frequency can be set by connecting a timing capacitor (C_T) to the CT terminal (pin 13) and a timing resistor (R_T) to the RT terminal (pin 12) .

Oscillator frequency : f_{osc}

$$f_{osc} (\text{kHz}) \cong \frac{990000}{C_T (\text{pF}) \bullet R_T (\text{k}\Omega)}$$

■ ERROR AMP. BLOCK OVERSHOOT PROTECTION CIRCUIT

This built-in circuit responds to rapid fluctuations in charging current such as can occur when inserting or removing a chargeable battery, by clamping an inverted input signal (–IN1 or –IN2) from the error amps (Error Amp.1 or Error Amp.2) to suppress changes in output voltage.

■ CTL, SEL TERMINAL EQUIVALENT CIRCUITS

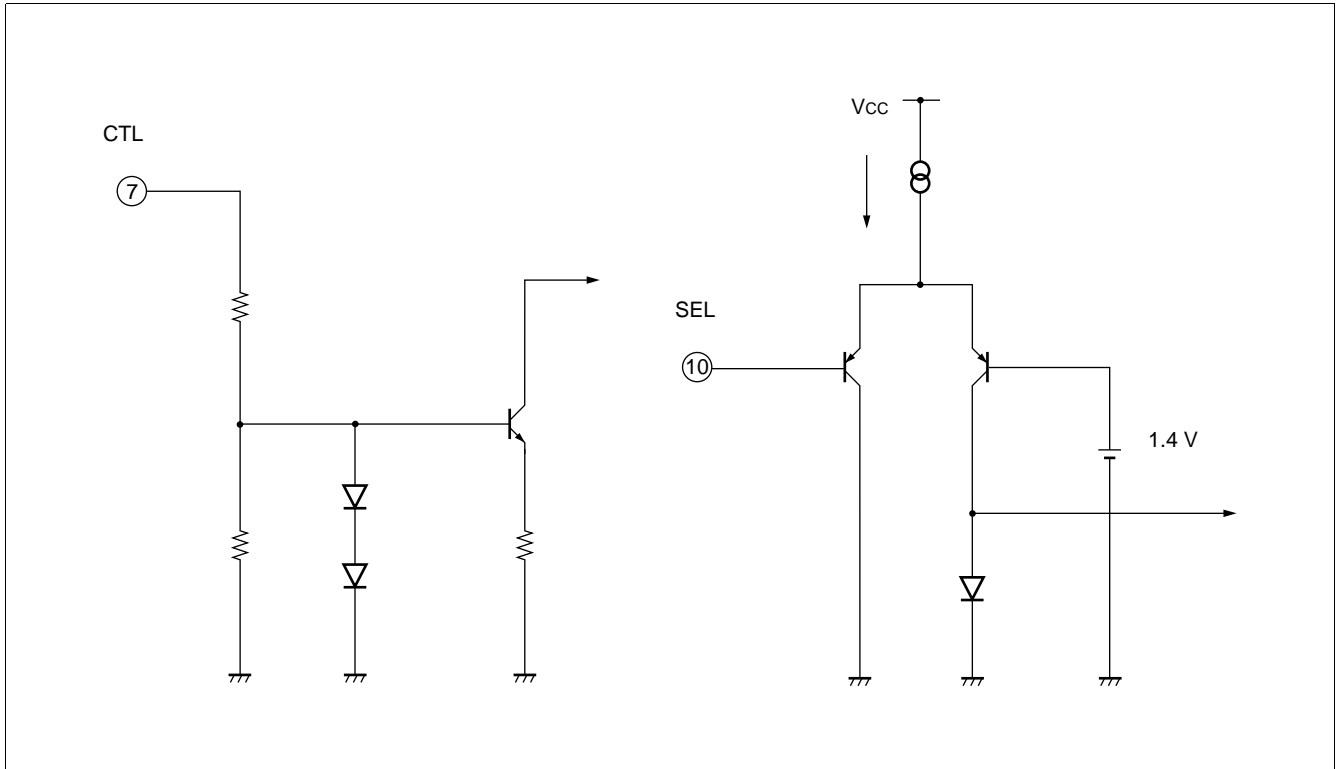

APPLICATION EXAMPLE

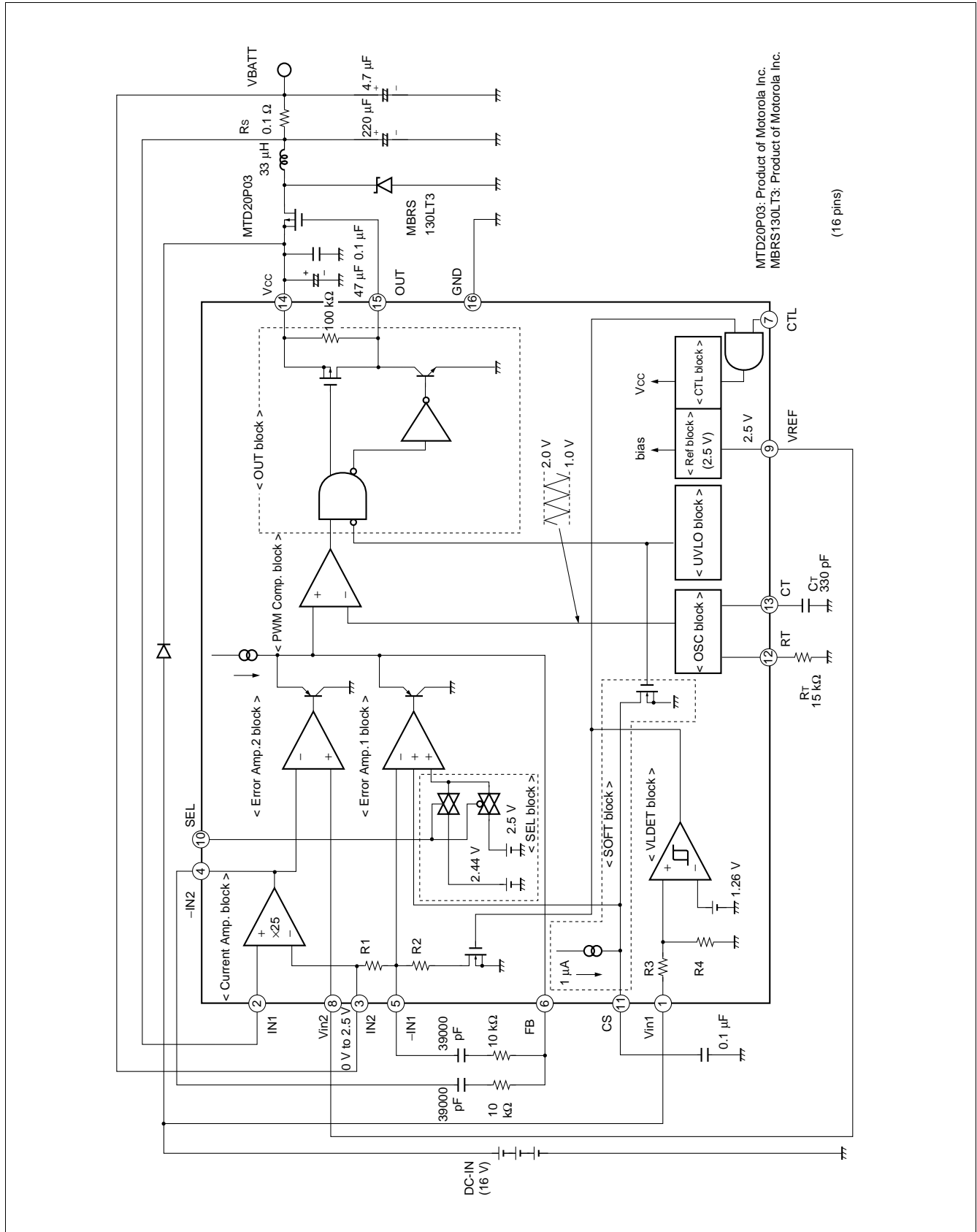

MB3813A/MB3833A/MB3843

■ REFERENCE DATA

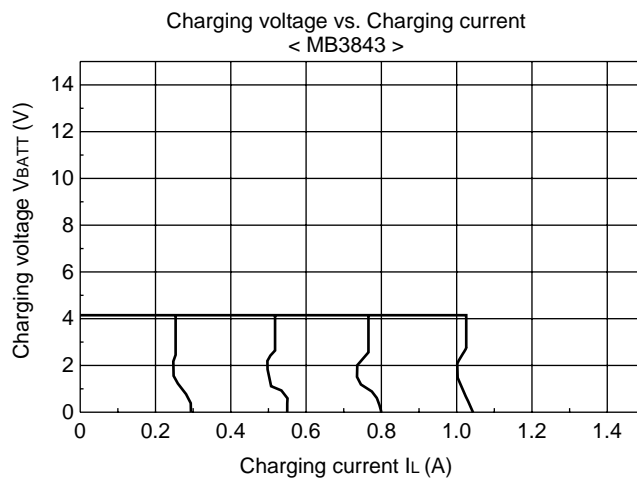
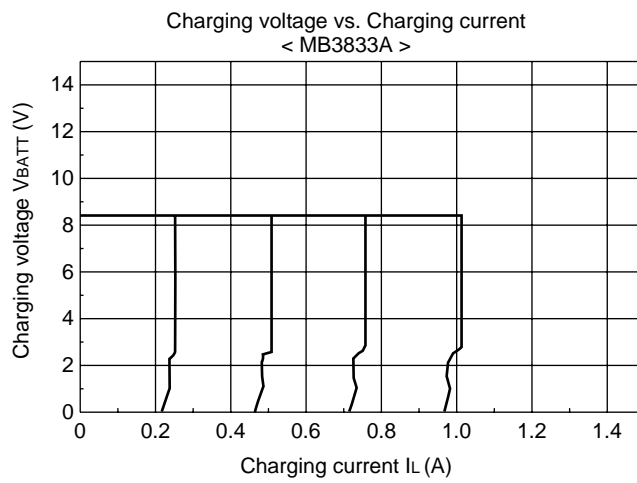
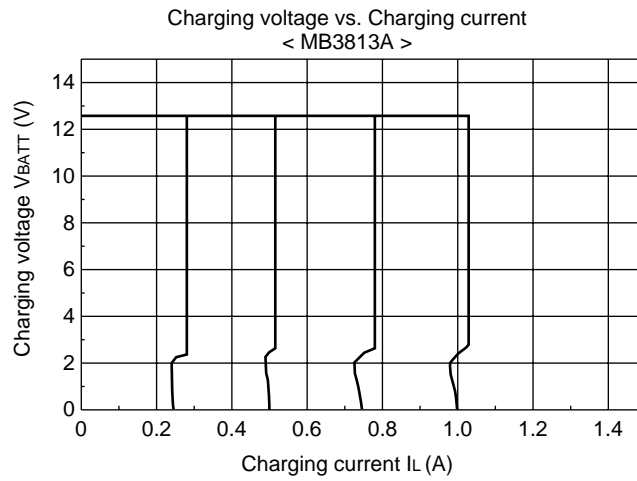

(Continued)

(Continued)

Soft-start operation waveforms

< MB3813A >

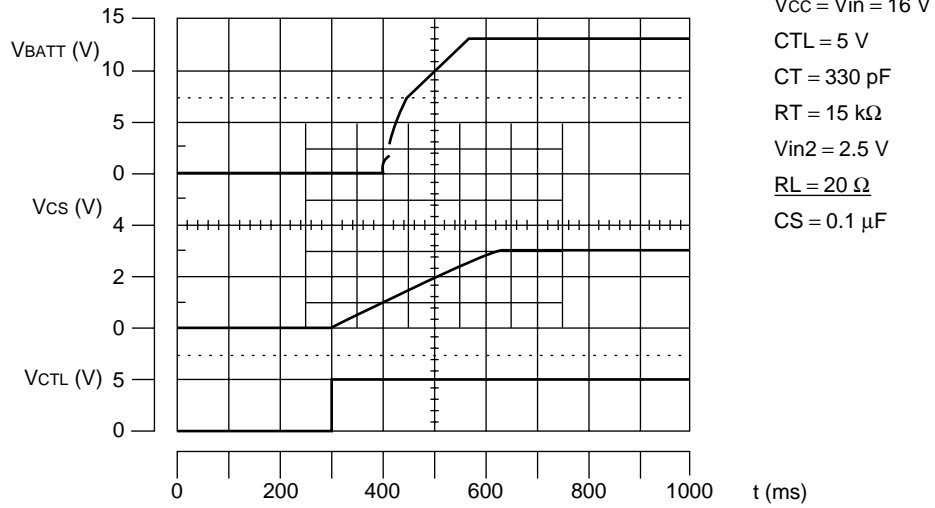

< MB3833A >

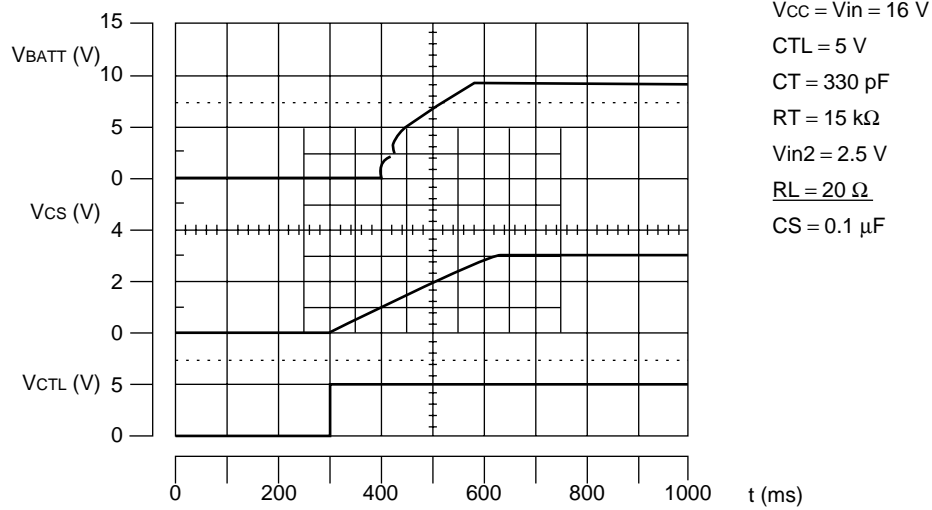

< MB3843 >

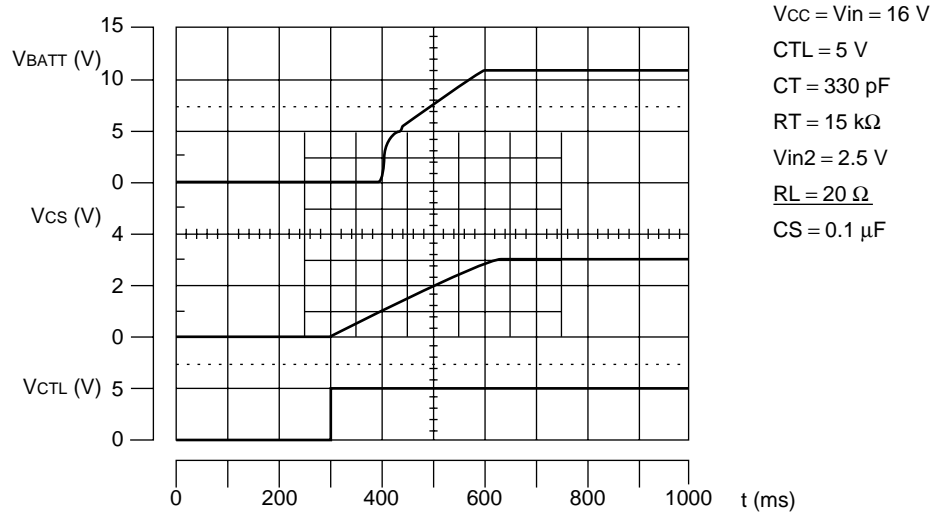

MB3813A/MB3833A/MB3843

■ USAGE PRECAUTION

- **Printed circuit board ground lines should be designed in consideration of common impedance values.**
- **Observe precautions against static electricity.**
- Containers in which semiconductors are placed should either be protected against static electricity, or be of conductive material.
- After devices are mounted, use conductive bags or conductive containers when storing or transporting printed circuit boards.
- Working surfaces, tools and instruments should be properly rounded.
- Workers should be grounded by a ground line with 250 k Ω to 1 M Ω resistance in series between the worker and ground.
- **Do not apply negative voltages.**

The use of negative voltages below -0.3 V may create parasitic transistors on LSI lines, which can cause abnormal operation.

■ ORDERING INFORMATION

Part number	Package	Remarks
MB3813APFV MB3833APFV MB3843PFV	16-pin plastic SSOP (FPT-16P-M05)	

MB3813A/MB3833A/MB3843

■ PACKAGE DIMENSION

16-pin plastic SSOP
(FPT-16P-M05)

Note 1) * : These dimensions do not include resin protrusion.

Note 2) Pins width and pins thickness include plating thickness.

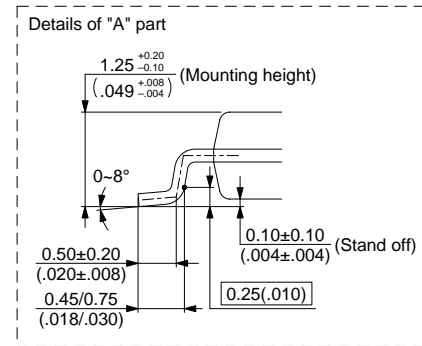
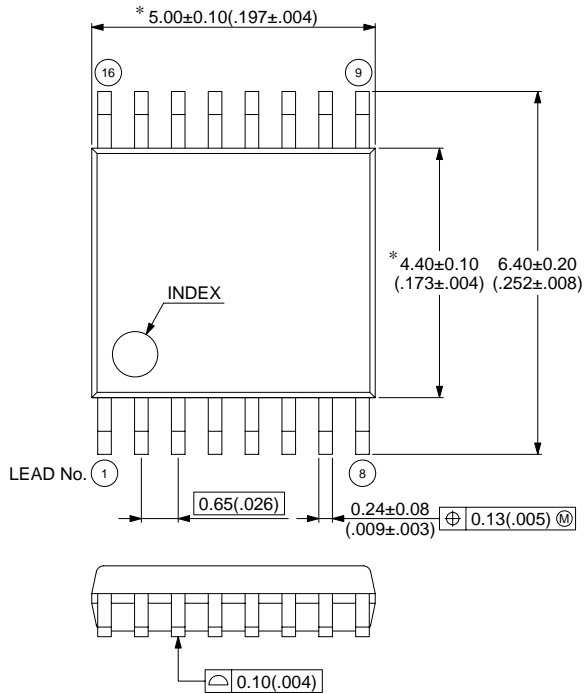

© 1999 FUJITSU LIMITED F16013S-3C-5

Dimensions in mm (inches)

FUJITSU LIMITED

All Rights Reserved.

The contents of this document are subject to change without notice. Customers are advised to consult with FUJITSU sales representatives before ordering.

The information and circuit diagrams in this document are presented as examples of semiconductor device applications, and are not intended to be incorporated in devices for actual use. Also, FUJITSU is unable to assume responsibility for infringement of any patent rights or other rights of third parties arising from the use of this information or circuit diagrams.

The products described in this document are designed, developed and manufactured as contemplated for general use, including without limitation, ordinary industrial use, general office use, personal use, and household use, but are not designed, developed and manufactured as contemplated (1) for use accompanying fatal risks or dangers that, unless extremely high safety is secured, could have a serious effect to the public, and could lead directly to death, personal injury, severe physical damage or other loss (i.e., nuclear reaction control in nuclear facility, aircraft flight control, air traffic control, mass transport control, medical life support system, missile launch control in weapon system), or (2) for use requiring extremely high reliability (i.e., submersible repeater and artificial satellite).

Please note that Fujitsu will not be liable against you and/or any third party for any claims or damages arising in connection with above-mentioned uses of the products.

Any semiconductor devices have an inherent chance of failure. You must protect against injury, damage or loss from such failures by incorporating safety design measures into your facility and equipment such as redundancy, fire protection, and prevention of over-current levels and other abnormal operating conditions.

If any products described in this document represent goods or technologies subject to certain restrictions on export under the Foreign Exchange and Foreign Trade Law of Japan, the prior authorization by Japanese government will be required for export of those products from Japan.

F0209
© FUJITSU LIMITED Printed in Japan