

KA278RXXC-Series

2A Output Low Dropout Voltage Regulators

Features

KA278RXXC-series (33/05/51/09/12)

- 2A/3.3V, 5V, 5.1V, 9V, 12V output low dropout voltage regulator
- TO-220 full-mold package (4pin)
- Overcurrent protection, thermal shutdown
- Overvoltage protection, short circuit protection
- With output disable function

KA278RA05C

- Nominal 5V output without adjusting
- Output adjustable between 1.25V and 32V
- 2A output low dropout voltage regulator
- TO-220 full-mold package (4pin)
- Overcurrent protection, thermal shutdown
- Overvoltage protection, short circuit protection

Description

The KA278RXXC is a low-dropout voltage regulator suitable for various electronic equipments. It provides constant voltage power source with TO-220-4 lead full mold package. The dropout voltage of KA278RXXC is below 0.5V in full rated current(2A). This regulator has various functions such as a peak current protection, a thermal shut down, an overvoltage protection .

TO-220F-4L



1.Vin 2. Vo 3. GND 4. Vdis - KA278RXXC(33/05/51/09/12)
1.Vin 2. Vo 3. GND 4. Vadj - KA278RA05C

Internal Block Diagram

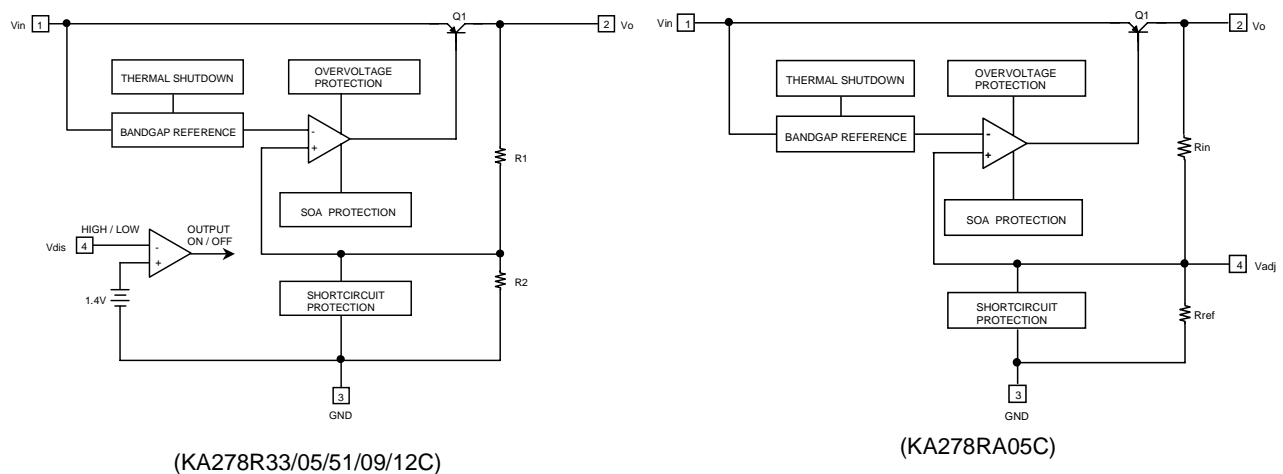

Absolute Maximum Ratings

KA278RXXC, KA278RA05C

Parameter	Symbol	Value	Unit	Remark
Input voltage	V _{in}	35	V	-
Disable voltage	KA278RXXC V _{dis}	35	V	-
Output current	I _o	2.0	A	-
Power dissipation 1	P _{d1}	1.5	W	No heatsink
Power dissipation 2	P _{d2}	15	W	With heatsink
Junction temperature	T _j	150	°C	-
Operating temperature	T _{opr}	-20 ~ 80	°C	-
Thermal resistance, junction-to case (note2)	R _{θjc}	2.9	°C/W	-
Thermal resistance, junction-to-air (note2)	R _{θja}	48.51	°C/W	-

Electrical Characteristics

(V_{in} =Note3, I_o =1.0A, T_a =25°C , unless otherwise specified)

Parameter		Symbol	Conditions	Min.	Typ.	Max.	Unit
Output voltage	KA278R33C	Vo	-	3.22	3.3	3.38	V
	KA278R05C		-	4.88	5	5.12	
	KA278R51C		-	4.98	5.1	5.22	
	KA278R09C		-	8.78	9	9.22	
	KA278R12C		-	11.7	12	12.3	
Load regulation		Rload	5mA < I_o < 2A	-	0.1	2.0	%
Line regulation		Rline	Note4	-	0.5	2.5	%
Ripple rejection ratio		RR	Note1	45	55	-	dB
Dropout voltage		Vdrop	$I_o = 2A$	-	-	0.5	V
Disable voltage high	KA278RXXC	VdisH	Output active	2.0	-	-	V
Disable voltage low	KA278RXXC	VdisL	Output disabled	-	-	0.8	V
Disable bias current high	KA278RXXC	IdisH	Vdis = 2.7V	-	-	20	μA
Disable bias current low	KA278RXXC	IdisL	Vdis = 0.4V	-	-	-0.4	mA
Quiescent current		Iq	$I_o = 0A$	-	-	10	mA
Reference voltage	KA278RA05C	Vref	-	1.24	1.27	1.30	V

Note:

- These parameters, although guaranteed, are not 100% tested in production.
- Junction -to -case thermal resistance test environments.
 - Pneumatic heat sink fixture.
 - Clamping pressure 60psi through 12mm diameter cylinder.
 - Thermal grease applied between PKG and heat sink fixture.
- KA278R33C : $V_{in} = 5V$
 KA278R05C : $V_{in} = 7V$
 KA278R09C : $V_{in} = 11V$
 KA278R12C : $V_{in} = 15V$
- KA278R33C : $V_{in} = 4$ to 10V
 KA278R05C, KA278R51C : $V_{in} = 6$ to 12V
 KA278R09C : $V_{in} = 10$ to 25V
 KA278R12C : $V_{in} = 13V$ to 29V

Typical Performance Characteristics

KA278R33C

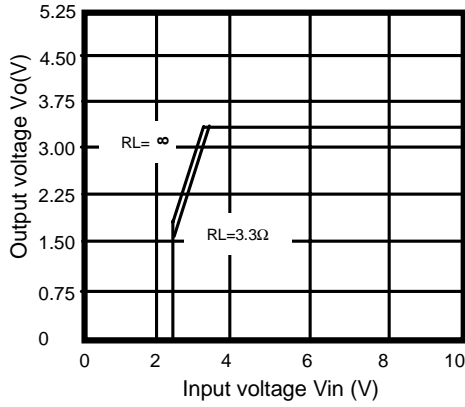

Figure 1. Output Voltage vs. Input Voltage

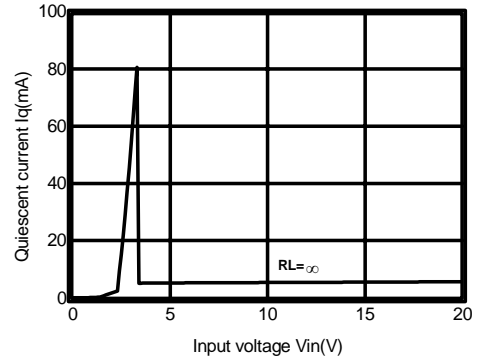

Figure 2. Quiescent Current vs. Input Voltage

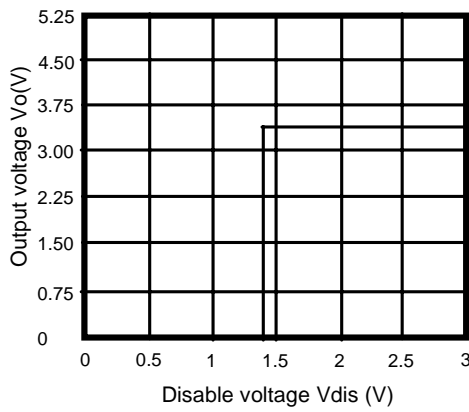

Figure 3. Output Voltage vs. Disable Voltage

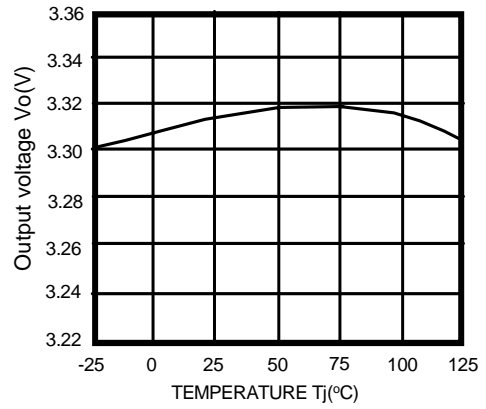

Figure 4. Output Voltage vs. Temperature(Tj)

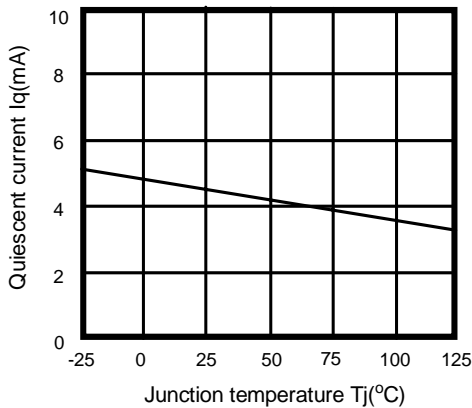

Figure 5. Quiescent Current vs. Temperature(Tj)

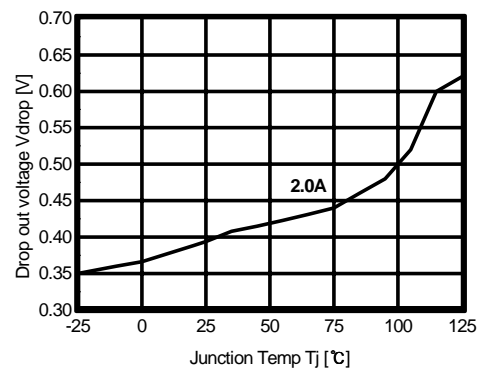

Figure 6. Dropout Voltage vs. Junction Temperature

Typical Performance Characteristics (Continued)

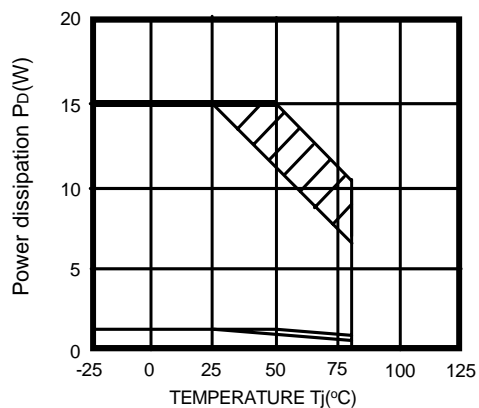

Figure 7. Power Dissipation vs. Temperature(Tj)

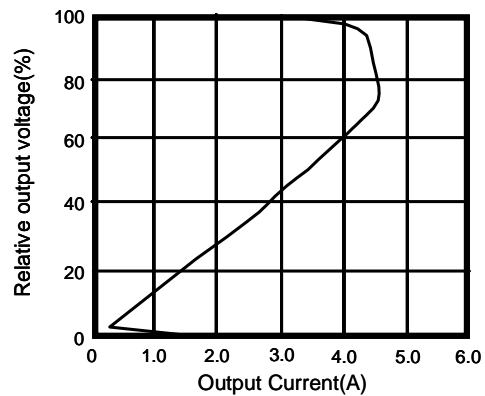

Figure 8. Overcurrent Protection Characteristics (Typical Value)

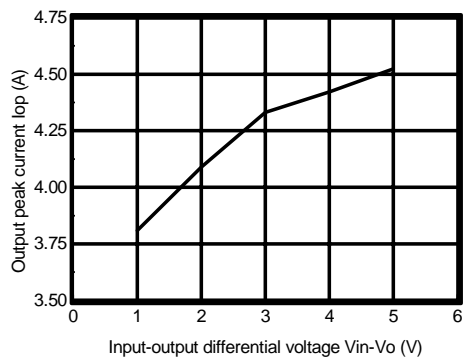

Figure 9. Output Peak Current vs. Input-Output Differential Voltage

Typical Performance Characteristics(Continued)

KA278R05C

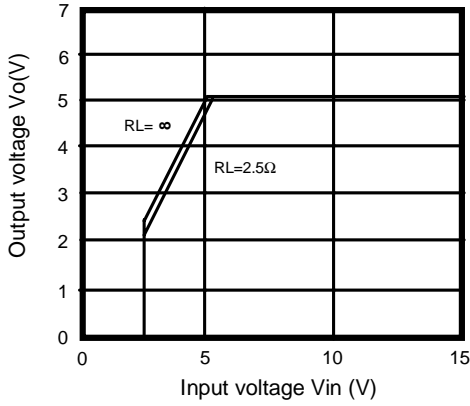

Figure 1. Output Voltage vs. Input Voltage

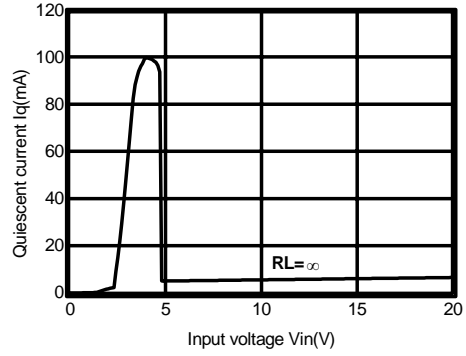

Figure 2. Quiescent Current vs. Input Voltage

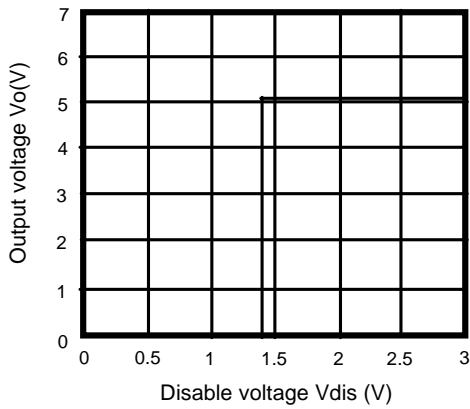

Figure 3. Output Voltage vs. Disable Voltage

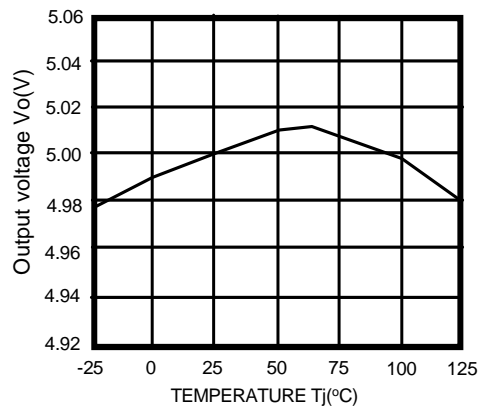

Figure 4. Output Voltage vs. Temperature(Tj)

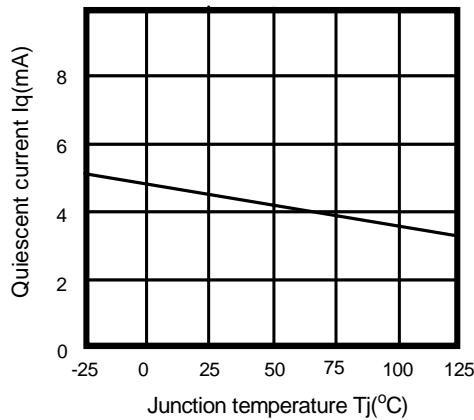

Figure 5. Quiescent Current vs. Temperature(Tj)

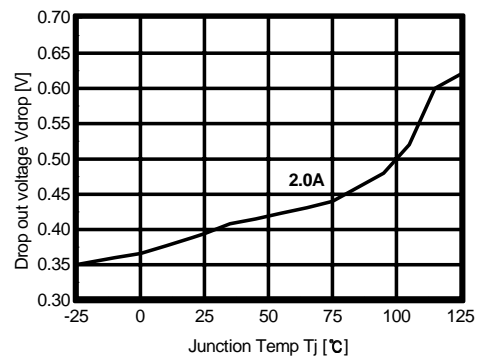

Figure 6. Dropout Voltage vs. Junction Temperature

Typical Performance Characteristics (Continued)

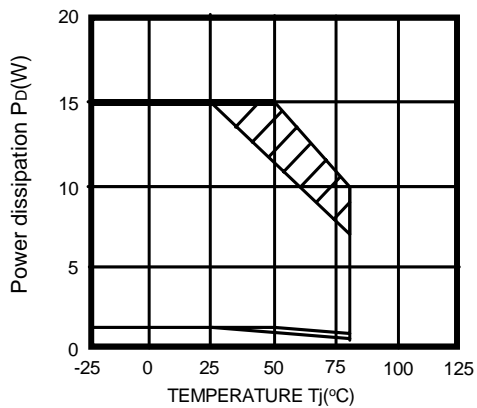

Figure 7. Power Dissipation vs. Temperature(Tj)

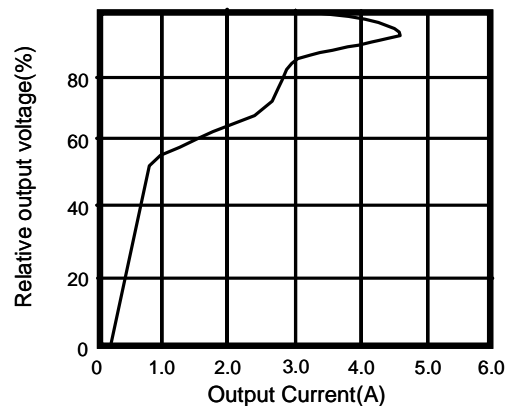

Figure 8. Overcurrent Protection Characteristics (Typical Value)

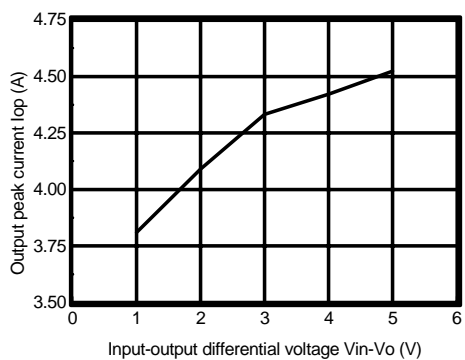

Figure 9. Output Peak Current vs. Input-Output Differential Voltage

Typical Performance Characteristics (Continued)

KA278R51C

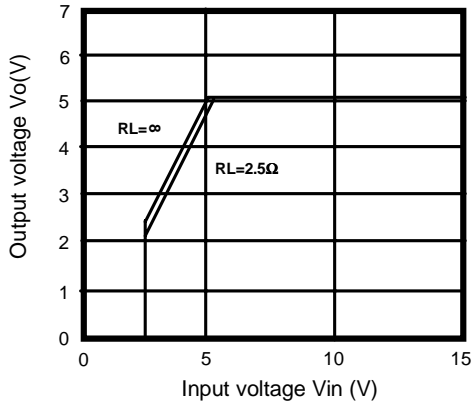

Figure 1. Output Voltage vs. Input Voltage

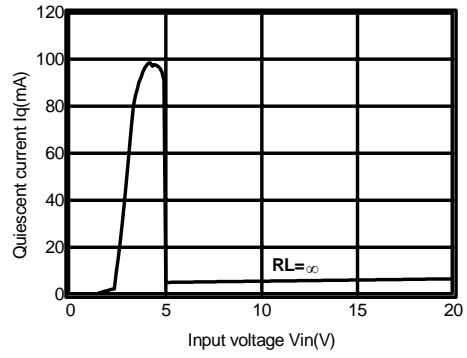

Figure 2. Quiescent Current vs. Input Voltage

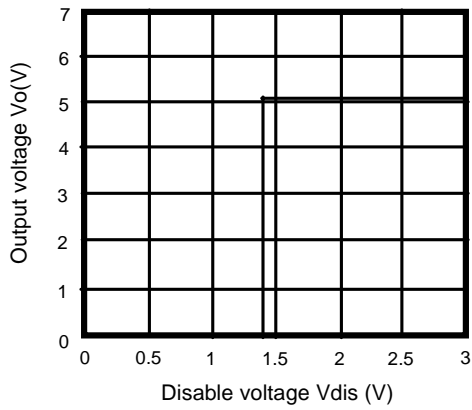

Figure 3. Output Voltage vs. Disable Voltage

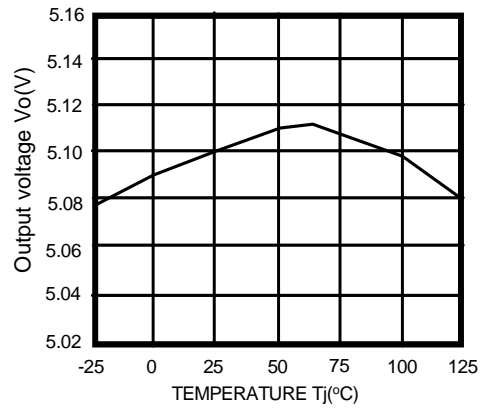

Figure 4. Output Voltage vs. Temperature(Tj)

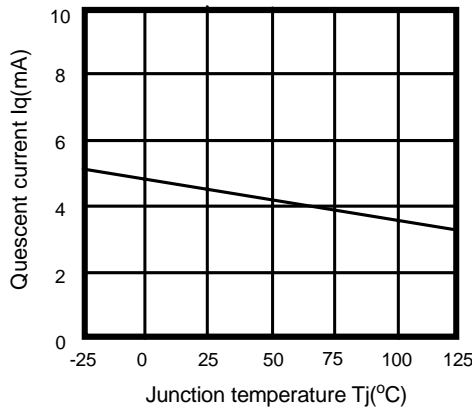

Figure 5. Quiescent Current vs. Temperature(Tj)

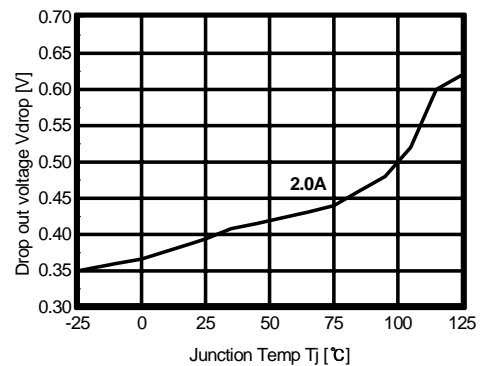

Figure 6. Dropout Voltage vs. Junction Temperature

Typical Performance Characteristics (Continued)

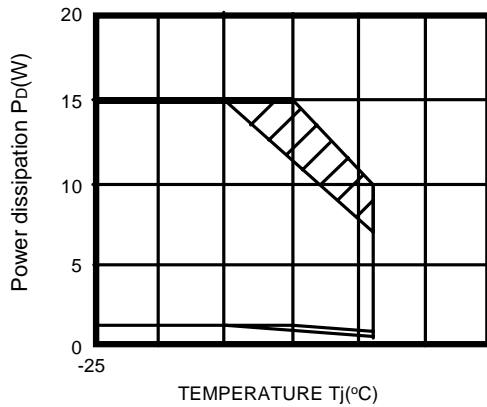

Figure 7. Power Dissipation vs. Temperature(Tj)

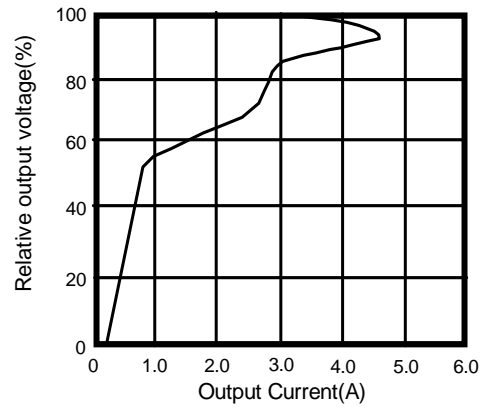

Figure 8. Overcurrent Protection Characteristics (Typical value)

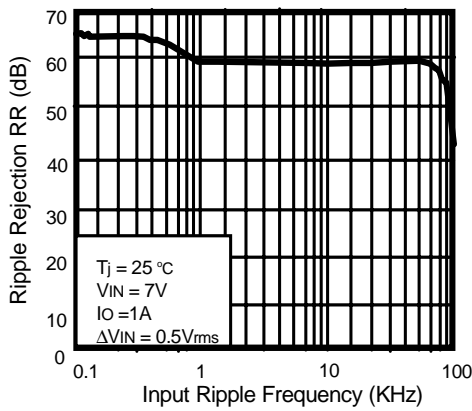

Figure 9. Ripple Rejection vs. Input Ripple Frequency

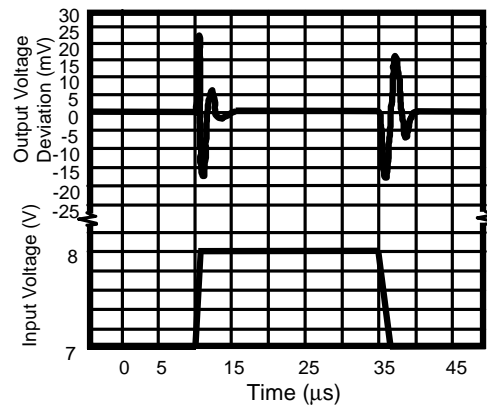

Figure 10. Line Transient Response

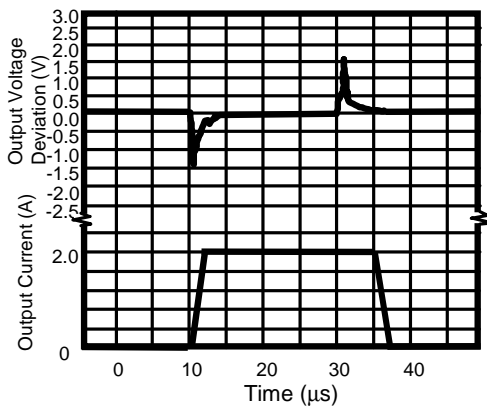

Figure 11. Load Transient Response

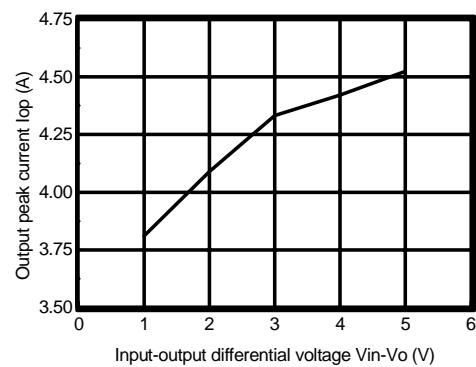

Figure 12. Output Peak Current vs. Input-Output Differential Voltage

Typical Performance Characteristics (Continued)

KA278R09C

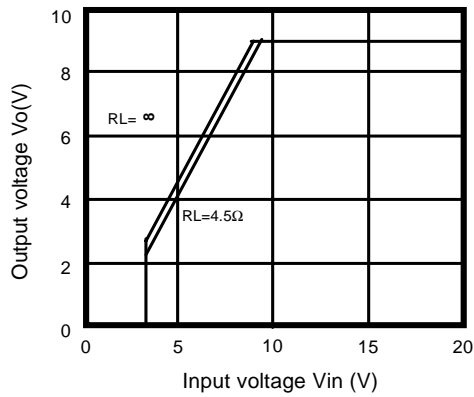

Figure 1. Output Voltage vs. Input Voltage

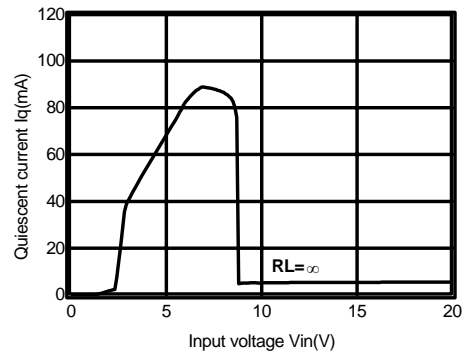

Figure 2. Quiescent Current vs. Input Voltage

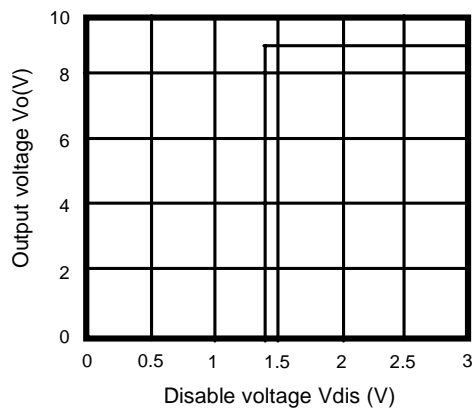

Figure 3. Output Voltage vs. Disable Voltage

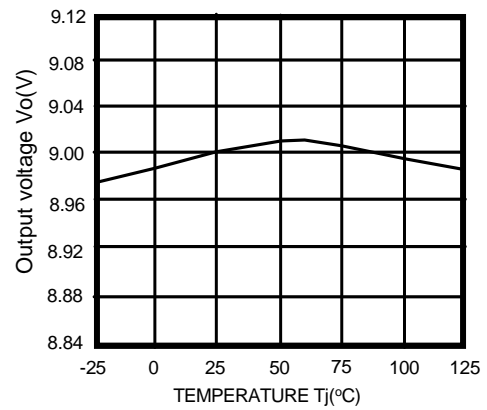

Figure 4. Output Voltage vs. Temperature(T_j)

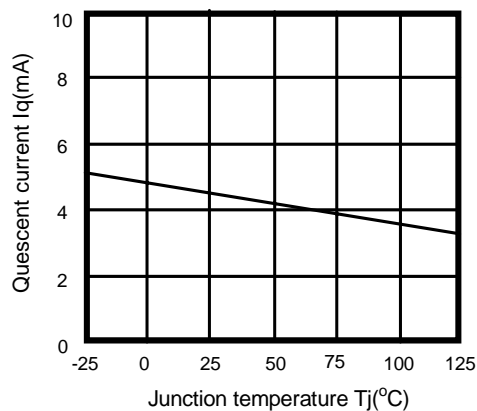

Figure 5. Quiescent Current vs. Temperature(T_j)

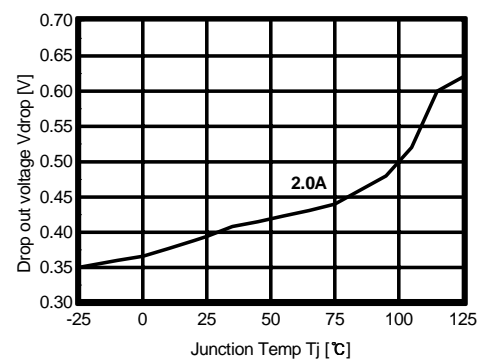

Figure 6. Dropout Voltage vs. Junction Temperature

Typical Performance Characteristics (Continued)

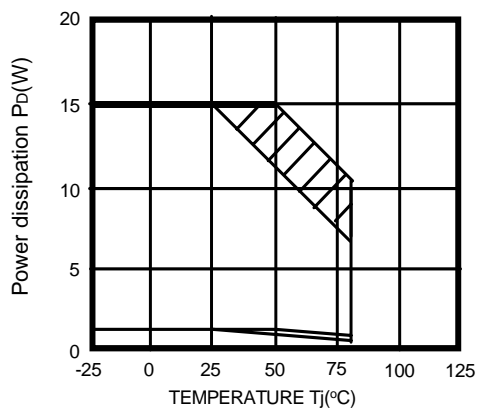

Figure 7. Power Dissipation vs. Temperature(T_j)

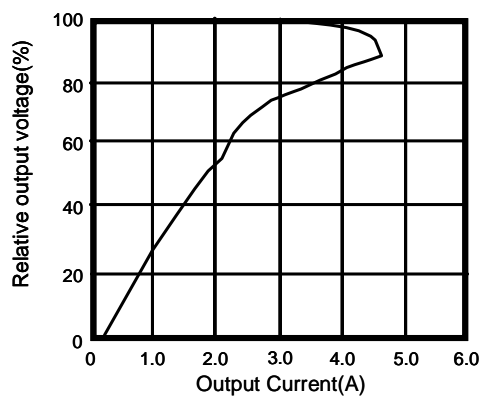

Figure 8. Overcurrent Protection Characteristics (Typical Value)

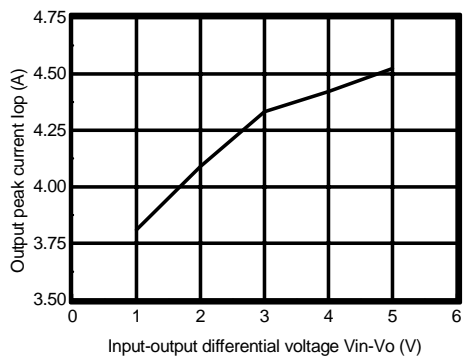

Figure 9. Output Peak Current vs. Input-Output Differential Voltage

Typical Performance Characteristics (Continued)

KA278R12C

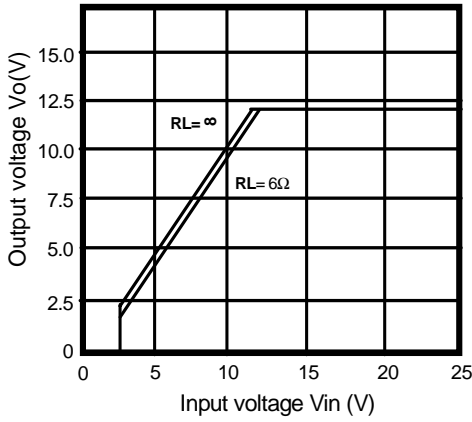

Figure 1. Output Voltage vs. Input Voltage

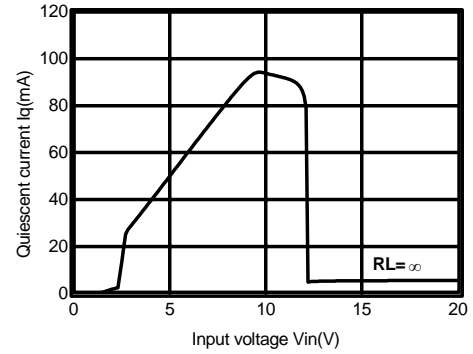

Figure 2. Quiescent Current vs. Input Voltage

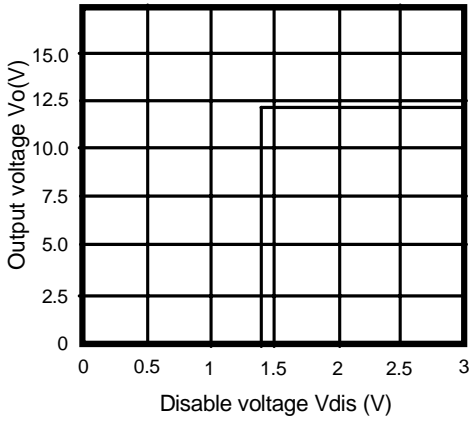

Figure 3. Output Voltage vs. Disable Voltage

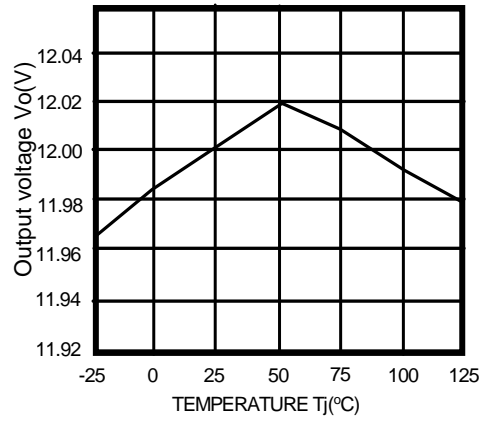

Figure 4. Output Voltage vs. Temperature(Tj)

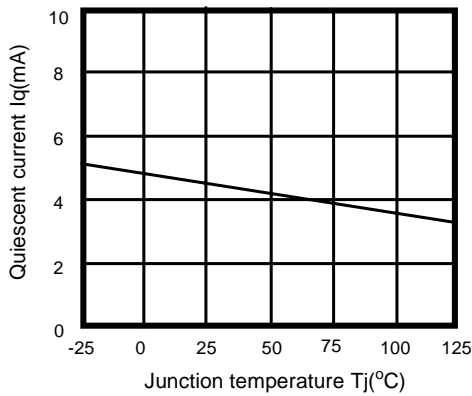

Figure 5. Quiescent Current vs. Temperature(Tj)

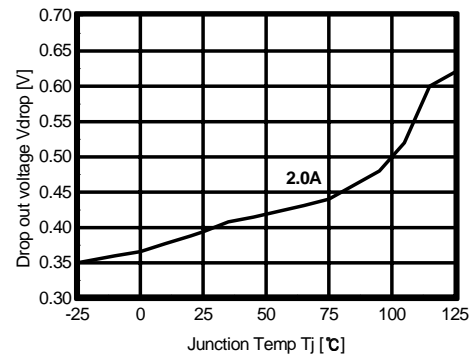

Figure 6. Dropout Voltage vs. Junction Temperature

Typical Performance Characteristics (Continued)

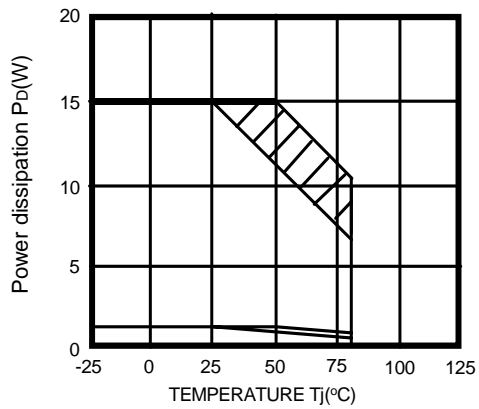

Figure 7. Power Dissipation vs. Temperature(T_j)

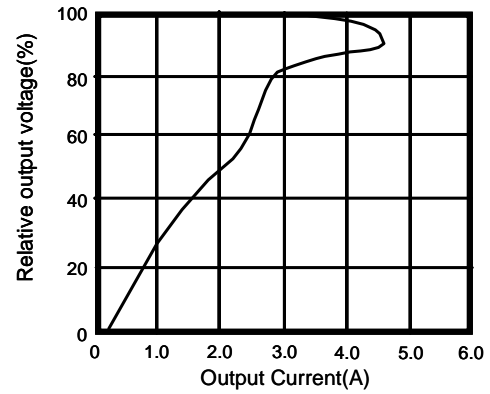

Figure 8. Overcurrent Protection Characteristics (Typical Value)

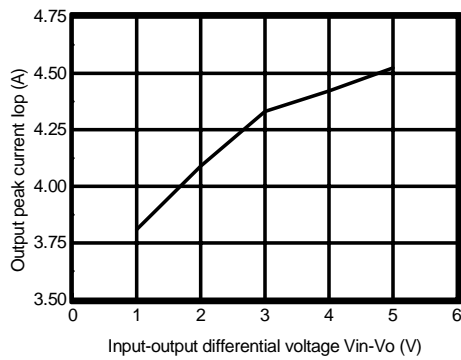

Figure 9. Output Peak Current vs. Input-Output Differential Voltage

Typical Performance Characteristics (Continued)

KA278RA05C

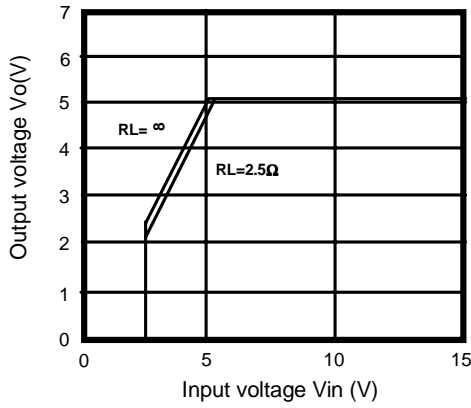

Figure 1. Output Voltage vs. Input Voltage

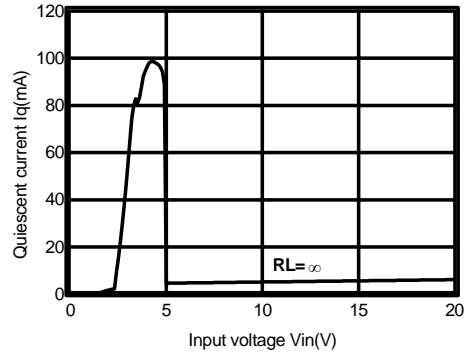

Figure 2. Quiescent Current vs. Input Voltage

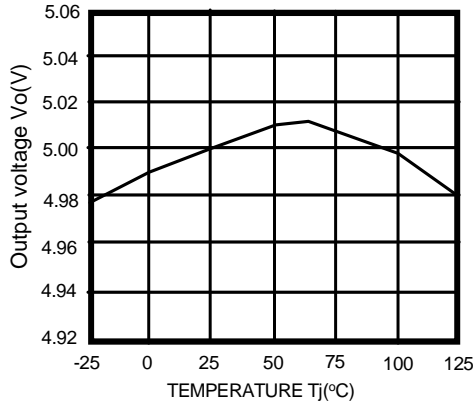

Figure 3. Output Voltage vs. Temperature(Tj)
* Fixed Mode (Vo=5V)

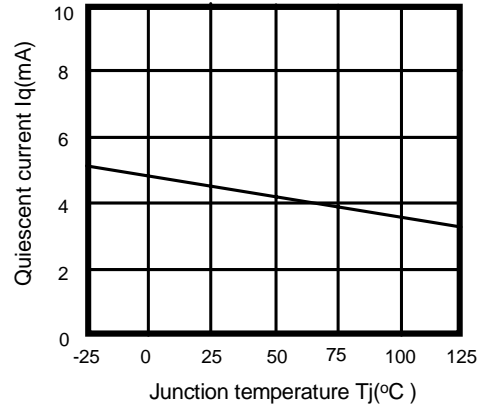

Figure 4. Quiescent Current vs. Temperature(Tj)

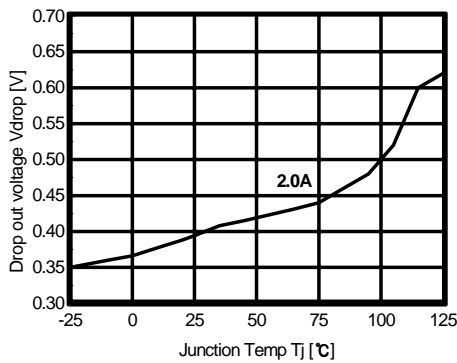

Figure 5. Dropout Voltage vs. Junction Temperature

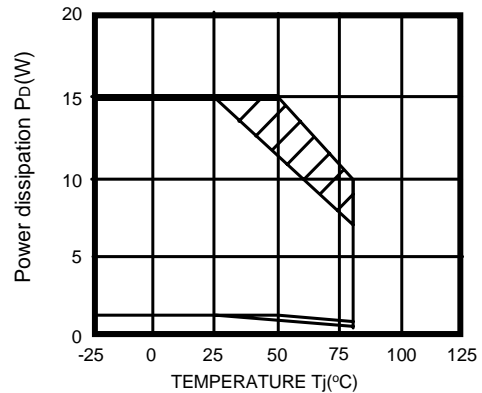

Figure 6. Power Dissipation vs. Temperature(Tj)

Typical Performance Characteristics (Continued)

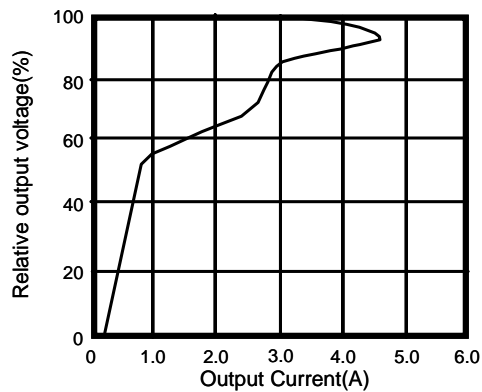

Figure 7. Overcurrent Protection Characteristics(Typical value)

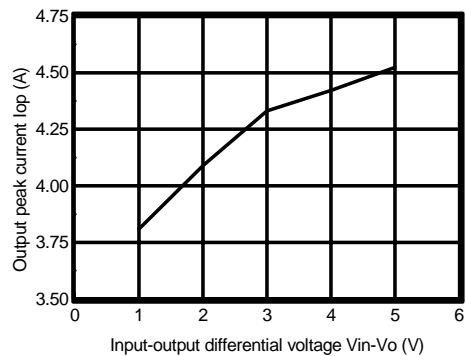

Figure 8. Output Peak Current vs. Input-Output Differential Voltage

Typical Application

KA278R33/05/51/09/12C

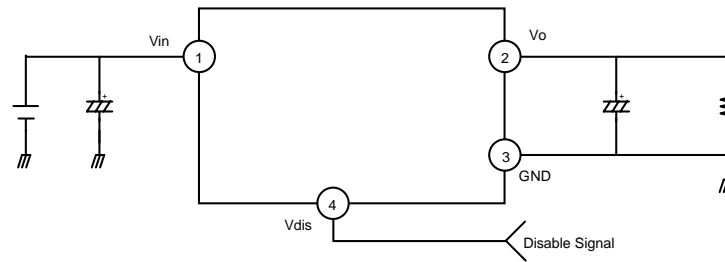
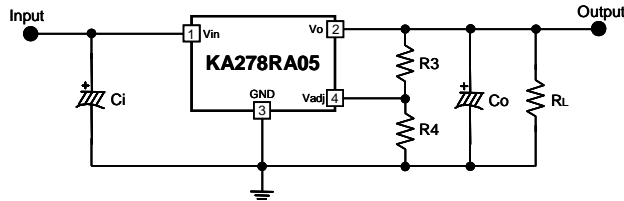

Figure 1. Application Circuit

- Ci is required if regulator is located at an appreciable distance from power supply filter.
- Co improves stability and transient response. (Co > 47µF)

KA278RA05



$$V_o = 1.25 \left(1 + \frac{R_1//R_3}{R_2//R_4} \right) \quad R_1 = 1.8k\Omega, R_2 = 0.6k\Omega$$

Figure 2. Application Circuit (Adjustable Mode)

- Ci is required if regulator is located at an appreciable distance from power supply filter.
- Co improves stability and transient response. (Co > 47µF)

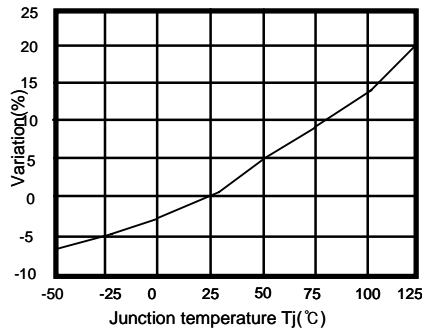

Figure 3. Internal Resistor(R1,R2) Variation vs. Temperature(Tj)

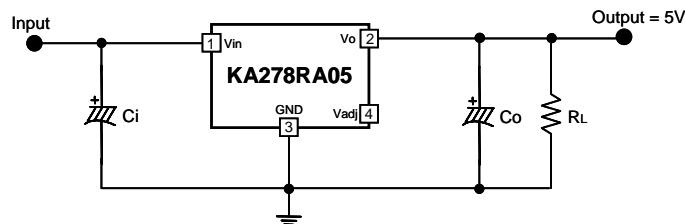

Figure 4. Application Circuit (Fixed Mode)

Mechanical Dimensions

Package

Dimensions in millimeters

TO-220F-4L

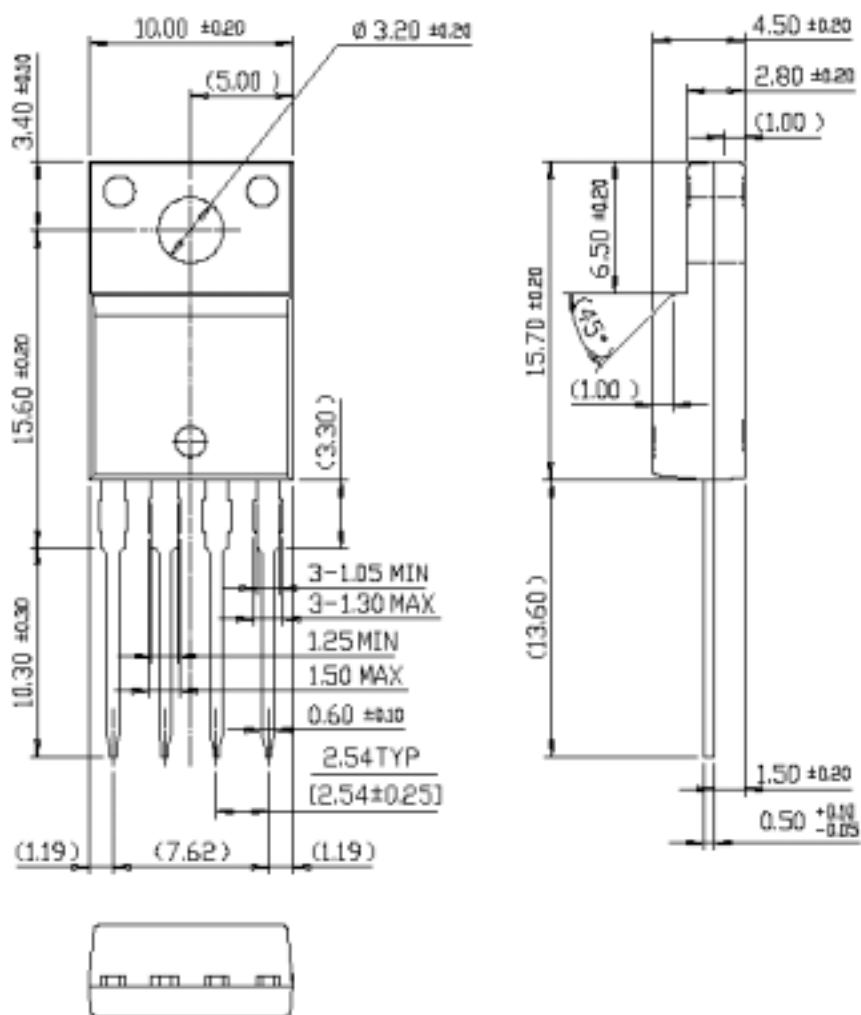

Mechanical Dimensions (Continued)

Package

Dimensions in millimeters

TO-220F-4L(Forming)

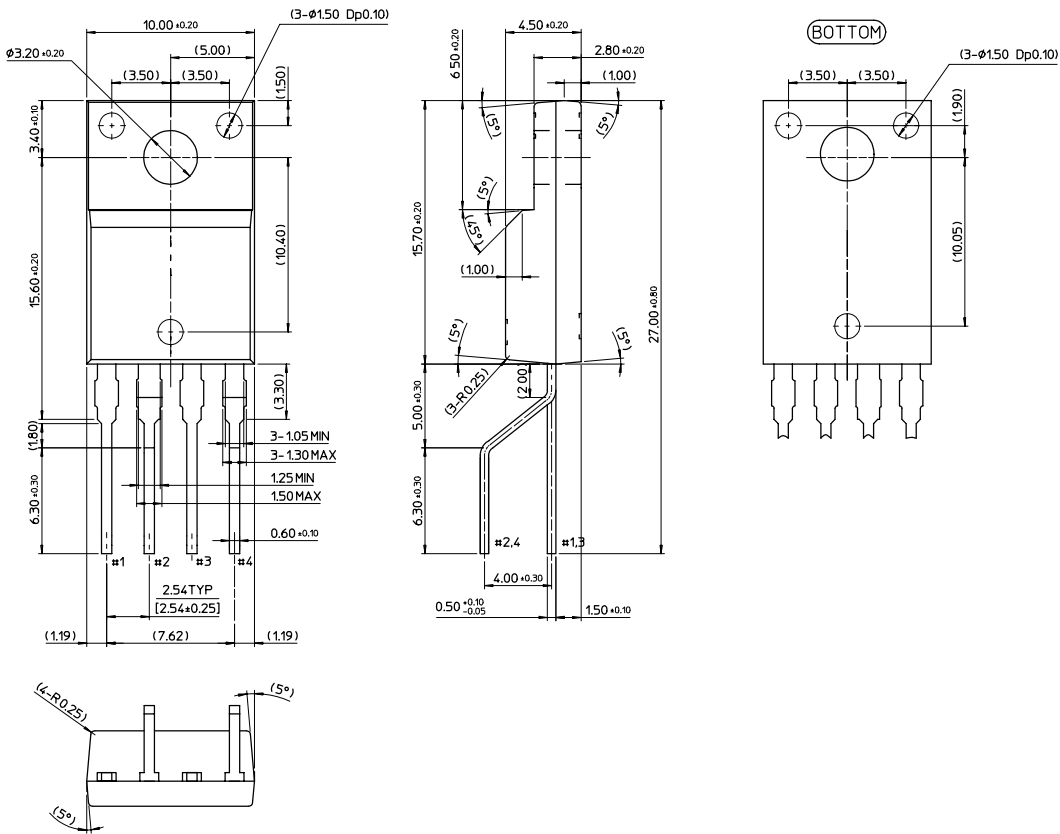

Mechanical Dimensions (Continued)

Package

Dimensions in millimeters

TO-220F-4L(Short Lead)

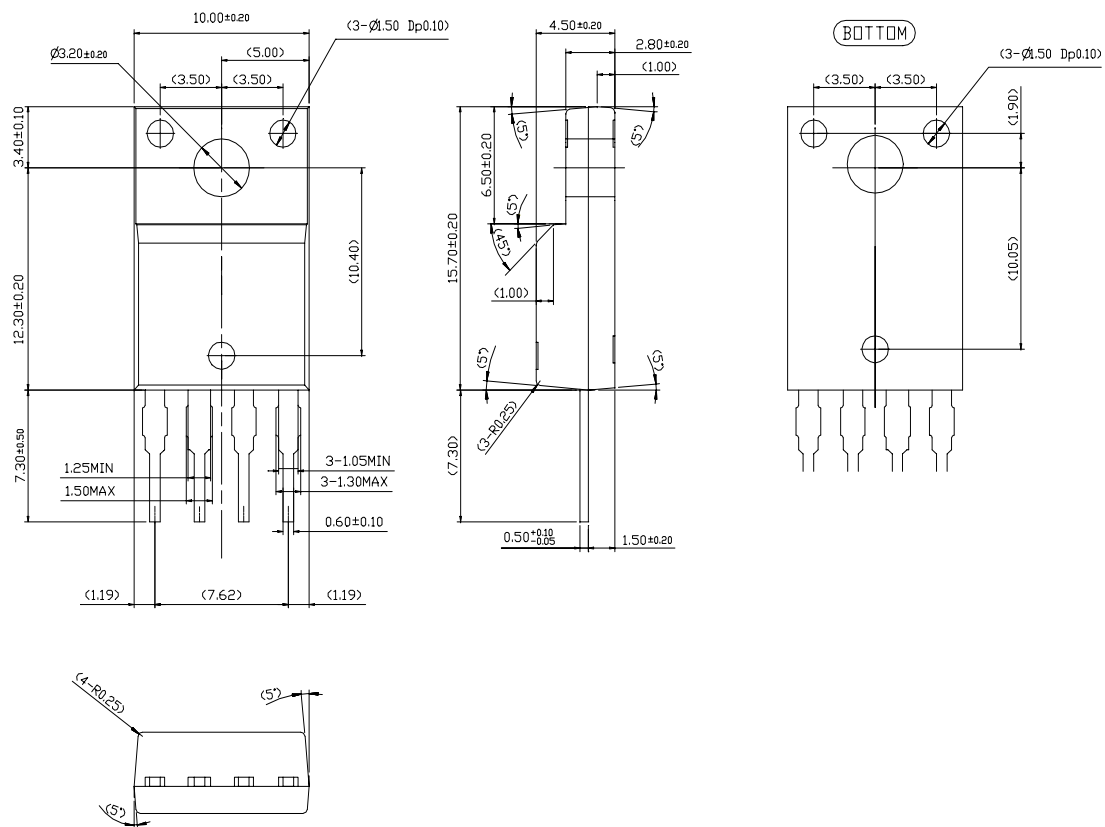

Ordering Information

Product Number	Package	Operating Temperature
KA278R33CTU	TO-220F-4L	-20°C to +80°C
KA278R05CTU		
KA278R51CTU		
KA278R09CTU		
KA278R12CTU		
KA278RA05CTU		
KA278R33CYDTU	TO-220F-4L(Forming)	
KA278R05CYDTU		
KA278R09CYDTU		
KA278R12CYDTU		
KA278RA05CYDTU		
KA278R33CTSTU	TO-220F-4L(Short Lead)	
KA278R05CTSTU		
KA278R12CTSTU		

DISCLAIMER

FAIRCHILD SEMICONDUCTOR RESERVES THE RIGHT TO MAKE CHANGES WITHOUT FURTHER NOTICE TO ANY PRODUCTS HEREIN TO IMPROVE RELIABILITY, FUNCTION OR DESIGN. FAIRCHILD DOES NOT ASSUME ANY LIABILITY ARISING OUT OF THE APPLICATION OR USE OF ANY PRODUCT OR CIRCUIT DESCRIBED HEREIN; NEITHER DOES IT CONVEY ANY LICENSE UNDER ITS PATENT RIGHTS, NOR THE RIGHTS OF OTHERS.

LIFE SUPPORT POLICY

FAIRCHILD'S PRODUCTS ARE NOT AUTHORIZED FOR USE AS CRITICAL COMPONENTS IN LIFE SUPPORT DEVICES OR SYSTEMS WITHOUT THE EXPRESS WRITTEN APPROVAL OF THE PRESIDENT OF FAIRCHILD SEMICONDUCTOR CORPORATION. As used herein:

1. Life support devices or systems are devices or systems which, (a) are intended for surgical implant into the body, or (b) support or sustain life, and (c) whose failure to perform when properly used in accordance with instructions for use provided in the labeling, can be reasonably expected to result in a significant injury of the user.
2. A critical component in any component of a life support device or system whose failure to perform can be reasonably expected to cause the failure of the life support device or system, or to affect its safety or effectiveness.