

VERY LOW DROP DUAL VOLTAGE REGULATOR

- OUTPUT CURRENT 1 UP TO 500mA
- OUTPUT CURRENT 2 UP TO 1.0A
- LOW DROPOUT VOLTAGE 1
(0.3V @ $I_O = 500\text{mA}$)
- LOW DROPOUT VOLTAGE 2
(0.4V @ $I_O = 1\text{A}$)
- VERY LOW SUPPLY CURRENT (TYP. $50\mu\text{A}$ IN OFF MODE, 1.6mA MAX IN ON MODE)
- LOGIC-CONTROLLED ELECTRONIC SHUTDOWN
- OUTPUT VOLTAGE AVAILABILITY FOR EACH REGULATOR: 1.8V, 2.5V, 3.3V
- INTERNAL CURRENT AND THERMAL LIMIT
- STABLE WITH LOW VALUE (MIN $4.7\mu\text{F}$) AND LOW E.S.R. OUTPUT CAPACITORS
- SUPPLY VOLTAGE REJECTION: 70dB (TYP.)
- TEMPERATURE RANGE (-40°C TO 125°C)

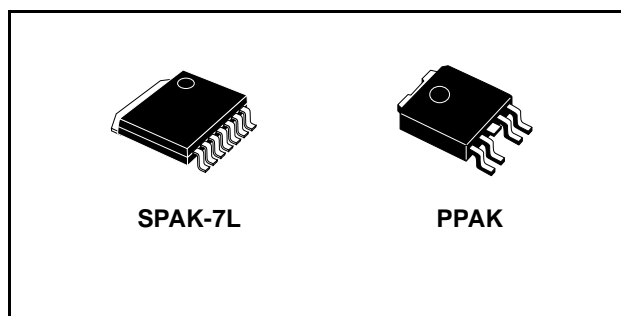

(0.5V) and the very low supply current make it particularly suitable for low noise and low power applications such as PDA, MICRODRIVE and other data storage applications while the used high voltage technology makes this device suitable for consumer applications such as MONITORS AND SET-TOP-BOX. For each V_O a Shutdown Logic Control function is available (TTL compatible) to decrease the total power consumption.

DESCRIPTION

The LDRxxyy is a Very Low Drop Dual Voltage Regulator available in PPAK for the version without inhibit and in SPAK-7L for the version with the shutdown feature. The very low drop-voltage

Figure 1: Block Diagram

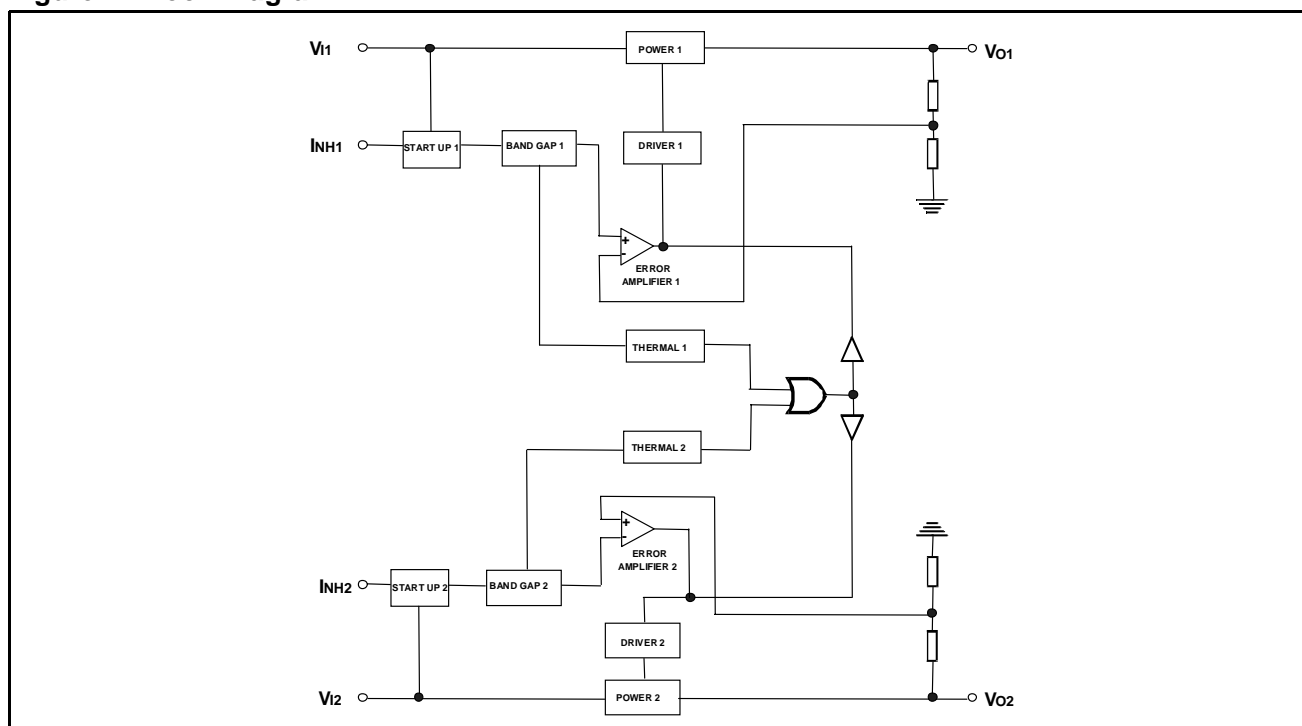

Table 1: Absolute Maximum Ratings

Symbol	Parameter	Value	Unit
V_{I1} & V_{I2}	DC Input Voltage	-0.3 to 15	V
INH	Shutdown Voltage	-0.3 to 15	V
I_O	Output Current	Internally Limited	
P_{TOT}	Power Dissipation	Internally Limited	
T_{STG}	Storage Temperature Range	-50 to +150	°C
T_A	Operating Ambient Temperature Range	-40 to +125	°C

Absolute Maximum Rating are those values beyond which damage to the device may occur. Functional operation under these conditions is not implied.

Table 2: Thermal Data

Symbol	Parameter	PPAK	SPAK-7L	Unit
R_{THJ-C}	Junction to case thermal resistance	8	2	°C/W

Figure 2: Connection Diagram (top view)

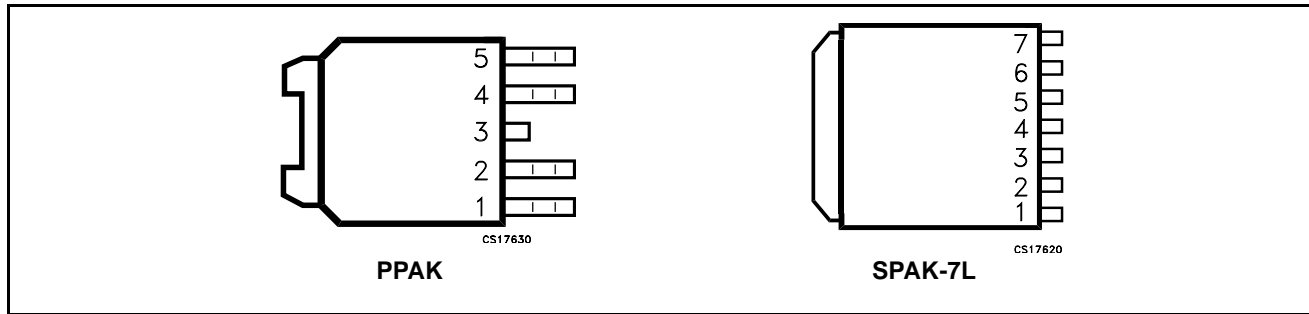

Table 3: Pin Description

Symbol	Pin N° for PPAK	Pin N° for SPAK-7L	Name and Function
GND	3	4	Ground pin
V_{I1}	2	2	Input 1 Supply Pin. Bypass with a 2.2µF capacitor to GND
V_{I2}	1	1	Input 2 Supply Pin. Bypass with a 2.2µF capacitor to GND
V_{INH1}		3	Enable 1 Pin. Internally connected to V_{I1} in the PPAK version
V_{INH2}		5	Enable 2 Pin. Internally connected to V_{I2} in the PPAK version
V_{O1}	4	6	Output 1 Pin. Bypass with a 4.7µF capacitor to GND Port
V_{O2}	5	7	Output 2 Pin. Bypass with a 4.7µF capacitor to GND Port
N.C.			Not Internally Connected

Table 4: Order Codes

V_{O1}	V_{O2}	TYPE	PART NUMBERS	
			SPAK-7L	PPAK
1.8 V	2.5 V	LDR1825	LDR1825K7-R	LDR1825PT-R
1.8 V	3.3 V	LDR1833	LDR1833K7-R	LDR1833PT-R
2.5 V	1.8 V	LDR2518	LDR2518K7-R	LDR2518PT-R
2.5 V	3.3 V	LDR2533	LDR2533K7-R	LDR2533PT-R
3.3 V	1.8 V	LDR3318	LDR3318K7-R	LDR3318PT-R
3.3 V	2.5 V	LDR3325	LDR3325K7-R	LDR3325PT-R

Table 5: Electrical Characteristics ($V_{I1} = V_{O1} + 2V$, $V_{I2} = V_{O2} + 2V$, $V_{INH1} = V_{INH2} = 2.5V$, $C_{I1,2} = 2.2\mu F$, $C_{O1,2} = 4.7\mu F$, $I_{O1} = I_{O2} = 10mA$, $T_A = -40^\circ C$ to $125^\circ C$, unless otherwise specified. Typical values are referred at $T_A = 25^\circ C$)

Symbol	Parameter	Test Conditions	Min.	Typ.	Max.	Unit
V_{O1}	Output Voltage 1		-5	V_{NOM1}	+5	%V
V_{O2}	Output Voltage 2		-5	V_{NOM2}	+5	%V
V_{DROP1}	Dropout Voltage 1 ⁽¹⁾	$I_{O1} = 500mA$		0.3	0.7	V
V_{DROP2}	Dropout Voltage 2 ⁽¹⁾	$I_{O2} = 1A$		0.4	0.8	V
ΔV_{O1}	Line Regulation 1	$V_{I1} = V_{O1} + 2V$ to $V_{O1} + 7V$, $I_O = 250mA$		15	30	mV
ΔV_{O2}	Line Regulation 2	$V_{I2} = V_{O2} + 2V$ to $V_{O2} + 7V$, $I_O = 500mA$		15	40	mV
ΔV_{O1}	Load Regulation 1	$V_{I1} = V_{O1} + 2V$, $I_{O1} = 10$ to $500mA$		10		mV
ΔV_{O2}	Load Regulation 2	$V_{I2} = V_{O2} + 2V$, $I_{O2} = 10mA$ to $1A$		60		mV
I_{STOT}	Total Supply Current	$I_{O1} = I_{O2} = NO$ LOAD		2		mA
I_S	1 Channel Supply Current	NO LOAD		1		mA
I_{QMAX}	Quiescent Current	$I_{O1} = 500mA$, $I_{O2} = 1A$		30		mA
I_{SC1}	Short Circuit Current 1	$T_A = 25^\circ$	500	800		mA
I_{SC2}	Short Circuit Current 2	$T_A = 25^\circ$	1	1.6		A
V_{INH-H}	Enable Voltage HIGH		2.4			V
V_{INH-L}	Enable Voltage LOW				0.8	V
I_{INH}	Enable Pin Current	$V_{INH} = 5V$		6		μA
SVR	Supply Voltage Rejection ⁽²⁾	$V_{I1,2} = V_{O1,2} + 3V \pm 1V$, $I_{O1,2} = 10$ mA, $f = 120Hz$		70		dB
ϵ_N	RMS Output Noise ⁽²⁾	Bandwidth of 10Hz to 100KHz		0.003		% V_O

(1): This test is not performed for $V_O < 2.5V$.

(2): Guaranteed by design, but not tested in production.

Figure 3: Typical Application Circuit

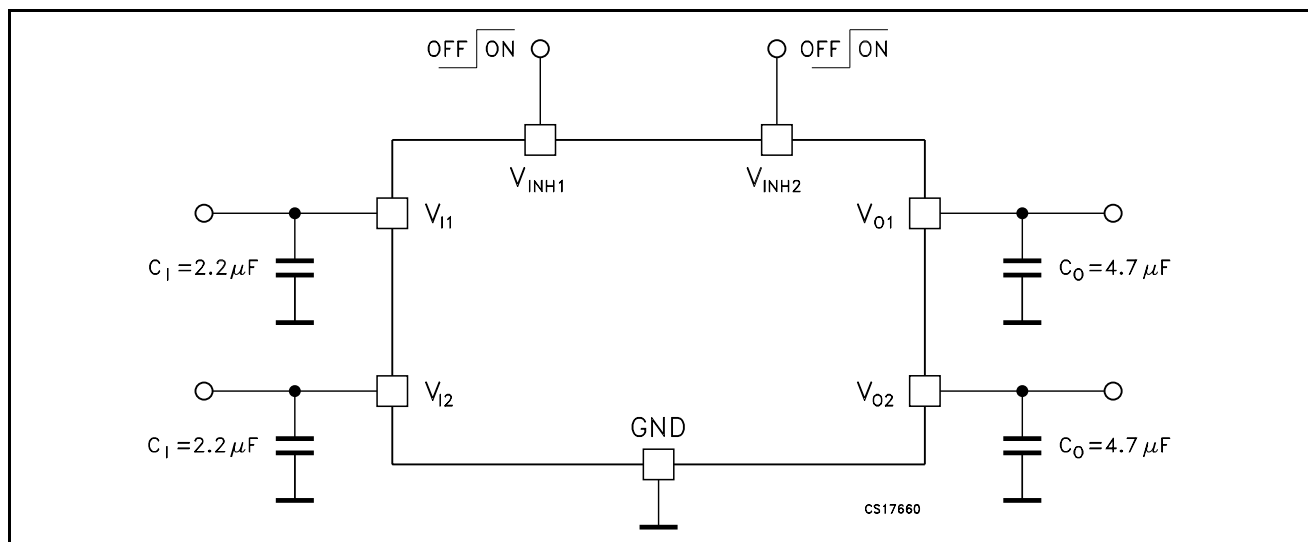

TYPICAL CHARACTERISTICS (unless otherwise specified $T_j = 25^\circ\text{C}$)

Figure 4: Dropout Voltage (V_{O1}) vs Temperature

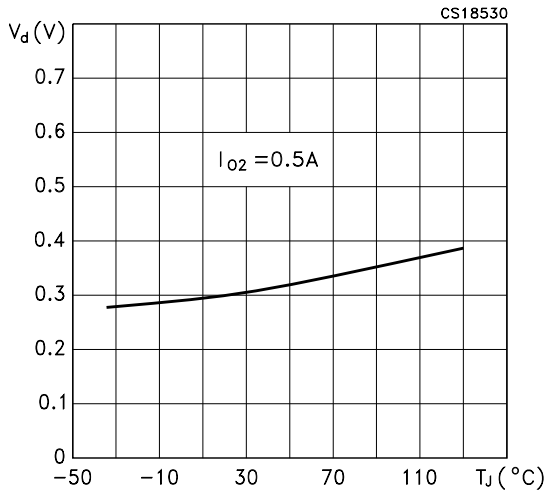

Figure 5: Dropout Voltage (V_{O2}) vs Temperature

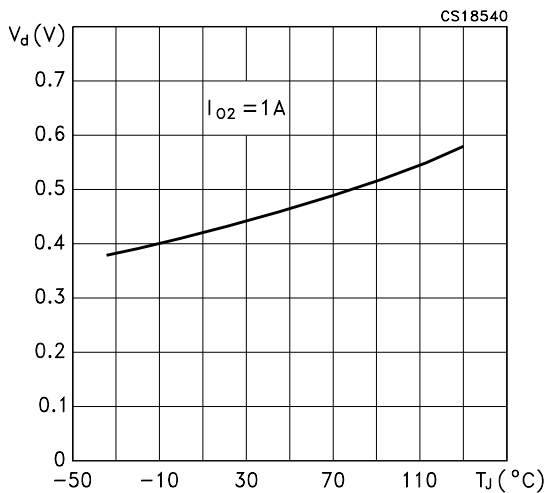

Figure 6: Output Voltage (V_{O1}) vs Temperature

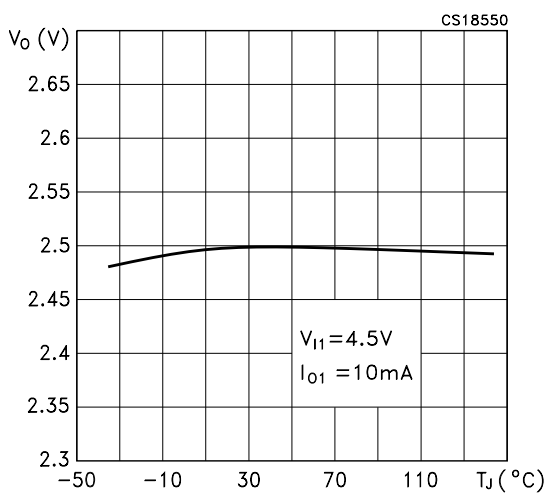

Figure 7: Output Voltage (V_{O2}) vs Temperature

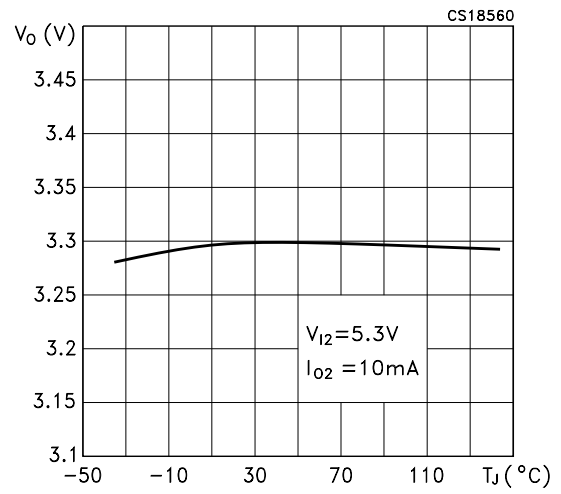

Figure 8: Line Regulation (V_{O1}) vs Temperature

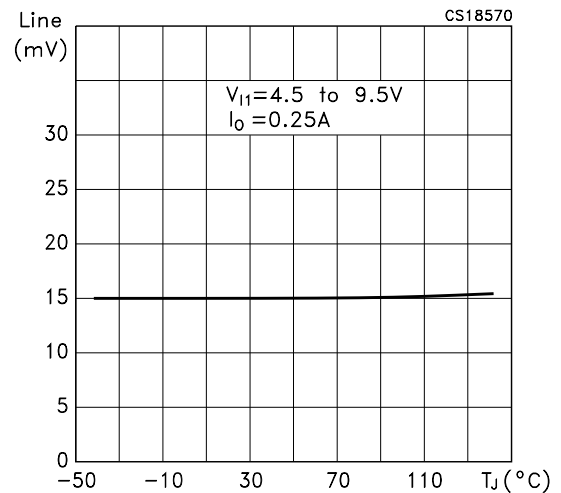

Figure 9: Load Regulation (V_{O1}) vs Temperature

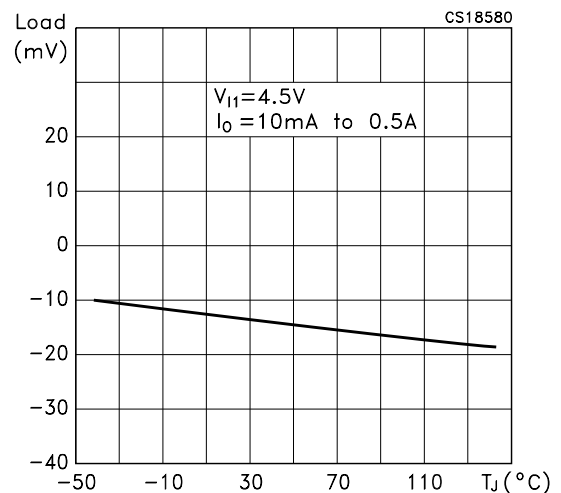

Figure 10: Line Regulation (V_{O2}) vs Temperature

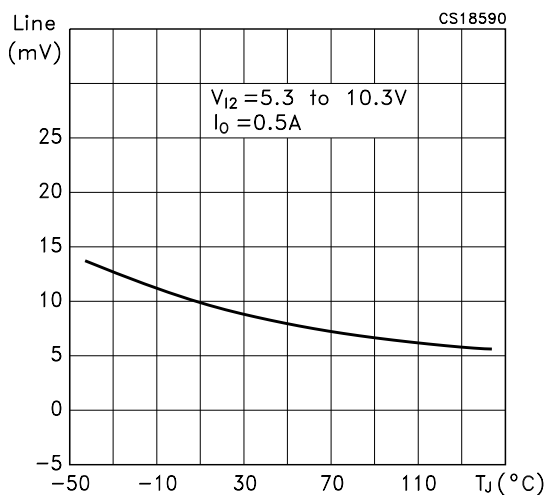

Figure 13: Short Circuit Current (V_{O2}) vs Drop Voltage

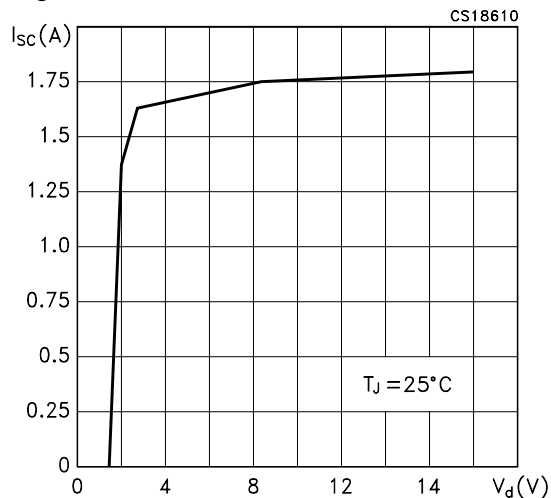

Figure 11: Load Regulation (V_{O2}) vs Temperature

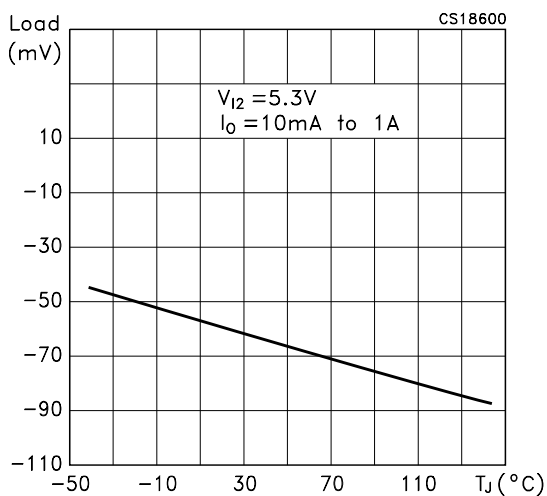

Figure 14: Inhibit Voltage vs Temperature

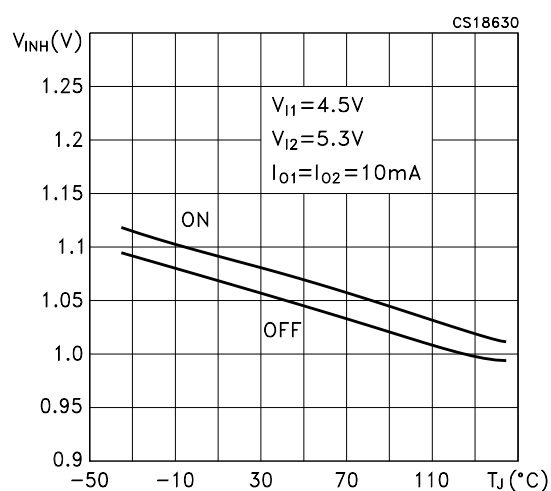

Figure 12: Short Circuit Current (V_{O1}) vs Drop Voltage

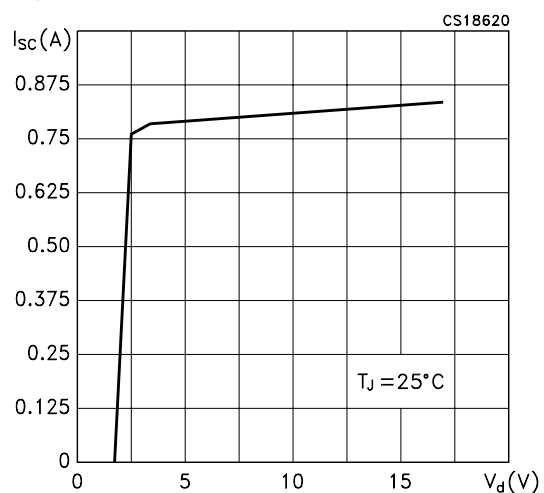

Figure 15: One Channel Inhibit Current vs Temperature

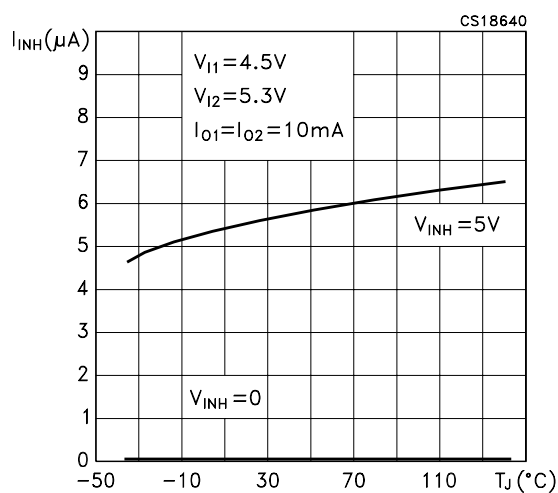

Figure 16: Supply Voltage Rejection vs (V_{O1}) Temperature

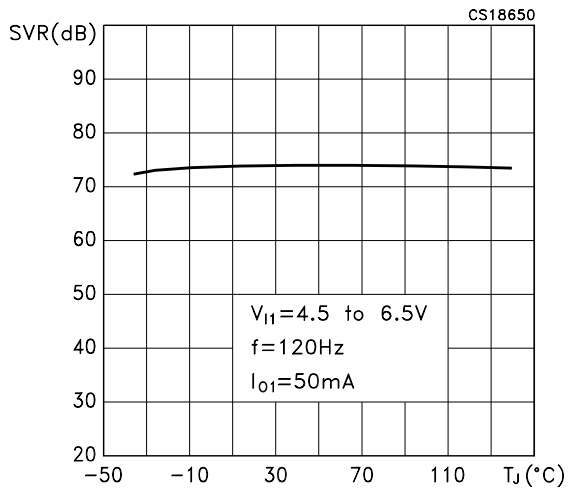

Figure 19: Supply Voltage Rejection (V_{O2}) vs Frequency

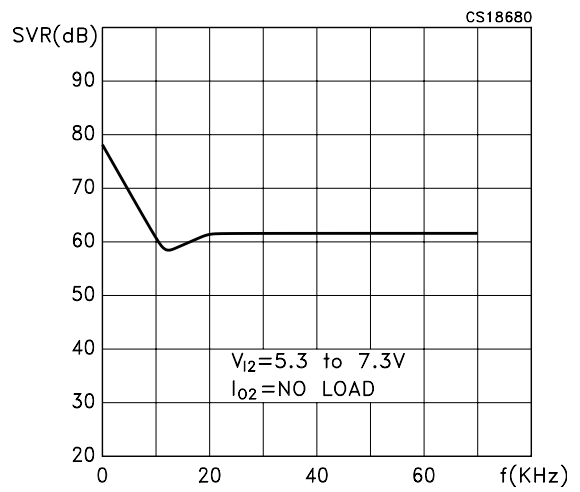

Figure 17: Supply Voltage Rejection vs (V_{O2}) Temperature

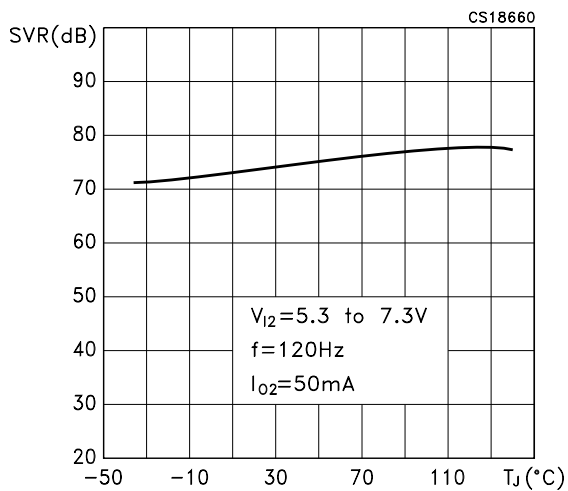

Figure 20: Maximum Total Quiescent Current vs Temperature

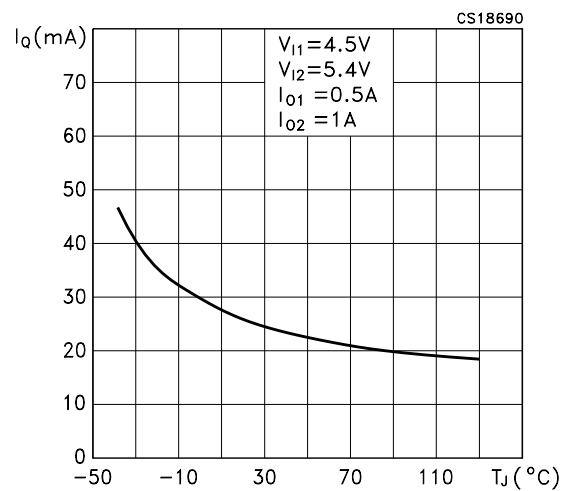

Figure 18: Supply Voltage Rejection (V_{O1}) vs Frequency

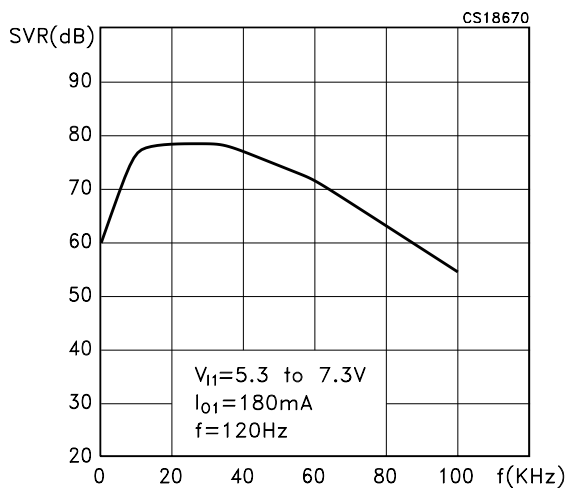

Figure 21: Total Supply Current vs Temperature

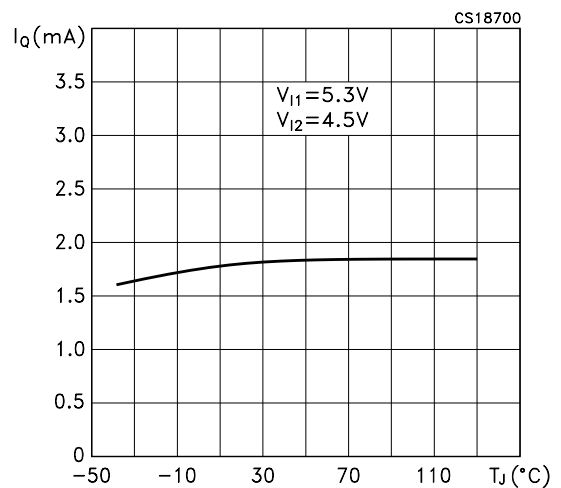

Figure 22: Quiescent Current (V_{O1}) vs Output Current

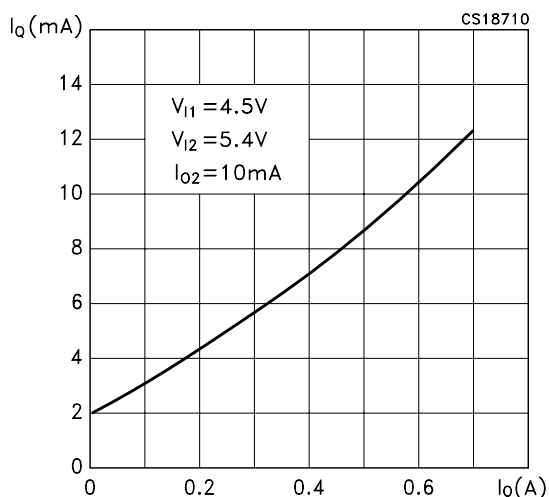

Figure 23: Quiescent Current (V_{O2}) vs Output Current

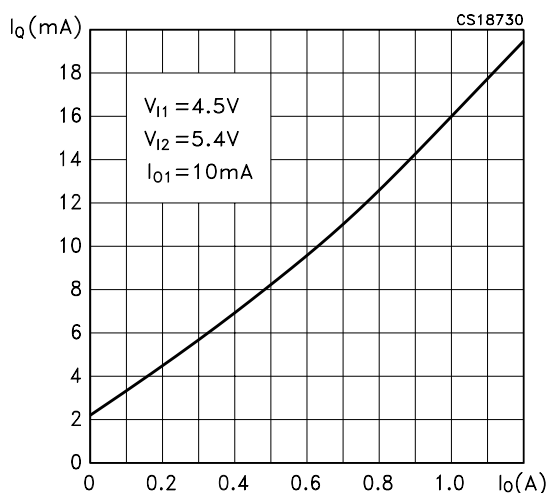

Figure 24: Thermal Protection vs V_{O1}

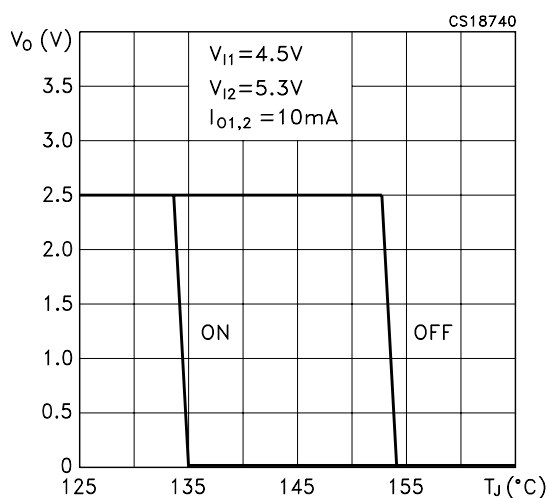
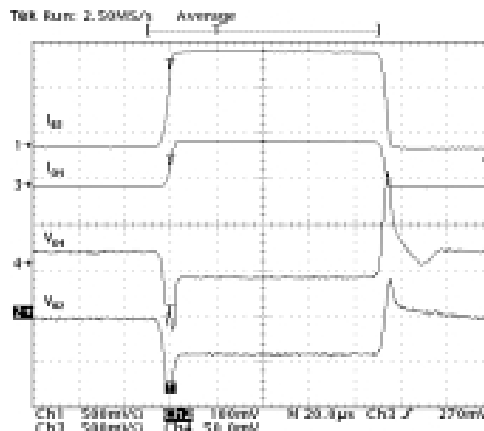
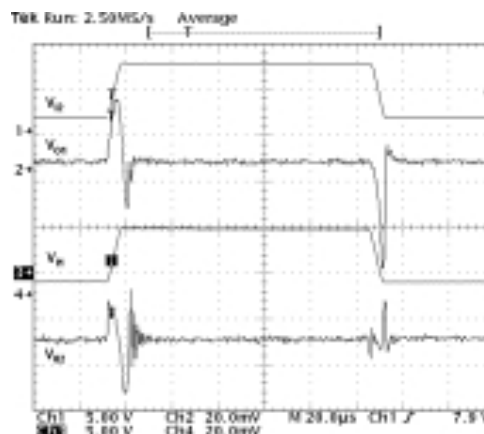

Figure 25: Load Transient



$C_{11,2}=1\mu F$, $C_{O1,2}=2.2\mu F$, $V_{INH1,2}=2.5V$, $V_{11}=4.5V$, $V_{12}=5.3V$, $I_{O1}=5mA$ to $0.5A$, $I_{O2}=5mA$ to $1A$, $t_{RISE}=t_{FALL}=4.2\mu s$

Figure 26: Line Transient $V_{O1,2}$



$C_{11,2}=0$, $C_{O1,2}=2.2\mu F$, $V_{11}=4.4$ to $10.4V$, $V_{12}=5.3$ to $11.3V$, $I_{O1}=0.25A$, $I_{O2}=0.5A$, $t_{RISE}=t_{FALL}=4.4\mu s$

Figure 27: Start up Transient V_{O1}

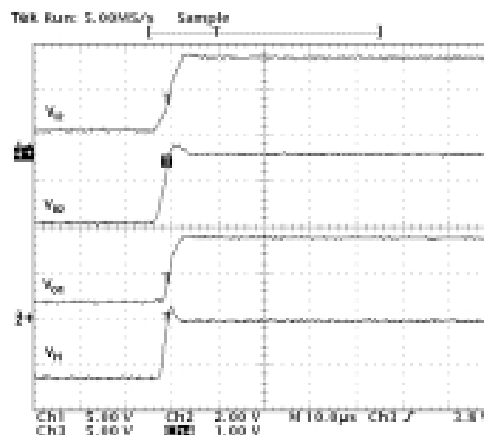

$V_{11}=1.1$ to $8.5V$, $V_{12}=1.2$ to $9.8V$, $I_{O1}=0.25A$, $I_{O2}=0.5A$, $t_{RISE}=5\mu s$

PPAK MECHANICAL DATA

DIM.	mm.			inch		
	MIN.	TYP	MAX.	MIN.	TYP.	MAX.
A	2.2		2.4	0.086		0.094
A1	0.9		1.1	0.035		0.043
A2	0.03		0.23	0.001		0.009
B	0.4		0.6	0.015		0.023
B2	5.2		5.4	0.204		0.212
C	0.45		0.6	0.017		0.023
C2	0.48		0.6	0.019		0.023
D	6		6.2	0.236		0.244
D1		5.1			0.201	
E	6.4		6.6	0.252		0.260
E1		4.7			0.185	
e		1.27			0.050	
G	4.9		5.25	0.193		0.206
G1	2.38		2.7	0.093		0.106
H	9.35		10.1	0.368		0.397
L2		0.8	1		0.031	0.039
L4	0.6		1	0.023		0.039
L5	1			0.039		
L6		2.8			0.110	

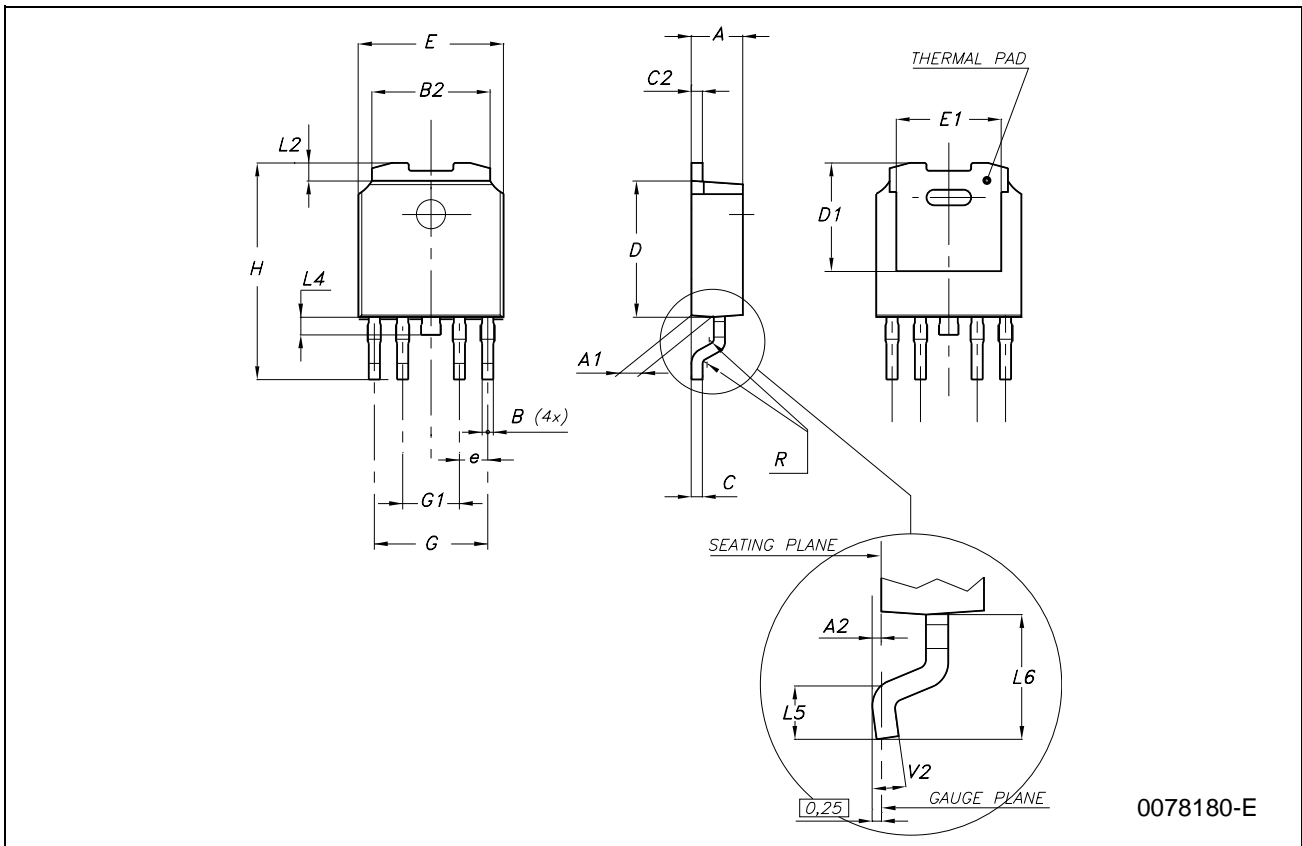

0078180-E

SPAK-7L MECHANICAL DATA

DIM.	mm.			inch		
	MIN.	TYP	MAX.	MIN.	TYP.	MAX.
A	1.78		2.03	0.070		0.080
A2	0.03		0.13	0.001		0.005
C		0.25			0.010	
C1		0.25			0.010	
D	1.02		1.27	0.040		0.050
D1	7.87		8.13	0.310		0.320
F	0.63		0.79	0.025		0.031
G		1.27			0.050	
G1		7.62			0.3	
H1		5.59			0.220	
H2	9.27		9.52	0.365		0.375
H3	8.89		9.14	0.350		0.360
L	10.41		10.67	0.410		0.420
L1		7.49			0.295	
L2	8.89		9.14	0.350		0.360
M	0.79		1.04	0.031		0.041
N		0.25			0.010	
V	3°		6°	3°		6°

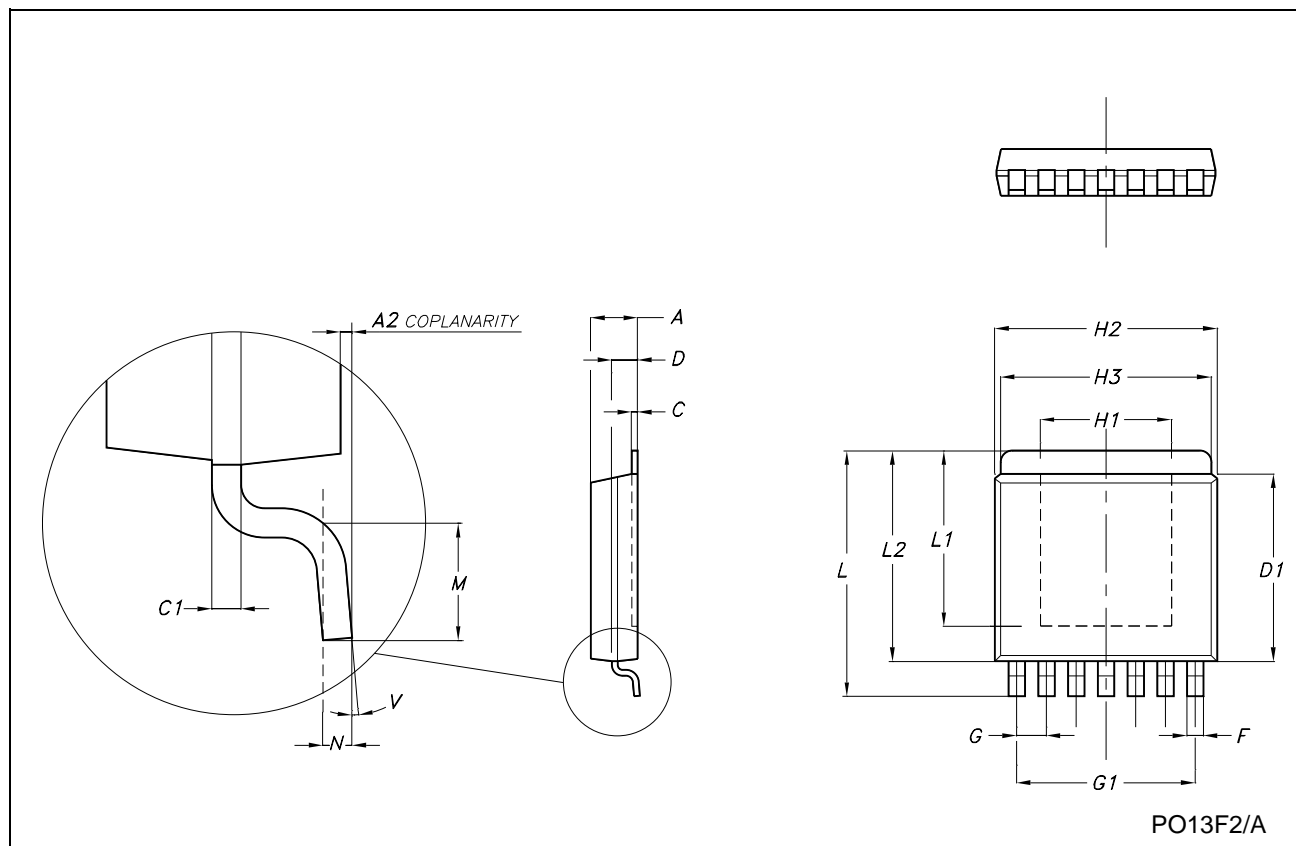

Tape & Reel SPAK-xL MECHANICAL DATA

DIM.	mm.			inch		
	MIN.	TYP	MAX.	MIN.	TYP.	MAX.
A			180			7.086
C	12.8	13.0	13.2	0.504	0.512	0.519
D	20.2			0.795		
N	60			2.362		
T			14.4			0.567
Ao	9.70	9.80	9.90	0.382	0.386	0.390
Bo	10.85	10.95	11.05	0.423	0.427	0.431
Ko	2.30	2.40	2.50	0.090	0.094	0.098
Po	3.9	4.0	4.1	0.153	0.157	0.161
P	11.9	12.0	12.1	0.468	0.472	0.476

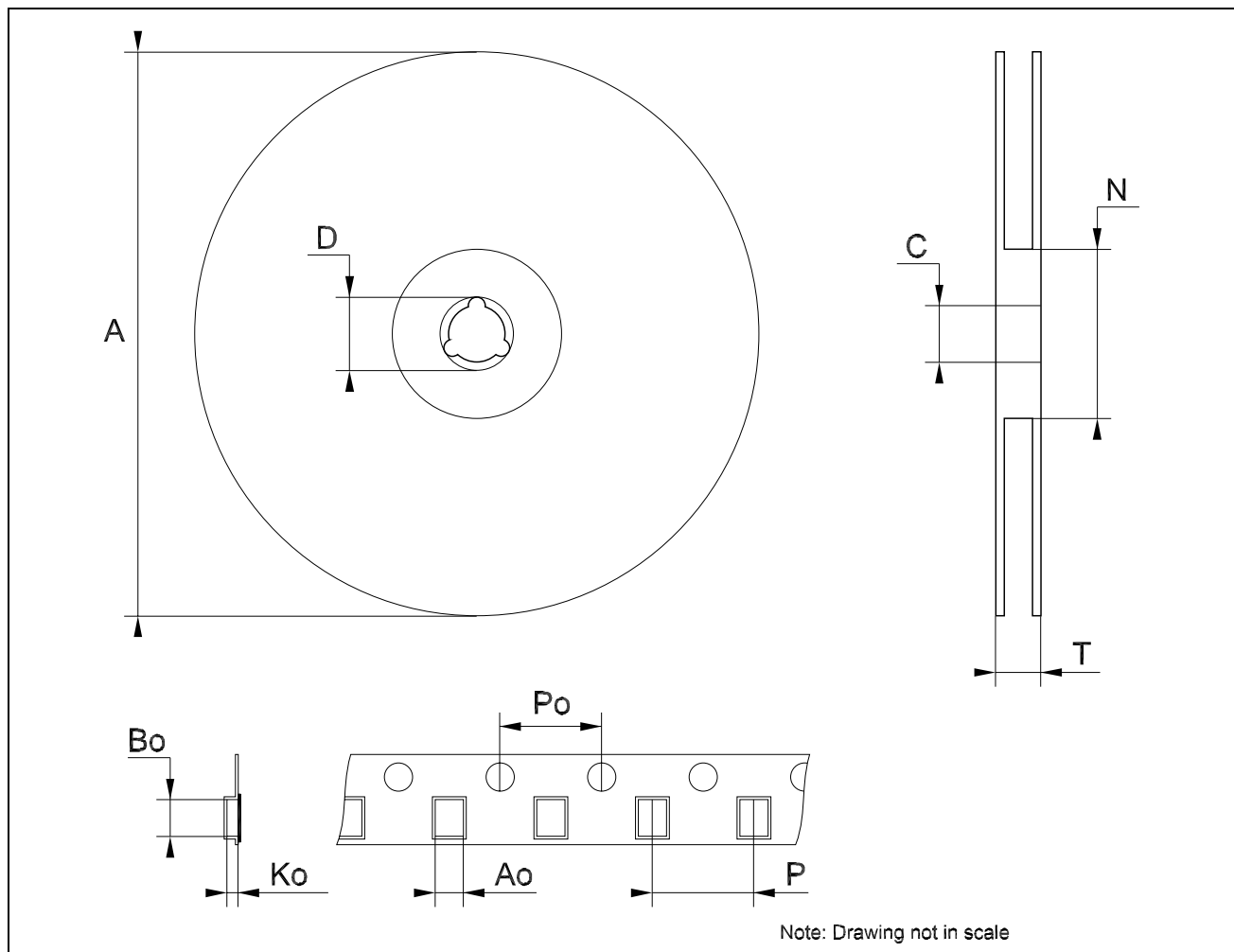

Tape & Reel DPAK-PPAK MECHANICAL DATA

DIM.	mm.			inch		
	MIN.	TYP	MAX.	MIN.	TYP.	MAX.
A			330			12.992
C	12.8	13.0	13.2	0.504	0.512	0.519
D	20.2			0.795		
N	60			2.362		
T			22.4			0.882
Ao	6.80	6.90	7.00	0.268	0.272	0.276
Bo	10.40	10.50	10.60	0.409	0.413	0.417
Ko	2.55	2.65	2.75	0.100	0.104	0.105
Po	3.9	4.0	4.1	0.153	0.157	0.161
P	7.9	8.0	8.1	0.311	0.315	0.319

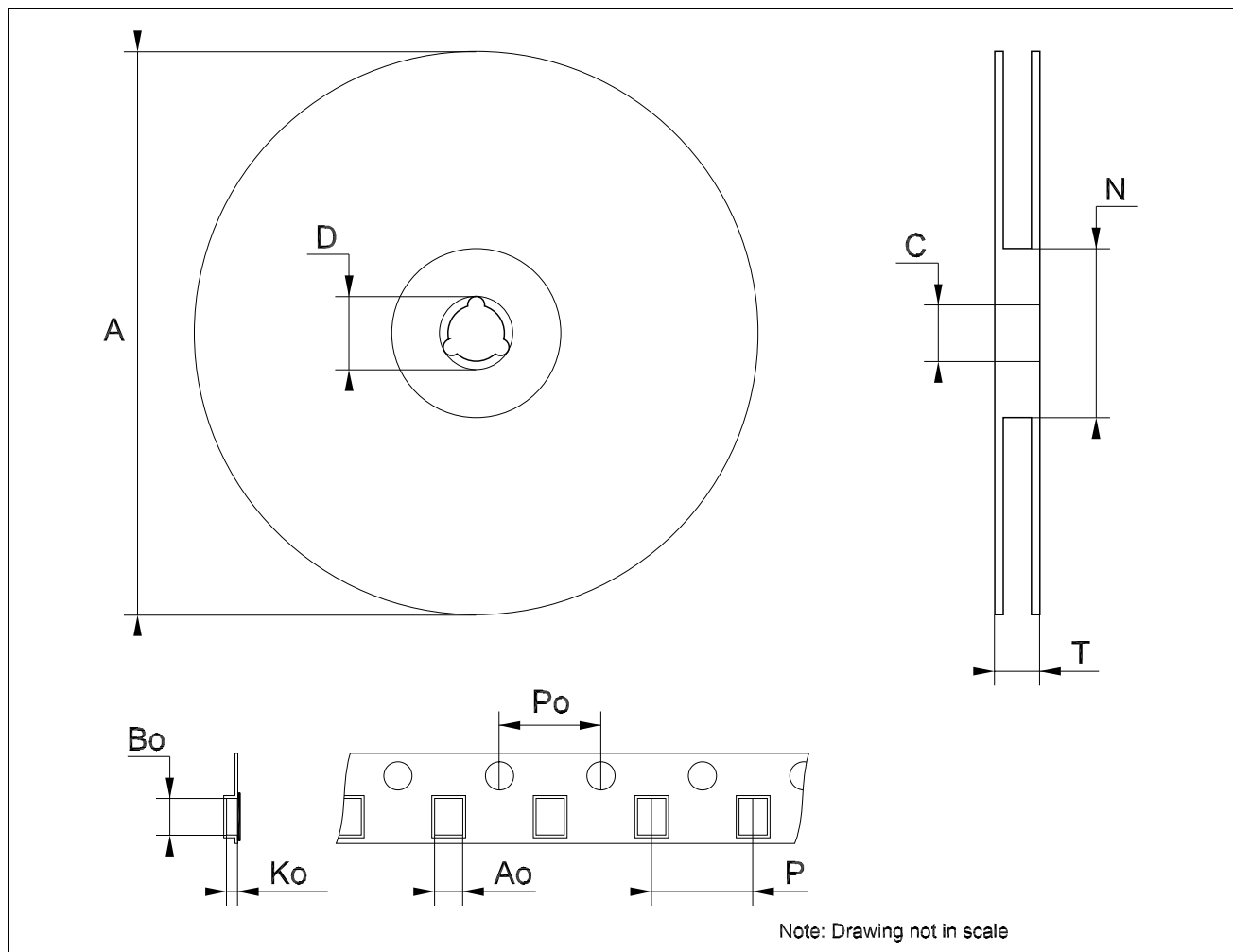

Table 6: Revision History

Date	Revision	Description of Changes
03-Aug-2004	2	Typing correction on tables 1, 3, 5 and figures 3, 6, 10, 11, 14, 17, 22, 23.

Information furnished is believed to be accurate and reliable. However, STMicroelectronics assumes no responsibility for the consequences of use of such information nor for any infringement of patents or other rights of third parties which may result from its use. No license is granted by implication or otherwise under any patent or patent rights of STMicroelectronics. Specifications mentioned in this publication are subject to change without notice. This publication supersedes and replaces all information previously supplied. STMicroelectronics products are not authorized for use as critical components in life support devices or systems without express written approval of STMicroelectronics.

The ST logo is a registered trademark of STMicroelectronics

All other names are the property of their respective owners

© 2004 STMicroelectronics - All Rights Reserved

STMicroelectronics group of companies

Australia - Belgium - Brazil - Canada - China - Czech Republic - Finland - France - Germany - Hong Kong - India - Israel - Italy - Japan -
Malaysia - Malta - Morocco - Singapore - Spain - Sweden - Switzerland - United Kingdom - United States of America

www.st.com

