

**3-terminal Regulator & LDO Regulator series**

# Standard Variable Output LDO Regulator

## BA00DD0W and BA00CC0W Series

---

**●General Description**

The BA00DD0/CC0 series are low-saturation regulators available for outputs up to 2A/1A. The output voltage can be arbitrarily configured using the external resistance. These series of LDO regulators are offered in a broad packaging lineup. This IC has a built-in over-current protection circuit that prevents the destruction of the IC due to output short circuits and a thermal shutdown circuit that protects the IC from thermal damage due to overloading.

**●Features**

- 1) Maximum output current : 2A (BA00DD0 series), 1A(BA00CC0 series)
- 2)  $\pm 1\%$  high-precision output voltage (BA00DD0)
- 3) Low saturation with PNP output
- 4) Built-in over-current protection circuit that prevents the destruction of the IC due to output short circuits
- 5) Built-in thermal shutdown circuit for protecting the IC from thermal damage due to overloading
- 6) Built-in over- voltage protection circuit that prevents the destruction of the IC due to power supply surges
- 7) TO220CP and HRP5 packaging(BA00DD0), and TO220FP/CP and TO252 packaging(BA00CC0)

**●Applications**

Usable in DSP power supplies for DVDs and CDs, FPDs, televisions, personal computers or any other consumer device

**●Line up**
**1A BA00CC0 Series**

Part Number	Package
BA00CC0WT	TO220FP-5
BA00CC0WT-V5	TO220FP-5(V5)
BA00CC0CP-V5	TO220CP-V5
BA00CC0WFP	TO252-5

**2A BA00DD0 Series**

Part Number	Package
BA00DD0CP-V5	TO220CP-V5
BA00DD0WHFP	HRP-5

● ABSOLUTE MAXIMUM RATINGS(Ta=25°C)

Parameter	Symbol	Limits	Unit
Input Power Supply Voltage*1	Vcc	-0.3 ~ +35	V
Power Dissipation *2	Pd	2300(HRP5)	mW
		1300(TO252-5)	
		2000(TO220FP/CP)	
Operating Temperature Range	Topr	-40 ~ +125	°C
Ambient Storage Temperature	Tstg	-55 ~ +150	°C
Junction Temperature	Tjmax	+150	°C
Output Control Terminal Voltage	VCTL	-0.3 ~ +Vcc	V
Voltage Applied to the Tip *3	Vcc peak	+50	V

\* 1 Must not exceed Pd

\* 2 HRP5 : In cases in which Ta≥25°C when a 70mm×70mm×1.6mm glass epoxy board is used, the power is reduced by 18.4 mW/°C.  
TO252-5 : In cases in which Ta≥25°C when a 70mm×70mm×1.6mm glass epoxy board is used, the power is reduced by 10.4 mW/°C.  
TO252FP-5 : No heat sink. When Ta≥25°C, the power is reduced by 16 mW/°C.

\* 3 Applied voltage : 200msec or less (tr≥1msec)

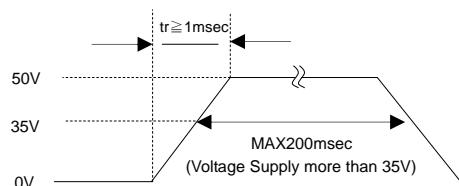

● Recommended Operating Range (Ta=25°C)

Parameter	Symbol	Min.	Max.	Unit
Input Power Supply Voltage	BA00CC0□□	4.0	25.0	V
	BA00DD0□□	3.0	25.0	
Output Current	BA00CC0□□	—	1	A
	BA00DD0□□	—	2	
Output Control Terminal Voltage	VCTL	0	Vcc	V

● Electrical Characteristics(ABRIDGED)

BA00CC0□□ Series (unless specified otherwise, Ta=25°C, Vcc=10V, VCTL=5V, Io=500mA, R1=2.2KΩ, R2=6.8KΩ)

Parameter	Symbol	Min.	Typ.	Max.	Unit	Conditions
C-terminal Voltage	Vc	1.200	1.225	1.250	V	Io=50mA
Circuit Current at the Time of Shutdown	I <sub>sd</sub>	—	0	10	μA	VCTL=0V
Minimum I/O Voltage Difference	ΔVd	—	0.3	0.5	V	Vcc= 0.95×Vo
Output Current Capacity	Io	1.0	—	—	A	
Input Stability	Reg.I	—	20	100	mV	Vcc= 6V→25 V
Load Stability	Reg.L	—	50	150	mV	Io=5mA→1A
Output Voltage Temperature Coefficient*	Tcvo	—	±0.02	—	%/°C	Io=5mA, Tj=0~125°C

\* Design guarantee(100% shipping inspection not performed)

BA00DD0□□ Series (unless specified otherwise, Ta=25°C, Vcc=8V, VCTL=3V, Io=500mA, R1=15KΩ, R2=44KΩ)

Parameter	Symbol	Min.	Typ.	Max.	Unit	Conditions
C-terminal Voltage	V <sub>ADJ</sub>	1.257	1.270	1.283	V	Io=100mA
Circuit Current at the Time of Shutdown	I <sub>sd</sub>	—	0	10	μA	VCTL=0V
Minimum I/O Voltage Difference	ΔVd	—	0.45	0.7	V	Vcc= 0.95×Vo, Io=2A
Output Current Capacity	Io	2.0	—	—	A	
Input Stability	Reg.I	—	15	35	mV	Vcc= 5.7V → 25 V, Io=200mA
Load Stability	Reg.L	—	50	100	mV	Io=0mA→2A
Output Voltage Temperature Coefficient*	Tcvo	—	±0.02	—	%/°C	Io=5mA, Tj=0~125°C

\* Design guarantee(100% shipping inspection not performed)

● Reference Data

BA00CC0□□ (3.3V preset voltage)

(Unless specified otherwise,  $V_{CC}=10V$ ,  $V_{OUT}=3.3V$  preset,  $V_{CTL}=3V$ ,  $I_o=0mA$ ,  $R_1=2.2K\Omega$ , and  $R_2=6.8K\Omega$ )

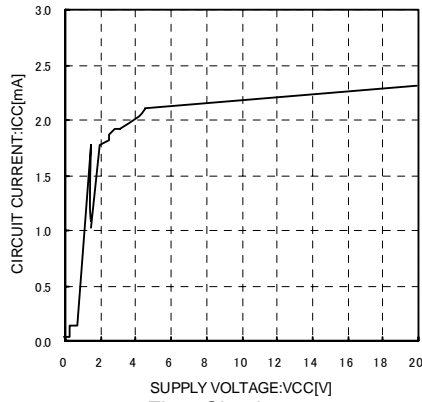

Fig.1 Circuit current

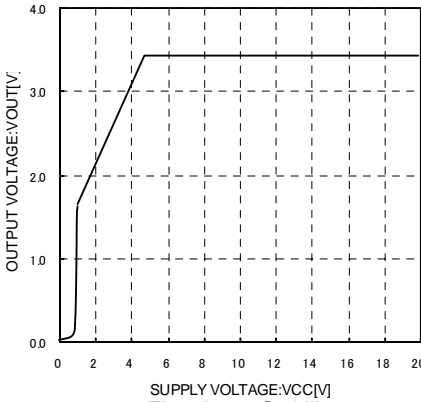

Fig.2 Input Stability

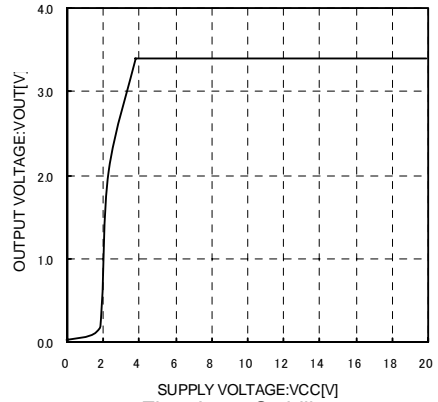

Fig.3 Input Stability

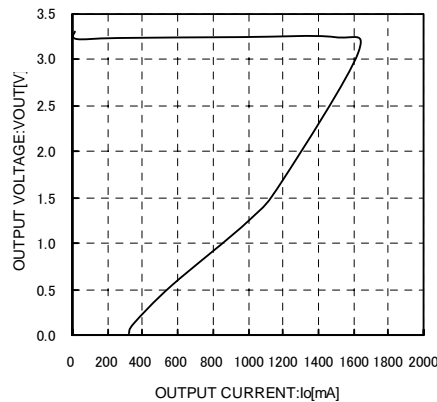

Fig.4 Load Stability

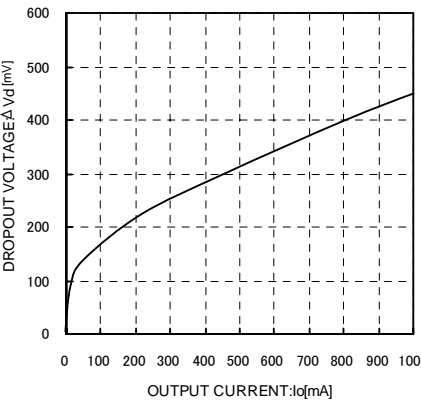

Fig.5 Input/Output Voltage Difference  $I_o-\Delta V_d$  Characteristics ( $V_{CC}=2.95V$ )

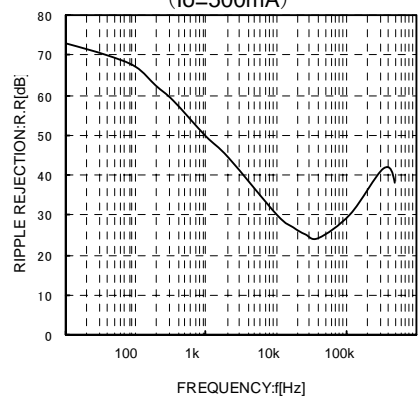

Fig.6 Ripple Rejection Characteristics ( $I_o=100mA$ )

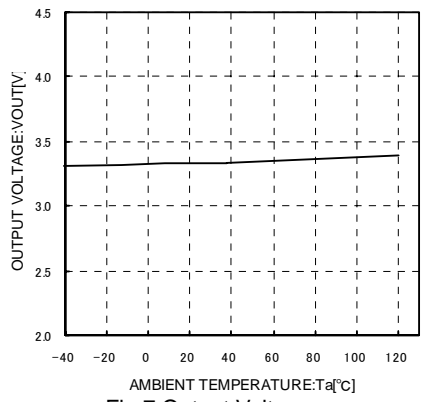

Fig.7 Output Voltage Temperature Characteristics

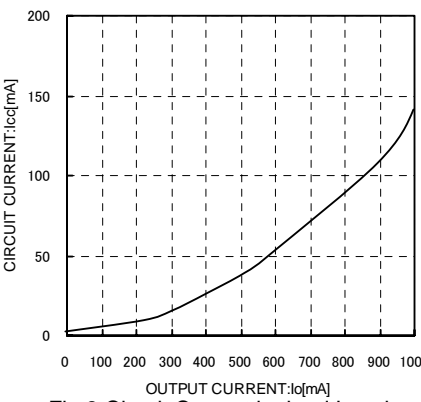

Fig.8 Circuit Current by load Level ( $I_{oUT}=0mA \rightarrow 1A$ )

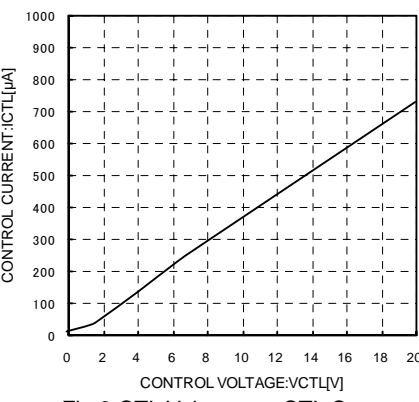

Fig.9 CTL Voltage vs. CTL Current

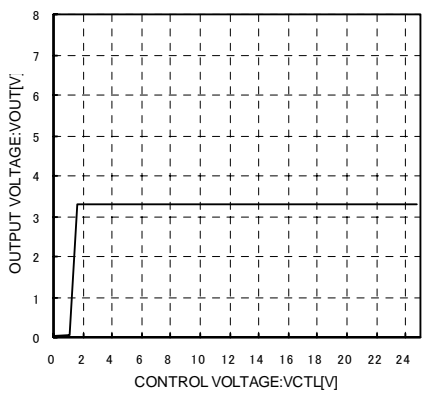

Fig.10 CTL Voltage vs. Output Voltage

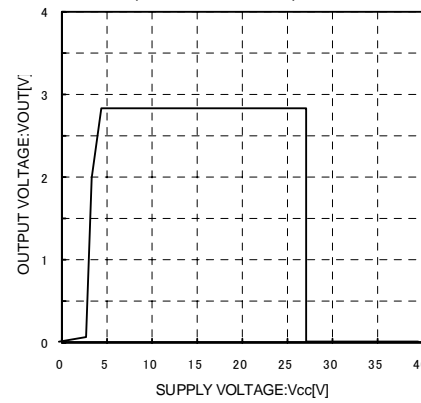

Fig.11 Overvoltage Operating Characteristics ( $I_o=200mA$ )

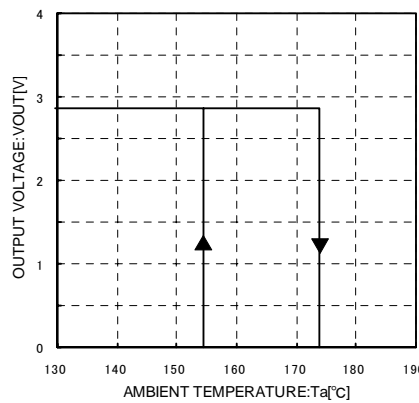

Fig.12 Thermal Shutdown Circuit Characteristics

● Reference Data

BA00DD0□□ (5.0V preset voltage)

(Unless specified otherwise,  $V_{CC}=8V$ ,  $V_{OUT}=5V$  preset,  $V_{CTL}=3V$ ,  $I_o=0mA$ ,  $R_1=15K\Omega$ , and  $R_2=44K\Omega$ )

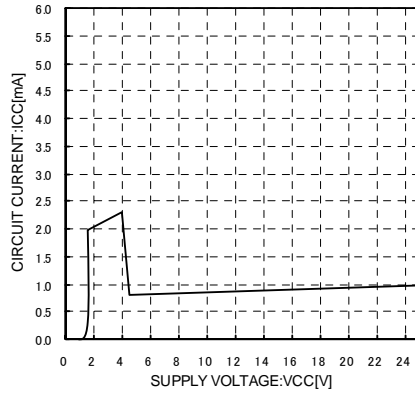

Fig.13 Circuit Current

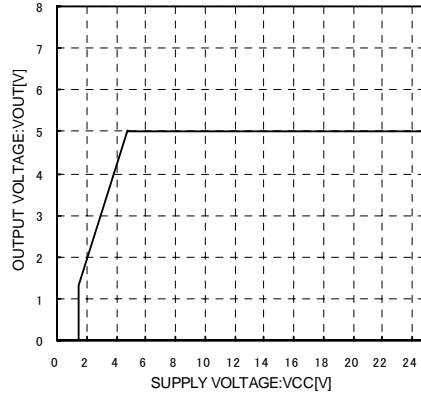

Fig.14 Input Stability

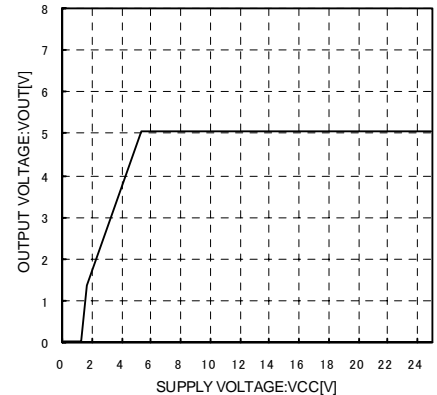

Fig.15 Input Stability  
( $I_o=2A$ )

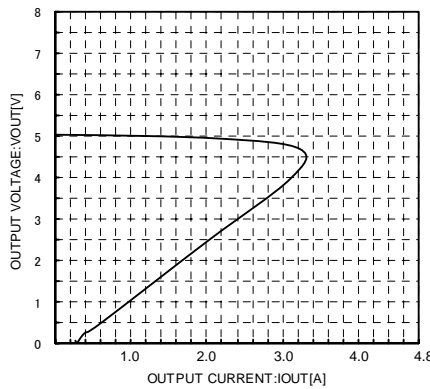

Fig.16 Load Stability

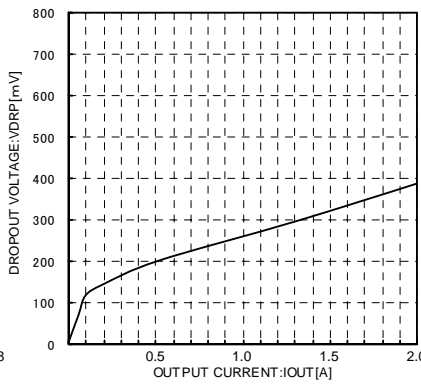

Fig.17 Input/Output Voltage Difference  
 $I_{out} - \Delta V_d$  Characteristics ( $V_{CC}=4.75V$ )

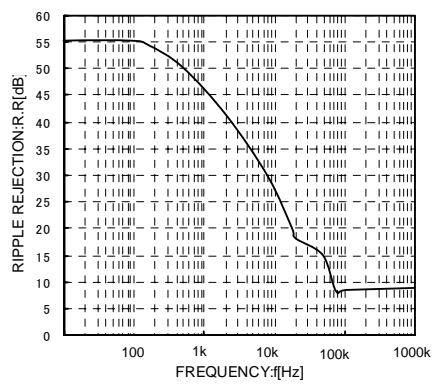

Fig.18 Ripple Rejection Characteristics  
( $I_{out}=100mA$ )

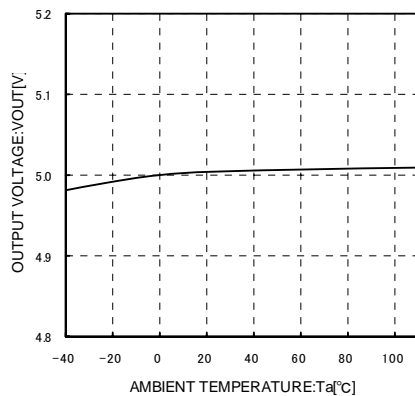

Fig.19 Output Voltage  
Temperature Characteristics

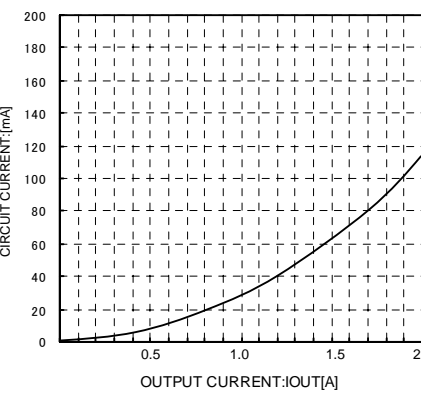

Fig.20 Circuit Current by load Level  
( $I_{OUT}=0mA \rightarrow 2A$ )

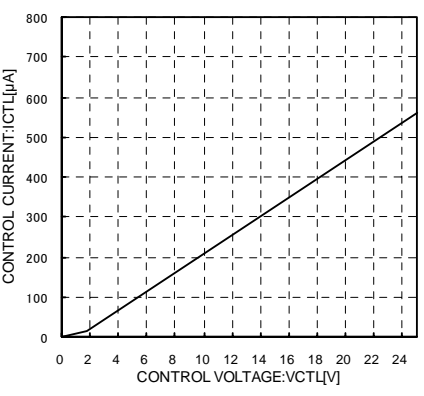

Fig.21 CTL Voltage vs. CTL Current

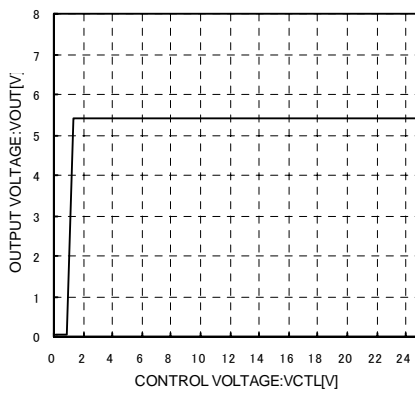

Fig.22 CTL Voltage vs. Output Voltage

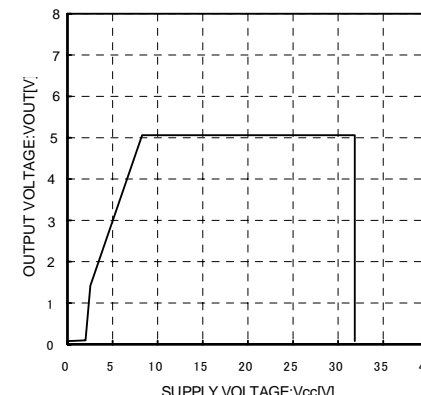

Fig.23 Overvoltage Operating  
Characteristics ( $I_o=200mA$ )

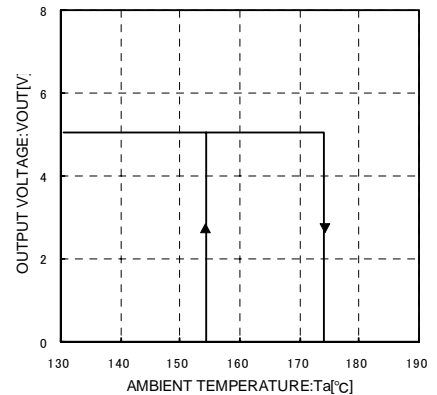

Fig.24 Thermal Shutdown  
Circuit Characteristics

● Block Diagrams

[BA00CC0WFP]  
[BA00DD0WHFP]

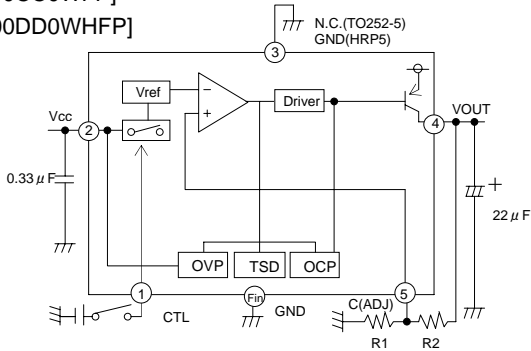
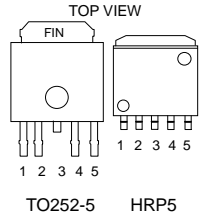

Fig.25



PINNo.	Symbol	Function
1	CTL	Output voltage ON/OFF control
2	VCC	Power supply voltage input
3	N.C./GND	Unconnected terminal/GND*
4	OUT	Voltage output
5	C	Output voltage regulation terminal
FIN	GND	GND

\*TO252-5 is N.C., and HRP5 is GND

[BA00CC0WT]  
[BA00DD0WT]

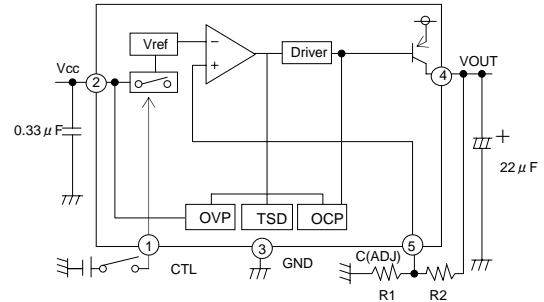
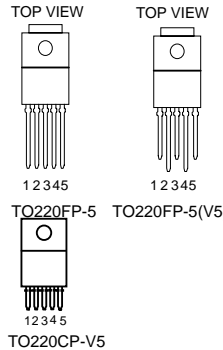

Fig.26



PINNo.	Symbol	Function
1	CTL	Output voltage ON/OFF control
2	VCC	Power supply voltage input
3	GND	GND
4	OUT	Voltage output
5	ADJ	Output voltage regulation terminal

● Input / Output Equivalent Circuit Diagrams

< BA00CC0WT/BA00CC0WFP >

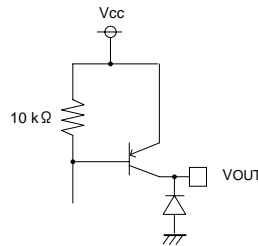
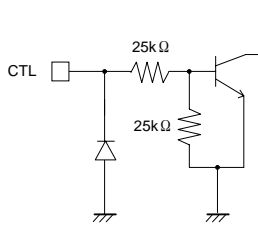
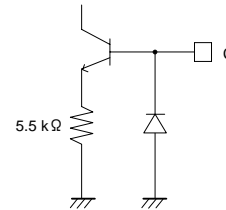

Fig.27



< BA00DD0WT/BA00DD0WFP >

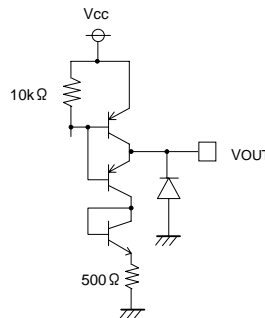
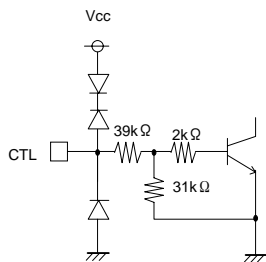

Fig.28

● Output Voltage Configuration Method

Please connect resistors R1 and R2 (which determines the output voltage) as shown in Fig.29.

Please be aware that the offset due to the current that flows from the ADJ terminal becomes large when resistors with large values are used. The use of resistors with R1=2KΩ to 15 KΩ is recommended.

$$V_o = V_c (V_{ADJ}) \times \left( 1 + \frac{R_2}{R_1} \right)$$

BA□□CC0□□ V<sub>c</sub> : 1.225 (Typ.)

BA□□DD0□□ V<sub>ADJ</sub> : 1.270 (Typ.)

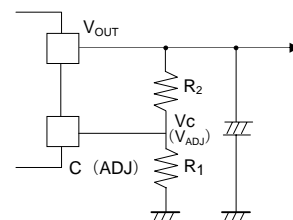

Fig.29

● Thermal Design

HRP-5

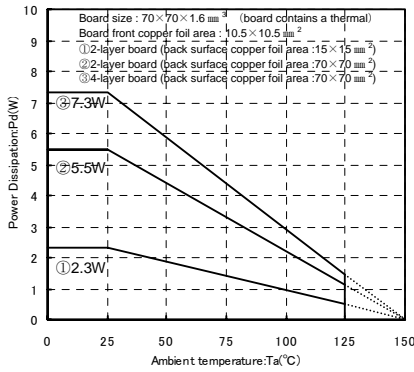

Fig.30

To225FP-5

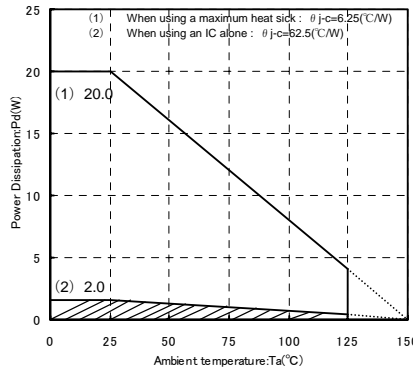

Fig.31

TO252-5

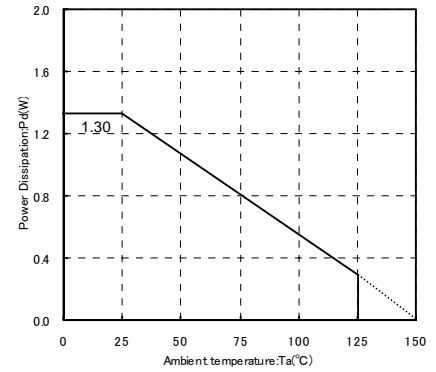

Fig.32

When using at temperatures over  $T_a=25^\circ\text{C}$ , please refer to the heat reducing characteristics shown in Fig.30 through 32. The IC characteristics are closely related to the temperature at which the IC is used, so it is necessary to operate the IC at temperatures less than the maximum junction temperature  $T_{j\text{MAX}}$ .

Fig.31 shows the acceptable loss and heat reducing characteristics of the TO220FP package. The portion shown by the diagonal line is the acceptable loss range that can be used with the IC alone. Even when the ambient temperature  $T_a$  is a normal temperature ( $25^\circ\text{C}$ ), the chip (junction) temperature  $T_j$  may be quite high so please operate the IC at temperatures less than the acceptable loss  $P_d$ .

The calculation method for power consumption  $P_c$ (W) is as follows :

$$P_c = (V_{cc} - V_o) \times I_o + V_{cc} \times I_{cca}$$

$$\text{Acceptable loss } P_d \leq P_c$$

$V_{cc}$  : Input voltage  
 $V_o$  : Output voltage  
 $I_o$  : Load current  
 $I_{cca}$  : Circuit current

Solving this for load current  $I_o$  in order to operate within the acceptable loss,

$$I_o \leq \frac{P_d - V_{cc} \times I_{cca}}{V_{cc} - V_o}$$

(Please refer to Figs.8 and 20 for  $I_{cca}$ .)

It is then possible to find the maximum load current  $I_{o\text{MAX}}$  with respect to the applied voltage  $V_{cc}$  at the time of thermal design.

Calculation Example

Example 1) When  $T_a=85^\circ\text{C}$ ,  $V_{cc}=8.3\text{V}$ ,  $V_o=3.3\text{V}$ , BA33DD0WT

$$I_o \leq \frac{1.04 - 8.3 \times I_{cca}}{5}$$

$$I_o \leq 200\text{mA} \quad (I_{cca} : 2\text{mA})$$

(With the IC alone :  $\theta_{ja}=62.5^\circ\text{C/W} \rightarrow -16\text{mW}/^\circ\text{C}$   
 $25^\circ\text{C}=2000\text{mW} \rightarrow 85^\circ\text{C}=1040\text{mW}$ )

Please refer to the above information and keep thermal designs within the scope of acceptable loss for all operating temperature ranges. The power consumption  $P_c$  of the IC when there is a short circuit (short between  $V_o$  and GND) is :

$$P_c = V_{cc} \times (I_{cca} + I_{short})$$

$I_{short}$  : Short circuit current

● Terminal Vicinity Settings and Cautions

•  $V_{cc}$  Terminal

Please attach a capacitor (greater than  $0.33\ \mu\text{F}$ ) between the  $V_{cc}$  and GND.

The capacitance values differ depending on the application, so please chose a capacitor with sufficient margin and verify the operation on an actual board.

• CTL Terminal

The CTL terminal is turned ON at 2.0V and higher and OFF at 0.8V and lower within the operating power supply voltage range.

The power supply and the CTL terminal may be started up and shut down in any order without problems.

●  $V_o$  Terminal

Please attach an anti-oscillation capacitor between  $V_{out}$  and GND. The capacitance of the capacitor may significantly change due to factors such as temperature changes, which may cause oscillations. Please use a tantalum capacitor or aluminum electrolytic capacitor with favorable characteristics and small external series resistance (ESR) even at low temperatures. The output oscillates regardless of whether the ESR is large or small. Please use the IC within the stable operating region while referring to the ESR characteristics reference data shown in Figs.33 through 35. In cases where there are sudden load fluctuations, the a large capacitor is recommended.

Below figure , it is ESR-to- $I_o$  stability Area characteristics ,measured by  $22\ \mu\text{F}$  -ceramic-capacitor and resistor connected in series.

This characteristics is not equal value perfectly to  $22\ \mu\text{F}$  -aluminum electrolytic capacitor in order to measurement method.

Note, however, that the stable range suggested in the figure depends on the IC and the resistance load involved, and can vary with the board's wiring impedance, input impedance, and/or load impedance. Therefore, be certain to ascertain the final status of these items for actual use.

Keep capacitor capacitance within a range of  $22\ \mu\text{F} \sim 1000\ \mu\text{F}$ . It is also recommended that a  $0.33\ \mu\text{F}$  bypass capacitor be connected as close to the input pin-GND as location possible. However, in situations such as rapid fluctuation of the input voltage or the load, please check the operation in real application to determine proper capacitance.

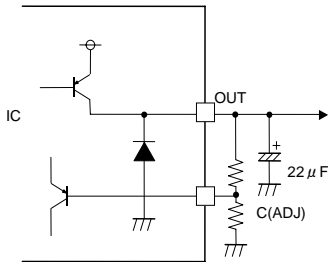

Fig.33: Output equivalent circuit

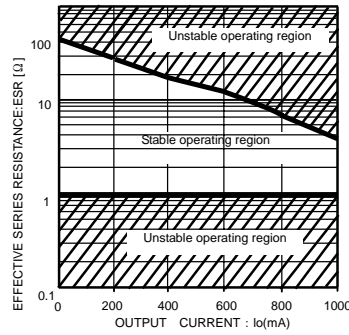

Fig.34:  $I_o$  vs. ESR characteristics  
(BA□□CC0,  $22\ \mu\text{F}$ )

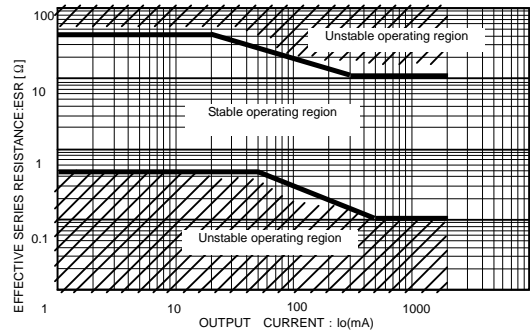

Fig.35:  $I_o$  vs. ESR characteristics  
(BA□□DD0,  $22\ \mu\text{F}$ )

●Other

1) Protection Circuits

Overcurrent Protection Circuit

A built-in overcurrent protection circuit corresponding to the current capacity prevents the destruction of the IC when there are load shorts. This protection circuit is a "7"-shaped current control circuit that is designed such that the current is restricted and does not latch even when a large current momentarily flows through the system with a high-capacitance capacitor. However, while this protection circuit is effective for the prevention of destruction due to unexpected accidents, it is not suitable for continuous operation or transient use. Please be aware when creating thermal designs that the overcurrent protection circuit has negative current capacity characteristics with regard to temperature (Refer to Figs.4 and 16).

Thermal Shutdown Circuit (Thermal Protection)

This system has a built-in temperature protection circuit for the purpose of protecting the IC from thermal damage. As shown above, this must be used within the range of acceptable loss, but if the acceptable loss happens to be continuously exceeded, the chip temperature  $T_j$  increases, causing the temperature protection circuit to operate.

When the thermal shutdown circuit operates, the operation of the circuit is suspended. The circuit resumes operation immediately after the chip temperature  $T_j$  decreases, so the output repeats the ON and OFF states (Please refer to Figs.12 and 24 for the temperatures at which the temperature protection circuit operates).

There are cases in which the IC is destroyed due to thermal runaway when it is left in the overloaded state. Be sure to avoid leaving the IC in the overloaded state.

Reverse Current

In order to prevent the destruction of the IC when a reverse current flows through the IC, it is recommended that a diode be placed between the  $V_{cc}$  and  $V_o$  and a pathway be created so that the current can escape (Refer to Fig.36).

2) This IC is bipolar IC that has a P-board (substrate) and P+ isolation layer between each device, as shown in Fig.37. A P-N junction is formed between this P-layer and the N-layer of each device, and the P-N junction operates as a parasitic diode when the electric potential relationship is  $\text{GND} > \text{Terminal A}$ ,  $\text{GND} > \text{Terminal B}$ , while it operates as a parasitic transistor when the electric potential relationship is  $\text{Terminal B} > \text{GND} > \text{Terminal A}$ . Parasitic devices are intrinsic to the IC. The operation of parasitic devices induces mutual interference between circuits, causing malfunctions and eventually the destruction of the IC itself. It is necessary to be careful not to use the IC in ways that would cause parasitic elements to operate. For example, applying a voltage that is lower than the GND (P-board) to the input terminal.

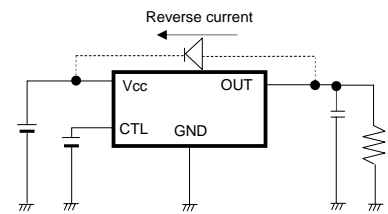

Fig. 36: Bypass diode

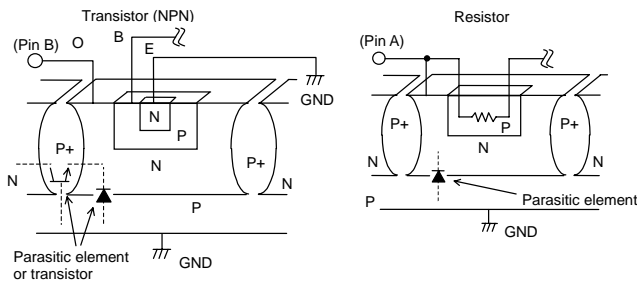
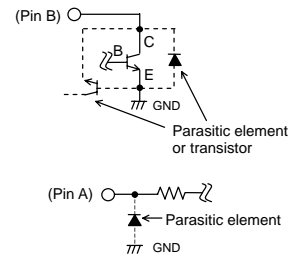

Fig. 37: Example of the basic structure of a bipolar IC



●Part Number Selection

**B A 0 0 C C 0 W H F P - E 2**

ROHM  
model name

Output  
voltage

Current capacity  
CC0 : 1A  
DD0 : 1A

Shutdown switch  
W : With switch  
None : Without  
switch

Package  
T : TO220-3,5  
F P : TO252-3,5  
HFP : HRP5  
CP : TO220CP

Package specification  
TR : Embossed taping(HRP5)  
E2 : Embossed taping(TO252-5,  
TO220CP)  
None : Tube container  
V5 :Foaming(V5 only)

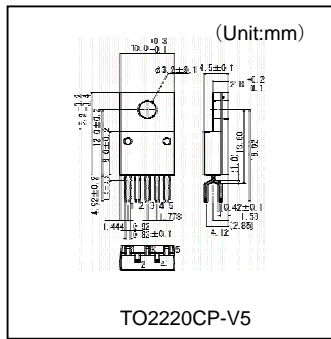
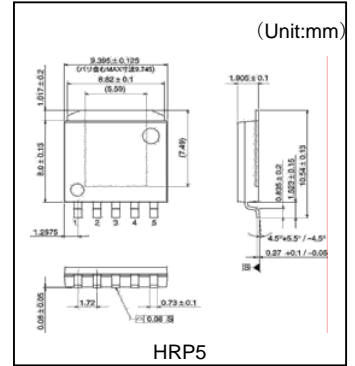
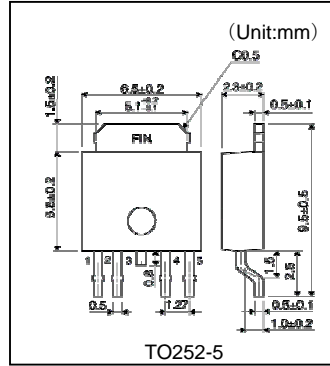
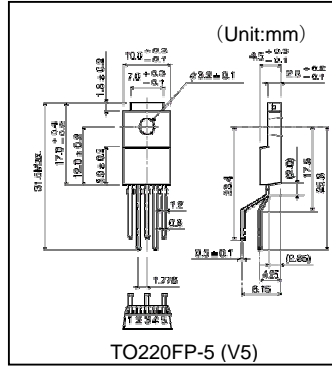
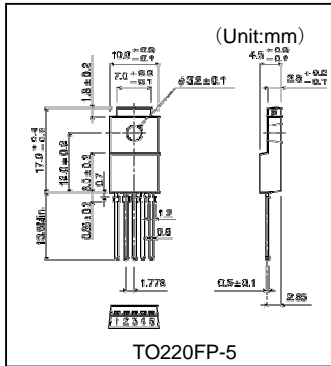

<Package Specification>TO220FP-5

Package Form	Container tube
Package Quantity	500pcs
Package Orientation	The product orientation in each container tube is constant.

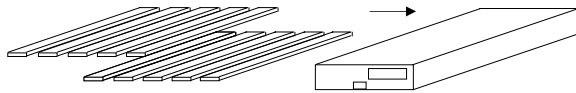

\*Please make orders in multiples of the package quantity.

<Package Specification>TO220FP-5 (V5)

Package Form	Container tube
Package Quantity	500pcs
Package Orientation	The product orientation in each container tube is constant.

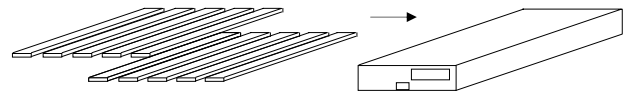

\*Please make orders in multiples of the package quantity.

<Tape and Reel information > TO252-3,5

Tape	Embossed taping
Quantity	2000pcs
Direction of feed	E2 (When the reek is held with the left hand and the tape is drawn out with the right hand, the No.1 pin of the product faces the lower left direction.)

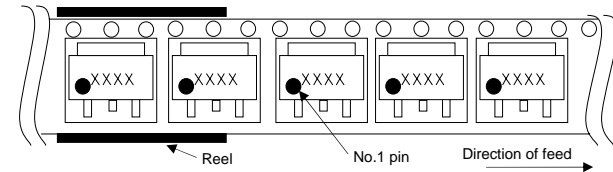

\*Please make orders in multiples of the package quantity.

<Tape and Reel information>HRP5

Tape	Embossed taping
Quantity	2000pcs
Direction of feed	TR (When the reek is held with the left hand and the tape is drawn out with the right hand, the No.1 pin of the product faces the upper right direction.)

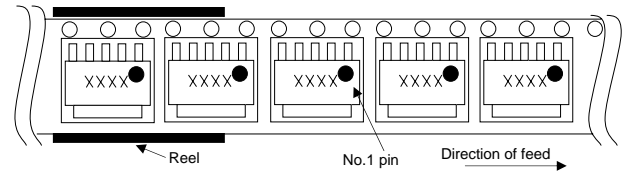

\*Please make orders in multiples of the package quantity.



### Notes

- No technical content pages of this document may be reproduced in any form or transmitted by any means without prior permission of ROHM CO.,LTD.
- The contents described herein are subject to change without notice. The specifications for the product described in this document are for reference only. Upon actual use, therefore, please request that specifications to be separately delivered.
- Application circuit diagrams and circuit constants contained herein are shown as examples of standard use and operation. Please pay careful attention to the peripheral conditions when designing circuits and deciding upon circuit constants in the set.
- Any data, including, but not limited to application circuit diagrams information, described herein are intended only as illustrations of such devices and not as the specifications for such devices. ROHM CO.,LTD. disclaims any warranty that any use of such devices shall be free from infringement of any third party's intellectual property rights or other proprietary rights, and further, assumes no liability of whatsoever nature in the event of any such infringement, or arising from or connected with or related to the use of such devices.
- Upon the sale of any such devices, other than for buyer's right to use such devices itself, resell or otherwise dispose of the same, no express or implied right or license to practice or commercially exploit any intellectual property rights or other proprietary rights owned or controlled by
- ROHM CO., LTD. is granted to any such buyer.
- Products listed in this document are no antiradiation design.

The products listed in this document are designed to be used with ordinary electronic equipment or devices (such as audio visual equipment, office-automation equipment, communications devices, electrical appliances and electronic toys).

Should you intend to use these products with equipment or devices which require an extremely high level of reliability and the malfunction of which would directly endanger human life (such as medical instruments, transportation equipment, aerospace machinery, nuclear-reactor controllers, fuel controllers and other safety devices), please be sure to consult with our sales representative in advance.

It is our top priority to supply products with the utmost quality and reliability. However, there is always a chance of failure due to unexpected factors. Therefore, please take into account the derating characteristics and allow for sufficient safety features, such as extra margin, anti-flammability, and fail-safe measures when designing in order to prevent possible accidents that may result in bodily harm or fire caused by component failure. ROHM cannot be held responsible for any damages arising from the use of the products under conditions out of the range of the specifications or due to non-compliance with the NOTES specified in this catalog.

Thank you for your accessing to ROHM product informations.

More detail product informations and catalogs are available, please contact your nearest sales office.

**ROHM** Customer Support System

THE AMERICAS / EUROPE / ASIA / JAPAN

[www.rohm.com](http://www.rohm.com)

Contact us : [webmaster@rohm.co.jp](mailto:webmaster@rohm.co.jp)