

TOSHIBA Bipolar Linear Integrated Circuit Silicon Monolithic

## TA78L05PF, TA78L06PF, TA78L07PF, TA78L08PF, TA78L09PF, TA78L10PF, TA78L12PF, TA78L15PF

5 V, 6 V, 7V, 8 V, 9 V, 10 V, 12 V, 15V

### 3-Terminal Positive Voltage Regulators

Housed in a very small and thin PS-8 package, the TA78L\*\*PF series of fixed-voltage monolithic integrated circuit voltage regulators is designed for a wide range of applications. One of these regulators can drive up to 0.15 A of output current. The series offers devices with low-output voltages: 5 V, 6 V, 7 V, 8 V, 9 V, 10 V, 12 V, and 15 V.

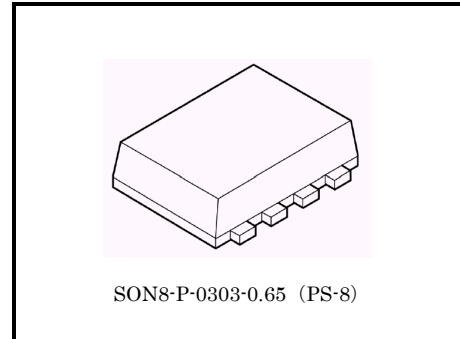

Weight: 0.08 g (typ.)

### Features

- Maximum output current: 0.15 A
- Output voltage accuracy:  $V_{OUT} \pm 4\%$  ( $@T_j = 25^\circ\text{C}$ )
- Protection function: overheating/overcurrent
- Package type: PS-8 is a flat lead, 8-pin package.

This is smaller and thinner than the previous PW-Mini, with a 47% decrease in height and a 54% decrease in mounting area.

- Lead-free products

### Pin Assignment/Marking

Product No.	Marking (5 digits)
TA78L05PF	78L05
TA78L06PF	78L06
TA78L07PF	78L07
TA78L08PF	78L08
TA78L09PF	78L09
TA78L10PF	78L10
TA78L12PF	78L12
TA78L15PF	78L15

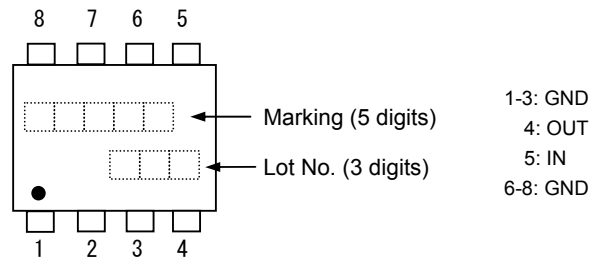

\*( $\bullet$ ) on the lower left of the marking indicates Pin 1.

\* Weekly code: (Three digits)

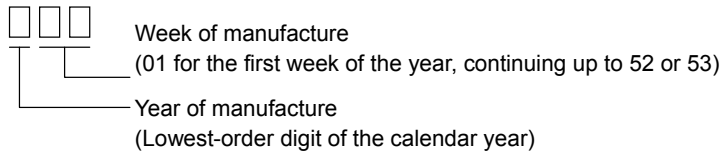

### How to Order

Product No.	Packing Type and Unit for Orders
TA78L**PF (TE85L,F)	Embossed-tape packing: 2000 (1 tape)

Note 1: In the actual product number, "\*\*\*" is replaced by the output voltage of the product.

## Block Diagram

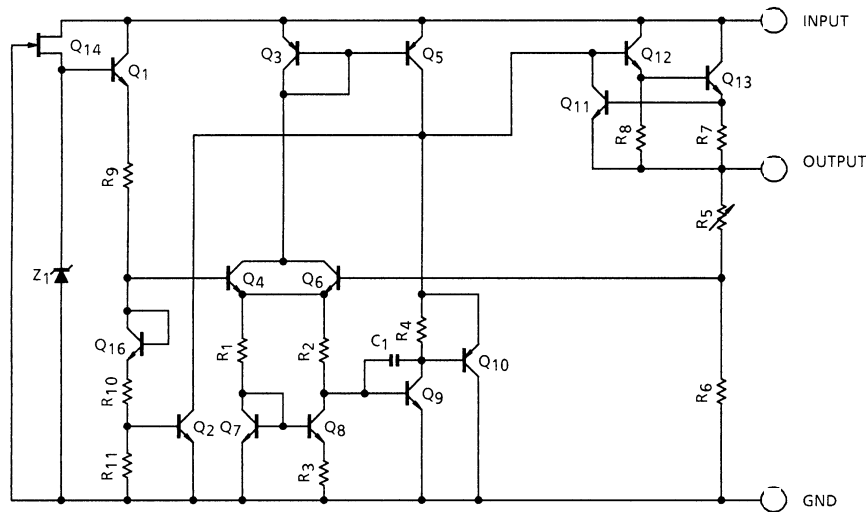

## Absolute Maximum Ratings (Ta = 25°C)

Characteristics	Symbol	Rating	Unit
Input voltage	$V_{IN}$	35	V
Output current	$I_{OUT}$	0.15	A
Operating temperature	$T_{opr}$	-30~85	°C
Junction temperature	$T_j$	150	°C
Storage temperature	$T_{stg}$	-55~150	°C
Power dissipation (Note 4a)	$P_D$	1.3	W
Power dissipation (Note 4b)	$P_D$	0.62	W

Note 2: Do not apply external current and voltage (including negative voltage) to pins other than those specified.

Note 3: Using continuously under heavy loads (e.g. the application of high temperature/current/voltage and the significant change in temperature, etc.) may cause this product to decrease in the reliability significantly even if the operating conditions (i.e. operating temperature/current/voltage, etc.) are within the absolute maximum ratings and the operating ranges.

Please design the appropriate reliability upon reviewing the Toshiba Semiconductor Reliability Handbook ("Handling Precautions"/Derating Concept and Methods) and individual reliability data (i.e. reliability test report and estimated failure rate, etc).

## Thermal resistance

Characteristics	Symbol	Rating	Unit
Thermal resistance (junction to ambient) (Note 4a)	$R_{th(j-a)}$	97	°C/W
Thermal resistance (junction to ambient) (Note 4b)	$R_{th(j-a)}$	202	°C/W

### Note 4:

(a) Device mounted on a glass-epoxy board

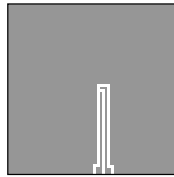

FR-4  
25.4 × 25.4 × 1.6  
Unit: (mm)  
Cu base thickness  
35 μm

(b) Device mounted on a glass-epoxy board

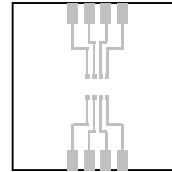

FR-4  
25.4 × 25.4 × 1.6  
Unit: (mm)  
Cu base thickness  
35 μm

## TA78L05PF

### Electrical Characteristics

( $V_{IN} = 10\text{ V}$ ,  $I_{OUT} = 40\text{ mA}$ ,  $C_{IN} = 0.33\text{ }\mu\text{F}$ ,  $C_{OUT} = 0.1\text{ }\mu\text{F}$ ,  $0^\circ\text{C} \leq T_j \leq 125^\circ\text{C}$ , unless otherwise specified)

Characteristics	Symbol	Test Circuit	Test Condition	Min	Typ.	Max	Unit	
Output voltage	$V_{OUT}$	1	$T_j = 25^\circ\text{C}$	4.8	5.0	5.2	V	
Line regulation	Reg-line	1	$T_j = 25^\circ\text{C}$	$7.0\text{ V} \leq V_{IN} \leq 20\text{ V}$	—	55	150	mV
				$8.0\text{ V} \leq V_{IN} \leq 20\text{ V}$	—	45	100	
Load regulation	Reg-load	1	$T_j = 25^\circ\text{C}$	$1.0\text{ mA} \leq I_{OUT} \leq 100\text{ mA}$	—	11	60	mV
				$1.0\text{ mA} \leq I_{OUT} \leq 40\text{ mA}$	—	5.0	30	
Output voltage	$V_{OUT}$	1	$T_j = 25^\circ\text{C}$	$7.0\text{ V} \leq V_{IN} \leq 20\text{ V}$ , $1.0\text{ mA} \leq I_{OUT} \leq 40\text{ mA}$	4.75	—	5.25	V
				$1.0\text{ mA} \leq I_{OUT} \leq 70\text{ mA}$	4.75	—	5.25	
Quiescent current	$I_B$	1	$T_j = 25^\circ\text{C}$	—	3.1	6.0	mA	
			$T_j = 125^\circ\text{C}$	—	—	5.5		
Quiescent current change	$\Delta I_B$	1	$T_j = 25^\circ\text{C}$	$8.0\text{ V} \leq V_{IN} \leq 20\text{ V}$	—	—	1.5	mA
				$1.0\text{ mA} \leq I_{OUT} \leq 40\text{ mA}$	—	—	0.1	
Output noise voltage	$V_{NO}$	2	$T_a = 25^\circ\text{C}$ , $10\text{ Hz} \leq f \leq 100\text{ kHz}$	—	40	—	$\mu\text{V}_{rms}$	
Ripple rejection ratio	R.R.	3	$f = 120\text{ Hz}$ , $8.0\text{ V} \leq V_{IN} \leq 18\text{ V}$ , $T_j = 25^\circ\text{C}$	41	49	—	dB	
Dropout voltage	$V_D$	1	$T_j = 25^\circ\text{C}$ , $I_{OUT} = 150\text{ mA}$	—	2.0	—	V	
Average temperature coefficient of output voltage	$T_{CVO}$	1	$I_{OUT} = 5\text{ mA}$	—	-0.6	—	$\text{mV}/^\circ\text{C}$	

## TA78L06PF

### Electrical Characteristics

( $V_{IN} = 11\text{ V}$ ,  $I_{OUT} = 40\text{ mA}$ ,  $C_{IN} = 0.33\text{ }\mu\text{F}$ ,  $C_{OUT} = 0.1\text{ }\mu\text{F}$ ,  $0^\circ\text{C} \leq T_j \leq 125^\circ\text{C}$ , unless otherwise specified)

Characteristics	Symbol	Test Circuit	Test Condition	Min	Typ.	Max	Unit	
Output voltage	$V_{OUT}$	1	$T_j = 25^\circ\text{C}$	5.76	6.0	6.24	V	
Line regulation	Reg-line	1	$T_j = 25^\circ\text{C}$	$8.1\text{ V} \leq V_{IN} \leq 21\text{ V}$	—	50	150	mV
				$9.0\text{ V} \leq V_{IN} \leq 21\text{ V}$	—	45	110	
Load regulation	Reg-load	1	$T_j = 25^\circ\text{C}$	$1.0\text{ mA} \leq I_{OUT} \leq 100\text{ mA}$	—	12	70	mV
				$1.0\text{ mA} \leq I_{OUT} \leq 40\text{ mA}$	—	5.5	35	
Output voltage	$V_{OUT}$	1	$T_j = 25^\circ\text{C}$	$8.1\text{ V} \leq V_{IN} \leq 21\text{ V}$ , $1.0\text{ mA} \leq I_{OUT} \leq 40\text{ mA}$	5.7	—	6.3	V
				$1.0\text{ mA} \leq I_{OUT} \leq 70\text{ mA}$	5.7	—	6.3	
Quiescent current	$I_B$	1	$T_j = 25^\circ\text{C}$	—	3.1	6.0	mA	
			$T_j = 125^\circ\text{C}$	—	—	5.5		
Quiescent current change	$\Delta I_B$	1	$T_j = 25^\circ\text{C}$	$9.0\text{ V} \leq V_{IN} \leq 20\text{ V}$	—	—	1.5	mA
				$1.0\text{ mA} \leq I_{OUT} \leq 40\text{ mA}$	—	—	0.1	
Output noise voltage	$V_{NO}$	2	$T_a = 25^\circ\text{C}$ , $10\text{ Hz} \leq f \leq 100\text{ kHz}$	—	40	—	$\mu\text{V}_{rms}$	
Ripple rejection ratio	R.R.	3	$f = 120\text{ Hz}$ , $9.0\text{ V} \leq V_{IN} \leq 19\text{ V}$ , $T_j = 25^\circ\text{C}$	39	47	—	dB	
Dropout voltage	$V_D$	1	$T_j = 25^\circ\text{C}$ , $I_{OUT} = 150\text{ mA}$	—	2.0	—	V	
Average temperature coefficient of output voltage	$T_{CVO}$	1	$I_{OUT} = 5\text{ mA}$	—	-0.7	—	$\text{mV}/^\circ\text{C}$	

## TA78L07PF

### Electrical Characteristics

( $V_{IN} = 12\text{ V}$ ,  $I_{OUT} = 40\text{ mA}$ ,  $C_{IN} = 0.33\text{ }\mu\text{F}$ ,  $C_{OUT} = 0.1\text{ }\mu\text{F}$ ,  $0^\circ\text{C} \leq T_j \leq 125^\circ\text{C}$ , unless otherwise specified)

Characteristics	Symbol	Test Circuit	Test Condition	Min	Typ.	Max	Unit	
Output voltage	$V_{OUT}$	1	$T_j = 25^\circ\text{C}$	6.72	7.0	7.28	V	
Line regulation	Reg-line	1	$T_j = 25^\circ\text{C}$	$9.2\text{ V} \leq V_{IN} \leq 22\text{ V}$	—	50	160	mV
				$10\text{ V} \leq V_{IN} \leq 22\text{ V}$	—	45	115	
Load regulation	Reg-load	1	$T_j = 25^\circ\text{C}$	$1.0\text{ mA} \leq I_{OUT} \leq 100\text{ mA}$	—	13	75	mV
				$1.0\text{ mA} \leq I_{OUT} \leq 40\text{ mA}$	—	6.0	40	
Output voltage	$V_{OUT}$	1	$T_j = 25^\circ\text{C}$	$9.2\text{ V} \leq V_{IN} \leq 22\text{ V}$ , $1.0\text{ mA} \leq I_{OUT} \leq 40\text{ mA}$	6.65	—	7.35	V
				$1.0\text{ mA} \leq I_{OUT} \leq 70\text{ mA}$	6.65	—	7.35	
Quiescent current	$I_B$	1	$T_j = 25^\circ\text{C}$	—	3.1	6.5	mA	
			$T_j = 125^\circ\text{C}$	—	—	6.0		
Quiescent current change	$\Delta I_B$	1	$T_j = 25^\circ\text{C}$	$10\text{ V} \leq V_{IN} \leq 22\text{ V}$	—	—	1.5	mA
				$1.0\text{ mA} \leq I_{OUT} \leq 40\text{ mA}$	—	—	0.1	
Output noise voltage	$V_{NO}$	2	$T_a = 25^\circ\text{C}$ , $10\text{ Hz} \leq f \leq 100\text{ kHz}$	—	50	—	$\mu\text{V}_{rms}$	
Ripple rejection ratio	R.R.	3	$f = 120\text{ Hz}$ , $10\text{ V} \leq V_{IN} \leq 20\text{ V}$ , $T_j = 25^\circ\text{C}$	37	46	—	dB	
Dropout voltage	$V_D$	1	$T_j = 25^\circ\text{C}$ , $I_{OUT} = 150\text{ mA}$	—	2.0	—	V	
Average temperature coefficient of output voltage	$T_{CVO}$	1	$I_{OUT} = 5\text{ mA}$	—	-0.75	—	$\text{mV}/^\circ\text{C}$	

## TA78L08PF

### Electrical Characteristics

( $V_{IN} = 14\text{ V}$ ,  $I_{OUT} = 40\text{ mA}$ ,  $C_{IN} = 0.33\text{ }\mu\text{F}$ ,  $C_{OUT} = 0.1\text{ }\mu\text{F}$ ,  $0^\circ\text{C} \leq T_j \leq 125^\circ\text{C}$ , unless otherwise specified)

Characteristics	Symbol	Test Circuit	Test Condition	Min	Typ.	Max	Unit	
Output voltage	$V_{OUT}$	1	$T_j = 25^\circ\text{C}$	7.7	8.0	8.3	V	
Line regulation	Reg-line	1	$T_j = 25^\circ\text{C}$	$10.5\text{ V} \leq V_{IN} \leq 23\text{ V}$	—	20	175	mV
				$11\text{ V} \leq V_{IN} \leq 23\text{ V}$	—	12	125	
Load regulation	Reg-load	1	$T_j = 25^\circ\text{C}$	$1.0\text{ mA} \leq I_{OUT} \leq 100\text{ mA}$	—	15	80	mV
				$1.0\text{ mA} \leq I_{OUT} \leq 40\text{ mA}$	—	7.0	40	
Output voltage	$V_{OUT}$	1	$T_j = 25^\circ\text{C}$	$10.5\text{ V} \leq V_{IN} \leq 23\text{ V}$ , $1.0\text{ mA} \leq I_{OUT} \leq 40\text{ mA}$	7.6	—	8.4	V
				$1.0\text{ mA} \leq I_{OUT} \leq 70\text{ mA}$	7.6	—	8.4	
Quiescent current	$I_B$	1	$T_j = 25^\circ\text{C}$	—	3.1	6.5	mA	
			$T_j = 125^\circ\text{C}$	—	—	6.0		
Quiescent current change	$\Delta I_B$	1	$T_j = 25^\circ\text{C}$	$11\text{ V} \leq V_{IN} \leq 23\text{ V}$	—	—	1.5	mA
				$1.0\text{ mA} \leq I_{OUT} \leq 40\text{ mA}$	—	—	0.1	
Output noise voltage	$V_{NO}$	2	$T_a = 25^\circ\text{C}$ , $10\text{ Hz} \leq f \leq 100\text{ kHz}$	—	60	—	$\mu\text{V}_{rms}$	
Ripple rejection ratio	R.R.	3	$f = 120\text{ Hz}$ , $12\text{ V} \leq V_{IN} \leq 23\text{ V}$ , $T_j = 25^\circ\text{C}$	37	45	—	dB	
Dropout voltage	$V_D$	1	$T_j = 25^\circ\text{C}$ , $I_{OUT} = 150\text{ mA}$	—	2.0	—	V	
Average temperature coefficient of output voltage	$T_{CVO}$	1	$I_{OUT} = 5\text{ mA}$	—	-0.8	—	$\text{mV}/^\circ\text{C}$	

## TA78L09PF

### Electrical Characteristics

( $V_{IN} = 15\text{ V}$ ,  $I_{OUT} = 40\text{ mA}$ ,  $C_{IN} = 0.33\text{ }\mu\text{F}$ ,  $C_{OUT} = 0.1\text{ }\mu\text{F}$ ,  $0^\circ\text{C} \leq T_j \leq 125^\circ\text{C}$ , unless otherwise specified)

Characteristics	Symbol	Test Circuit	Test Condition	Min	Typ.	Max	Unit	
Output voltage	$V_{OUT}$	1	$T_j = 25^\circ\text{C}$	8.64	9.0	9.36	V	
Line regulation	Reg-line	1	$T_j = 25^\circ\text{C}$	$11.4\text{ V} \leq V_{IN} \leq 24\text{ V}$	—	80	200	mV
				$12\text{ V} \leq V_{IN} \leq 24\text{ V}$	—	20	160	
Load regulation	Reg-load	1	$T_j = 25^\circ\text{C}$	$1.0\text{ mA} \leq I_{OUT} \leq 100\text{ mA}$	—	17	90	mV
				$1.0\text{ mA} \leq I_{OUT} \leq 40\text{ mA}$	—	8.0	45	
Output voltage	$V_{OUT}$	1	$T_j = 25^\circ\text{C}$	$11.4\text{ V} \leq V_{IN} \leq 24\text{ V}$ , $1.0\text{ mA} \leq I_{OUT} \leq 40\text{ mA}$	8.55	—	9.45	V
				$1.0\text{ mA} \leq I_{OUT} \leq 70\text{ mA}$	8.55	—	9.45	
Quiescent current	$I_B$	1	$T_j = 25^\circ\text{C}$	—	3.2	6.5	mA	
			$T_j = 125^\circ\text{C}$	—	—	6.0		
Quiescent current change	$\Delta I_B$	1	$T_j = 25^\circ\text{C}$	$12\text{ V} \leq V_{IN} \leq 24\text{ V}$	—	—	1.5	mA
				$1.0\text{ mA} \leq I_{OUT} \leq 40\text{ mA}$	—	—	0.1	
Output noise voltage	$V_{NO}$	2	$T_a = 25^\circ\text{C}$ , $10\text{ Hz} \leq f \leq 100\text{ kHz}$	—	65	—	$\mu\text{V}_{rms}$	
Ripple rejection ratio	R.R.	3	$f = 120\text{ Hz}$ , $12\text{ V} \leq V_{IN} \leq 24\text{ V}$ , $T_j = 25^\circ\text{C}$	36	44	—	dB	
Dropout voltage	$V_D$	1	$T_j = 25^\circ\text{C}$ , $I_{OUT} = 150\text{ mA}$	—	2.0	—	V	
Average temperature coefficient of output voltage	$T_{CVO}$	1	$I_{OUT} = 5\text{ mA}$	—	-0.85	—	$\text{mV}/^\circ\text{C}$	

## TA78L10PF

### Electrical Characteristics

( $V_{IN} = 16\text{ V}$ ,  $I_{OUT} = 40\text{ mA}$ ,  $C_{IN} = 0.33\text{ }\mu\text{F}$ ,  $C_{OUT} = 0.1\text{ }\mu\text{F}$ ,  $0^\circ\text{C} \leq T_j \leq 125^\circ\text{C}$ , unless otherwise specified)

Characteristics	Symbol	Test Circuit	Test Condition	Min	Typ.	Max	Unit	
Output voltage	$V_{OUT}$	1	$T_j = 25^\circ\text{C}$	9.6	10	10.4	V	
Line regulation	Reg-line	1	$T_j = 25^\circ\text{C}$	$12.5\text{ V} \leq V_{IN} \leq 25\text{ V}$	—	80	230	mV
				$13\text{ V} \leq V_{IN} \leq 25\text{ V}$	—	30	170	
Load regulation	Reg-load	1	$T_j = 25^\circ\text{C}$	$1.0\text{ mA} \leq I_{OUT} \leq 100\text{ mA}$	—	18	90	mV
				$1.0\text{ mA} \leq I_{OUT} \leq 40\text{ mA}$	—	8.5	45	
Output voltage	$V_{OUT}$	1	$T_j = 25^\circ\text{C}$	$12.5\text{ V} \leq V_{IN} \leq 25\text{ V}$ , $1.0\text{ mA} \leq I_{OUT} \leq 40\text{ mA}$	9.5	—	10.5	V
				$1.0\text{ mA} \leq I_{OUT} \leq 70\text{ mA}$	9.5	—	10.5	
Quiescent current	$I_B$	1	$T_j = 25^\circ\text{C}$	—	3.2	6.5	mA	
			$T_j = 125^\circ\text{C}$	—	—	6.0		
Quiescent current change	$\Delta I_B$	1	$T_j = 25^\circ\text{C}$	$13\text{ V} \leq V_{IN} \leq 25\text{ V}$	—	—	1.5	mA
				$1.0\text{ mA} \leq I_{OUT} \leq 40\text{ mA}$	—	—	0.1	
Output noise voltage	$V_{NO}$	2	$T_a = 25^\circ\text{C}$ , $10\text{ Hz} \leq f \leq 100\text{ kHz}$	—	70	—	$\mu\text{V}_{rms}$	
Ripple rejection ratio	R.R.	3	$f = 120\text{ Hz}$ , $13\text{ V} \leq V_{IN} \leq 24\text{ V}$ , $T_j = 25^\circ\text{C}$	36	43	—	dB	
Dropout voltage	$V_D$	1	$T_j = 25^\circ\text{C}$ , $I_{OUT} = 150\text{ mA}$	—	2.0	—	V	
Average temperature coefficient of output voltage	$T_{CVO}$	1	$I_{OUT} = 5\text{ mA}$	—	-0.9	—	$\text{mV}/^\circ\text{C}$	

## TA78L12PF

### Electrical Characteristics

( $V_{IN} = 19\text{ V}$ ,  $I_{OUT} = 40\text{ mA}$ ,  $C_{IN} = 0.33\text{ }\mu\text{F}$ ,  $C_{OUT} = 0.1\text{ }\mu\text{F}$ ,  $0^\circ\text{C} \leq T_j \leq 125^\circ\text{C}$ , unless otherwise specified)

Characteristics	Symbol	Test Circuit	Test Condition	Min	Typ.	Max	Unit	
Output voltage	$V_{OUT}$	1	$T_j = 25^\circ\text{C}$	11.52	12	12.48	V	
Line regulation	Reg-line	1	$T_j = 25^\circ\text{C}$	$14.5\text{ V} \leq V_{IN} \leq 27\text{ V}$	—	120	250	mV
				$16\text{ V} \leq V_{IN} \leq 27\text{ V}$	—	100	200	
Load regulation	Reg-load	1	$T_j = 25^\circ\text{C}$	$1.0\text{ mA} \leq I_{OUT} \leq 100\text{ mA}$	—	20	100	mV
				$1.0\text{ mA} \leq I_{OUT} \leq 40\text{ mA}$	—	10	50	
Output voltage	$V_{OUT}$	1	$T_j = 25^\circ\text{C}$	$14.5\text{ V} \leq V_{IN} \leq 27\text{ V}$ , $1.0\text{ mA} \leq I_{OUT} \leq 40\text{ mA}$	11.4	—	12.6	V
				$1.0\text{ mA} \leq I_{OUT} \leq 70\text{ mA}$	11.4	—	12.6	
Quiescent current	$I_B$	1	$T_j = 25^\circ\text{C}$	—	3.2	6.5	mA	
			$T_j = 125^\circ\text{C}$	—	—	6.0		
Quiescent current change	$\Delta I_B$	1	$T_j = 25^\circ\text{C}$	$16\text{ V} \leq V_{IN} \leq 27\text{ V}$	—	—	1.5	mA
				$1.0\text{ mA} \leq I_{OUT} \leq 40\text{ mA}$	—	—	0.1	
Output noise voltage	$V_{NO}$	2	$T_a = 25^\circ\text{C}$ , $10\text{ Hz} \leq f \leq 100\text{ kHz}$	—	80	—	$\mu\text{V}_{rms}$	
Ripple rejection ratio	R.R.	3	$f = 120\text{ Hz}$ , $15\text{ V} \leq V_{IN} \leq 25\text{ V}$ , $T_j = 25^\circ\text{C}$	36	41	—	dB	
Dropout voltage	$V_D$	1	$T_j = 25^\circ\text{C}$ , $I_{OUT} = 150\text{ mA}$	—	2.0	—	V	
Average temperature coefficient of output voltage	$T_{CVO}$	1	$I_{OUT} = 5\text{ mA}$	—	-1.0	—	$\text{mV}/^\circ\text{C}$	

## TA78L15PF

### Electrical Characteristics

( $V_{IN} = 23\text{ V}$ ,  $I_{OUT} = 40\text{ mA}$ ,  $C_{IN} = 0.33\text{ }\mu\text{F}$ ,  $C_{OUT} = 0.1\text{ }\mu\text{F}$ ,  $0^\circ\text{C} \leq T_j \leq 125^\circ\text{C}$ , unless otherwise specified)

Characteristics	Symbol	Test Circuit	Test Condition	Min	Typ.	Max	Unit	
Output voltage	$V_{OUT}$	1	$T_j = 25^\circ\text{C}$	14.4	15	15.6	V	
Line regulation	Reg-line	1	$T_j = 25^\circ\text{C}$	$17.5\text{ V} \leq V_{IN} \leq 30\text{ V}$	—	130	300	mV
				$20\text{ V} \leq V_{IN} \leq 30\text{ V}$	—	110	250	
Load regulation	Reg-load	1	$T_j = 25^\circ\text{C}$	$1.0\text{ mA} \leq I_{OUT} \leq 100\text{ mA}$	—	25	150	mV
				$1.0\text{ mA} \leq I_{OUT} \leq 40\text{ mA}$	—	12	75	
Output voltage	$V_{OUT}$	1	$T_j = 25^\circ\text{C}$	$17.5\text{ V} \leq V_{IN} \leq 30\text{ V}$ , $1.0\text{ mA} \leq I_{OUT} \leq 40\text{ mA}$	14.25	—	15.75	V
				$1.0\text{ mA} \leq I_{OUT} \leq 70\text{ mA}$	14.25	—	15.75	
Quiescent current	$I_B$	1	$T_j = 25^\circ\text{C}$	—	3.3	6.5	mA	
			$T_j = 125^\circ\text{C}$	—	—	6.0		
Quiescent current change	$\Delta I_B$	1	$T_j = 25^\circ\text{C}$	$20\text{ V} \leq V_{IN} \leq 30\text{ V}$	—	—	1.5	mA
				$1.0\text{ mA} \leq I_{OUT} \leq 40\text{ mA}$	—	—	0.1	
Output noise voltage	$V_{NO}$	2	$T_a = 25^\circ\text{C}$ , $10\text{ Hz} \leq f \leq 100\text{ kHz}$	—	90	—	$\mu\text{V}_{rms}$	
Ripple rejection ratio	R.R.	3	$f = 120\text{ Hz}$ , $18.5\text{ V} \leq V_{IN} \leq 28.5\text{ V}$ , $T_j = 25^\circ\text{C}$	34	40	—	dB	
Dropout voltage	$V_D$	1	$T_j = 25^\circ\text{C}$ , $I_{OUT} = 150\text{ mA}$	—	2.0	—	V	
Average temperature coefficient of output voltage	$T_{CVO}$	1	$I_{OUT} = 5\text{ mA}$	—	-1.3	—	$\text{mV}/^\circ\text{C}$	

## Electrical Characteristics for All Products

Generally, the characteristics of power supply ICs change according to temperature fluctuations. The specification  $T_j = 25^\circ\text{C}$  is based on a state where temperature increase has no effect (assuming no fluctuation in the characteristics) as ascertained by pulse tests.

### Test Circuit 1/Standard Application

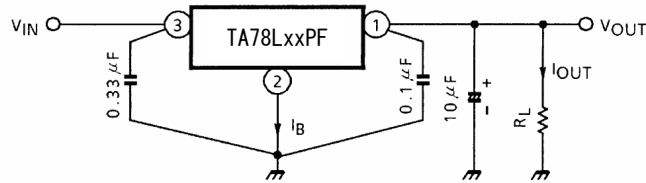

Use capacitors to connect the input terminal and GND and the output terminal and GND. The capacitances should be determined experimentally. In particular, adequate investigation should be made to ensure there is no problem even in high or low temperatures.

### Test Circuit 2

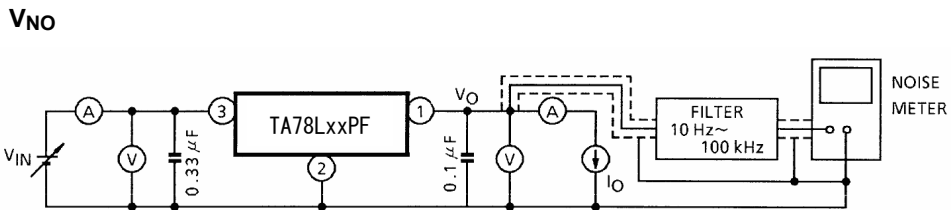

### Test Circuit 3

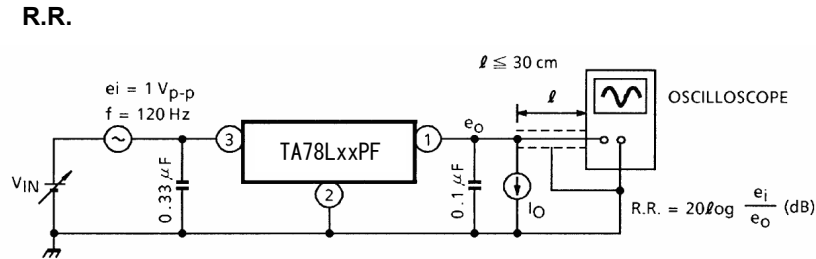



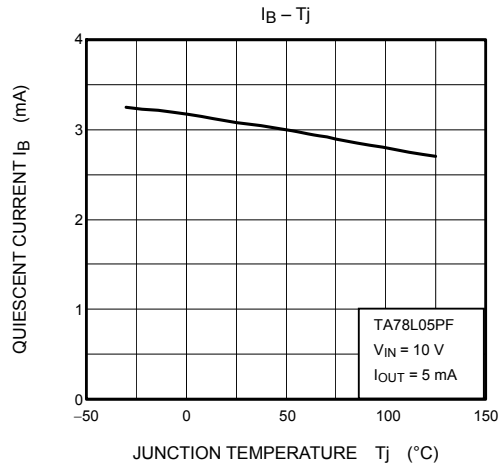
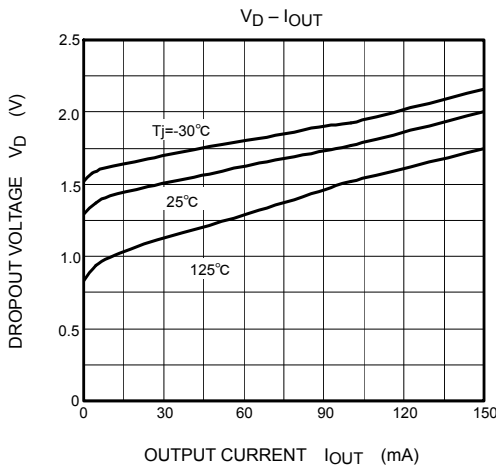
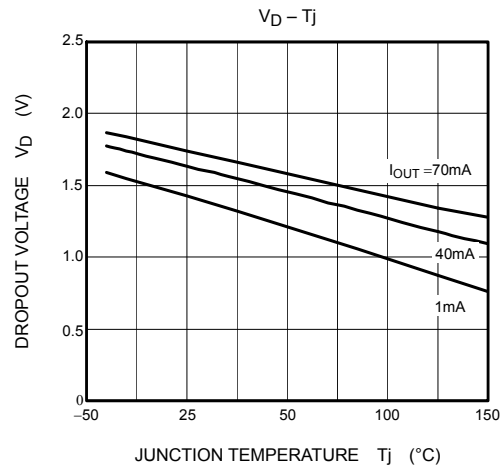
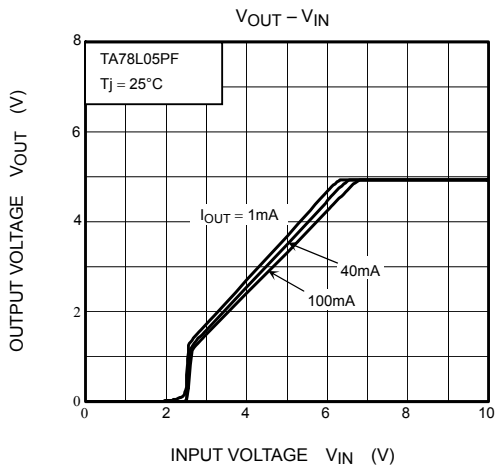
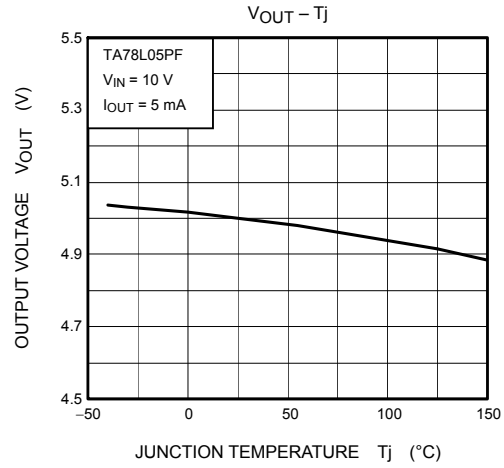
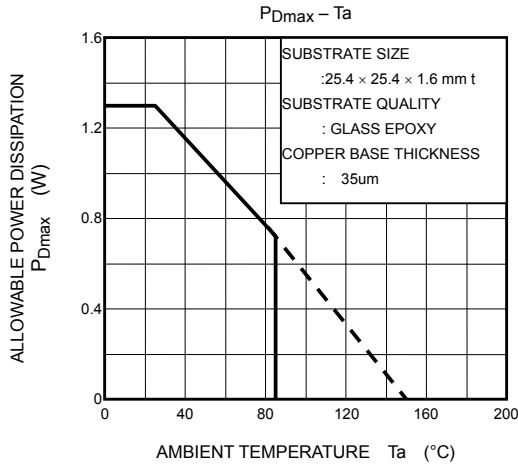

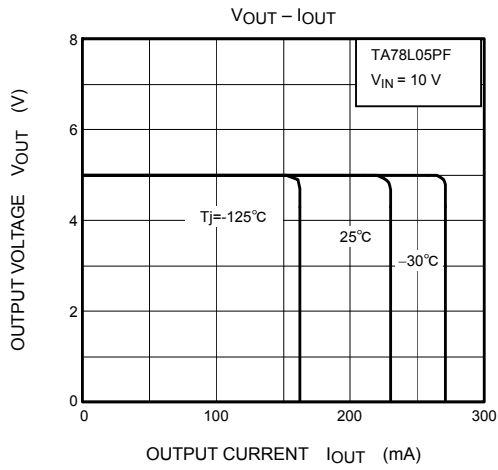
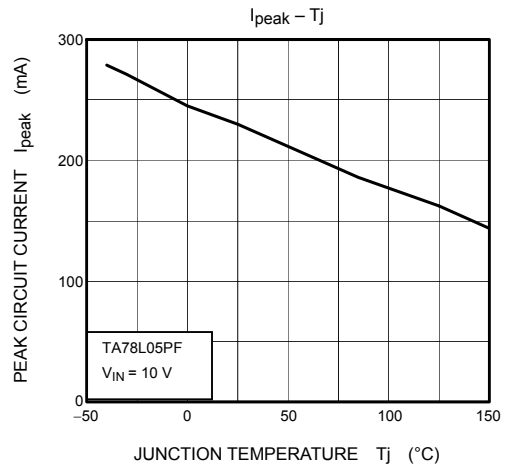
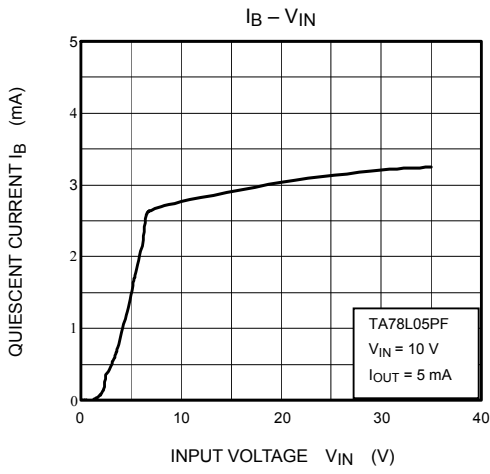

## Precautions for Use

If a high voltage in excess of the output voltage (typ. value) of the IC is applied to the output terminal of the IC, the IC may be destroyed. To prevent such application of excessive voltage, connect a Zener diode between the output terminal and GND.

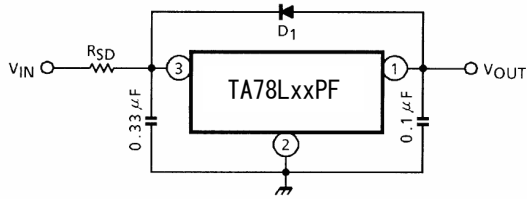

- D<sub>1</sub>** : IC protective diode  
 When surge voltage is applied to IC output terminal or  $V_{IN} < V_{OUT}$  at the time of power ON/OFF, always connect the high speed swithing diode D<sub>1</sub>.
- R<sub>SD</sub>** : Power limiting resistor  
 If  $V_{IN}$  is too high, always connect R<sub>SD</sub> in order to reduce power consumption of IC.

## Package Dimensions

SON8-P-0303-0.65 (PS-8)

Unit: mm

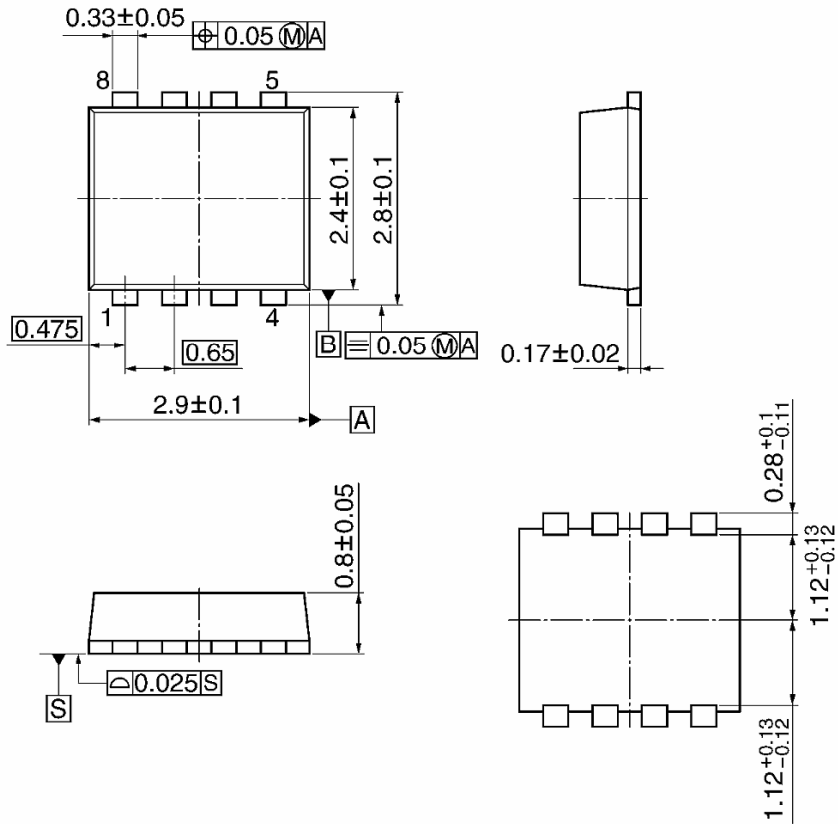

Weight: 0.08 g (typ.)

**RESTRICTIONS ON PRODUCT USE**

20070701-EN

- The information contained herein is subject to change without notice.
- TOSHIBA is continually working to improve the quality and reliability of its products. Nevertheless, semiconductor devices in general can malfunction or fail due to their inherent electrical sensitivity and vulnerability to physical stress. It is the responsibility of the buyer, when utilizing TOSHIBA products, to comply with the standards of safety in making a safe design for the entire system, and to avoid situations in which a malfunction or failure of such TOSHIBA products could cause loss of human life, bodily injury or damage to property.  
In developing your designs, please ensure that TOSHIBA products are used within specified operating ranges as set forth in the most recent TOSHIBA products specifications. Also, please keep in mind the precautions and conditions set forth in the "Handling Guide for Semiconductor Devices," or "TOSHIBA Semiconductor Reliability Handbook" etc.
- The TOSHIBA products listed in this document are intended for usage in general electronics applications (computer, personal equipment, office equipment, measuring equipment, industrial robotics, domestic appliances, etc.). These TOSHIBA products are neither intended nor warranted for usage in equipment that requires extraordinarily high quality and/or reliability or a malfunction or failure of which may cause loss of human life or bodily injury ("Unintended Usage"). Unintended Usage include atomic energy control instruments, airplane or spaceship instruments, transportation instruments, traffic signal instruments, combustion control instruments, medical instruments, all types of safety devices, etc.. Unintended Usage of TOSHIBA products listed in this document shall be made at the customer's own risk.
- The products described in this document shall not be used or embedded to any downstream products of which manufacture, use and/or sale are prohibited under any applicable laws and regulations.
- The information contained herein is presented only as a guide for the applications of our products. No responsibility is assumed by TOSHIBA for any infringements of patents or other rights of the third parties which may result from its use. No license is granted by implication or otherwise under any patents or other rights of TOSHIBA or the third parties.
- Please contact your sales representative for product-by-product details in this document regarding RoHS compatibility. Please use these products in this document in compliance with all applicable laws and regulations that regulate the inclusion or use of controlled substances. Toshiba assumes no liability for damage or losses occurring as a result of noncompliance with applicable laws and regulations.