

PQxxxRDA1SZH Series

TO-220 Type, 1A Output Low Power-Loss Voltage Regulators

■ Features

1. Low power-loss
Dropout voltage: MAX.0.5V
2. Output current: 1A
3. Low dissipation current
(Dissipation current at no load: MAX. 8mA
Output OFF-state dissipation current: MAX.5μA)
4. Built-in ON/OFF function
5. Built-in overcurrent and overheat protection functions
6. Built-in ASO protect function
7. RoHS directive compliant

■ Applications

1. Power supplies for various electronic equipment such as AV,OA

■ Model Line-up

Output voltage	Model No.	Output voltage	Model No.
3.3V	PQ033RDA1SZH	9.0V	PQ090RDA1SZH
5.0V	PQ050RDA1SZH	12.0V	PQ120RDA1SZH
8.0V	PQ080RDA1SZH		

■ Absolute Maximum Ratings

(Ta=25°C)

Parameter	Symbol	Rating	Unit
*1 Input voltage	V _{IN}	24	V
*1 ON/OFF control terminal voltage	V _C	24	V
Output current	I _O	1.0	A
*2 Power dissipation	P _{D1}	1.4	W
	P _{D2}	15	
*3 Junction temperature	T _j	150	°C
Operating temperature	T _{opr}	-30 to +85	°C
Storage temperature	T _{stg}	-40 to +150	°C
Soldering temperature	T _{sol}	260(10s)	°C

*1 All are open except GND and applicable terminals.

*2 P_{D1}: No heat sink, P_{D2}: With infinite heat sink.

*3 Overheat protection may operate at T_j=125°C to 150°C

■ Outline Dimensions

(Unit : mm)

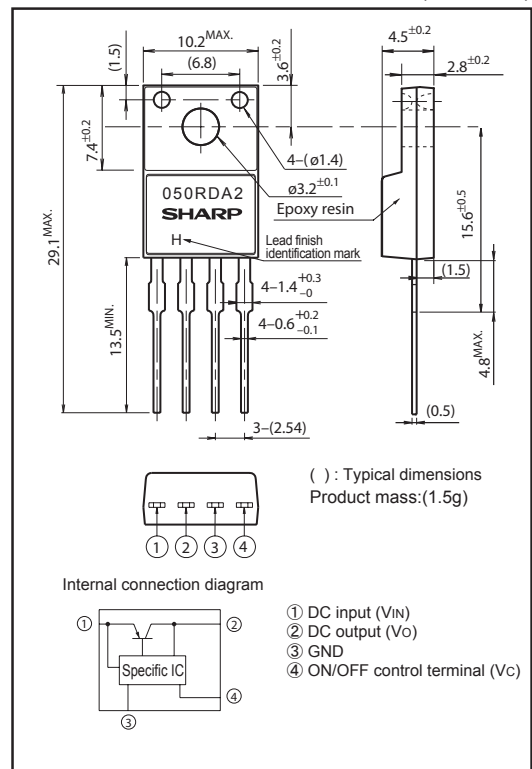

Lead finish: Lead-free solder plating
(Composition: Sn2Cu)

Notice The content of data sheet is subject to change without prior notice.

In the absence of confirmation by device specification sheets, SHARP takes no responsibility for any defects that may occur in equipment using any SHARP devices shown in catalogs, data books, etc. Contact SHARP in order to obtain the latest device specification sheets before using any SHARP device.

Electrical Characteristics

(Unless otherwise specified, condition shall be $V_{IN}=V_O(TYP.)+2V, I_O=0.5A, V_C=2.7V, T_a=25^\circ C$)

Parameter	Symbol	Conditions	MIN.	TYP.	MAX.	Unit
Output voltage	V_O	-	Refer to the table below			V
Load regulation	RegL	$I_O=5mA$ to $1A$	-	0.1	2.0	%
Line regulation	Regl	$V_{IN}=V_O(TYP.)+1V$ to $V_O(TYP.)+7V, I_O=5mA$	-	0.5	2.5	%
Temperature coefficient of output voltage	$T_C V_O$	$T_J=0$ to $+125^\circ C, I_O=5mA$	-	± 0.02	-	$\%/^\circ C$
Ripple rejection	RR	-	-	55	-	dB
Dropout voltage	V_{I-O}	^{※4} $I_O=0.5A$	-	-	0.5	V
^{※5} ON-state voltage for control	$V_{C(ON)}$	-	2.0	-	-	V
ON-state current for control	$I_{C(ON)}$	$V_C=2.7V$	-	-	200	μA
OFF-state voltage for control	$V_{C(OFF)}$	-	-	-	0.8	V
OFF-state current for control	$I_{C(OFF)}$	$V_C=0.4V$	-	-	-2	μA
Quiescent current	I_q	$I_O=0A$	-	-	8	mA
Output OFF-state dissipation current	I_{qs}	$I_O=0A, V_C=0.4V$	-	-	5	μA

^{※4} $V_{IN}=3.8V$ (PQ033RDA1SZH). Input voltage shall be the value when output voltage is 95% in comparison with the initial value (PQ050RDA1SZH, PQ080RDA1SZH, PQ090RDA1SZH, PQ120RDA1SZH).

^{※5} In case of opening control terminal ④, output voltage turns off.

Table.1 Output Voltage Line-up

Model No.	Symbol	Conditions	MIN.	TYP.	MAX.	Unit
PQ033RDA1SZH	V_O	$V_{IN}=V_O(TYP.)+2V, I_O=0.5A, V_C=2.7V, T_a=25^\circ C$	3.201	3.3	3.399	V
PQ050RDA1SZH			4.85	5.0	5.15	
PQ080RDA1SZH			7.76	8.0	8.24	
PQ090RDA1SZH			8.73	9.0	9.27	
PQ120RDA1SZH			11.64	12.0	12.36	

Fig.1 Test Circuit

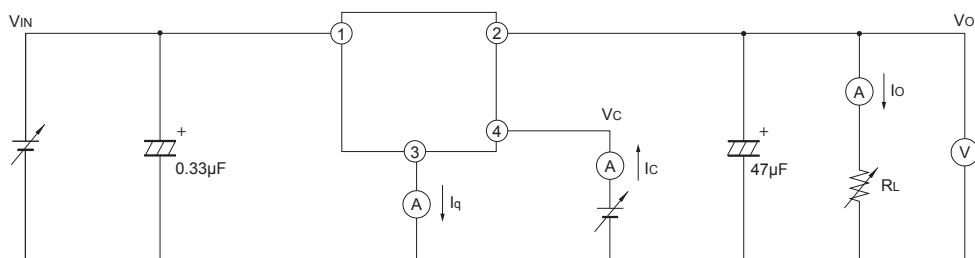

Fig.2 Test Circuit of Ripple Rejection

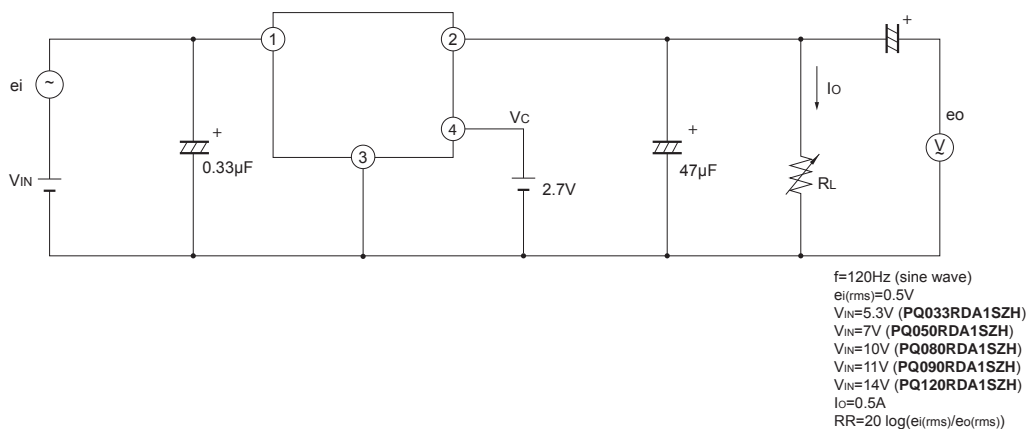
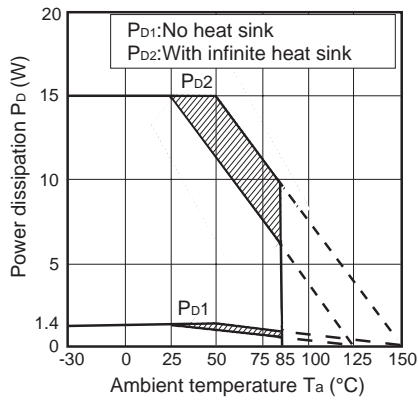

Fig.3 Power Dissipation vs. Ambient Temperature



Note) Oblique line portion:Overheat protection may operate in this area.

Fig.4 Overcurrent Protection Characteristics (PQ030RDA1SZH)

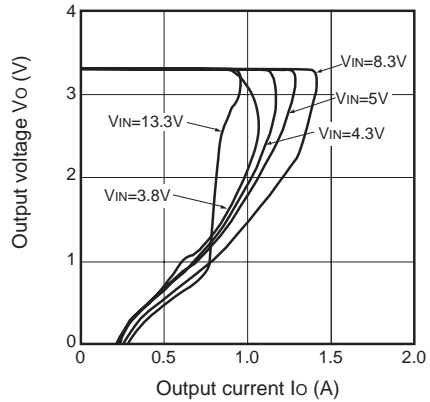

Fig.5 Overcurrent Protection Characteristics (PQ050RDA1SZH)

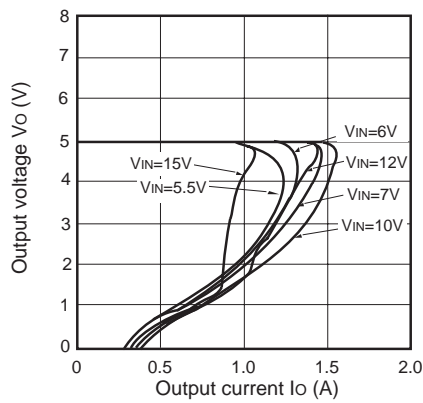

Fig.6 Overcurrent Protection Characteristics (PQ080RDA1SZH)

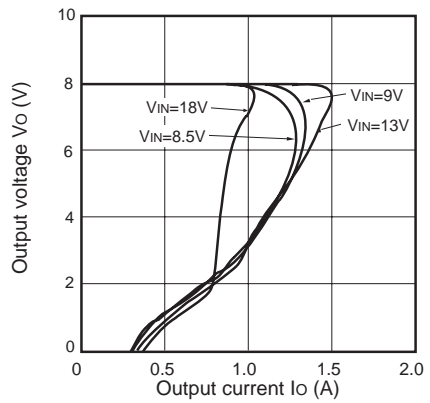

Fig.7 Overcurrent Protection Characteristics (PQ090RDA1SZH)

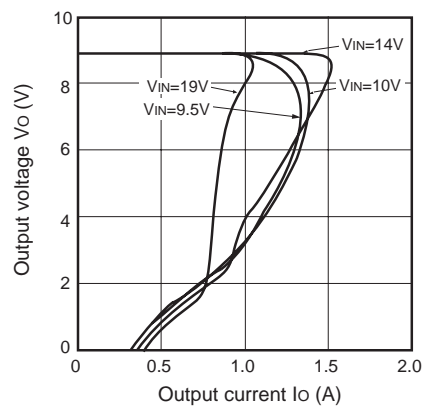

Fig.8 Overcurrent Protection Characteristics (PQ120RDA1SZH)

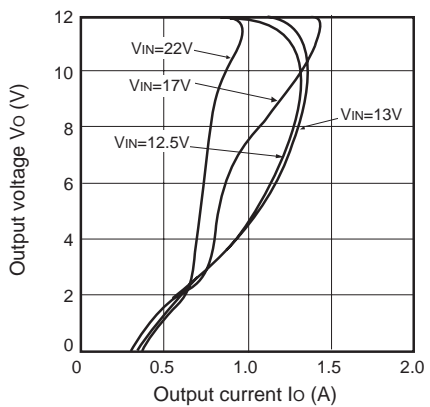

Fig.9 Output Voltage vs. Input Voltage (PQ033RDA1SZH)

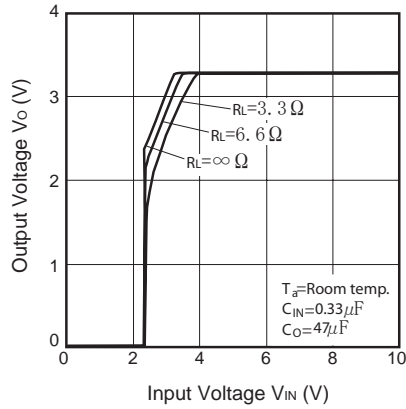

Fig.10 Output Voltage vs. Input Voltage (PQ050RDA1SZH)

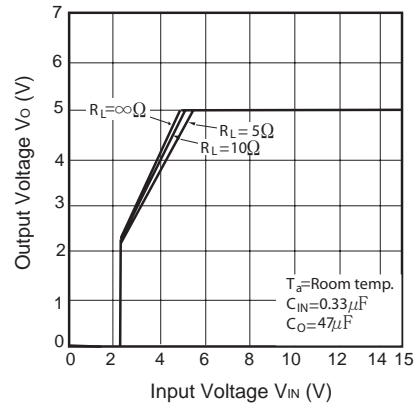

Fig.11 Output Voltage vs. Input Voltage (PQ080RDA1SZH)

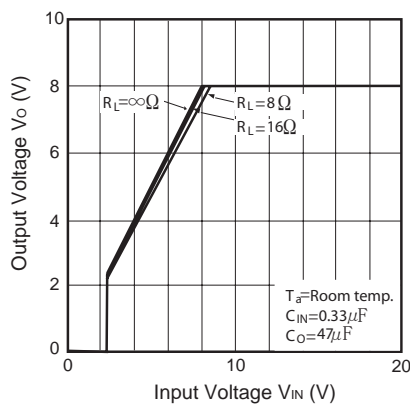

Fig.12 Output Voltage vs. Input Voltage (PQ090RDA1SZH)

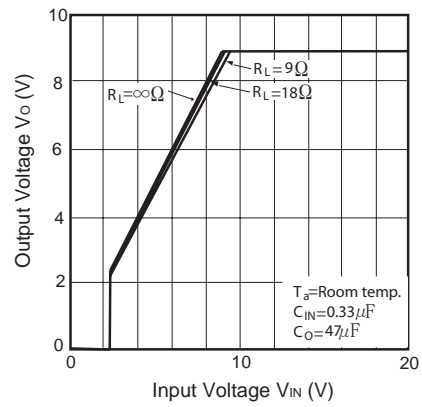

Fig.13 Output Voltage vs. Input Voltage (PQ120RDA1SZH)

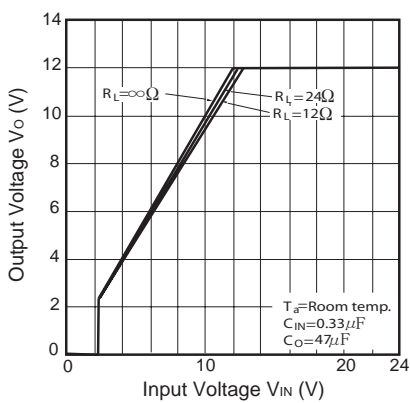

Fig.14 Circuit Operating Current vs. Input Voltage (PQ033RDA1SZH)

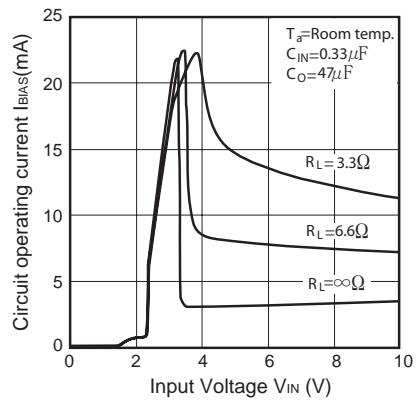

Fig.15 Circuit Operating Current vs. Input Voltage (PQ050RDA1SZH)

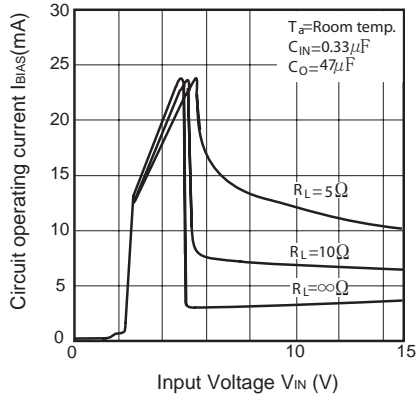

Fig.16 Circuit Operating Current vs. Input Voltage (PQ080RDA1SZH)

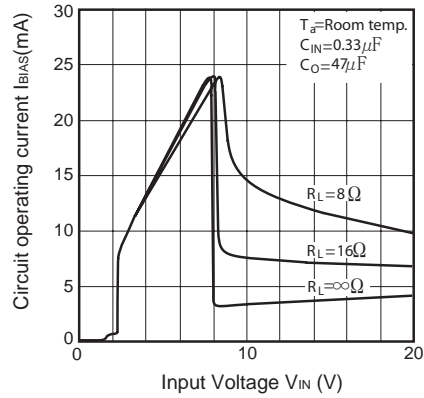

Fig.17 Circuit Operating Current vs. Input Voltage (PQ090RDA1SZH)

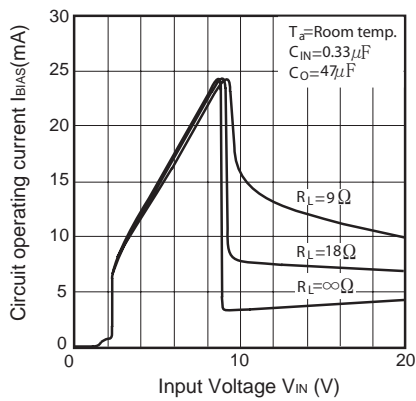

Fig.18 Circuit Operating Current vs. Input Voltage (PQ120RDA1SZH)

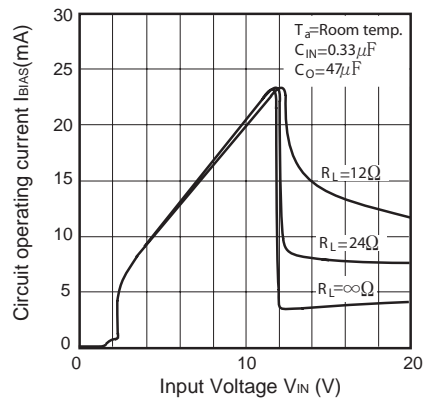

Fig.19 Dropout Voltage vs. Output Current (PQxxxRDA1SZH)

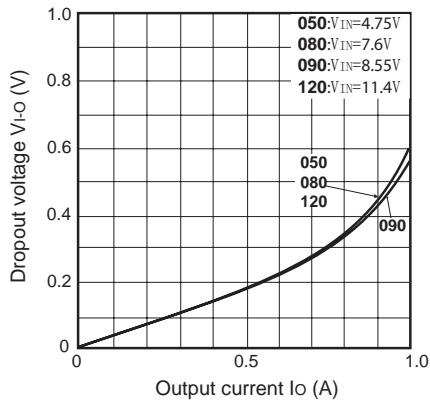

Fig.20 Output Voltage vs. Ambient Temperature (PQ033RDA1SZH)

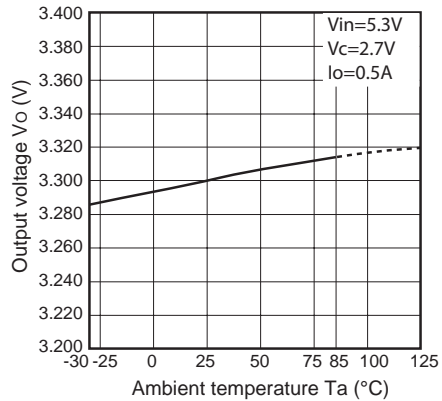

Fig.21 Output Voltage vs. Ambient Temperature (PQ050RDA1SZH)

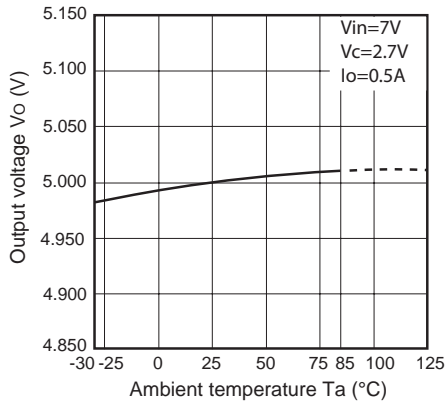

Fig.22 Output Voltage vs. Ambient Temperature (PQ080RDA1SZH)

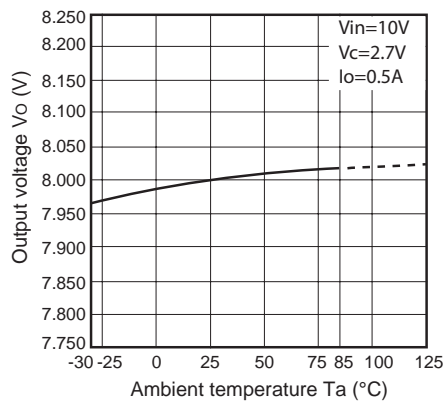

Fig.23 Output Voltage vs. Ambient Temperature (PQ090RDA1SZH)

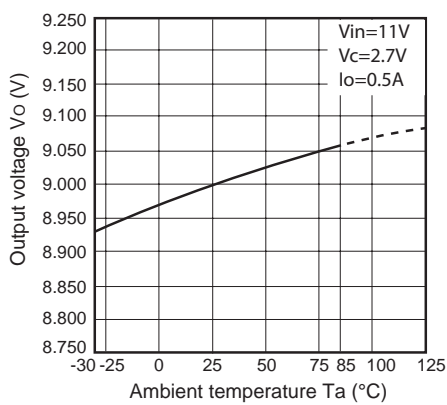

Fig.24 Output Voltage vs. Ambient Temperature (PQ120RDA1SZH)

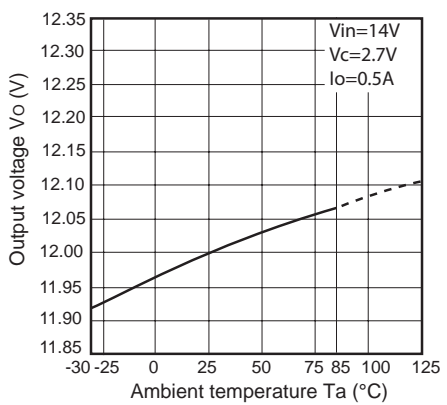

Fig.25 Dropout Voltage vs. Ambient Temperature (PQxxxRDA1SZH)

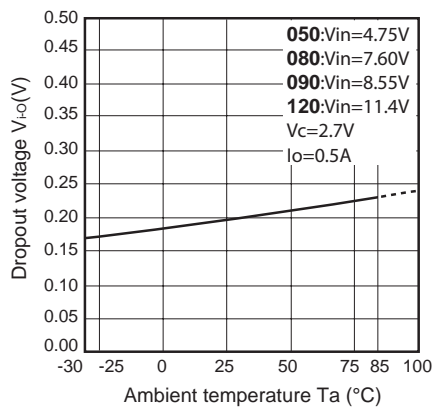

Fig.26 Quiescent Current vs. Ambient Temperature (PQxxxRDA1SZH)

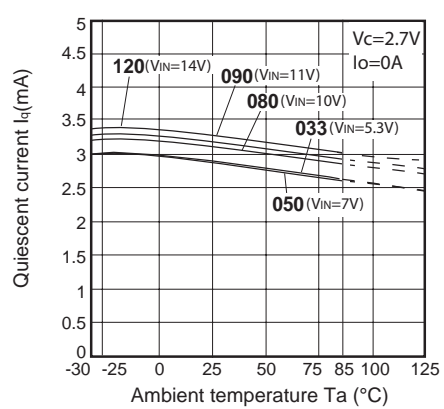
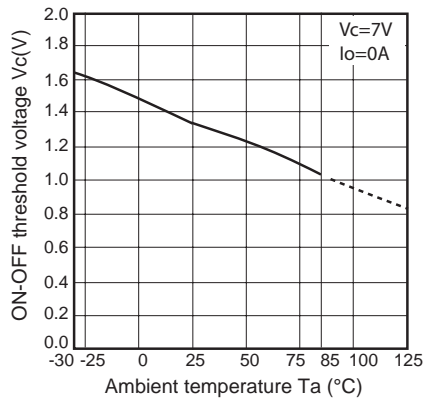

Fig.27 ON/OFF Threshold Voltage vs. Ambient Temperature (PQ050RDA1SZH)



■ Typical Application

