

ULTRA LOW DROP-LOW NOISE BICMOS VOLTAGE REGULATORS LOW ESR CAPACITORS COMPATIBLE

- INPUT VOLTAGE FROM 2.5V TO 6V
- STABLE WITH LOW ESR CERAMIC CAPACITORS
- ULTRA LOW DROPOUT VOLTAGE (100mV TYP. AT 150mA LOAD, 0.4mV TYP. AT 1mA LOAD)
- VERY LOW QUIESCENT CURRENT (85µA TYP. AT NO LOAD, 170µA TYP. AT 150mA LOAD; MAX 1.5µA IN OFF MODE)
- GUARANTEED OUTPUT CURRENT UP TO 150mA
- WIDE RANGE OF OUTPUT VOLTAGE: 1.2V; 1.22V; 1.25V; 1.35V; 1.5V; 1.8V; 2V; 2.1V; 2.2V; 2.4V; 2.5V; 2.6V; 2.7V; 2.8V; 2.85V; 2.9V; 3V; 3.1V; 3.2V; 3.3V; 4.7V; 5V
- FAST TURN-ON TIME: TYP. 200µs [$C_O=1\mu\text{F}$, $C_{BYP}=10\text{nF}$ AND $I_O=1\text{mA}$]
- LOGIC-CONTROLLED ELECTRONIC SHUTDOWN
- INTERNAL CURRENT AND THERMAL LIMIT
- OUTPUT LOW NOISE VOLTAGE 30µVRMS OVER 10Hz to 100KHz
- S.V.R. OF 60dB AT 1KHz, 50dB AT 10KHz
- TEMPERATURE RANGE: -40°C TO 125°C

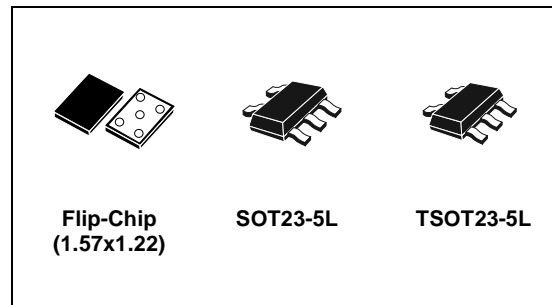

The ultra low drop-voltage, low quiescent current and low noise make it suitable for low power applications and in battery powered systems. Regulator ground current increases only slightly in dropout, further prolonging the battery life. Power supply rejection is better than 60 dB at low frequencies and starts to roll off at 10KHz. High power supply rejection is maintained down to low input voltage levels common to battery operated circuits. Shutdown Logic Control function is available, this means that when the device is used as local regulator, it is possible to put a part of the board in standby, decreasing the total power consumption. The LD3985 is designed to work with low ESR ceramic capacitors. Typical applications are in mobile phone and similar battery powered wireless systems.

DESCRIPTION

The LD3985 provides up to 150mA, from 2.5V to 6V input voltage.

Figure 1: Schematic Diagram

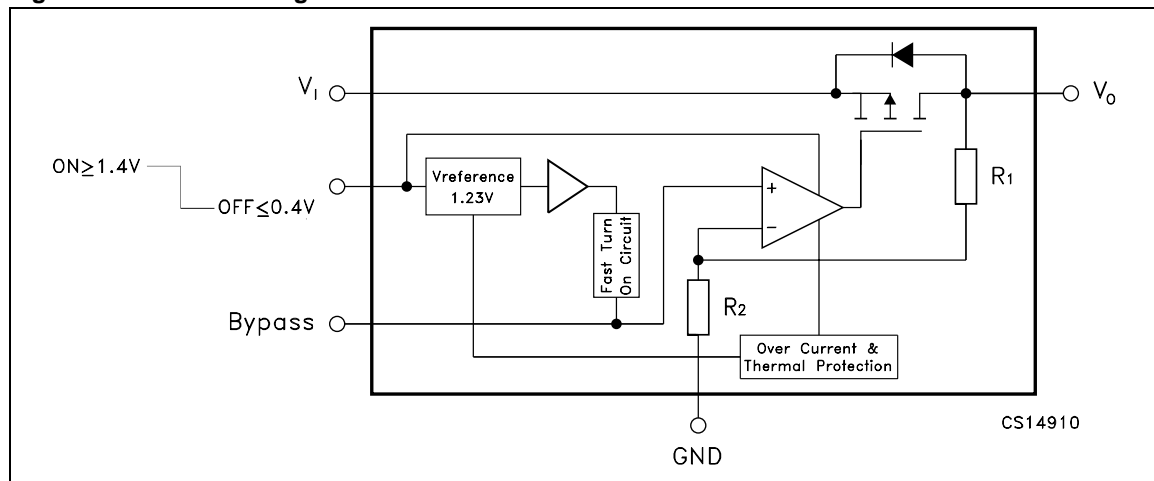

LD3985 SERIES

Table 1: Absolute Maximum Ratings

| Symbol | Parameter | Value | Unit |
|-----------|--------------------------------------|--------------------|------|
| V_I | DC Input Voltage | -0.3 to 6 (*) | V |
| V_O | DC Output Voltage | -0.3 to $V_I+0.3$ | V |
| V_{INH} | INHIBIT Input Voltage | -0.3 to $V_I+0.3$ | V |
| I_O | Output Current | Internally limited | |
| P_D | Power Dissipation | Internally limited | |
| T_{STG} | Storage Temperature Range | -65 to 150 | °C |
| T_{OP} | Operating Junction Temperature Range | -40 to 125 | °C |

Absolute Maximum Ratings are those values beyond which damage to the device may occur. Functional operation under these condition is not implied.

(*) The input pin is able to withstand non repetitive spike of 6.5V for 200ms.

Table 2: Thermal Data

| Symbol | Parameter | SOT23-5L/ TSOT23-5L | Flip-Chip | Unit |
|----------------|-------------------------------------|------------------------|-----------|------|
| $R_{thj-case}$ | Thermal Resistance Junction-case | 81 | | °C/W |
| $R_{thj-amb}$ | Thermal Resistance Junction-ambient | 255 | 170 | °C/W |

Table 3: Order Codes

| SOT23-5L | TSOT23-5L | Flip-Chip | OUTPUT VOLTAGES |
|-----------------|-----------------|-----------------|-----------------|
| LD3985M12R (*) | LD3985G12R (*) | LD3985J12R (*) | 1.20 V |
| LD3985M122R | LD3985G122R (*) | LD3985J122R | 1.22 V |
| LD3985M125R (*) | LD3985G125R (*) | LD3985J125R | 1.25 V |
| LD3985M135R (*) | LD3985G135R (*) | LD3985J135R | 1.35 V |
| LD3985M15R | LD3985G15R (*) | LD3985J15R (*) | 1.5 V |
| LD3985M18R | LD3985G18R | LD3985J18R | 1.8 V |
| LD3985M20R (*) | LD3985G20R (*) | LD3985J20R (*) | 2.0 V |
| LD3985M21R (*) | LD3985G21R (*) | LD3985J21R (*) | 2.1 V |
| LD3985M22R (*) | LD3985G22R (*) | LD3985J22R (*) | 2.2 V |
| LD3985M24R (*) | LD3985G24R (*) | LD3985J24R | 2.4 V |
| LD3985M25R | LD3985G25R | LD3985J25R | 2.5 V |
| LD3985M26R (*) | LD3985G26R (*) | LD3985J26R | 2.6 V |
| LD3985M27R | LD3985G27R | LD3985J27R | 2.7 V |
| LD3985M28R (*) | LD3985G28R (*) | LD3985J28R | 2.8 V |
| LD3985M285R (*) | LD3985G285R (*) | LD3985J285R (*) | 2.85 V |
| LD3985M29R | LD3985G29R | LD3985J29R | 2.9 V |
| LD3985M30R (*) | LD3985G30R (*) | LD3985J30R | 3.0 V |
| LD3985M31R (*) | LD3985G31R (*) | LD3985J31R | 3.1 V |
| LD3985M32R (*) | LD3985G32R (*) | LD3985J32R (*) | 3.2 V |
| LD3985M33R | LD3985G33R (*) | LD3985J33R | 3.3 V |
| LD3985M44R (*) | LD3985G44R (*) | LD3985J44R (*) | 4.4 V |
| LD3985M47R | LD3985G47R (*) | LD3985J47R | 4.7 V |
| LD3985M48R (*) | LD3985G48R (*) | LD3985J48R | 4.8 V |
| LD3985M49R (*) | LD3985G49R (*) | LD3985J49R (*) | 4.9 V |
| LD3985M50R (*) | LD3985G50R (*) | LD3985J50R (*) | 5.0 V |

(*) Available on request.

Figure 2: Connection Diagram (top view for SOT and TSOT, top through view for Flip-Chip)

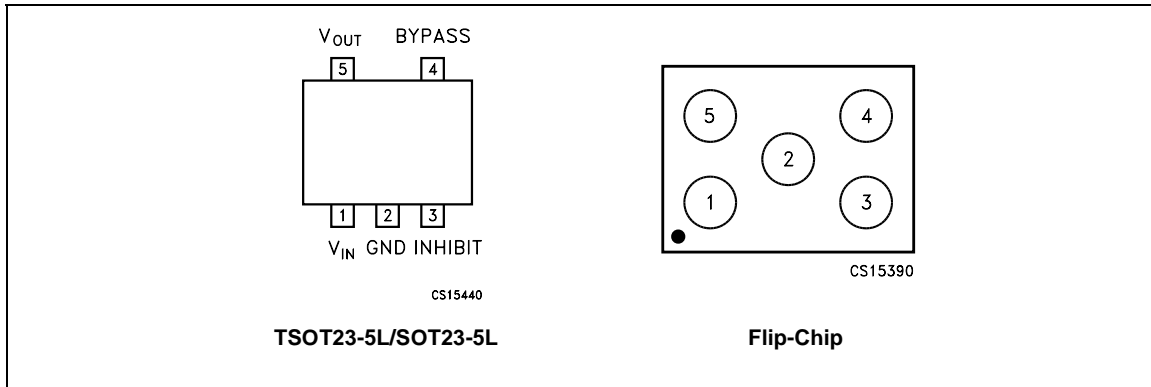
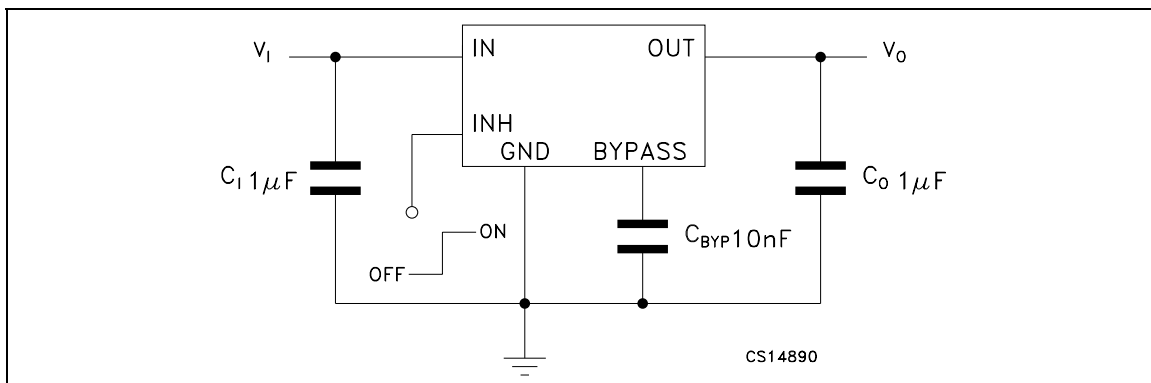

Table 4: Pin Description

| Pin N° SOT23-5L/ TSOT23-5L | Pin N° Flip-Chip | Symbol | Name and Function |
|----------------------------------|---------------------|-----------|--|
| 1 | 4 | V_I | Input Voltage of the LDO |
| 2 | 2 | GND | Common Ground |
| 3 | 1 | V_{INH} | Inhibit Input Voltage: ON MODE when $V_{INH} \geq 1.2V$, OFF MODE when $V_{INH} \leq 0.4V$ (Do not leave floating, not internally pulled down/up) |
| 4 | 5 | BYPASS | Bypass Pin: Connect an external capacitor (usually 10nF) to minimize noise voltage |
| 5 | 3 | V_O | Output Voltage of the LDO |

Figure 3: Typical Application Circuit



LD3985 SERIES

Table 5: Electrical Characteristics For LD3985 ($T_J = 25^\circ\text{C}$, $V_I = V_{O(NOM)} + 0.5\text{V}$, $C_I = 1\mu\text{F}$, $C_{BYP} = 10\text{nF}$, $I_O = 1\text{mA}$, $V_{INH} = 1.4\text{V}$, unless otherwise specified)

| Symbol | Parameter | Test Conditions | Min. | Typ. | Max. | Unit |
|--------------|---|--|--------------------|---------|-------|---------------------|
| V_I | Operating Input Voltage | | 2.5 | | 6 | V |
| V_O | Output Voltage < 2.5V | $I_O = 1\text{mA}$ | -50 | | 50 | mV |
| | | $T_J = -40\text{ to }125^\circ\text{C}$ | -75 | | 75 | |
| V_O | Output Voltage $\geq 2.5\text{V}$ | $I_O = 1\text{mA}$ | -2 | | 2 | % of $V_{O(NOM)}$ |
| | | $T_J = -40\text{ to }125^\circ\text{C}$ | -3 | | 3 | |
| ΔV_O | Line Regulation (Note 1) | $V_I = V_{O(NOM)} + 0.5\text{ to }6\text{V}$, $T_J = -40\text{ to }125^\circ\text{C}$ | -0.1 | | 0.1 | %/V |
| | | $V_O = 4.7\text{ to }5\text{V}$ | -0.19 | | 0.19 | |
| ΔV_O | Load Regulation | $I_O = 1\text{mA to }150\text{mA}$ $V_O < 2.5\text{V}$ $T_J = -40\text{ to }125^\circ\text{C}$ | | 0.002 | 0.008 | %/mA |
| ΔV_O | Load Regulation | $I_O = 1\text{mA to }150\text{mA}$ $V_O \geq 2.5\text{V}$ $T_J = -40\text{ to }125^\circ\text{C}$ (for Flip-Chip) | | 0.0004 | 0.002 | %/mA |
| | | $I_O = 1\text{mA to }150\text{mA}$, $T_J = -40\text{ to }125^\circ\text{C}$ (for SOT23-5L/TSOT23-5L), $V_O \geq 2.5\text{V}$ | | 0.0025 | 0.005 | |
| ΔV_O | Output AC Line Regulation | $V_I = V_{O(NOM)} + 1\text{V}$, $I_O = 150\text{mA}$, $t_R = t_F = 30\mu\text{s}$ | | 1.5 | | mV _{PP} |
| I_Q | Quiescent Current ON MODE: $V_{INH} = 1.2\text{V}$ | $I_O = 0$ | | 85 | | μA |
| | | $I_O = 0$ $T_J = -40\text{ to }125^\circ\text{C}$ | | | 150 | |
| | | $I_O = 0\text{ to }150\text{mA}$ | | 170 | | |
| | | $I_O = 0\text{ to }150\text{mA}$ $T_J = -40\text{ to }125^\circ\text{C}$ | | | 250 | |
| | OFF MODE: $V_{INH} = 0.4\text{V}$ | | | 0.003 | | |
| | | $T_J = -40\text{ to }125^\circ\text{C}$ | | | 1.5 | |
| V_{DROP} | Dropout Voltage (NOTE 1) | $I_O = 1\text{mA}$ | | 0.4 | | mV |
| | | $I_O = 1\text{mA}$ $T_J = -40\text{ to }125^\circ\text{C}$ | | | 2 | |
| | | $I_O = 50\text{mA}$ | | 20 | | |
| | | $I_O = 50\text{mA}$ $T_J = -40\text{ to }125^\circ\text{C}$ | | | 35 | |
| | | $I_O = 100\text{mA}$ | | 45 | | |
| | | $I_O = 100\text{mA}$ $T_J = -40\text{ to }125^\circ\text{C}$ | | | 70 | |
| | | $I_O = 150\text{mA}$ | | 60 | | |
| | | $I_O = 150\text{mA}$ $T_J = -40\text{ to }125^\circ\text{C}$ | | | 100 | |
| I_{SC} | Short Circuit Current | $R_L = 0$ | | 600 | | mA |
| SVR | Supply Voltage Rejection | $V_I = V_{O(NOM)} + 0.25\text{V} \pm$ $V_{RIPPLE} = 0.1\text{V}$, $I_O = 50\text{mA}$ $V_{O(NOM)} < 2.5\text{V}$, $V_I = 2.55\text{V}$ | $f = 1\text{KHz}$ | 60 | | dB |
| | | | $f = 10\text{KHz}$ | 50 | | |
| $I_{O(PK)}$ | Peak Output Current | $V_O \geq V_{O(NOM)} - 5\%$ | 300 | 550 | | mA |
| V_{INH} | Inhibit Input Logic Low | $V_I = 2.5\text{V to }6\text{V}$ $T_J = -40\text{ to }125^\circ\text{C}$ | | | 0.4 | V |
| | Inhibit Input Logic High | | 1.2 | | | |
| I_{INH} | Inhibit Input Current | $V_{INH} = 0.4\text{V}$ $V_I = 6\text{V}$ | | ± 1 | | nA |
| eN | Output Noise Voltage | $B_W = 10\text{ Hz to }100\text{ KHz}$ $C_O = 1\mu\text{F}$ | | 30 | | μV_{RMS} |
| t_{ON} | Turn On Time (Note 4) | $C_{BYP} = 10\text{ nF}$ | | 100 | 250 | μs |
| T_{SHDN} | Thermal Shutdown | Note 5 | | 160 | | $^\circ\text{C}$ |

| Symbol | Parameter | Test Conditions | Min. | Typ. | Max. | Unit |
|----------------|------------------|----------------------|------|------|------|------|
| C _O | Output Capacitor | Capacitance (Note 6) | 1 | | 22 | μF |
| | | ESR | 5 | | 5000 | mΩ |

Note 1 – For V_{O(NOM)} < 2V, V_I = 2.5V

Note 2 – For V_{O(NOM)} = 1.25V, V_I = 2.5V

Note 3 – Dropout voltage is the input-to-output voltage difference at which the output voltage is 100mV below its nominal value. This specification does not apply for input voltages below 2.5V.

Note 4 – Turn-on time is time measured between the enable input just exceeding V_{INH} High Value and the output voltage just reaching 95% of its nominal value

Note 5 – Typical thermal protection hysteresis is 20°C

Note 6 - The minimum capacitor value is 1μF, anyway the LD3985 is still stable if the compensation capacitor has a 30% tolerance in all temperature range.

TYPICAL PERFORMANCE CHARACTERISTICS (T_j = 25°C, V_I = V_{O(NOM)} + 0.5V, C_I = C_O = 1μF, C_{BYP} = 10nF, I_O = 1mA, V_{INH} = 1.4V, unless otherwise specified)

Figure 4: Output Voltage vs Temperature

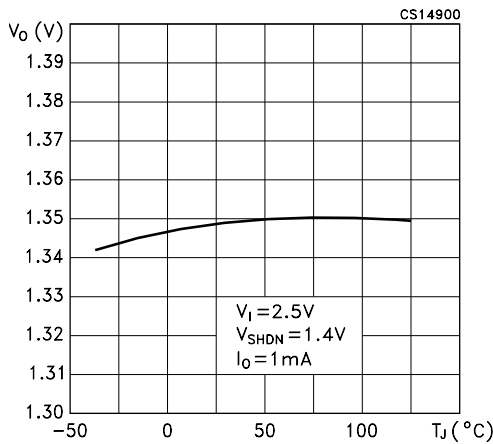

Figure 5: Output Voltage vs Temperature

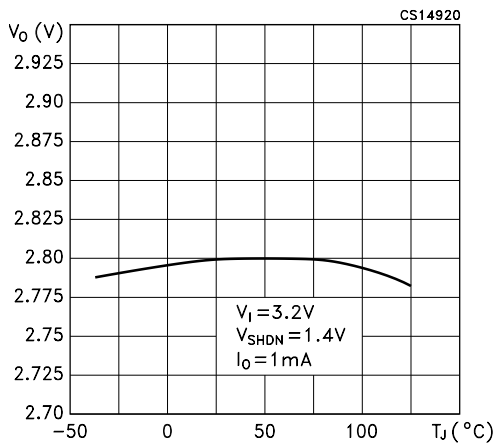

Figure 6: Output Voltage vs Temperature

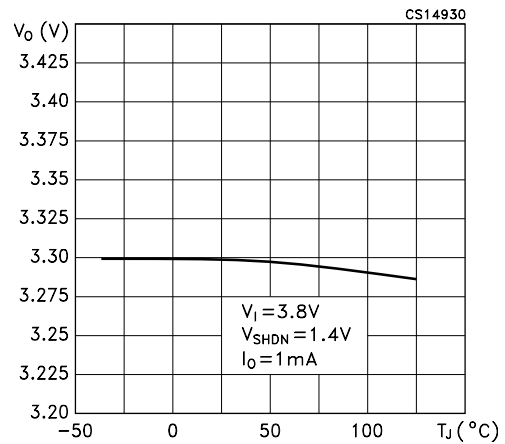

Figure 7: Shutdown Voltage vs Temperature

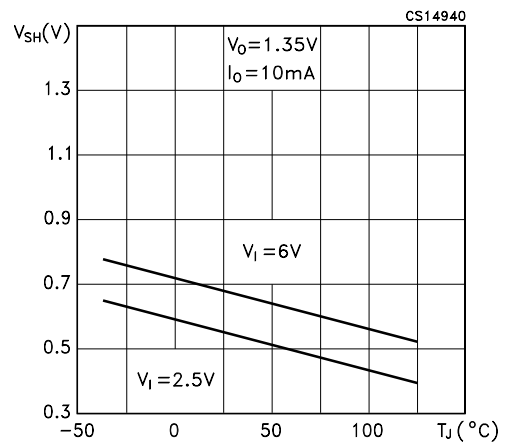

Figure 8: Shutdown Voltage vs Temperature

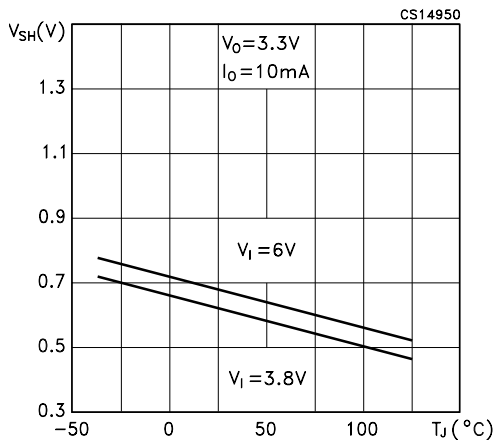

Figure 9: Line Regulation vs Temperature

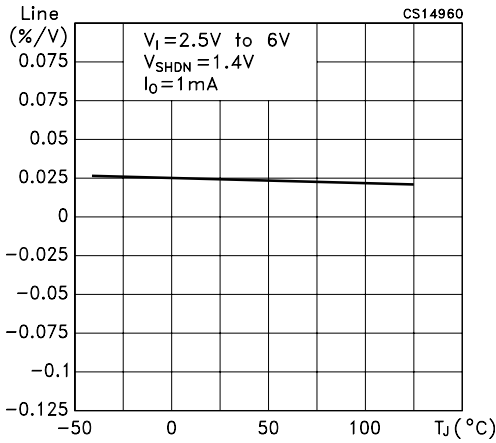

Figure 10: Line Regulation vs Temperature

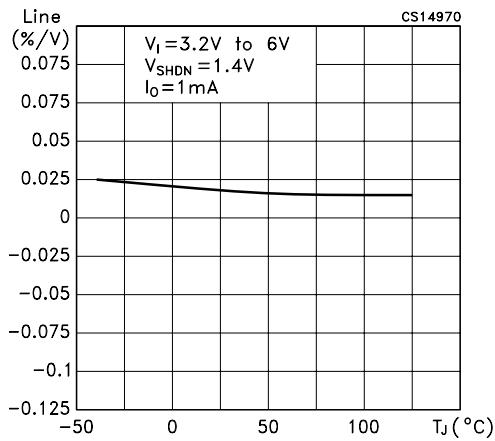

Figure 11: Line Regulation vs Temperature

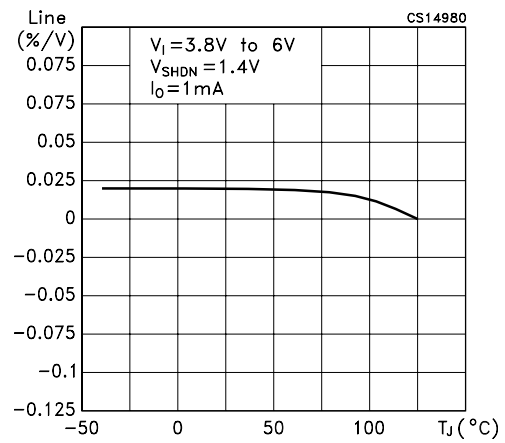

Figure 12: Load Regulation vs Temperature

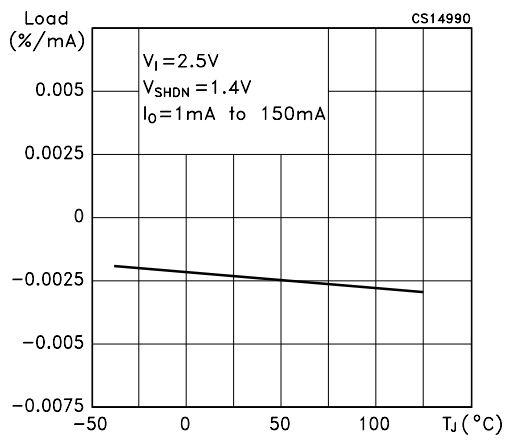

Figure 13: Load Regulation vs Temperature

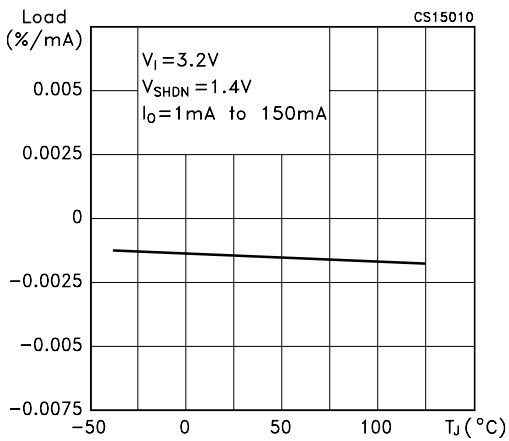

Figure 14: Load Regulation vs Temperature

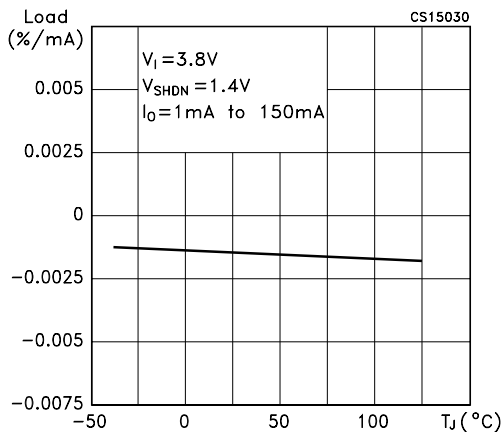

Figure 17: Quiescent Current vs Temperature

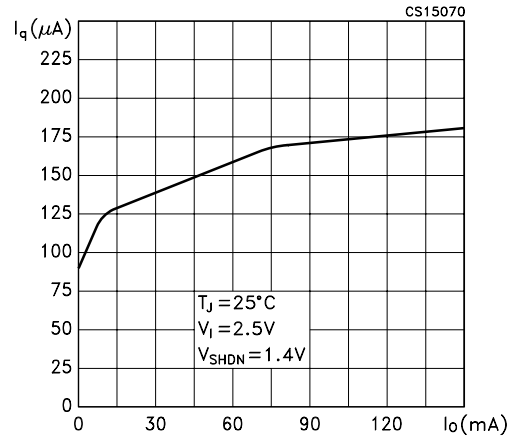

Figure 15: Quiescent Current vs Temperature

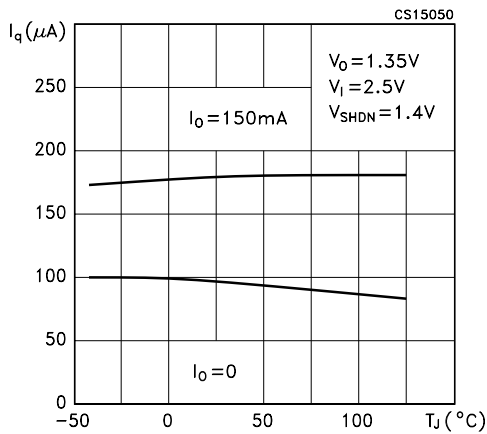

Figure 18: Supply Voltage Rejection vs Frequency

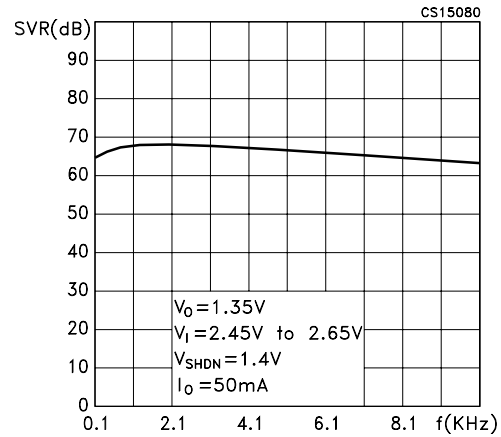

Figure 16: Quiescent Current vs Temperature

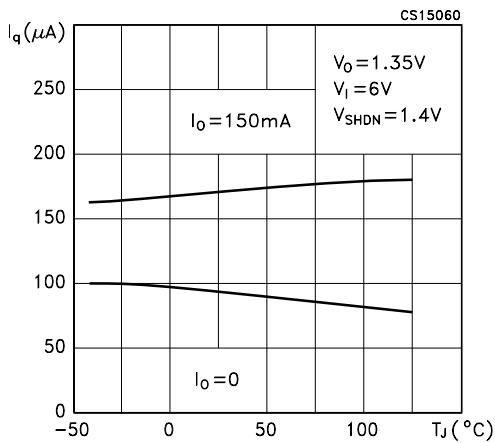
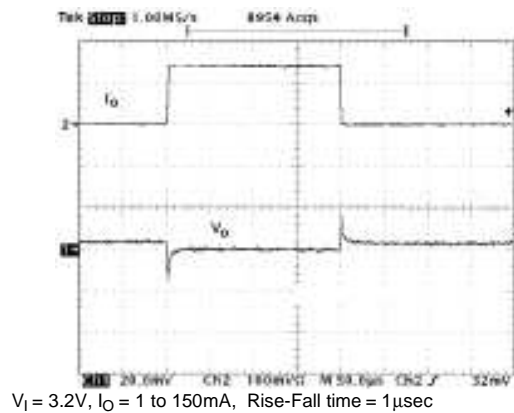
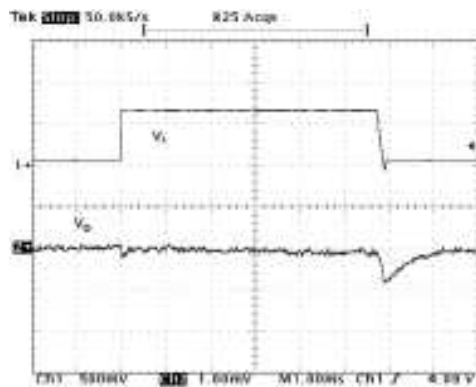

Figure 19: Load Transient Response



LD3985 SERIES

Figure 20: Line Transient Response



$V_I = 3.8\text{V to } 4.4\text{V}$, $T_J = 25^\circ\text{C}$, $I_O = 150\text{mA}$, $C_I = C_O = 1\mu\text{F (X7R)}$, $C_{BYP} = 10\text{nF}$, Rise-Fall time = $1\mu\text{sec}$, $V_O = 2.7\text{V}$

Figure 22: TURN-OFF

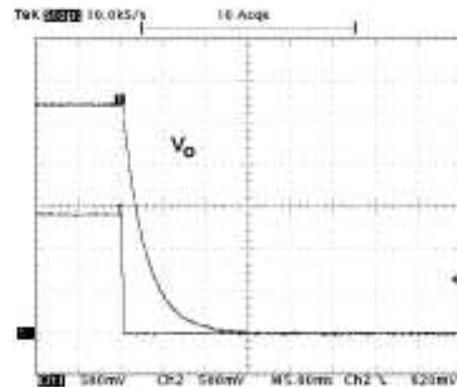

$V_I = 3.3\text{V}$, $I_O = 1\text{mA}$, $C_I = C_O = 1\mu\text{F (cer)}$, $C_{BYP} = 10\text{nF}$, $T_r = 20\text{ns}$, $V_O = 2.8\text{V}$

Figure 21: START-UP

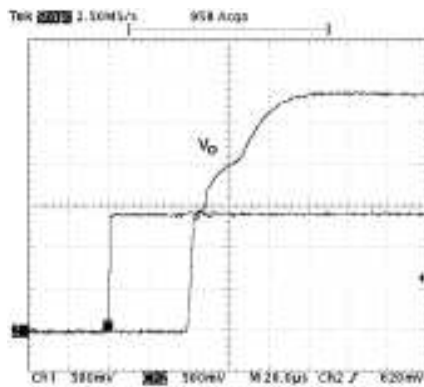

$V_I = 3.3\text{V}$, $I_O = 1\text{mA}$, $C_I = C_O = 1\mu\text{F (cer)}$, $C_{BYP} = 10\text{nF}$, $T_r = 20\text{ns}$, $V_O = 2.8\text{V}$

SOT23-5L MECHANICAL DATA

| DIM. | mm. | | | mils | | |
|------|------|------|------|-------|------|-------|
| | MIN. | TYP | MAX. | MIN. | TYP. | MAX. |
| A | 0.90 | | 1.45 | 35.4 | | 57.1 |
| A1 | 0.00 | | 0.10 | 0.0 | | 3.9 |
| A2 | 0.90 | | 1.30 | 35.4 | | 51.2 |
| b | 0.35 | | 0.50 | 13.7 | | 19.7 |
| C | 0.09 | | 0.20 | 3.5 | | 7.8 |
| D | 2.80 | | 3.00 | 110.2 | | 118.1 |
| E | 1.50 | | 1.75 | 59.0 | | 68.8 |
| e | | 0.95 | | | 37.4 | |
| H | 2.60 | | 3.00 | 102.3 | | 118.1 |
| L | 0.10 | | 0.60 | 3.9 | | 23.6 |

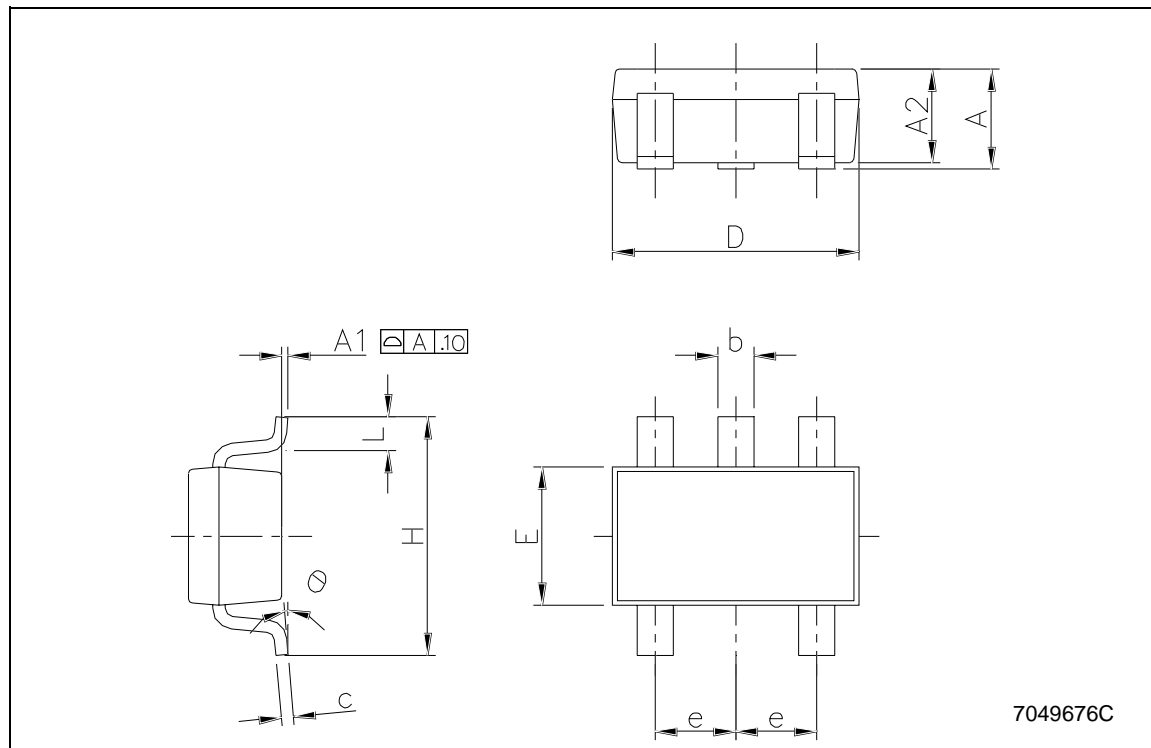

TSOT23-5L MECHANICAL DATA

| DIM. | mm. | | | mils | | |
|------|------|------|------|------|-------|------|
| | MIN. | TYP | MAX. | MIN. | TYP. | MAX. |
| A | | | 1.1 | | | 43.3 |
| A1 | 0 | | 0.1 | | | 3.9 |
| A2 | 0.7 | | 1.0 | 27.6 | | 39.4 |
| b | 0.3 | | 0.5 | 11.8 | | 19.7 |
| C | 0.08 | | 0.2 | 3.1 | | 7.9 |
| D | | 2.9 | | | 114.2 | |
| E | | 2.8 | | | 110.2 | |
| E1 | | 1.6 | | | 63.0 | |
| e | | 0.95 | | | 37.4 | |
| e1 | | 1.9 | | | 74.8 | |
| L | 0.3 | | 0.6 | 11.8 | | 23.6 |

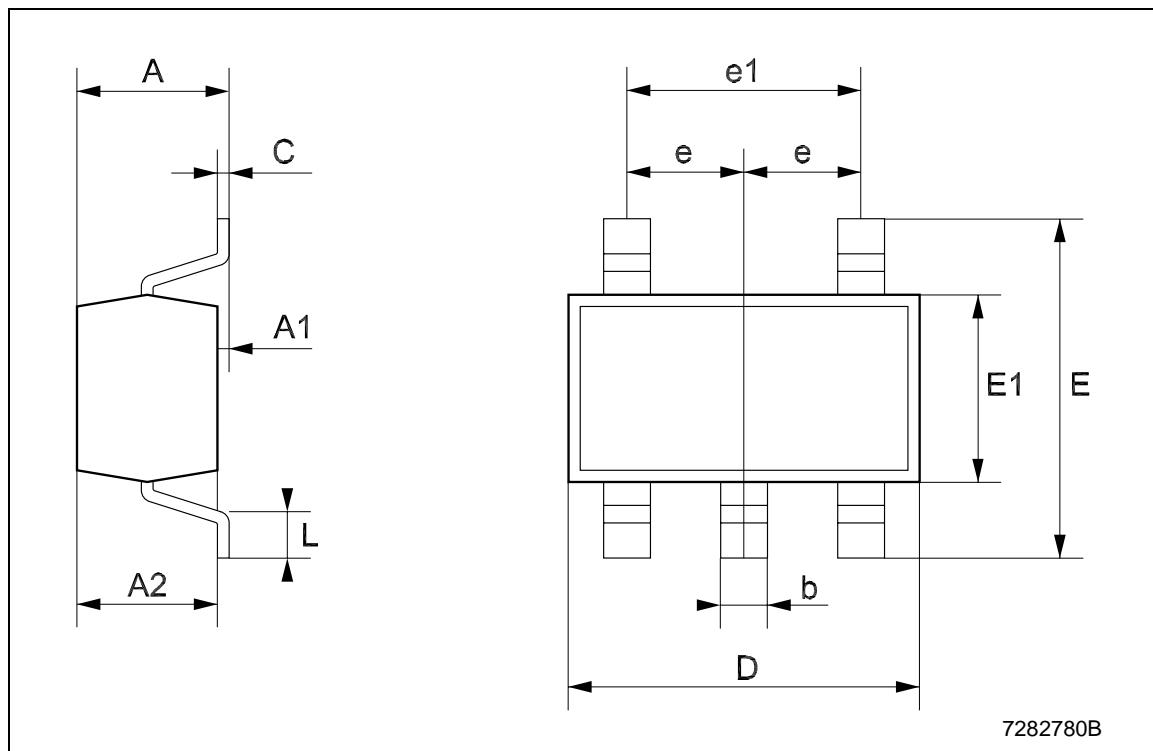

Flip-Chip5 MECHANICAL DATA

| DIM. | mm. | | | mils | | |
|------|-------|-------|-------|--------|--------|--------|
| | MIN. | TYP | MAX. | MIN. | TYP. | MAX. |
| A | 0.835 | 0.9 | 0.965 | 32.874 | 35.433 | 37.992 |
| A1 | 0.21 | 0.25 | 0.29 | 8.268 | 9.843 | 11.417 |
| A2 | 0.625 | 0.65 | 0.675 | 24.606 | 25.591 | 26.575 |
| b | 0.265 | 0.315 | 0.365 | 10.433 | 12.402 | 14.370 |
| D | 1.510 | 1.540 | 1.570 | 59.449 | 60.630 | 61.811 |
| E | 1.16 | 1.19 | 1.22 | 45.669 | 46.850 | 48.031 |
| e | 0.45 | 0.5 | 0.55 | 17.717 | 19.685 | 21.654 |
| e1 | 0.816 | 0.866 | 0.916 | 32.126 | 34.094 | 36.063 |
| f | | 0.345 | | | 13.583 | |
| f1 | | 0.337 | | | 13.268 | |

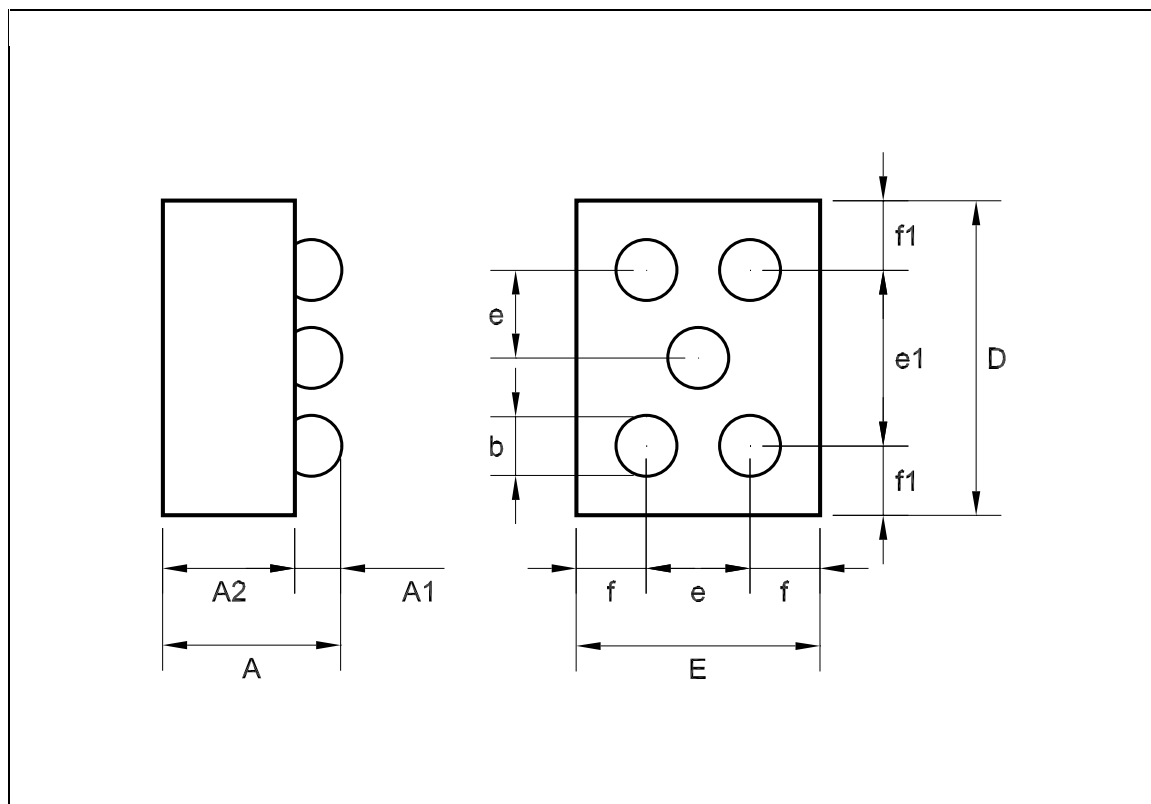

Tape & Reel SOT23-xL MECHANICAL DATA

| DIM. | mm. | | | inch | | |
|------|------|------|------|-------|-------|-------|
| | MIN. | TYP | MAX. | MIN. | TYP. | MAX. |
| A | | | 180 | | | 7.086 |
| C | 12.8 | 13.0 | 13.2 | 0.504 | 0.512 | 0.519 |
| D | 20.2 | | | 0.795 | | |
| N | 60 | | | 2.362 | | |
| T | | | 14.4 | | | 0.567 |
| Ao | 3.13 | 3.23 | 3.33 | 0.123 | 0.127 | 0.131 |
| Bo | 3.07 | 3.17 | 3.27 | 0.120 | 0.124 | 0.128 |
| Ko | 1.27 | 1.37 | 1.47 | 0.050 | 0.054 | 0.058 |
| Po | 3.9 | 4.0 | 4.1 | 0.153 | 0.157 | 0.161 |
| P | 3.9 | 4.0 | 4.1 | 0.153 | 0.157 | 0.161 |

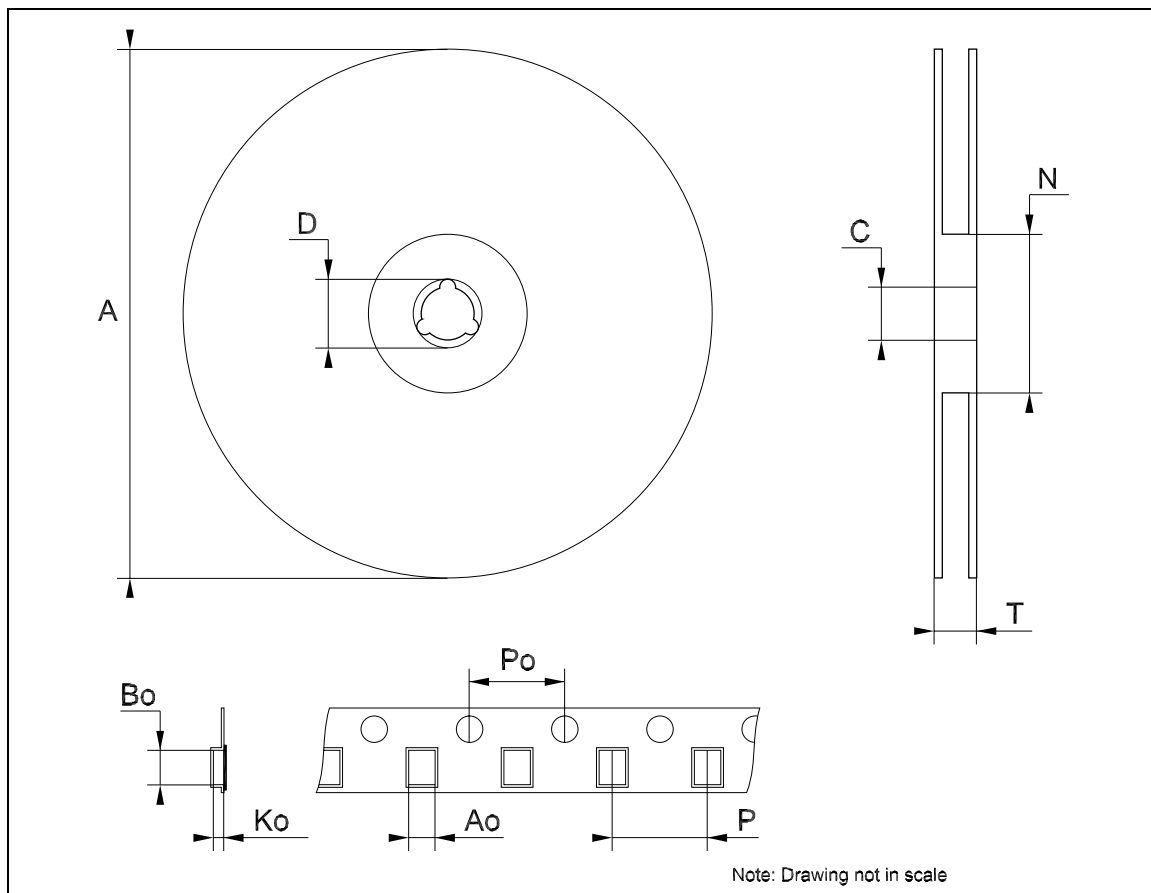

Table 6: Revision History

| Date | Revision | Description of Changes |
|-------------|----------|--|
| 07-May-2004 | 6 | Part Number Status Changed on Table 3. |
| 05-Oct-2004 | 7 | t _{ON} values are Changed on Table 5. |
| 27-Oct-2004 | 8 | Order Codes changed - Table 3. |

Information furnished is believed to be accurate and reliable. However, STMicroelectronics assumes no responsibility for the consequences of use of such information nor for any infringement of patents or other rights of third parties which may result from its use. No license is granted by implication or otherwise under any patent or patent rights of STMicroelectronics. Specifications mentioned in this publication are subject to change without notice. This publication supersedes and replaces all information previously supplied. STMicroelectronics products are not authorized for use as critical components in life support devices or systems without express written approval of STMicroelectronics.

The ST logo is a registered trademark of STMicroelectronics
All other names are the property of their respective owners

© 2004 STMicroelectronics - All Rights Reserved

STMicroelectronics group of companies

Australia - Belgium - Brazil - Canada - China - Czech Republic - Finland - France - Germany - Hong Kong - India - Israel - Italy - Japan -
Malaysia - Malta - Morocco - Singapore - Spain - Sweden - Switzerland - United Kingdom - United States of America

www.st.com