

## Single Supply, Rail-to-Rail Output Dual Operational Amplifier

### ■ GENERAL DESCRIPTION

The NJM8202 is a low noise Rail-to-Rail output dual operational amplifier. It is tolerant to RF noise.

Rail-to-Rail output function provides wide dynamic range, is from ground to power supply level. And input range is from ground level.

It is suitable for audio section of portable sets, PCs and any General-purpose applications.

### ■ PACKAGE OUTLINE



NJM8202M



NJM8202E



NJM8202V



NJM8202R



NJM8202RB1

### ■ FEATURES

- RF Immunity Enhance the RF immunity from mobile phones
- Rail-to-Rail Output 0.25V~4.75V min. @V+=5V
- Operating Temperature -40°C ~+85°C
- Operation Voltage +2.5V~+14V(±1.25~±7V)
- Slew Rate 3.5V/μs(typ.)
- GBW 10MHz(typ.)
- Voltage noise 10n/√Hz(typ.) @1kHz
- Input Offset Voltage 6.0mV(max.)
- Supply Current 5mA(max.)
- Package DMP8, EMP8, SSOP8 VSP8, TVSP8

### ■ APPLICATIONS

- Note PC, PDA
- Mobile phone
- Audio signal processing
- Current detect
- Buffer, Active filter

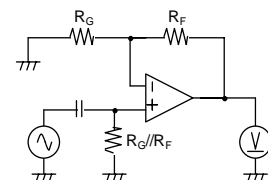
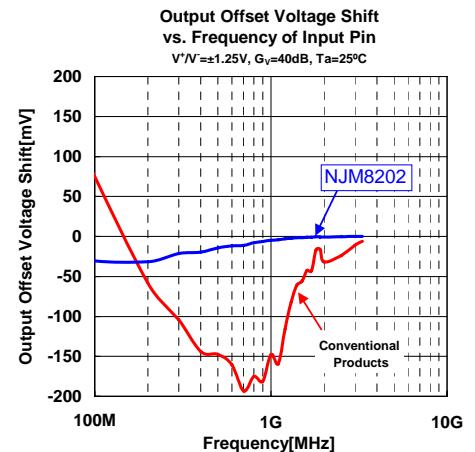

Test Circuit

### ■ TYPICAL APPLICATION

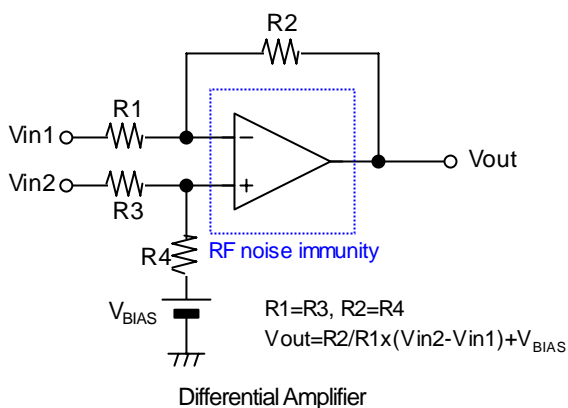

### ■ PIN CONFIGURATION

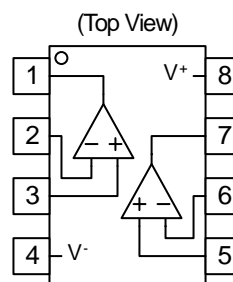

#### Pin Function

1. A OUTPUT
2. A -INPUT
3. A +INPUT
4. V<sup>-</sup>
5. B +INPUT
6. B -INPUT
7. B OUTPUT
8. V<sup>+</sup>

# NJM8202

## ■ ABSOLUTE MAXIMUM RATINGS (Ta=25°C)

PARAMETER	SYMBOL	RATING	UNIT
Supply Voltage	V <sup>+</sup>	15	V
Common Mode Input Voltage Range	V <sub>ICM</sub>	0~15 (Note1)	V
Differential Input Voltage Range	V <sub>ID</sub>	±15 (Note1)	V
Power Dissipation (Note3)	P <sub>D</sub>	380 [DMP8], 530 [DMP8](Note2) 300 [EMP8], 690 [EMP8] (Note2) 250 [SSOP8], 460 [SSOP8] (Note2) 320 [VSP8], 595 [VSP8] (Note2) 320 [TVSP8], 580 [TVSP8] (Note2)	mW
Operating Temperature Range	Topr	-40~+85	°C
Storage Temperature Range	Tstg	-50~+150	°C

(Note1) For supply voltage less than 15V, the absolute maximum input voltage is equal to supply voltage.

(Note2) On the PCB "EIA/JEDEC (114.3x76.2x1.6mm, 2 layers, FR-4)"

(Note3) See Figure1 "Power Dissipation Derating Curve" when ambient temperature is over 25°C.

**Figure1**  
Power Dissipation Derating Curve

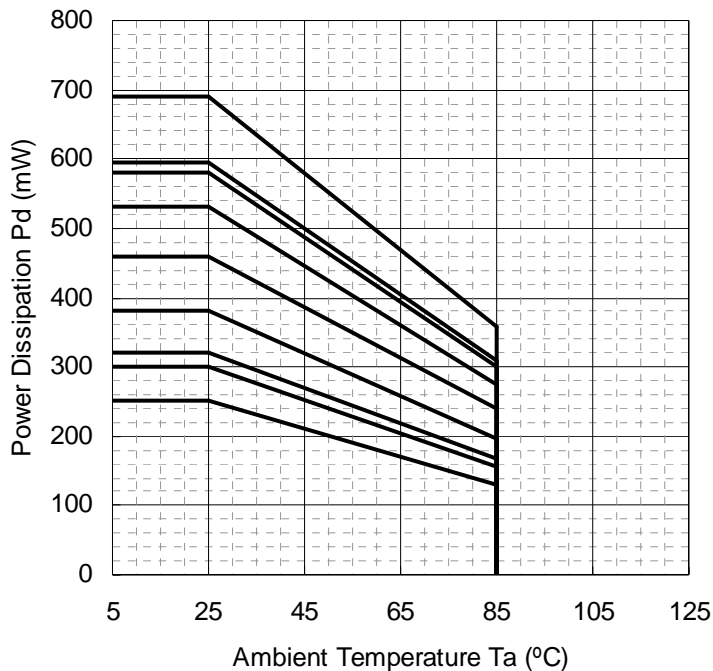

Pkg.	δPd (mW/°C)	Pd (25°C)	Pd (85°C)
DMP8	-3.04	380	198
EMP8	-2.40	300	156
SSOP8	-2.00	250	130
TVSP8	-2.56	320	166
VSP8	-2.56	320	166
DMP8(2 Layer)	-4.24	530	276
EMP8(2 Layer)	-5.52	690	359
SSOP8(2 Layer)	-3.68	460	239
TVSP8(2 Layer)	-4.64	580	302
VSP8(2 Layer)	-4.76	595	309

## ■ RECOMMENDED OPERATING VOLTAGE (Ta=-40~+85°C)

PARAMETER	SYMBOL	TEST CONDITION	MIN.	TYP.	MAX.	UNIT
Supply Voltage	V <sup>+</sup>		2.5	-	14	V

■ ELECTRICAL CHARACTERISTICS

● ELECTRICAL CHARACTERISTICS (  $V^+=5V$ ,  $T_a=25^\circ C$  )

PARAMETER	SYMBOL	TEST CONDITION	MIN.	TYP.	MAX.	UNIT
Supply Current	$I_{CC}$	$R_L=\infty$ , $V_{IN}=2.5V$ , No Signal	-	4	5	mA
Input Offset Voltage	$V_{IO}$		-	1	6	mV
Input Bias Current	$I_B$		-	100	350	nA
Input Offset Current	$I_{IO}$		-	5	100	nA
Voltage Gain	$A_v$	$R_L \geq 10k\Omega$ to 2.5V, $V_o=0.5V\sim 4.5V$	65	85	-	dB
Common Mode Rejection Ratio	CMR	$0V \leq V_{CM} \leq 4V$	60	75	-	dB
Supply Voltage Rejection Ratio	SVR	$V^+=2.5V$ to 14V	60	80	-	dB
Maximum Output Voltage1	$V_{OH1}$	$R_L \geq 5k\Omega$ to 2.5V	4.75	4.9	-	V
	$V_{OL1}$	$R_L \geq 5k\Omega$ to 2.5V	-	0.1	0.25	V
Maximum Output Voltage2	$V_{OH2}$	$R_L \geq 5k\Omega$ to GND	4.75	4.9	-	V
	$V_{OL2}$	$R_L \geq 5k\Omega$ to GND	-	-	0.25	V
Common Mode Input Voltage Range	$V_{ICM}$	CMR $\geq 60$ dB	0	-	4	V
Gain Bandwidth Product	GB	$f=1$ MHz	-	10	-	MHz
Phase Margin	$\Phi_M$	$R_L=10k\Omega$ , $C_L=10$ pF	-	50	-	deg
Equivalent Input Noise Voltage	$V_{NI}$	$f=1$ kHz, $V_{CM}=2.5V$	-	10	-	nV/ $\sqrt{Hz}$
Total Harmonic Distortion	THD	$f=1$ kHz, $A_v=+2$ , $R_L=10k\Omega$ to 2.5V, $V_o=1.5V_{rms}$	-	0.001	-	%
Channel Separation	CS	$f=1$ kHz, $R_L=10k\Omega$ to 2.5V, $V_o=1.5V_{rms}$	-	120	-	dB
Slew Rate	SR	(Note4), $A_v=1$ , $V_{IN}=2V_{pp}$ $R_L=10k\Omega$ to 2.5V, $C_L=10$ pF to 2.5V	-	3.5	-	V/ $\mu s$

## ■ TYPICAL CHARACTERISTICS

Supply Current vs. Supply Voltage  
(Temperature)  
 $G_v=0dB$

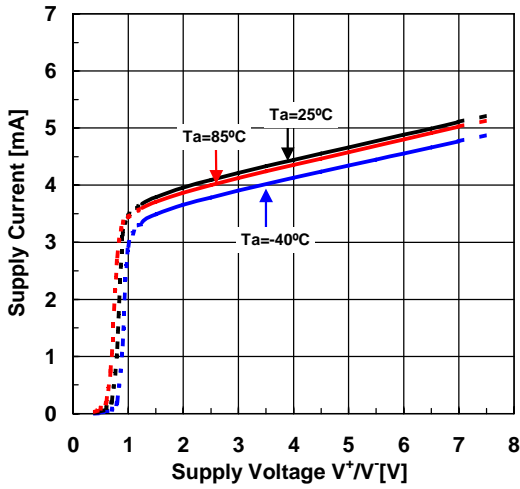

Supply Current vs. Temperature  
(Supply Voltage)  
 $G_v=0dB$

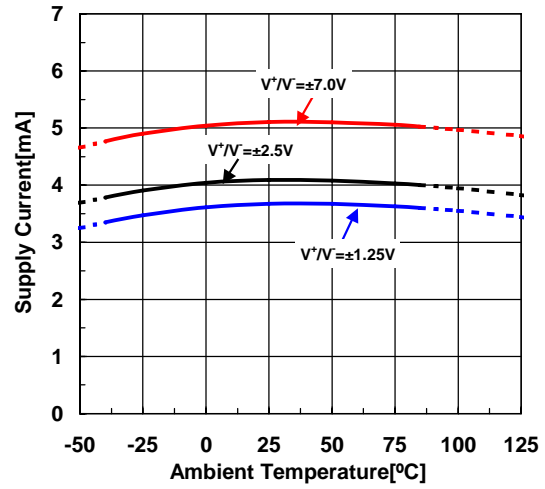

Input Offset Voltage vs. Temperature (Supply Voltage)  
 $V_{CM}=0V$

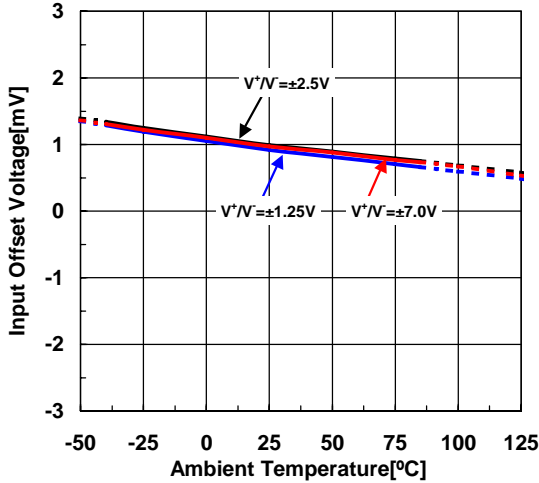

Input Offset Voltage vs. Supply Voltage (Temperature)  
 $V_{CM}=0V$

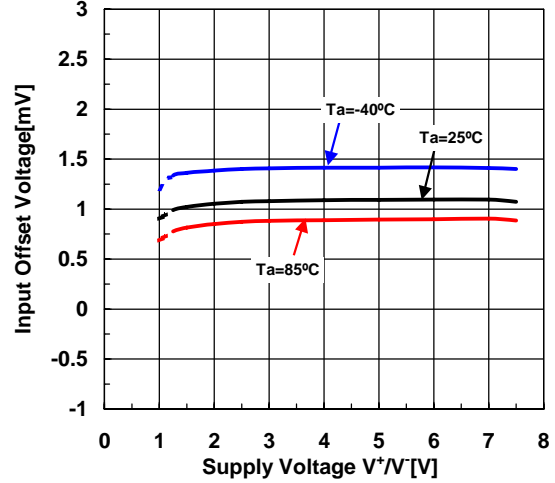

Input Offset Voltage vs. Common Mode Input Voltage  
(Temperature)  
 $V^+V^-=\pm 1.25V$

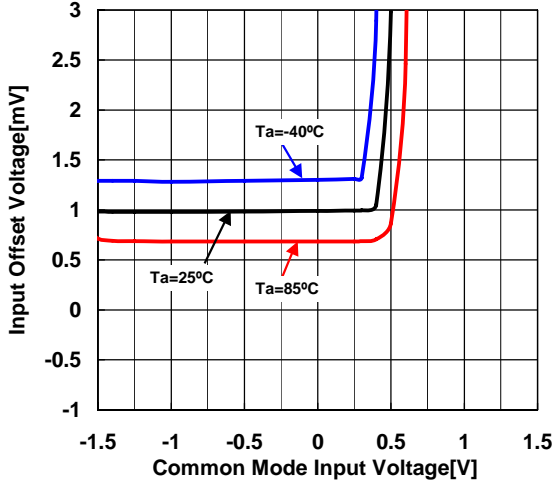

Input Offset Voltage vs. Common Mode Input Voltage  
(Temperature)  
 $V^+V^-=\pm 2.5V$

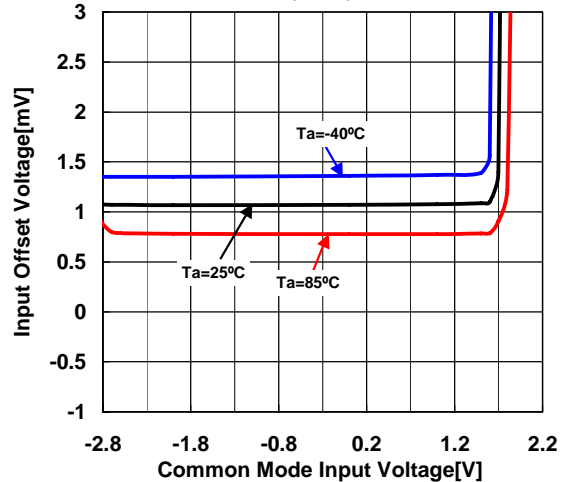

## ■ TYPICAL CHARACTERISTICS

**Input Offset Voltage  
vs. Common Mode Input Voltage  
(Temperature)**  
 $V^+V^- = \pm 7.0V$

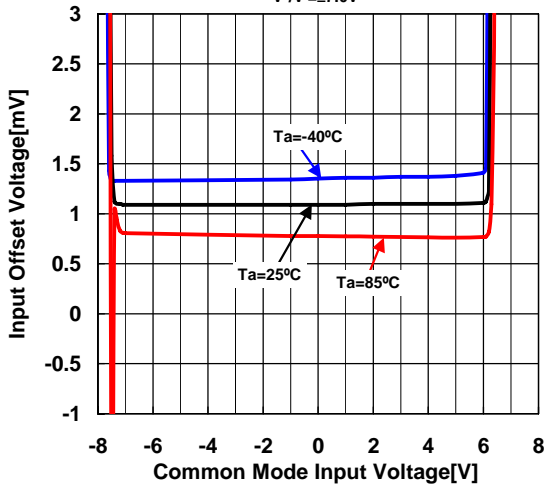

**Input Offset Current vs. Temperature**  
 $V^+V^- = \pm 2.5V$

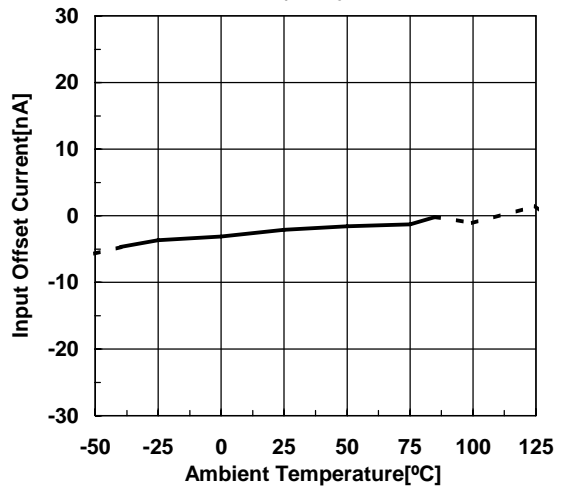

**Input Bias Current vs. Temperature**  
 $V^+V^- = \pm 2.5V$

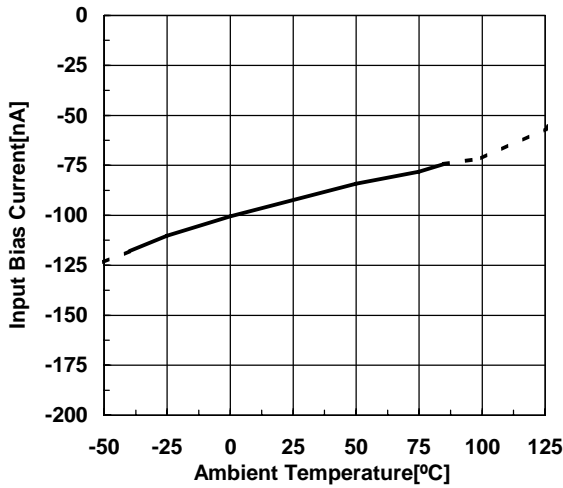

**Voltage Gain vs. Temperature**  
 $V^+V^- = \pm 2.5V, R_L = 10k\Omega$

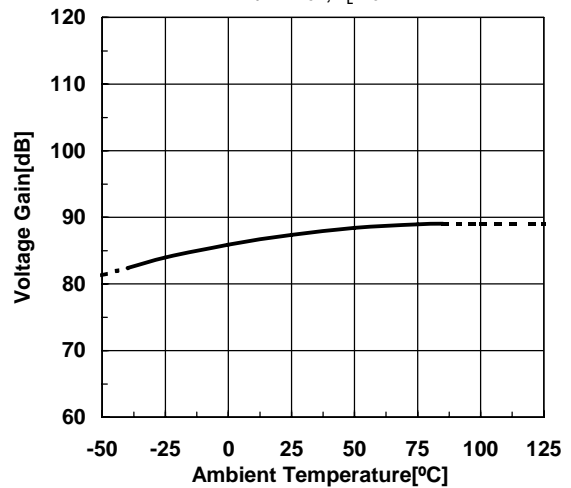

**Common Mode Rejection Ratio vs. Temperature**  
 $V^+V^- = \pm 2.5V$

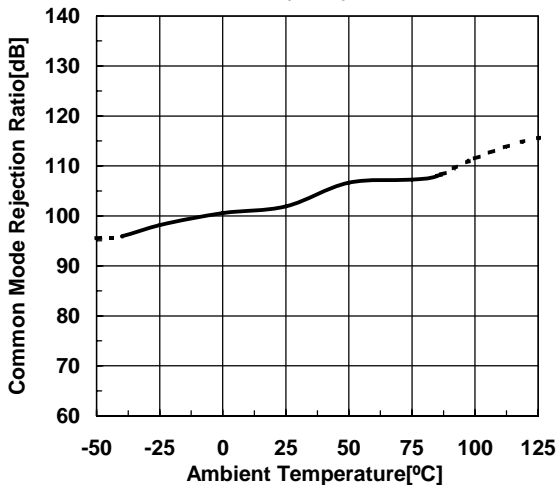

**Supply Voltage Rejection Ratio vs. Temperature**  
 $V^+V^- = \pm 2.5V$

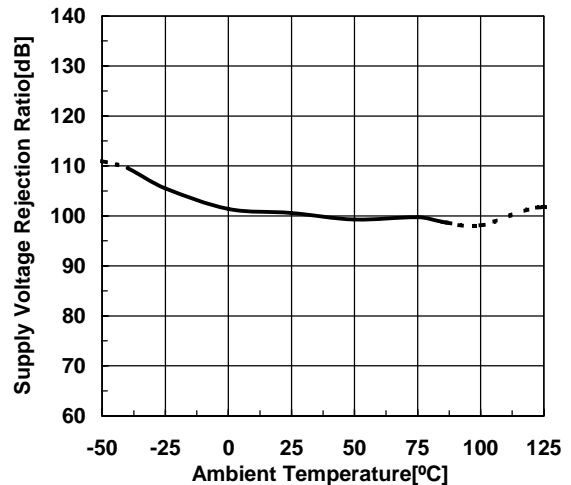

## ■ TYPICAL CHARACTERISTICS

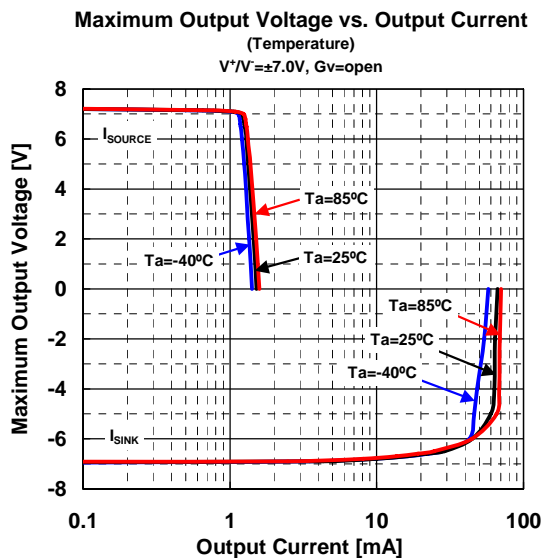
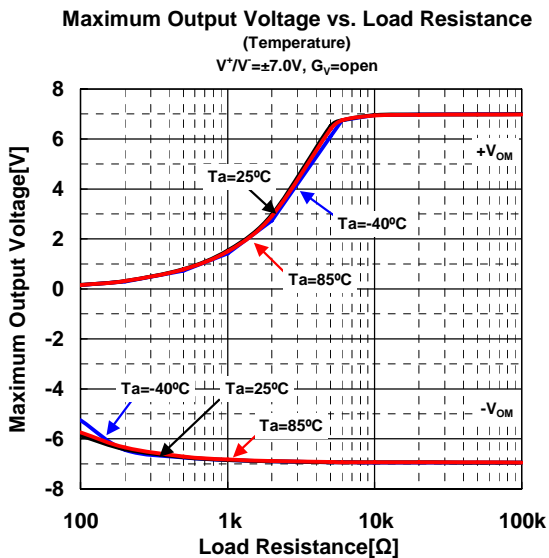
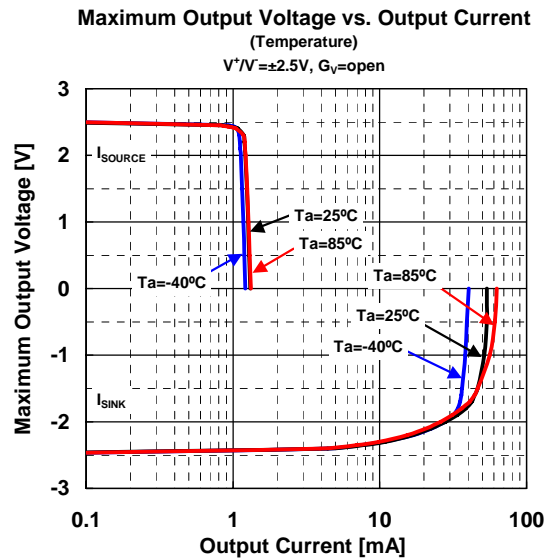
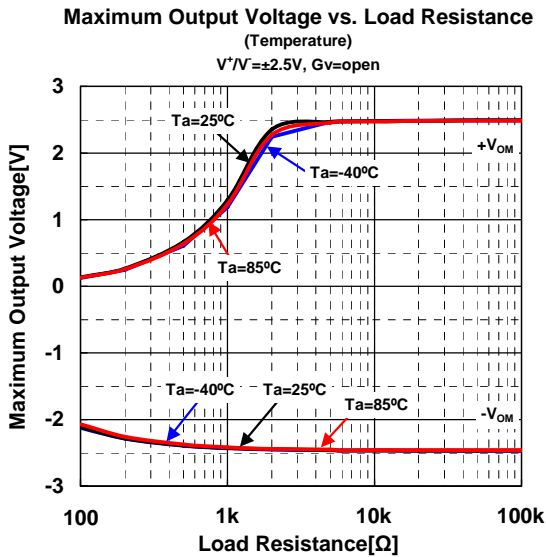
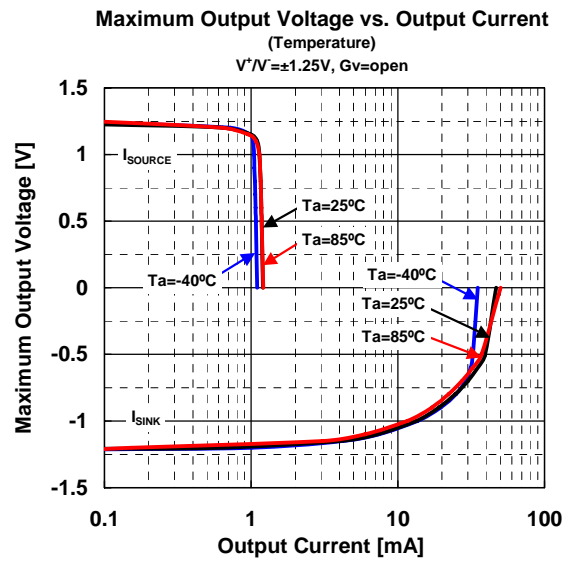
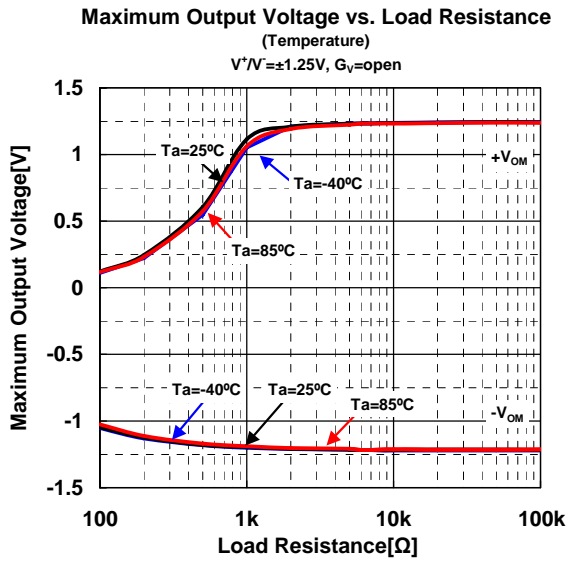

## ■ TYPICAL CHARACTERISTICS

**Maximum Output Voltage vs. Supply Voltage**  
(Temperature)  
G<sub>v</sub>=open, R<sub>L</sub>=5kΩ

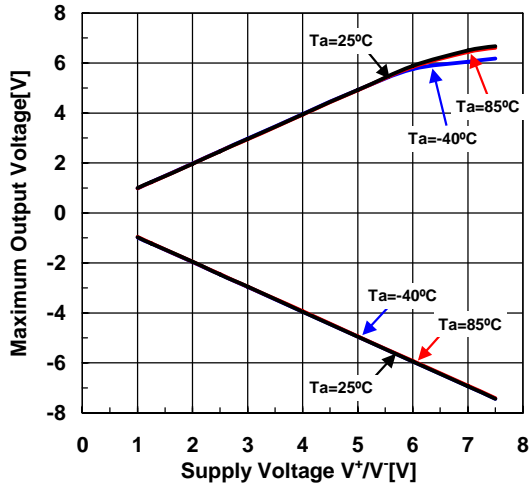

**Maximum Output Voltage vs. Supply Voltage**  
(Temperature)  
G<sub>v</sub>=open, R<sub>L</sub>=10kΩ

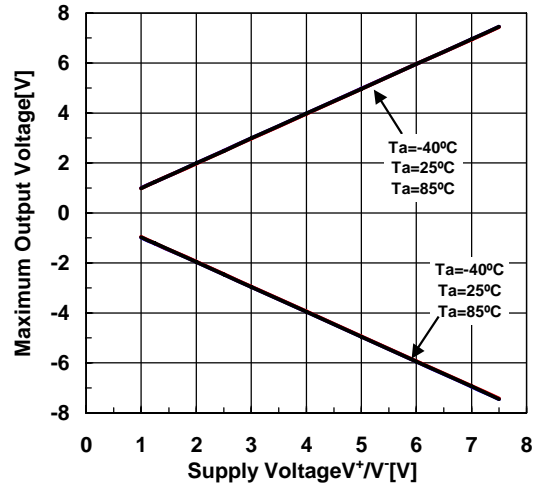

**40dB Gain/Phase vs. Frequency (Temperature)**  
V<sub>+/V-</sub>=±1.25V, V<sub>IN</sub>=-30dBm, G<sub>v</sub>=40dB, R<sub>F</sub>=10kΩ, C<sub>L</sub>=10pF

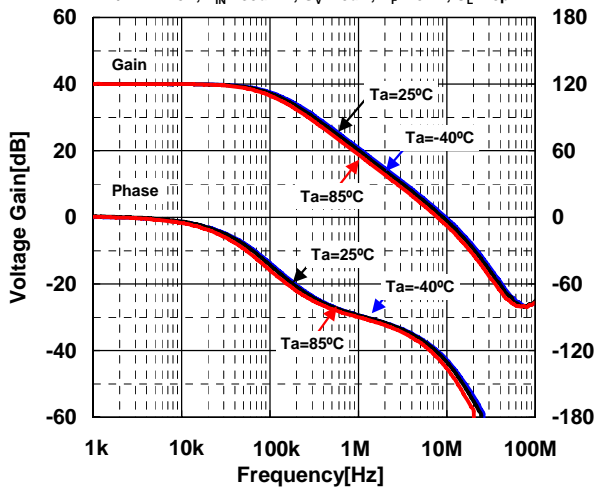

**40dB Gain/Phase vs. Frequency (Load Capacitance)**  
V<sub>+/V-</sub>=±1.25V, V<sub>IN</sub>=-30dBm, G<sub>v</sub>=40dB, R<sub>F</sub>=10kΩ, Ta=25°C

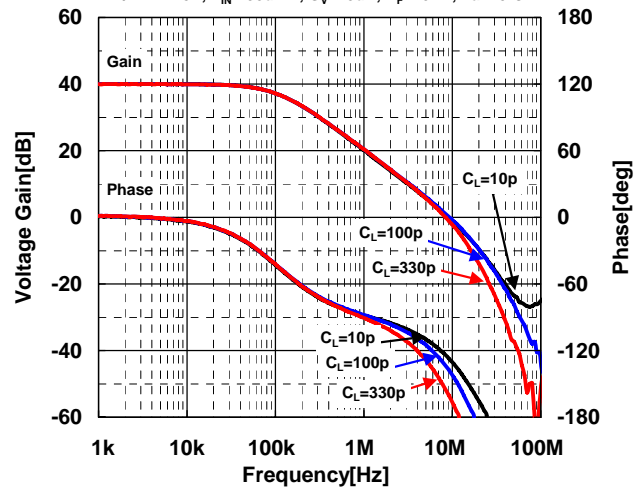

**40dB Gain/Phase vs. Frequency (Temperature)**  
V<sub>+/V-</sub>=±2.5V, V<sub>IN</sub>=-30dBm, G<sub>v</sub>=40dB, R<sub>F</sub>=10kΩ, C<sub>L</sub>=10pF

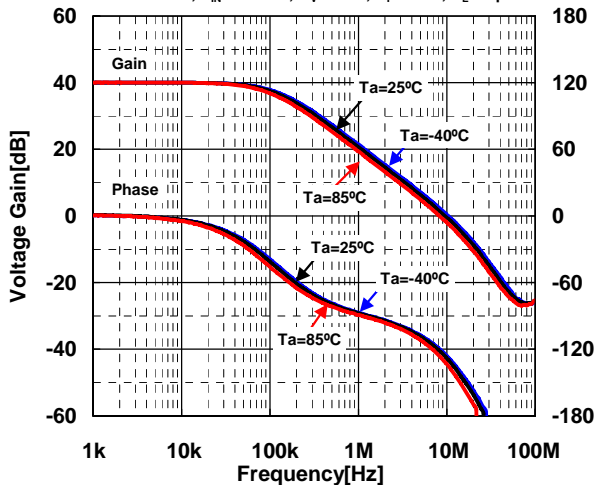

**40dB Gain/Phase vs. Frequency (Load Capacitance)**  
V<sub>+/V-</sub>=±2.5V, V<sub>IN</sub>=-30dBm, G<sub>v</sub>=40dB, R<sub>F</sub>=10kΩ, Ta=25°C

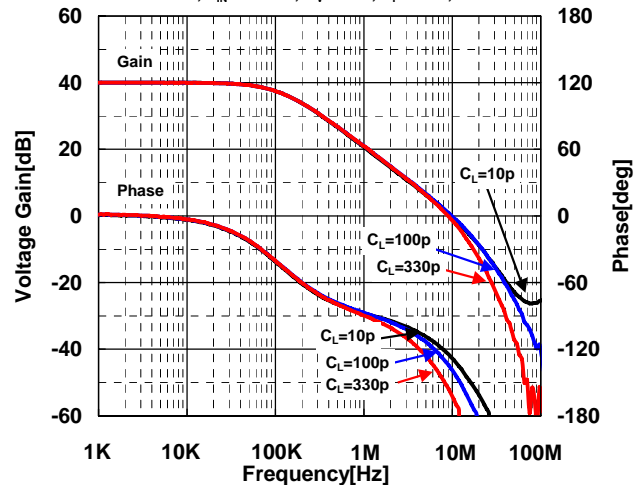

## ■ TYPICAL CHARACTERISTICS

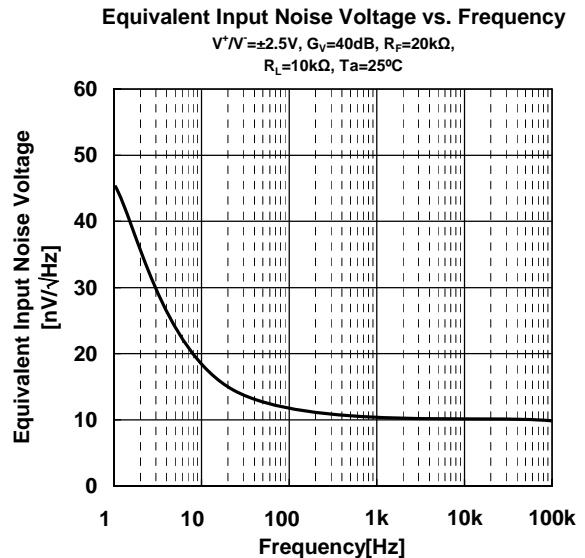
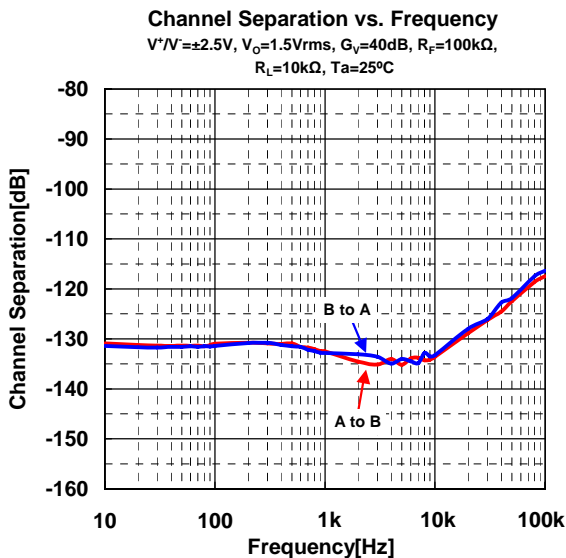
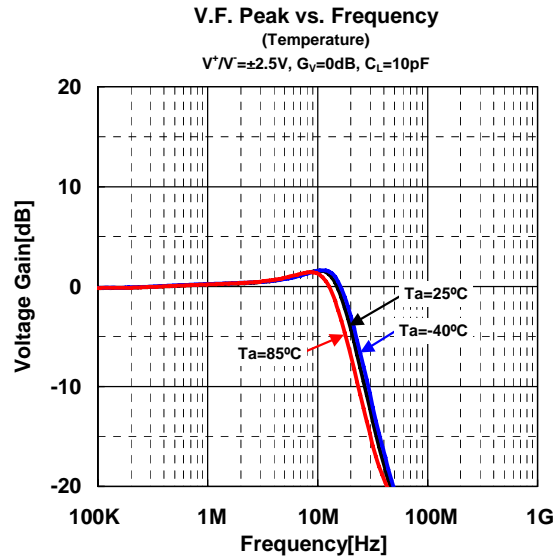
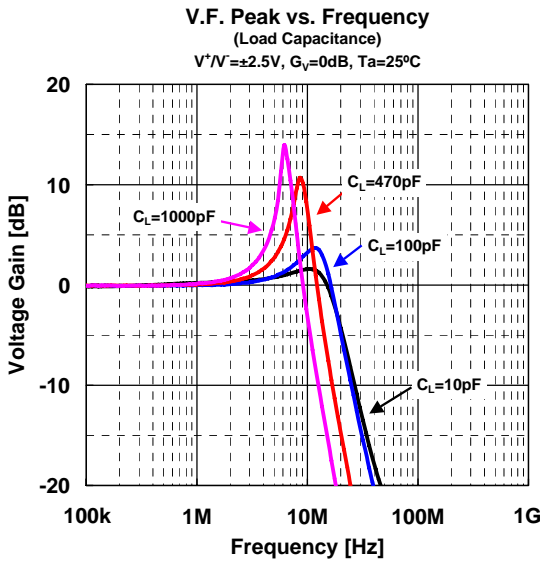
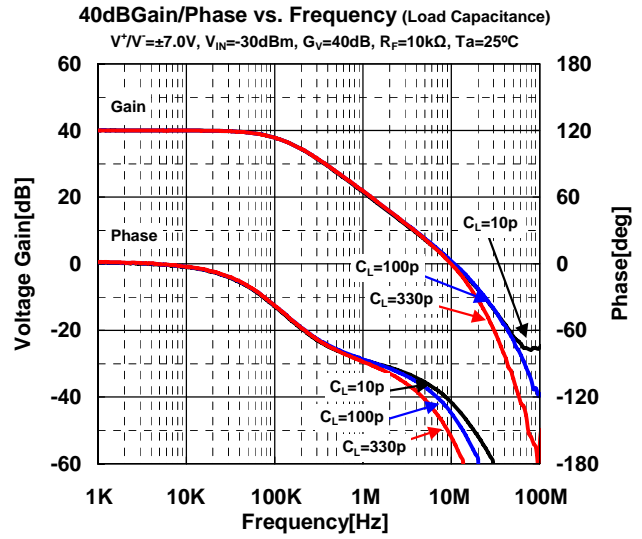
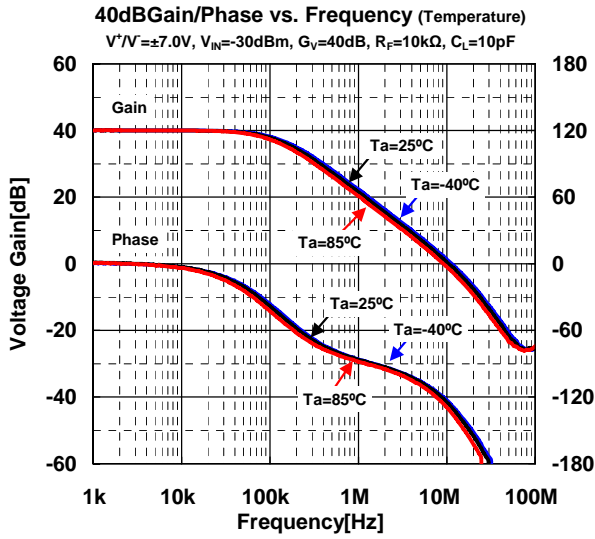



## ■ TYPICAL CHARACTERISTICS

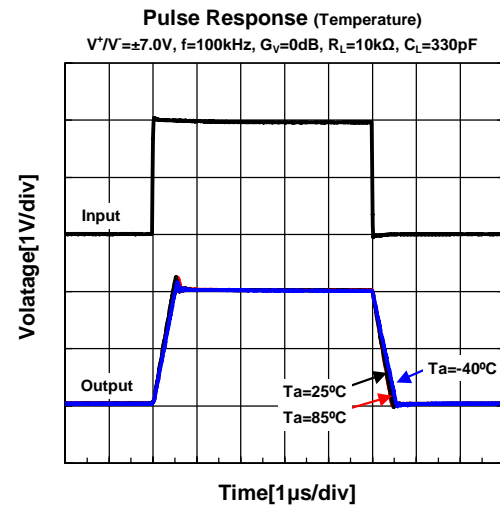
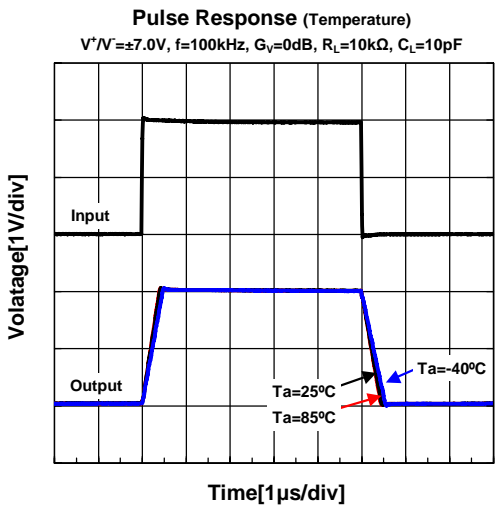
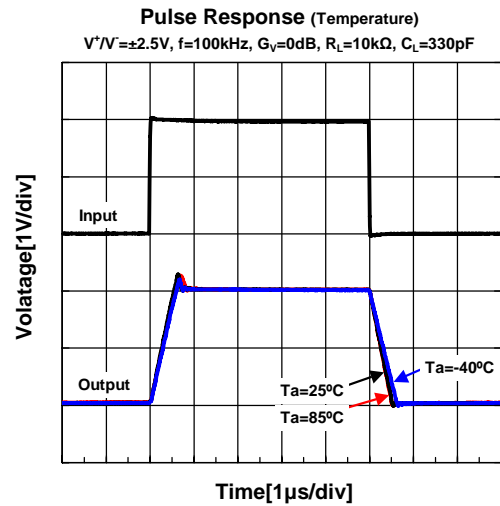
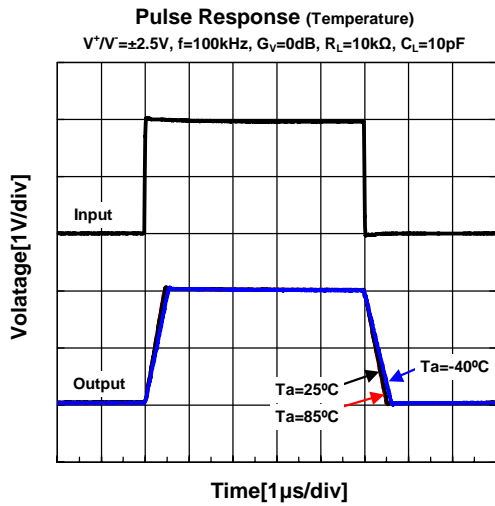
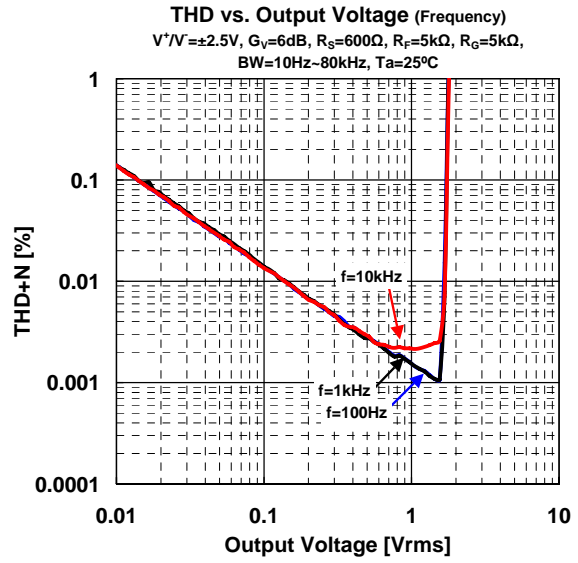
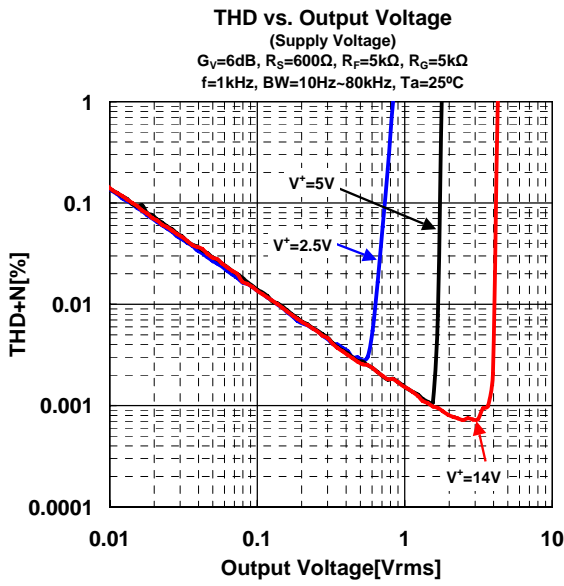

## ■ MEMO

[CAUTION]  
The specifications on this data book are only given for information, without any guarantee as regards either mistakes or omissions. The application circuits in this data book are described only to show representative usages of the product and not intended for the guarantee or permission of any right including the industrial rights.