

### FEATURES

Monitoring of 12 V, 5 V, 3.3 V and 2.8 V Supplies in Parallel

Auxiliary Sensor Inputs

Low Power: 25  $\mu$ A Typical

Internal Comparator Hysteresis

Power Supply Glitch Immunity

$V_{CC}$  from 2.5 V to 6 V

Guaranteed from  $-40^{\circ}\text{C}$  to  $+85^{\circ}\text{C}$

No External Components

16-Pin Narrow SOIC Package (150 Mil Wide)

### APPLICATIONS

Microprocessor Systems

Computers

Controllers

Intelligent Instruments

Network Systems

### GENERAL DESCRIPTION

The ADM9264 is a Quad Supply Monitor IC which simultaneously monitors four separate power supply voltages and outputs error signals if any of the supply voltages go out of limits. It is designed for PC supply monitoring but can be used on any system where multiple power supplies require monitoring. The error output signals are available individually and also gated into a common output - PWROK. Auxiliary inputs ERRX,  $\overline{\text{ERRY}}$  are provided which are also gated into the main PWROK signal. These inputs allow signals from other monitoring circuits (for example temperature sensor, alarm, etc.) to be linked into the ADM9264.

Each power supply monitor circuit uses a proprietary window comparator design whereby a three resistor network is used in conjunction with two comparators and a single precision voltage reference to check if the supply is within its required operating tolerance. An added feature of this design is that the power supply voltages being monitored can be higher than the power supply voltage to the monitoring IC itself.

### FUNCTIONAL BLOCK DIAGRAM

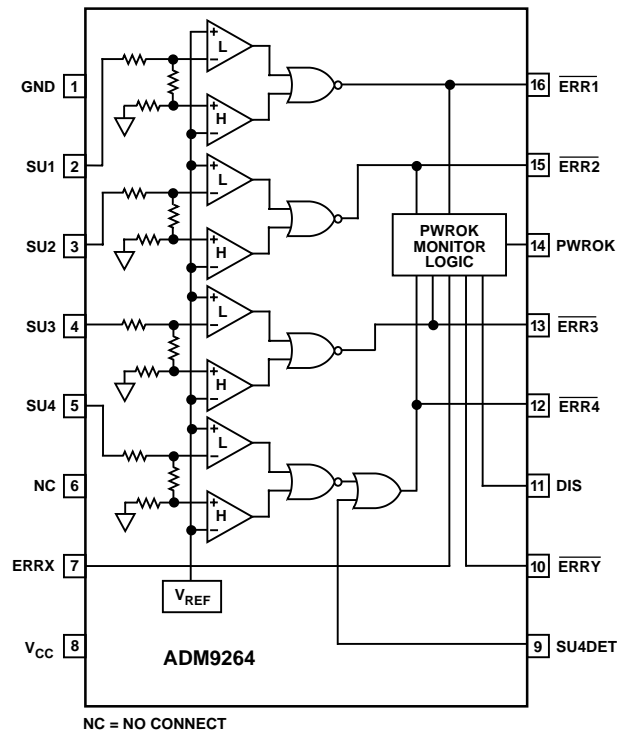

Analog Devices' experience in the design of power supply supervisory circuits is used to provide an optimum solution for the overall circuit in terms of cost, performance and power consumption. Key features of the design include the incorporation of hysteresis and glitch immunity into the comparators, which minimizes the possibility of spurious triggering by noise spikes on the supplies being monitored.

The part is manufactured on one of Analog Devices' proprietary BiCMOS processes, which also includes high performance thin film resistors to achieve the accuracy required for the precision voltage reference and power supply high and low trip points.

### REV. 0

Information furnished by Analog Devices is believed to be accurate and reliable. However, no responsibility is assumed by Analog Devices for its use, nor for any infringements of patents or other rights of third parties which may result from its use. No license is granted by implication or otherwise under any patent or patent rights of Analog Devices.

One Technology Way, P.O. Box 9106, Norwood, MA 02062-9106, U.S.A.  
Tel: 617/329-4700 World Wide Web Site: <http://www.analog.com>  
Fax: 617/326-8703 © Analog Devices, Inc., 1997

# ADM9264—SPECIFICATIONS (V<sub>CC</sub> = Full Operating Range, T<sub>A</sub> = T<sub>MIN</sub> to T<sub>MAX</sub> unless otherwise noted)

Parameter	Min	Typ	Max	Units	Test Conditions/Comments
OPERATING TEMPERATURE RANGE	-40		85	°C	Industrial (A Version)
V <sub>CC</sub> SUPPLY VOLTAGE	2.5		6.0	V	
V <sub>CC</sub> SUPPLY CURRENT		25	75	μA	Digital Inputs = V <sub>CC</sub> /GND
SU1 INPUT RESISTANCE	200	240		kΩ	I IN ~ 50 μA when SU1 = 12 V
SU2 INPUT RESISTANCE	85	100		kΩ	I IN ~ 50 μA when SU2 = 5 V
SU3 INPUT RESISTANCE	55	66		kΩ	I IN ~ 50 μA when SU3 = 3.3 V
SU4 INPUT RESISTANCE	45	56		kΩ	I IN ~ 50 μA when SU4 = 2.8 V
SU1 HIGH TRIP POINT	12.72	12.96	13.2	V	Measured with SU1 Rising
SU2 HIGH TRIP POINT	5.35	5.45	5.55	V	Measured with SU2 Rising
SU3 HIGH TRIP POINT	3.53	3.60	3.66	V	Measured with SU3 Rising
SU4 HIGH TRIP POINT	2.94	3.00	3.05	V	Measured with SU4 Rising
SU1 LOW TRIP POINT	10.8	11.04	11.28	V	Measured with SU1 Falling
SU2 LOW TRIP POINT	4.45	4.55	4.65	V	Measured with SU2 Falling
SU3 LOW TRIP POINT	2.94	3.00	3.07	V	Measured with SU3 Falling
SU4 LOW TRIP POINT	2.55	2.60	2.66	V	Measured with SU4 Falling
SU1 HYSTERESIS		320		mV	Measured at SU1
SU2 HYSTERESIS		130		mV	Measured at SU2
SU3 HYSTERESIS		90		mV	Measured at SU3
SU4 HYSTERESIS		80		mV	Measured at SU4
GLITCH IMMUNITY		10		μs	100 mV Glitch on V <sub>CC</sub> or SU1-4
PROPAGATION DELAY		10		μs	Delay from Supply Going Outside Tolerance until Output Changes
DIGITAL INPUT LOW, V <sub>IL</sub>			0.8	V	4.0 V < V <sub>CC</sub> < 6 V
DIGITAL INPUT HIGH, V <sub>IH</sub>	2.4			V	4.0 V < V <sub>CC</sub> < 6 V
DIGITAL INPUT LOW, V <sub>IL</sub>			0.5	V	2.5 V < V <sub>CC</sub> < 4.0 V
DIGITAL INPUT HIGH, V <sub>IH</sub>	2.0			V	2.5 V < V <sub>CC</sub> < 4.0 V
DIGITAL INPUT CURRENT	-1		+1	μA	(ERRX, $\overline{\text{ERRY}}$ , DIS)
OPEN DRAIN OUTPUT LOW			0.4	V	10 kΩ External to Positive Supply V+
OPEN DRAIN OUTPUT HIGH	V+ -0.25			V	10 kΩ External to Positive Supply V+
SUPPLY RANGE FOR V+	2.5		6.0	V	V+ Can Be Different from V <sub>CC</sub>

Specifications subject to change without notice.

## ABSOLUTE MAXIMUM RATINGS\*

(T<sub>A</sub> = +25°C unless otherwise noted)

V <sub>CC</sub> .....	-0.3 V to +6 V
SU1, SU2, SU3, SU4 .....	-0.3 V to +15 V
All Other Inputs .....	-0.3 V to V <sub>CC</sub> + 0.3 V
All Outputs .....	-0.3 V to +6 V
Output Current ERR1-4, PWROK .....	20 mA
Operating Temperature Range	
Industrial (A Version) .....	-40°C to +85°C
Power Dissipation, R-16A .....	700 mW
θ <sub>JA</sub> Thermal Impedance .....	110°C/W
Lead Temperature (Soldering, 10 secs) .....	+300°C
Vapor Phase (60 secs) .....	+215°C
Infrared (15 secs) .....	+220°C
Storage Temperature Range .....	-65°C to +150°C

\*Stresses above those listed under Absolute Maximum Ratings may cause permanent damage to the device. This is a stress rating only; functional operation of the device at these or any other conditions above those listed in the operational sections of this specification is not implied. Exposure to absolute maximum ratings for extended periods of time may affect device reliability.

## ORDERING GUIDE

Model	Temperature Range	Package Option <sup>1</sup>
ADM9264ARN	-40°C to +85°C	R-16A
ADM9264ARN-REEL <sup>2</sup>	-40°C to +85°C	R-16A
ADM9264ARN-REEL7 <sup>3</sup>	-40°C to +85°C	R-16A

### NOTES

<sup>1</sup>R = Small Outline IC.

<sup>2</sup>2500 devices per reel.

<sup>3</sup>1000 devices per reel.

## CAUTION

ESD (electrostatic discharge) sensitive device. Electrostatic charges as high as 4000 V readily accumulate on the human body and test equipment and can discharge without detection. Although the ADM9264 features proprietary ESD protection circuitry, permanent damage may occur on devices subjected to high energy electrostatic discharges. Therefore, proper ESD precautions are recommended to avoid performance degradation or loss of functionality.



# ADM9264

## PIN CONFIGURATION

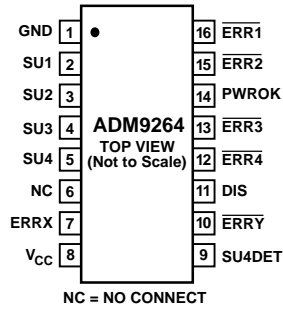

## PIN FUNCTION DESCRIPTIONS

Pin No.	Mnemonic	Function
1	GND	Ground.
2	SU1	Supply to Be Monitored. 12 V $\pm$ 6%.
3	SU2	Supply to Be Monitored. 5 V $\pm$ 7%.
4	SU3	Supply to Be Monitored. 3.3 V $\pm$ 7%.
5	SU4	Supply to Be Monitored. 2.8 V $\pm$ 5%.
6	NC	No Connect.
7	ERRX	Digital Input. Auxiliary error input (active high). When High it forces PWROK to be Low.
8	V <sub>CC</sub>	Supply Monitor IC Power Supply. Can be powered off any power supply between 2.5 V and 6 V including one of the supplies being monitored (except for SU1).
9	SU4DET	Digital Input. Disable SU4. When High it causes $\overline{\text{ERR4}}$ to pull high through 10 k $\Omega$ external resistor to a positive power supply.
10	$\overline{\text{ERRY}}$	Digital Input. Auxiliary error input (active low). When Low it forces PWROK to be Low.
11	DIS	Digital Input. When High it forces PWROK to be High.
12	$\overline{\text{ERR4}}$	Open Drain Output. Pulls high through 10 k $\Omega$ external resistor to a positive power supply when SU4DET is high or SU4 is within its required tolerance of 2.8 V $\pm$ 5%. Pulls Low otherwise.
13	$\overline{\text{ERR3}}$	Open Drain Output. Low when SU3 is outside its required tolerance of 3.3 V $\pm$ 7%. Pulls High otherwise through 10 k $\Omega$ external resistor to a positive power supply.
14	PWROK	Open Drain Output. Pulls High through external 10 k $\Omega$ resistor to a positive power supply when SU1, SU2, SU3 and SU4 are all within their required tolerances and when $\overline{\text{ERRY}}$ is High and when ERRX is Low. Pulls Low otherwise.
15	$\overline{\text{ERR2}}$	Open Drain Output. Low when SU2 is outside its required tolerance of 5 V $\pm$ 7%. Pulls High otherwise through 10 k $\Omega$ external resistor to a positive power supply.
16	$\overline{\text{ERR1}}$	Open Drain Output. Low when SU1 is outside its required tolerance of 12 V $\pm$ 6%. Pulls High otherwise through 10 k $\Omega$ external resistor to a positive power supply.

## CIRCUIT INFORMATION

### Monitor Inputs SU1 to SU4

The ADM9264 is provided with four analog inputs, SU1 to SU4, to monitor supply voltages of +12 V, +5 V, +3.3 V and +2.8 V. Each input is connected to a window comparator consisting of a pair of voltage comparators and a two-input NOR gate. Each pair of comparators obtains a reference voltage from a precision internal reference, and each input to be monitored is connected to the comparators via a precision, thin film attenuator, whose resistor ratios determine the trip points of each comparator. As the input voltages are attenuated before reaching the comparators, they may exceed the supply voltage of the ADM9264 without exceeding the common-mode or differential input range of the comparators.

When the input voltage is within limits, the outputs of both comparators are low, so the output of the NOR gate is high. If the voltage on the inverting input of the low comparator falls below the reference voltage, or the voltage on the noninverting input of the high comparator rises above the reference voltage, the output of the NOR gate will go low.

### Error Outputs

Error outputs  $\overline{ERR1}$  to  $\overline{ERR4}$  are open-drain outputs that are OFF (high) when the corresponding input voltage is within limits and ON (low) when the input is out of limit. Each error output requires a 10 k $\Omega$  pull-up resistor to a positive supply, which may be different from  $V_{CC}$  if required. The open-drain construction allows two or more of these outputs to be wire-ANDed together if required.

### Auxiliary Inputs $ERRX$ , $\overline{ERRY}$

$ERRX$  and  $\overline{ERRY}$  are TTL-compatible auxiliary inputs that allow external signals such as temperature alarms to be linked into the ADM9264.  $ERRX$  is active high and forces PWROK low when it is high.  $\overline{ERRY}$  is active low and forces PWROK low when it is low.

### DIS Input

The disable input, DIS, is a TTL-compatible input. It overrides all other inputs to the PWROK logic and forces PWROK high when it is high.

### SU4DET Input

SU4DET is a TTL-compatible input that disables the  $\overline{ERR4}$  output, causing  $\overline{ERR4}$  to go high when SU4DET is high. This allows the SU4 input to be disabled easily for systems that do not have a 2.8 V supply.

### PWROK Output

The PWROK output combines the four error outputs and the auxiliary inputs to give a common "Power OK" output. If the four error outputs are high,  $ERRX$  is low,  $\overline{ERRY}$  is high and DIS is low then PWROK is high, otherwise PWROK is low. PWROK is an open-drain output and requires a 10K pull-up resistor to a positive supply, which may be different from  $V_{CC}$  if required. A truth table for the PWROK output is following.

Truth Table

DIS	$ERRX$	$\overline{ERRY}$	$ERR4$	$ERR3$	$ERR2$	$ERR1$	PWROK
0	0	1	1	1	1	1	1
0	X	X	X	X	X	0	0
0	X	X	X	X	0	X	0
0	X	X	X	0	X	X	0
0	X	0	X	X	X	X	0
0	1	X	X	X	X	X	0
1	X	X	X	X	X	X	1

X = don't care.

### Power Supply $V_{CC}$

The ADM9264 can be powered from any supply voltage between 2.5 V and 6 V. This includes any of the supply voltages apart from that connected to SU1, since this is greater than 6 V.

The logic outputs are open-drain and take their output high level from the voltage connected to the pull-up resistor, so they are not dependent on the value of  $V_{CC}$ .

# Typical Performance Characteristics—ADM9264

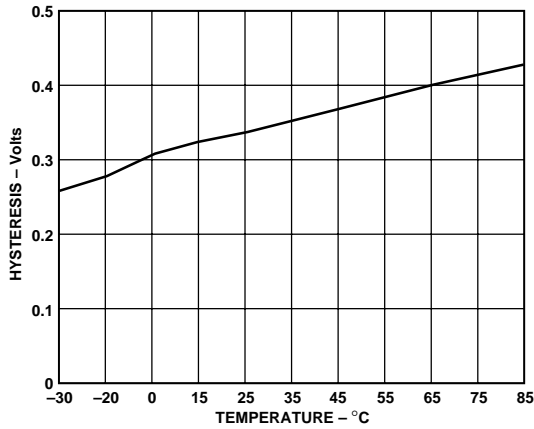

Figure 1. Hysteresis vs. Temperature for SU1—Low to High

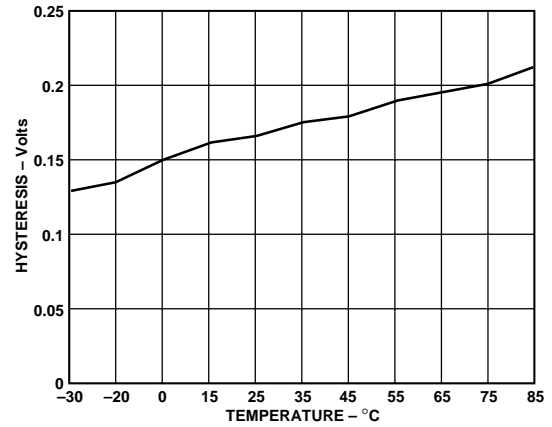

Figure 4. Hysteresis vs. Temperature for SU2—High to Low

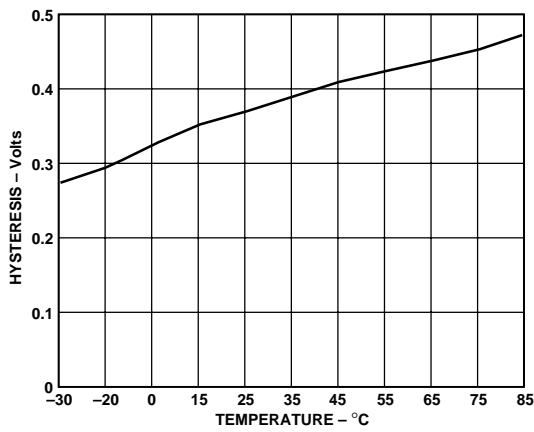

Figure 2. Hysteresis vs. Temperature for SU1—High to Low

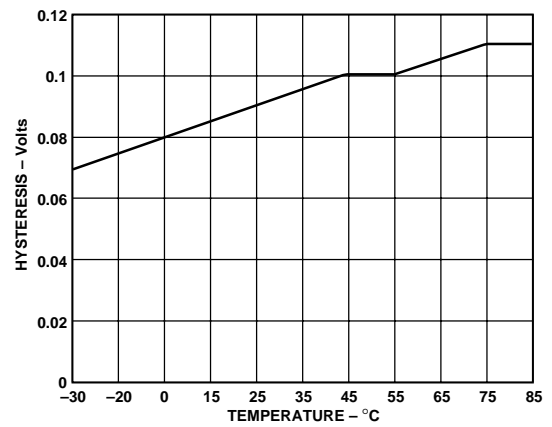

Figure 5. Hysteresis vs. Temperature for SU3—Low to High

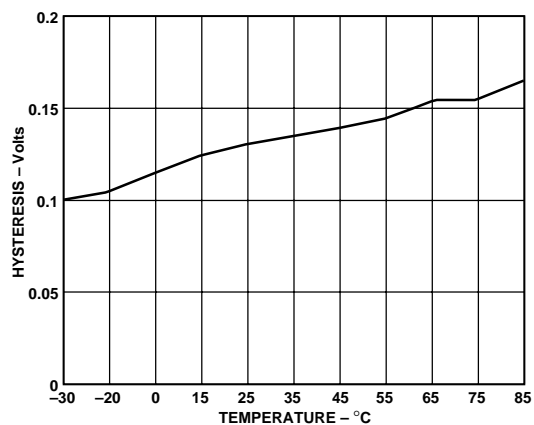

Figure 3. Hysteresis vs. Temperature for SU2—Low to High

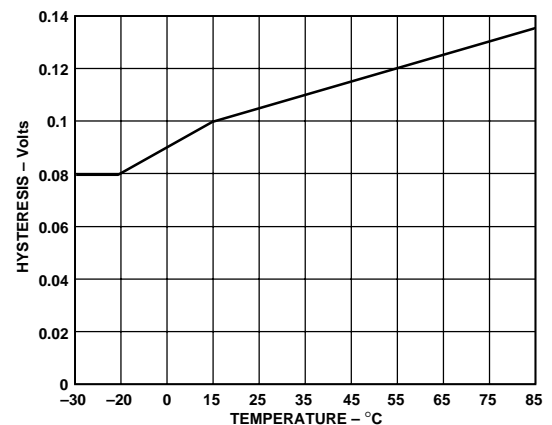

Figure 6. Hysteresis vs. Temperature for SU3—High to Low

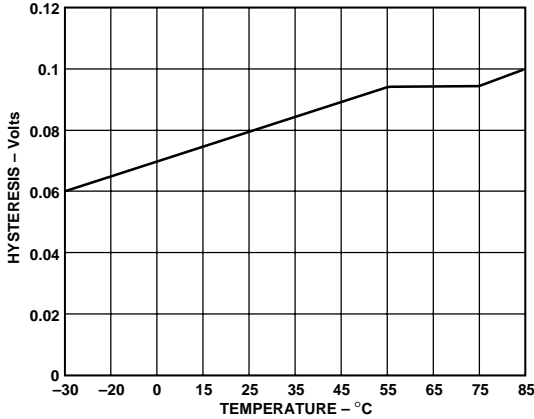

Figure 7. Hysteresis vs. Temperature for SU4—Low to High

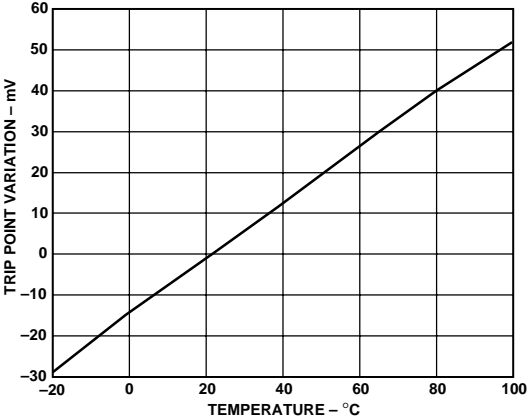

Figure 10. Variation of SU1 Low Trip Point With Temperature

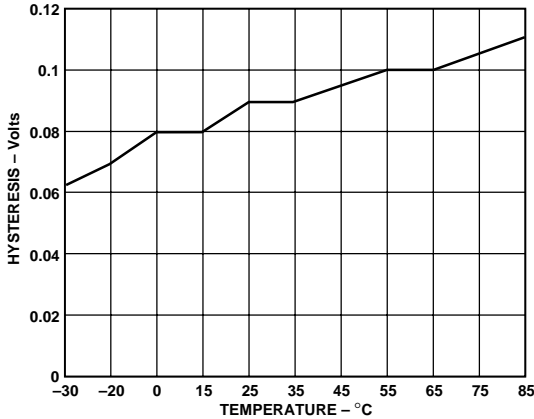

Figure 8. Hysteresis vs. Temperature for SU4—High to Low

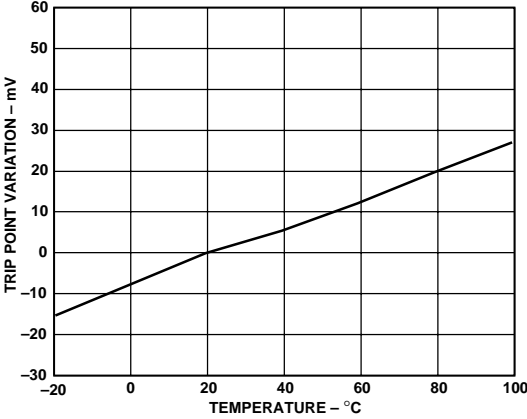

Figure 11. Variation of SU2 High Trip Point With Temperature

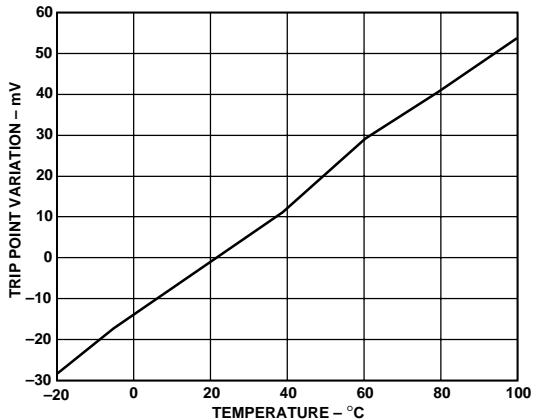

Figure 9. Variation of SU1 High Trip Point With Temperature

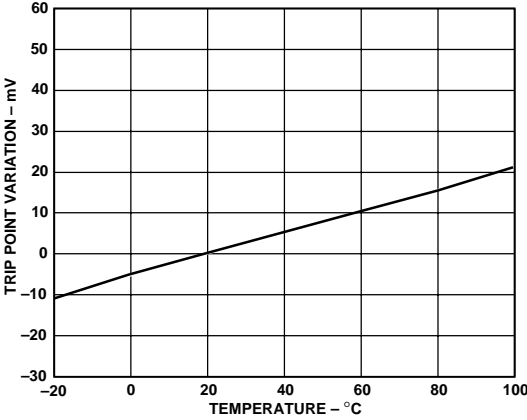

Figure 12. Variation of SU2 Low Trip Point With Temperature

# ADM9264

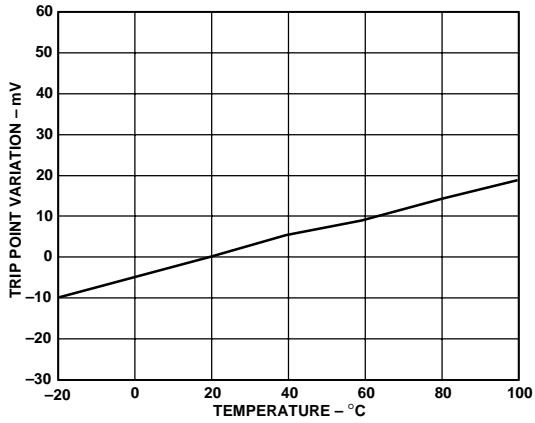

Figure 13. Variation of SU3 High Trip Point With Temperature

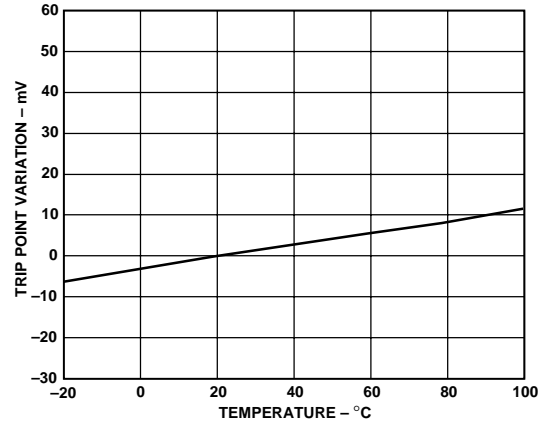

Figure 16. Variation of SU4 Low Trip Point With Temperature

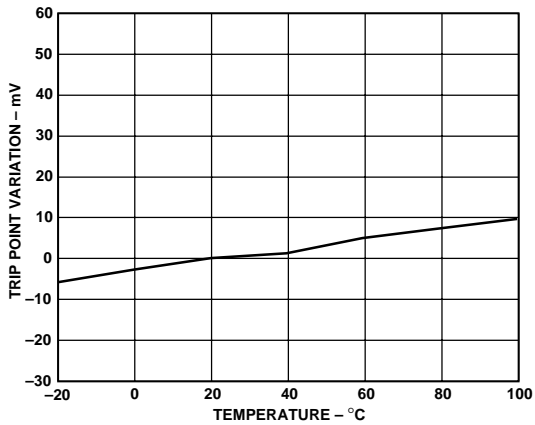

Figure 14. Variation of SU3 Low Trip Point With Temperature

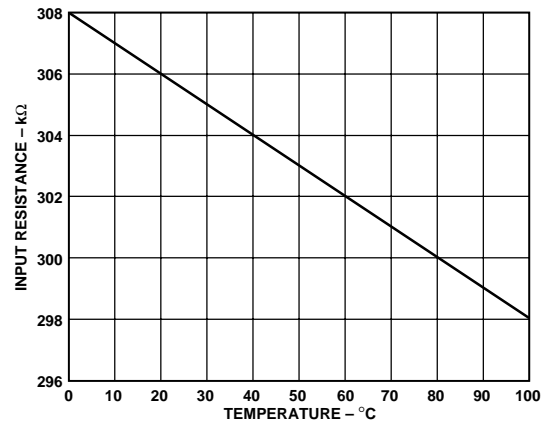

Figure 17. SU1 Input Resistance vs. Temperature

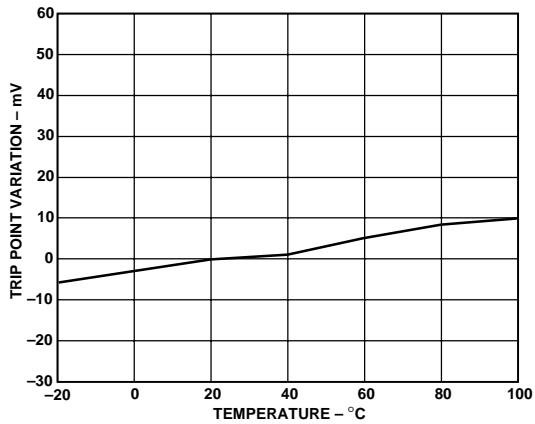

Figure 15. Variation of SU4 High Trip Point With Temperature

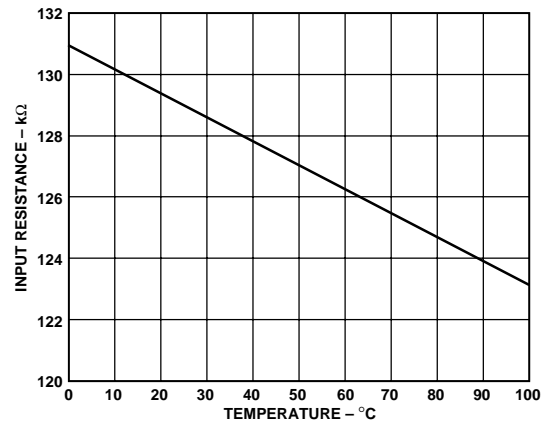

Figure 18. SU2 Input Resistance vs. Temperature



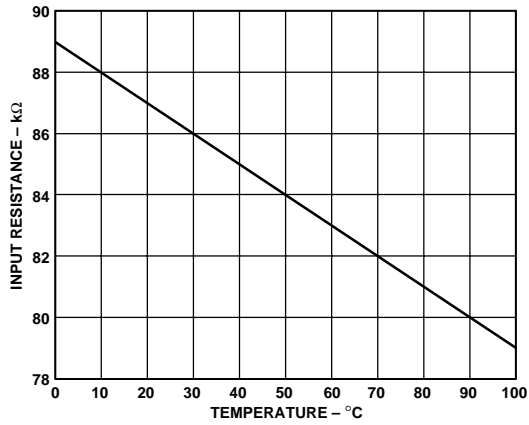

Figure 19. SU3 Input Resistance vs. Temperature

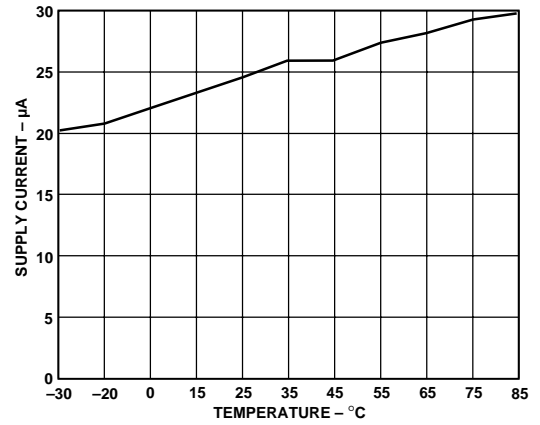

Figure 21. Supply Current vs. Temperature

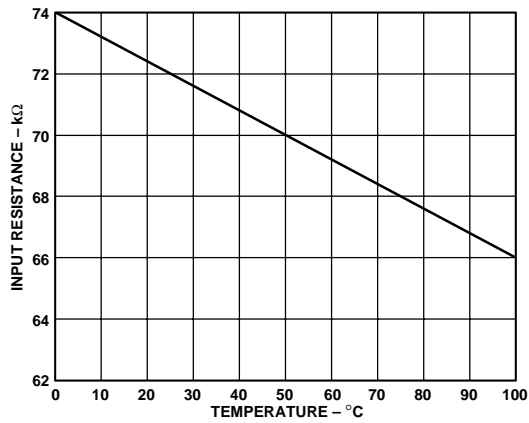

Figure 20. SU4 Input Resistance vs. Temperature

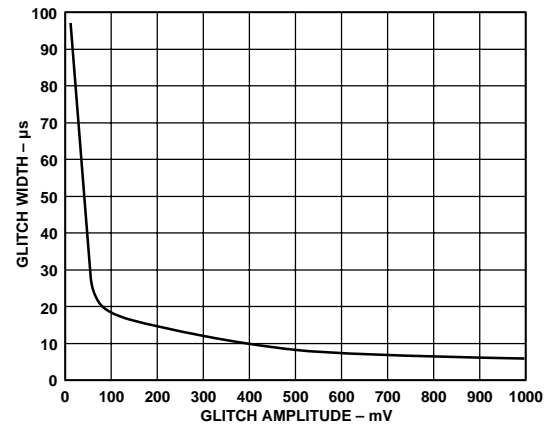

Figure 22. Glitch Immunity

# ADM9264

## APPLICATIONS

A typical application of the ADM9264 is shown in Figure 23. The analog inputs SU1 to SU4 are connected to the four power supply outputs of a system to monitor the supply voltages.

One of the digital inputs,  $\overline{\text{ERRY}}$ , is connected to a temperature sensor such as the TMP01 or AD22105. The trip point of the overtemperature comparator is set by  $R_{\text{SET}}$  so that the output goes low when the temperature exceeds safe limits. (See the appropriate Analog Devices data sheet for more information on these devices.)

The other digital input,  $\text{ERRX}$ , is connected to a fan failure sensor. This can be something as simple as a vane switch mounted in the fan air flow, which opens if the air flow fails.

The digital outputs of the ADM9264 are interfaced to the system microprocessor through the GPIO lines or via an I/O adapter chip. Depending on the level of fault diagnostics required in the system, the four error outputs ( $\overline{\text{ERR1}}$  to  $\overline{\text{ERR4}}$ ) corresponding to the analog inputs SU1 to SU4 can be individually connected to the I/O chip to give specific indication of which supply voltage has failed, while the  $\text{PWROK}$  output indicates an overtemperature or system cooling failure. Alternatively, the  $\text{PWROK}$  output can be used alone to give a nonspecific failure indication.

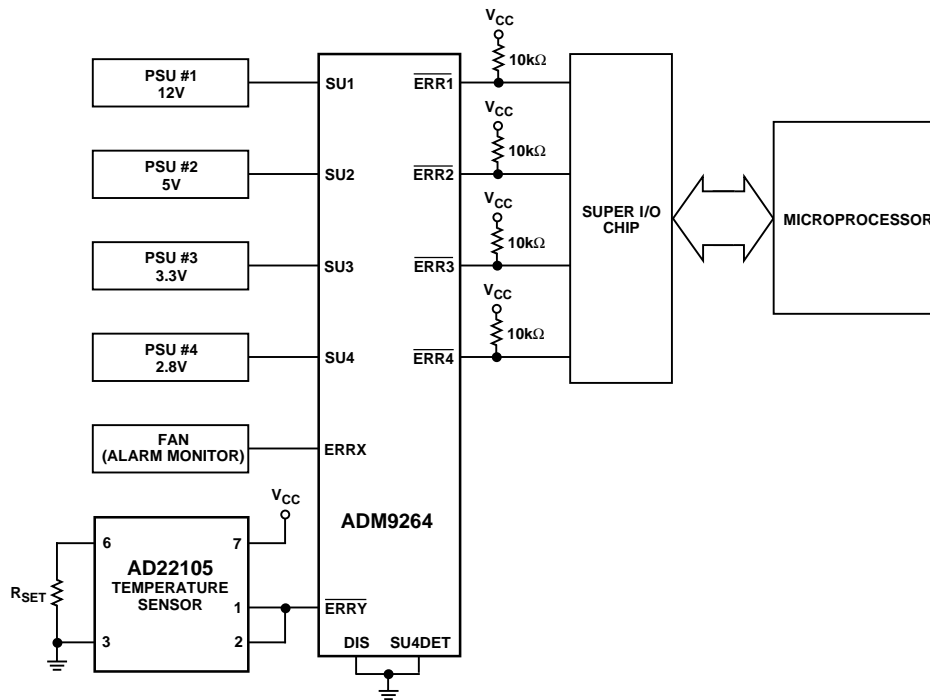

Figure 23. Typical Application of ADM9264

**OUTLINE DIMENSIONS**

Dimensions shown in inches and (mm).

**16-Lead Narrow SOIC  
(R-16A)**

