

LMC2001

High Precision, 6MHz Rail-To-Rail Output Operational Amplifier

General Description

The LMC2001 is a new precision amplifier that offers unprecedented accuracy and stability at an affordable price and is offered in miniature (SOT23-5) package. This device utilizes patented techniques to measure and continually correct the input offset error voltage. The result is an amplifier which is ultra stable over time, and temperature. It has excellent CMRR and PSRR ratings, and does not exhibit the familiar 1/f voltage and current noise increase that plagues traditional amplifiers. The combination of the LMC2001 characteristics makes it a good choice for transducer amplifiers, high gain configurations, ADC buffer amplifiers, DAC I-V conversion, and any other 5V application requiring precision and/or stability.

Other useful benefits of the LMC2001 are rail-to-rail output, low supply current of 750µA, and wide gain-bandwidth product of 6MHz. The LMC2001 comes in 5 pin SOT23 and 8 pin SOIC. These extremely versatile features found in the LMC2001 provide high performance and ease of use.

Features

(Vs = 5V, RL = 10K to V+ /2, Typ. Unless Noted)

- Low Guaranteed Vos 40µV
- en With No 1/f 85nV/√Hz
- High CMRR 120dB
- High PSRR 120dB
- High AVOL 137dB
- Wide Gain-Bandwidth Product 6MHz
- High Slew Rate 5V/µs
- Low Supply Current 750µA
- Rail-To-Rail Output 30mV from either rail
- No External Capacitors Required

Applications

- Precision Instrumentation Amplifiers
- Thermocouple Amplifiers
- Strain Gauge Bridge Amplifier

Connection Diagrams

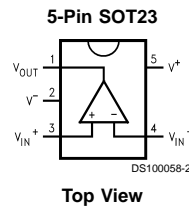
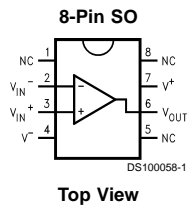

Ordering Information

Package	Temperature Range		Package Marking	Transport Media	NSC Drawing
	Commercial 0°C to +70°C	Industrial -40°C to +85°C			
8-pin Small Outline		LMC2001AIM	LMC2001AIM	Rails	M08A
		LMC2001AIMX		2.5k Units Tape and Reel	
5-pin SOT23-5	LMC2001ACM5		A09A	1k Units Tape and Reel	MA05B
	LMC2001ACM5X			3k Units Tape and Reel	

LMC2001 High Precision, 6MHz Rail-To-Rail Output Operational Amplifier

Absolute Maximum Ratings (Note 1)

If Military/Aerospace specified devices are required, please contact the National Semiconductor Sales Office/Distributors for availability and specifications.

ESD Tolerance (Note 2)	
Human Body Model	2500V
Machine Model	150V
Differential Input Voltage	± Supply Voltage
Supply Voltage (V ⁺ - V ⁻)	5.6V
Current At Input Pin	30mA
Current At Output Pin	30mA
Current At Power Supply Pin (Note 3)	50mA

Lead Temperature (soldering, 10 sec) 260°C

Storage Temperature Range	-65°C to 150°C
Junction Temperature (T _J) (Note 4)	150°C

Operating Ratings (Note 1)

Supply voltage	4.75V to 5.25V
Temperature Range	
LMC2001AI	-40°C ≤ T _J ≤ 85°C
LMC2001AC	0°C ≤ T _J ≤ 70°C
Thermal resistance (θ _{JA})	
M Package, 8-pin Surface Mount	180°C /W
M5 Package, SOT23-5	274°C /W

DC Electrical Characteristics

Unless otherwise specified, all limits guaranteed for T_J = 25°C, V⁺ = 5V, V⁻ = 0V, V_{CM} = 2.5V, V_O = 2.5V and R_L > 1MΩ. **Boldface** limits apply at the temperature extremes.

Symbol	Parameter	Conditions	Typ (Note 5)	Limit (Note 6)	Units
V _{OS}	Input Offset Voltage	(Note 11)	0.5	40 60	μV max
	Offset Calibration Time		5	30	ms
TCV _{OS}	Input Offset Voltage	(Note 12)	0.015		μV/°C
	Long-Term Offset Drift	(Note 8)	0.006		μV/month
	Lifetime V _{OS} drift	(Note 8)	2.5	5	μV Max
I _{IN}	Input Current	(Note 9)	-3		pA
I _{OS}	Input Offset Current		6		pA
R _{IND}	Input Differential Resistance		9		MΩ
CMRR	Common Mode Rejection Ratio	0V ≤ V _{CM} ≤ 3.5V	120	100	dB min
		0.1V ≤ V _{CM} ≤ 3.5V	110	90	dB min
PSRR	Power Supply Rejection Ratio	4.75V ≤ V ⁺ ≤ 5.25V	120	95 90	dB min
A _{VOL}	Large Signal Voltage Gain (Note 7)	R _L = 10kΩ	137	105 100	dB min
		R _L = 2kΩ	128	95 90	
V _O	Output Swing	R _L = 10kΩ to 2.5V V _{IN} (diff) = ±0.5V	4.975	4.955 4.955	V min
			0.030	0.060 0.060	V max
		R _L = 2kΩ to 2.5V V _{IN} (diff) = ±0.5V	4.936		V
			0.075		V
I _O	Output Current	Sourcing, V _O = 0V V _{IN} (diff) = ±0.5V	5.9	4.1 1.5	mA min
		Sinking, V _O = 5V V _{IN} (diff) = ±0.5V	14.5	4.5 1.5	mA min
I _S	Supply Current		0.75	1.0 1.2	mA max

AC Electrical Characteristics

$T_J = 25^\circ\text{C}$, $V^+ = 5\text{V}$, $V^- = 0\text{V}$, $V_{\text{CM}} = 2.5\text{V}$, $V_O = 2.5\text{V}$, and $R_L > 1\text{M}\Omega$.

Symbol	Parameter	Conditions	Typ (Note 5)	Units	
SR	Slew Rate	$A_V = +1$, $V_{\text{in}} = 3.5\text{Vpp}$	5	$\text{V}/\mu\text{s}$	
GBW	Gain-Bandwidth Product		6	MHz	
θ_m	Phase Margin		75	Deg	
G_m	Gain Margin		12	dB	
e_n	Input-Referred Voltage Noise	$f = 0.1\text{Hz}$	85	$\text{nV}/\sqrt{\text{Hz}}$	
$e_{\text{n,p-p}}$	Input-Referred Voltage Noise	$R_S = 100\Omega$, DC to 10Hz	1.6	μVpp	
i_n	Input-Referred Current Noise	$f = 0.1\text{Hz}$	180	$\text{fA}/\sqrt{\text{Hz}}$	
THD	Total Harmonic Distortion	$f = 1\text{kHz}$, $A_V = -2$ $R_L = 10\text{k}\Omega$, $V_O = 4.5\text{Vpp}$	0.02	%	
trec	Input Overload Recovery Time		50	ms	
T_S	Output Settling time	(Note 10) $A_V = +1$, 1V step	1% 0.1% 0.01%	250 400 3200	ns
		(Note 10) $A_V = -1$, 1V step	1% 0.1% 0.01%	80 860 1400	

Note 1: Absolute Maximum Ratings indicate limits beyond which damage to the device may occur. Operating Ratings indicate conditions for which the device is intended to be functional, but specific performance is not guaranteed. For guaranteed specifications and test conditions, see the Electrical Characteristics.

Note 2: Human body model, 1.5k Ω in series with 100pF. Machine model, 200 Ω in series with 100pF.

Note 3: Output currents in excess of $\pm 30\text{mA}$ over long term may adversely affect reliability.

Note 4: The maximum power dissipation is a function of $T_{\text{J(max)}}$, θ_{JA} , and T_A . The maximum allowable power dissipation at any ambient temperature is $P_D = (T_{\text{J(max)}} - T_A)/\theta_{\text{JA}}$. All numbers apply for packages soldered directly onto a PC board.

Note 5: Typical values represent the most likely parametric norm.

Note 6: All limits are guaranteed by testing or statistical analysis, unless otherwise noted.

Note 7: $V^+ = 5\text{V}$, $V_{\text{CM}} = 2.5\text{V}$, and R_L connected to 2.5V. For Sourcing tests, $2.5\text{V} \leq V_O \leq 4.8\text{V}$. For Sinking tests, $0.2\text{V} \leq V_O \leq 2.5\text{V}$.

Note 8: Guaranteed Vos Drift is based on 280 devices operated for 1000 hrs at 150°C (equivalent to 30 years 55°C).

Note 9: Guaranteed by design only.

Note 10: Settling times shown correspond to the worse case (positive or negative step) and does not include slew time. See the Application Note section for test schematic.

Note 11: The limits are set by the accuracy of high speed automatic test equipment. For the typical V_{OS} distribution, see the curve on page 4.

Note 12: Precision bench measurement of more than 300 units. More than 65% of units had less than 15nV/°C V_{OS} drift.

Typical Performance Characteristics

$T_A=25^\circ\text{C}$, $V_S=5\text{V}$ unless otherwise specified.

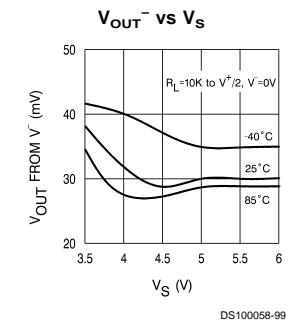
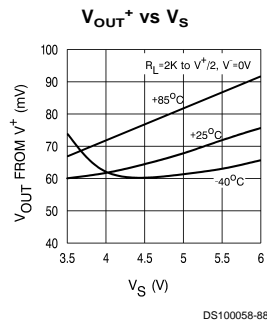
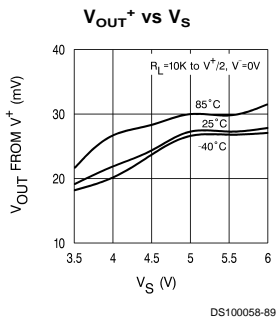
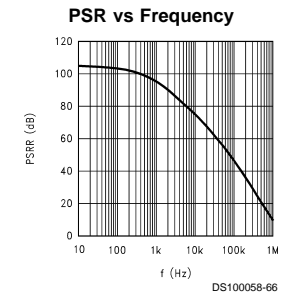
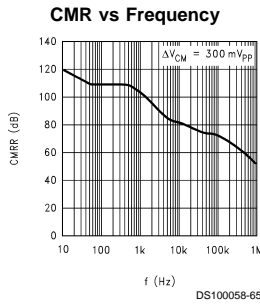
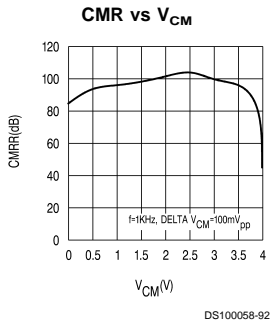
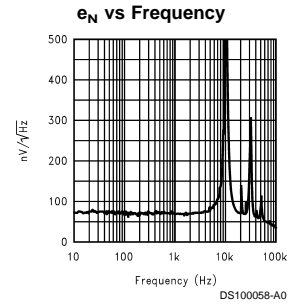
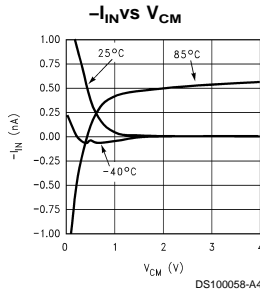
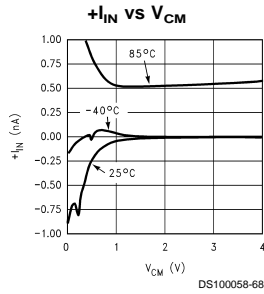
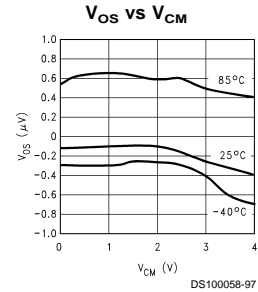
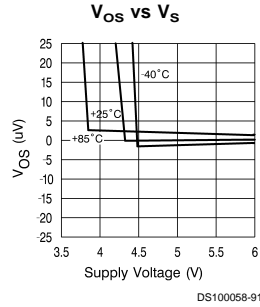
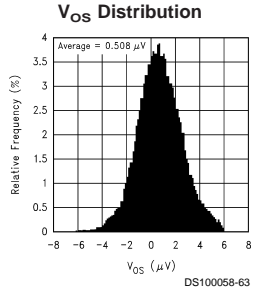

Typical Performance Characteristics (Continued)

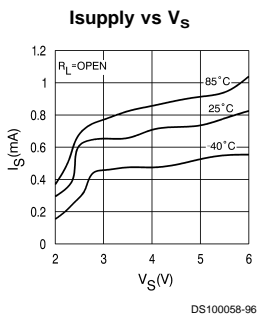
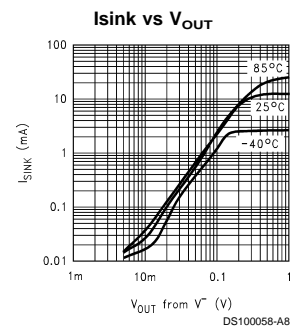
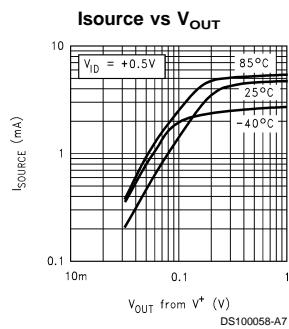
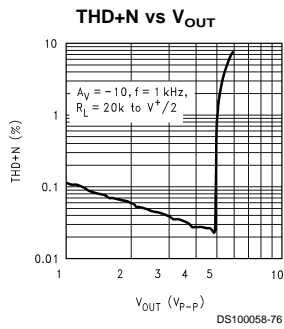
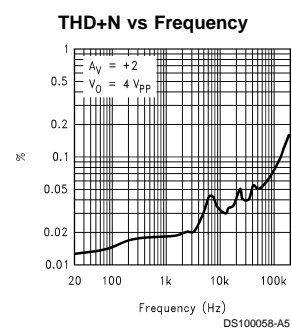
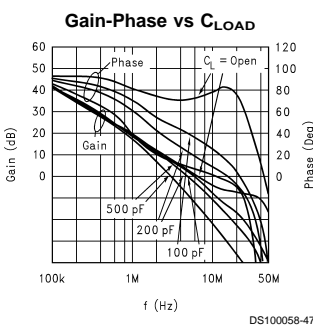
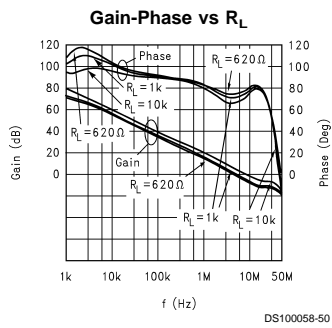
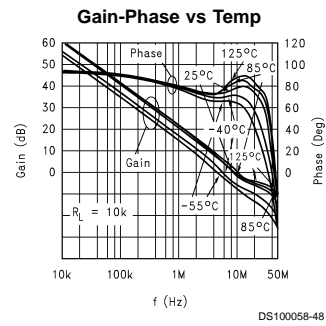
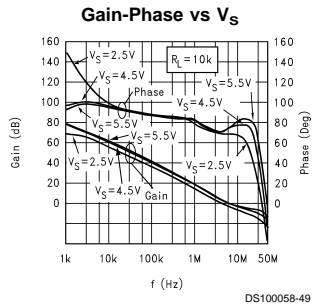
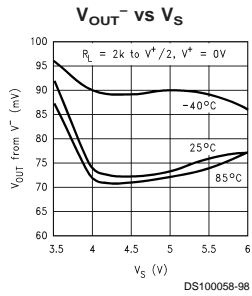

Application Notes

The Benefits of LMC2001

No 1/f Noise

Using patented methods, the LMC2001 eliminates the 1/f noise present in other amplifiers. This noise which increases as frequency decreases is a major source of measurement error in all DC coupled measurements. Low frequency noise appears as a constantly changing signal in series with any measurement being made. As a result, even when the measurement is made rapidly, this constantly changing noise signal will corrupt the result. The value of this noise signal can be surprisingly large. For example: If a conventional amplifier has a high frequency noise level of $10\text{nV}/\sqrt{\text{Hz}}$ and a noise corner of 10 Hz, the RMS noise at 0.001 Hz is $1\mu\text{V}/\sqrt{\text{Hz}}$

This is equivalent to a $6\mu\text{V}$ peak-to-peak error. In a circuit with a gain of 1000, this produces a 6mV peak-to-peak output error. This number of 0.001 Hz might appear unreasonably low but when a data acquisition system is operating for 17 minutes it has been on long enough to include this error. In this same time, the LMC2001 will only have a 0.51mV output error. This is more than 13.3 times less error.

Keep in mind that this 1/f error gets even larger at lower frequencies.

At the extreme, many people try to reduce this error by integrating or taking several samples of the same signal. This is also doomed to failure because the 1/f nature of this noise means that taking longer samples just moves the measurement into lower frequencies where the noise level is even higher.

The LMC2001 eliminates this source of error. The noise level is constant with frequency so that reducing the bandwidth reduces the errors caused by noise.

Another source of error that is rarely mentioned is the error voltages caused by the inadvertent thermocouples created when the common "Kovar type" package lead materials are soldered to a copper printed circuit board. These steel based leadframe materials can produce over $35\mu\text{V}/^\circ\text{C}$ when soldered onto a copper trace. This can result in thermocouple noise that is equal to the LMC2001 noise when there is a temperature difference of only 0.0014°C between the lead and the board!

For this reason, the leadframe of the LMC2001 is made of copper. This results in equal and opposite junctions which cancel this effect. The extremely small size of the SOT-23 package results in the leads being very close together. This further reduces the probability of temperature differences and hence decreases thermal noise.

Overload Recovery

The LMC2001 recovers from input overload much faster than most chopper stabilized opamps. Recovery, from driving the amplifier to 2X the full scale output, only requires about 50ms. Most chopper stabilized amplifiers will take from 250ms to several seconds to recover from this same overload. This is because large capacitors are used to store the unadjusted offset voltage.

The wide bandwidth of the LMC2001 enhances performance when it is used as an amplifier to drive loads that inject transients back into the output. A to Ds and multiplexers are examples of this type of load. To simulate this type of load, a pulse generator producing a 1V peak square wave was connected to the output through a 10pF capacitor. (Figure 1) The typical time for the output to recover to 1% of the applied

pulse is 80ns. To recover to 0.1% requires 860ns. This rapid recovery is due to the wide bandwidth of the output stage and large total GBW.

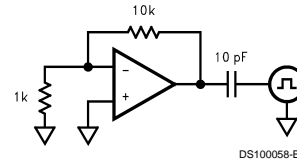

FIGURE 1.

No External Capacitors Required

The LMC2001 does not need external capacitors. This eliminates the problems caused by capacitor leakage and dielectric absorption, which can cause delays of several seconds from turn-on until the amplifier is settled.

More Benefits

The LMC2001 offers the benefits mentioned above and more. It is rail-to-rail output and consumes only $750\mu\text{A}$ of supply current while providing excellent DC and AC electrical performance. In DC performance, the LMC2001 achieves 120dB of CMRR, 120dB of PSRR and 137dB of open loop gain. In AC performance, the LMC2001 provides 6MHz of gain-bandwidth product and $5\text{V}/\mu\text{s}$ of slew rate.

How the LMC2001 Works

The LMC2001 uses new, patented techniques to achieve the high DC accuracy traditionally associated with chopper stabilized amplifiers without the major drawbacks produced by chopping. The LMC2001 continuously monitors the input offset and corrects this error. The conventional chopping process produces many mixing products, both sums and differences, between the chopping frequency and the incoming signal frequency. This mixing causes large amounts of distortion, particularly when the signal frequency approaches the chopping frequency. Even without an incoming signal, the chopper harmonics mix with each other to produce even more trash. If this sounds unlikely or difficult to understand, look at the plot (Figure 2), of the output of a typical (MAX432) chopper stabilized opamp. This is the output when there is no incoming signal, just the amplifier in a gain of -10 with the input grounded. The chopper is operating at about 150Hz, the rest is mixing products. Add an input signal and the mess gets much worse. Compare this plot with Figure 3 of the LMC2001. This data was taken under the exact same conditions. The auto zero action is visible at about 11kHz but note the absence of mixing products at other frequencies. As a result, the LMC2001 has very low distortion of 0.02% and very low mixing products.

Input Currents

The LMC2001 input current is different than standard bipolar or CMOS input currents in that it appears as a current flowing in one input and out the other. Under most operating conditions, these currents are in the picoamp level and will have little or no effect in most circuits. These currents increase to the nA level when the common-mode voltage is near the minus supply. (see the typical curves) At high temperatures such as 85°C , the input currents become larger, 0.5nA typical, and are both positive except when the V_{cm} is near V^- . If operation is expected at low common-mode voltages and high temperature, do not add resistance in series with the inputs to balance the impedances. Doing this can cause an increase in offset voltage.

Application Notes (Continued)

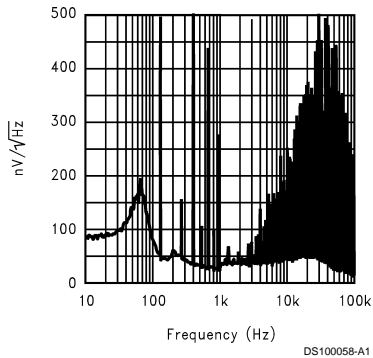

FIGURE 2.

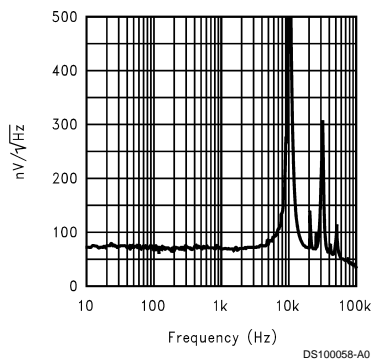

FIGURE 3.

This Strain-Gauge (*Figure 4*) amplifier provides high gain (1006 or 60 dB) with very low offset and drift. Using the resistors tolerance as shown, the worst case CMRR will be greater than 90 dB. The common-mode gain is directly related to the resistor mismatch and is independent of the differential gain that is set by R3. The worst case common-mode gain is -54 dB. This gain becomes even lower, improving CMRR, if the resistor ratio matching is improved.

$$A_{V \text{ Diff}} = 1 + \frac{R1}{R2} + \frac{2R1}{R3}$$

Extending Supply Voltages and Output Swing by Using a Composite Amplifier Configuration:

In cases where substantially higher output swing is required with higher supply voltages, arrangements like the ones shown in *Figure 5*, and *Figure 6* could be used (pin numbers shown are for SO-8 package). These configurations utilize the excellent DC performance of the LMC2001 while at the same time allow the superior voltage and frequency capabilities of the LM6171 to set the dynamic performance of the overall amplifier. For example, it is possible to achieve $\pm 12V$ output swing with 300MHz of overall GBW ($A_v=100$) while keeping the worst case output shift due to V_{os} less than 4mV. The LMC2001 output voltage is kept at about mid-point of its overall supply voltage and its input common mode voltage range allows the V^- terminal to be grounded in one case (*Figure 5*, inverting operation) and tied to a small non-critical negative bias in another (*Figure 6*, non-inverting op-

eration). Higher closed loop gains are also possible with a corresponding reduction in realizable bandwidth. Table 1 shows some other closed loop gain possibilities along with the measured performance in each case

Application Circuits

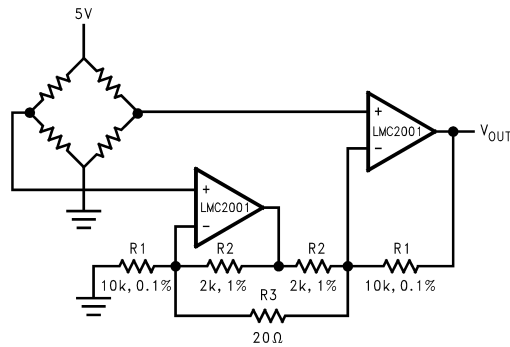

FIGURE 4. Single Supply Strain- Gauge Amplifier

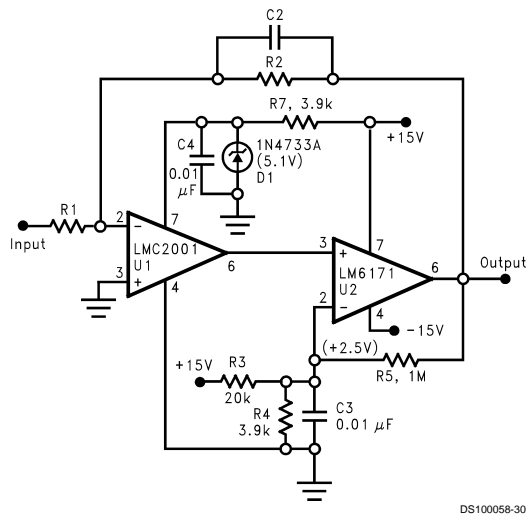
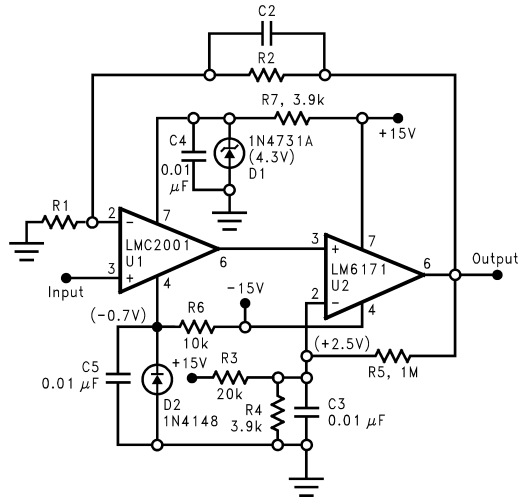

FIGURE 5. Inverting Composite Amplifier

Application Notes (Continued)



DS100058-31

FIGURE 6. Non-Inverting Composite Amplifier

TABLE 1. Composite Amplifier Measured Performance

Av	R1	R2	C2	BW	SR	e _{npp}
	(ohm)	(ohm)	(pF)	(MHz)	(V/us)	(mVpp)
50	200	10K	8	3.3	178	37
100	100	10K	10	2.5	174	70
100	1K	100K	0.67	3.1	170	70
500	200	100K	1.75	1.4	96	250
1000	100	100K	2.2	0.98	64	400

In terms of the measured output peak-to-peak noise, the following relationship holds between output noise voltage, e_{npp}, for different closed loop gain, A_v, settings, where -3dB Bandwidth is BW:

$$\frac{e_{npp1}}{e_{npp2}} = \sqrt{\frac{BW1}{BW2}} \cdot \frac{A_{v1}}{A_{v2}} \quad (1)$$

It should be kept in mind that in order to minimize the output noise voltage for a given closed loop gain setting, one could

minimize the overall bandwidth. As can be seen from Equation 1 above, the improvement in output noise has a square law relationship to the reduction in BW.

In the case of the inverting configuration, it is also possible to increase the input impedance of the overall amplifier, by raising the value of R1, without having to increase the feedback resistor, R2, to impractical values, by utilizing a "T" network as feedback. See the LMC6442 data sheet (Application Notes section) for more details on this.

LMC2001 as ADC Input Amplifier

The LMC2001 is a great choice for an amplifier stage immediately before the input of an A/D converter (AC or DC coupled) see Figure 7 and Figure 8 because of the following important characteristics:

- Very low offset voltage and offset voltage drift over time and temperature allow a high closed loop gain setting without introducing any short term or long term errors. For example, when set to a closed loop gain of 100 as the analog input amplifier of a 12 bit A/D converter, the overall conversion error over full operation temperature and 30 years life of the part (operating at 50°C) would be less than 5LSB.
- Fast large signal settling time to 0.01% of final value (1.4 us) allows 12 bit accuracy at 100KHz or more sampling rate.
- No flicker (1/f) noise means unsurpassed data accuracy over any measurement period of time, no matter how long. Consider the following opamp performance, based on a typical commercially available device, for comparison:

Opamp flatband noise	$8nV/\sqrt{Hz}$
$1/f^{0.94}$ corner frequency	100Hz
f(max)	100Hz
A _v	100
Measurement time	100 sec

The example above, will result in about 3mVpp (2.5LSB) of output noise contribution due to the opamp alone, compared to about 420 uVpp (less than 1LSB) when that opamp is replaced with the LMC2001 which has no 1/f contribution. If the measurement time is increased from 100 sec. to 1 hr., the improvement realized by using the LMC2001 would be a factor of about 44 times (18.5mVpp compared to 420uV when LMC2001 is used) mainly because the LMC2001 accuracy is not compromised by increasing the observation time.

d) Copper lead frame construction minimizes any thermocouple effects which would degrade low level/high gain data conversion application accuracy (see discussion under "The Benefits of the LMC2001" section above).

e) Rail-to-Rail output swing maximized the ADC dynamic range in 5V single supply converter applications. Below are some typical block diagrams showing the LMC2001 used as an ADC amplifier (Figure 7 and Figure 8).

Application Notes (Continued)

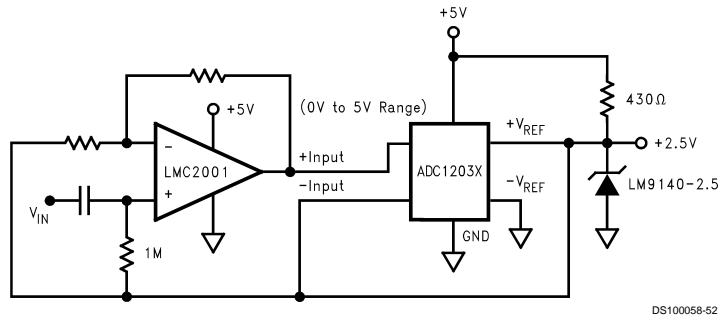

FIGURE 7.

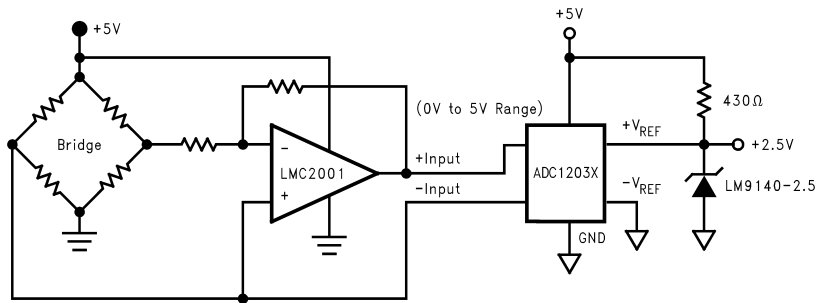
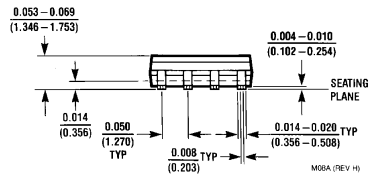
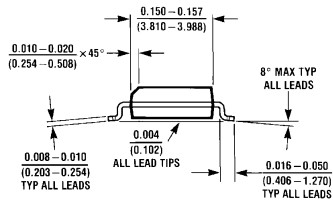
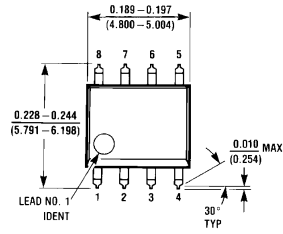

FIGURE 8.

Physical Dimensions inches (millimeters) unless otherwise noted



M08A

M08A (REV H)

Physical Dimensions inches (millimeters) unless otherwise noted (Continued)

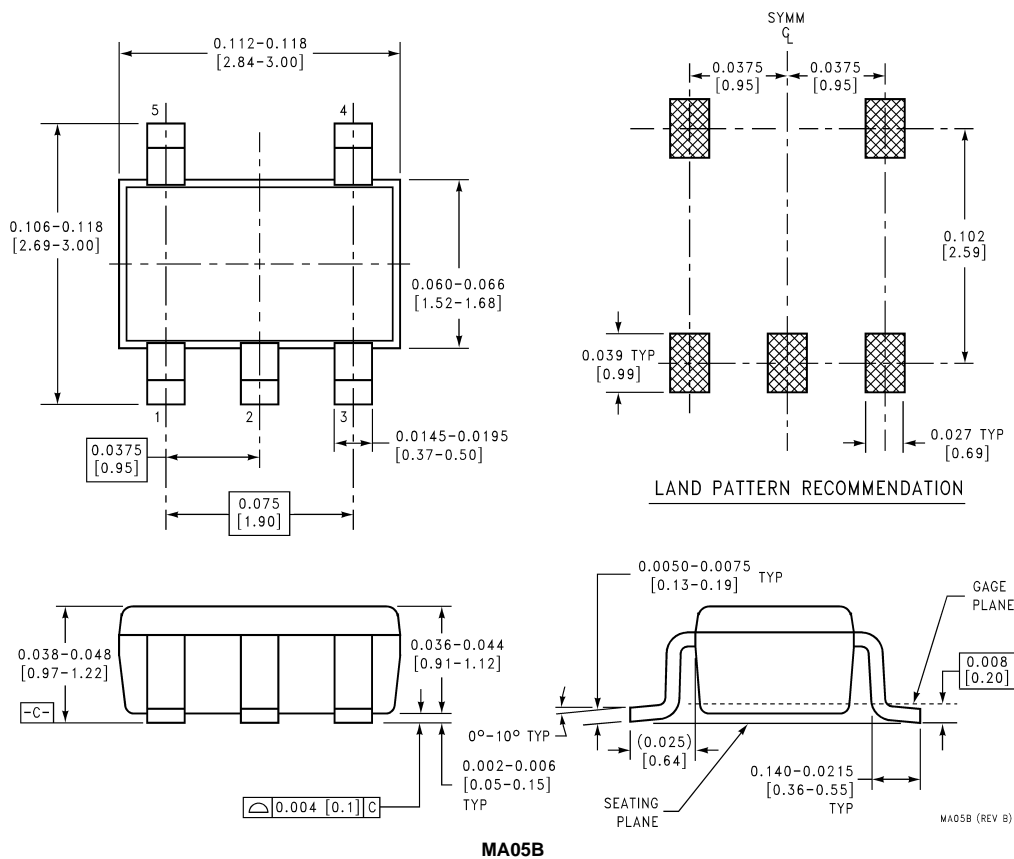

LIFE SUPPORT POLICY

NATIONAL'S PRODUCTS ARE NOT AUTHORIZED FOR USE AS CRITICAL COMPONENTS IN LIFE SUPPORT DEVICES OR SYSTEMS WITHOUT THE EXPRESS WRITTEN APPROVAL OF THE PRESIDENT AND GENERAL COUNSEL OF NATIONAL SEMICONDUCTOR CORPORATION. As used herein:

1. Life support devices or systems are devices or systems which, (a) are intended for surgical implant into the body, or (b) support or sustain life, and whose failure to perform when properly used in accordance with instructions for use provided in the labeling, can be reasonably expected to result in a significant injury to the user.
2. A critical component is any component of a life support device or system whose failure to perform can be reasonably expected to cause the failure of the life support device or system, or to affect its safety or effectiveness.

National Semiconductor Corporation
 Americas
 Tel: 1-800-272-9959
 Fax: 1-800-737-7018
 Email: support@nsc.com
 www.national.com

National Semiconductor Europe
 Fax: +49 (0) 1 80-530 85 86
 Email: europe.support@nsc.com
 Deutsch Tel: +49 (0) 1 80-530 85 85
 English Tel: +49 (0) 1 80-532 78 32
 Français Tel: +49 (0) 1 80-532 93 58
 Italiano Tel: +49 (0) 1 80-534 16 80

National Semiconductor Asia Pacific Customer Response Group
 Tel: 65-2544466
 Fax: 65-2504466
 Email: sea.support@nsc.com

National Semiconductor Japan Ltd.
 Tel: 81-3-5639-7560
 Fax: 81-3-5639-7507

National does not assume any responsibility for use of any circuitry described, no circuit patent licenses are implied and National reserves the right at any time without notice to change said circuitry and specifications.