

**OBSOLETE PRODUCT  
NO RECOMMENDED REPLACEMENT**  
contact our Technical Support Center at  
1-888-INTERSIL or www.intersil.com/tsc

September 26, 2001

FN7151

## 2GHz GBWP Gain-of-10 Stable Operational Amplifier

**élanotec**

The EL2075 is a precision voltage-feedback amplifier featuring a 2GHz gain-bandwidth product, fast settling time, excellent differential gain and differential phase performance, and a minimum of 50mA output current drive over temperature.

The EL2075 is gain-of-10 stable with a -3dB bandwidth of 400MHz at  $A_V = +10$ . It has a very low 200 $\mu$ V of input offset voltage, only 2 $\mu$ A of input bias current, and a fully symmetrical differential input. Like all voltage-feedback operational amplifiers, the EL2075 allows the use of reactive or non-linear components in the feedback loop. This combination of speed and versatility makes the EL2075 the ideal choice for all op-amp applications at a gain of 10 or greater requiring high speed and precision, including active filters, integrators, sample-and-holds, and log amps. The low distortion, high output current, and fast settling makes the EL2075 an ideal amplifier for signal-processing and digitizing systems.

## Features

- 2GHz gain-bandwidth product
- Gain-of-10 stable
- Conventional voltage-feedback topology
- Low offset voltage = 200 $\mu$ V
- Low bias current = 2 $\mu$ A
- Low offset current = 0.1 $\mu$ A
- Output current = 50mA over temperature
- Fast settling = 13ns to 0.1%

## Applications

- Active filters/integrators
- High-speed signal processing
- ADC/DAC buffers
- Pulse/RF amplifiers
- Pin diode receivers
- Log amplifiers
- Photo multiplier amplifiers
- High speed sample-and-holds

**EL2075**  
**(8-PIN SO, PDIP)**  
TOP VIEW

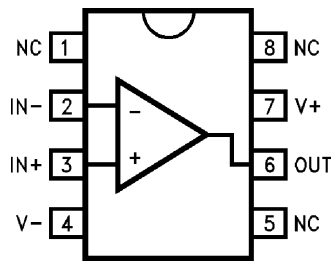

## Ordering Information

PART NUMBER	TEMP. RANGE	PACKAGE	PKG. NO.
EL2075CN	0°C to +75°C	8-Pin PDIP	MDP0031
EL2075CS	0°C to +75°C	8-Pin SO	MDP0027

**Absolute Maximum Ratings** ( $T_A = 25^\circ\text{C}$ )

Supply Voltage ( $V_S$ ) .....  $\pm 7\text{V}$   
 Output Current Output is short-circuit protected to ground, however, maximum reliability is obtained if  $I_{OUT}$  does not exceed 70mA.  
 Common-Mode Input .....  $\pm V_S$   
 Differential Input Voltage .....  $5\text{V}$   
 Note: See EL2071/EL2171 for Thermal Impedance curves.

Thermal Resistance .....  $\theta_{JA} = 95^\circ\text{C/W}$  PDIP  
 .....  $\theta_{JA} = 175^\circ\text{C/W}$  SO-8  
 Operating Temperature .....  $0^\circ\text{C}$  to  $+75^\circ\text{C}$   
 Junction Temperature .....  $175^\circ\text{C}$   
 Storage Temperature .....  $-60^\circ\text{C}$  to  $+150^\circ\text{C}$

CAUTION: Stresses above those listed in "Absolute Maximum Ratings" may cause permanent damage to the device. This is a stress only rating and operation of the device at these or any other conditions above those indicated in the operational sections of this specification is not implied.

IMPORTANT NOTE: All parameters having Min/Max specifications are guaranteed. Typical values are for information purposes only. Unless otherwise noted, all tests are at the specified temperature and are pulsed tests, therefore:  $T_J = T_C = T_A$

**Open-Loop DC Electrical Specifications**  $V_S = \pm 5\text{V}$ ,  $R_L = 100\Omega$ , unless otherwise specified.

PARAMETER	DESCRIPTION	TEST CONDITIONS	TEMP	MIN	TYP	MAX	UNIT
V <sub>OS</sub>	Input Offset Voltage	V <sub>CM</sub> = 0V	25°C		0.2	1	mV
			T <sub>MIN</sub> , T <sub>MAX</sub>			2.5	mV
TCV <sub>OS</sub>	Average Offset Voltage Drift	(Note 1)	All		8		μV/°C
I <sub>B</sub>	Input Bias Current	V <sub>CM</sub> = 0V	All		2	6	μA
I <sub>OS</sub>	Input Offset Current	V <sub>CM</sub> = 0V	25°C		0.1	1	μA
			T <sub>MIN</sub> , T <sub>MAX</sub>			2	μA
PSRR	Power Supply Rejection Ratio	(Note 2)	All	70	90		dB
CMRR	Common Mode Rejection Ratio	(Note 3)	All	70	90		dB
I <sub>S</sub>	Supply Current—Quiescent	No Load	25°C		21	25	mA
			T <sub>MIN</sub> , T <sub>MAX</sub>			25	mA
R <sub>IN</sub> (diff)	R <sub>IN</sub> (Differential)	Open-Loop	25°C		15		kΩ
C <sub>IN</sub> (diff)	C <sub>IN</sub> (Differential)	Open-Loop	25°C		1		pF
R <sub>IN</sub> (cm)	R <sub>IN</sub> (Common-Mode)		25°C		1		MΩ
C <sub>IN</sub> (cm)	C <sub>IN</sub> (Common-Mode)		25°C		1		pF
R <sub>OUT</sub>	Output Resistance		25°C		50		mΩ
CMIR	Common-Mode Input Range		25°C	±3	±3.5		V
			T <sub>MIN</sub> , T <sub>MAX</sub>	±2.5			V
I <sub>OUT</sub>	Output Current		All	50	70		mA
V <sub>OUT</sub>	Output Voltage Swing	No Load	All	±3.5	±4		V
V <sub>OUT</sub> 100	Output Voltage Swing	100Ω	All	±3	±3.6		V
V <sub>OUT</sub> 50	Output Voltage Swing	50Ω	All	±2.5	±3.4		V
A <sub>VOL</sub> 100	Open-Loop Gain	100Ω	25°C	1000	2800		V/V
			T <sub>MIN</sub> , T <sub>MAX</sub>	800			V/V
A <sub>VOL</sub> 50	Open-Loop Gain	50Ω	25°C	800	2300		V/V
			T <sub>MIN</sub> , T <sub>MAX</sub>	600			V/V
e <sub>N</sub> @ > 1MHz	Noise Voltage 1–100MHz		25°C		2.3		nV/√Hz
i <sub>N</sub> @ > 100kHz	Noise Current 100k–100MHz		25°C		3.2		pA/√Hz

NOTES:

1. Measured from T<sub>MIN</sub>, T<sub>MAX</sub>.
2. ±V<sub>CC</sub> = ±4.5V to 5.5V.
3. ±V<sub>IN</sub> = ±2.5V, V<sub>OUT</sub> = 0V.

**Closed-Loop AC Electrical Specifications**  $V_S = \pm 5V$ ,  $A_V = +20$ ,  $R_F = 1500\Omega$ ,  $R_L = 100\Omega$  unless otherwise specified.

PARAMETER	DESCRIPTION	TEST CONDITIONS	TEMP	MIN	TYP	MAX	UNIT
SSBW	-3dB Bandwidth ( $V_{OUT} = 0.4V_{PP}$ )	$A_V = +10$	25°C		400		MHz
		$A_V = +20$	25°C	150	200		MHz
			$T_{MIN}, T_{MAX}$	125			MHz
		$A_V = +50$	25°C		40		MHz
GBWP	Gain-Bandwidth Product	$A_V = +100$	25°C		2.0		GHz
LSBWa	-3dB Bandwidth	$V_{OUT} = 2V_{PP}$ (Note 1)	All	80	128		MHz
LSBWb	-3dB Bandwidth	$V_{OUT} = 5V_{PP}$ (Note 1)	All	32	50		MHz
GFPL	Peaking (< 50MHz)	$V_{OUT} = 0.4V_{PP}$	25°C		0	0.5	dB
			$T_{MIN}, T_{MAX}$			0.5	dB
GFPH	Peaking (> 50MHz)	$V_{OUT} = 0.4V_{PP}$	25°C		0	1	dB
			$T_{MIN}, T_{MAX}$			1	dB
GFR	Rolloff (< 100MHz)	$V_{OUT} = 0.4V_{PP}$	25°C		0.1	0.5	dB
			$T_{MIN}, T_{MAX}$			0.5	dB
LPD	Linear Phase Deviation (< 100MHz)	$V_{OUT} = 0.4V_{PP}$	All		1	1.8	°
PM	Phase Margin	$A_V = +10$	25°C		60		°
$t_{R1}, t_{F1}$	Rise Time, Fall Time	0.4V Step, $A_V = +10$	25°C		1.2		ns
$t_{R2}, t_{F2}$	Rise Time, Fall Time	5V Step, $A_V = +10$	25°C		6		ns
$t_{S1}$	Settling to 0.1% ( $A_V = -20$ )	2V Step	25°C		13		ns
$t_{S2}$	Settling to 0.01% ( $A_V = -20$ )	2V Step	25°C		25		ns
OS	Overshoot	2V Step, $A_V = +10$	25°C		10		%
SR	Slew Rate	2V Step, $A_V = +10$	All	500	800		V/ $\mu$ s
<b>DISTORTION</b> (Note 2)							
HD2	2nd Harmonic Distortion	@ 20MHz, $A_V = +20$	25°C		-40	-30	dBc
			$T_{MIN}, T_{MAX}$			-30	dBc
HD3	3rd Harmonic Distortion	@ 20MHz, $A_V = +20$	25°C		-65	-50	dBc
			$T_{MIN}, T_{MAX}$			-50	dBc

NOTES:

1. Large-signal bandwidth calculated using  $LSBW = \text{Slew Rate} (2\pi * V_{PEAK})$ .
2. All distortion measurements are made with  $V_{OUT} = 2V_{PP}$ ,  $R_L = 100\Omega$ .

Typical Performance Curves

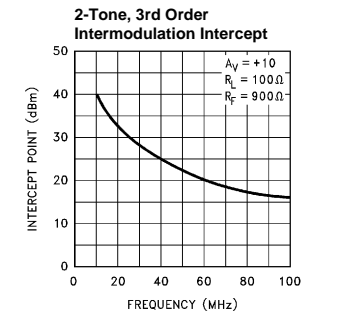
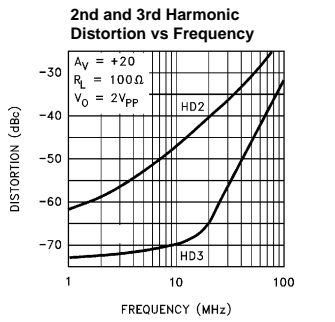
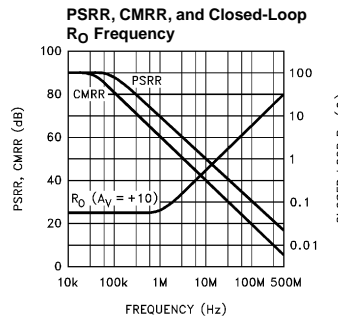
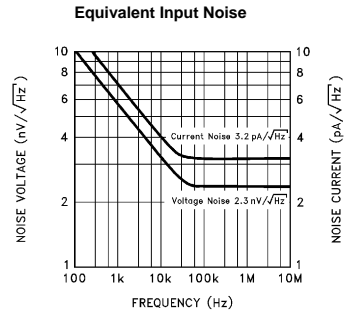
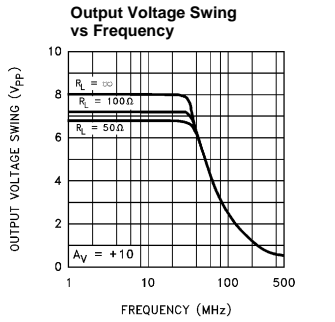
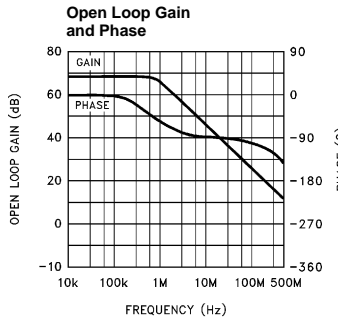
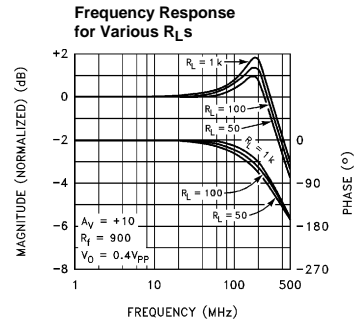
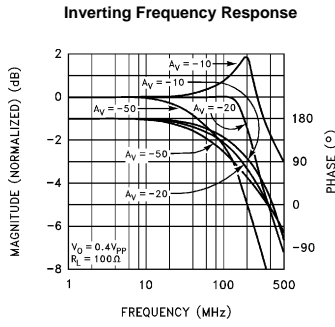
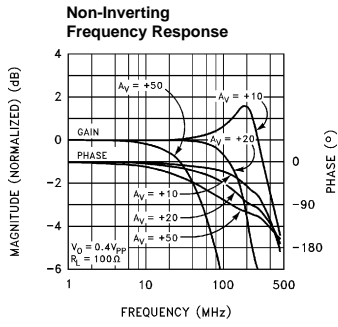

Typical Performance Curves (Continued)

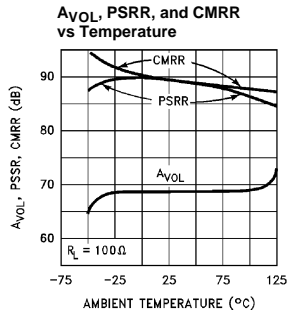
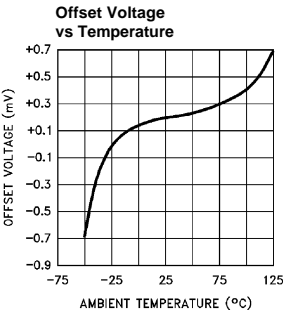
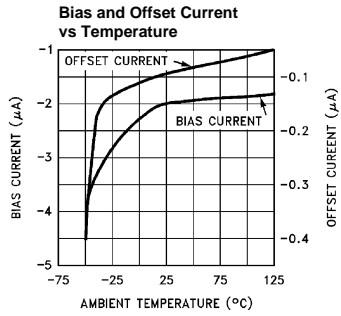
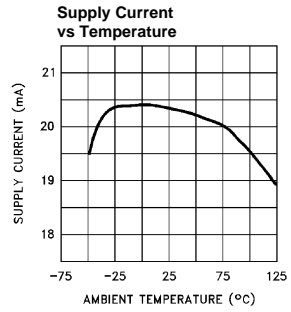
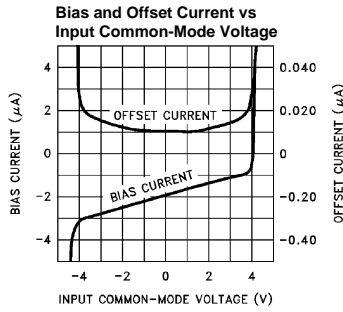
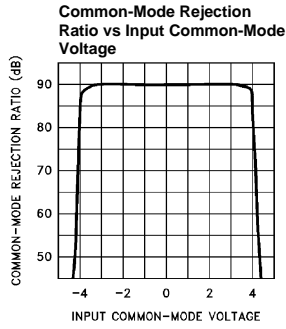
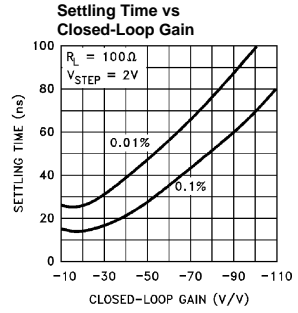
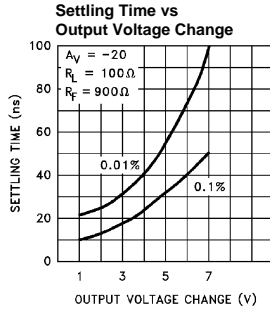
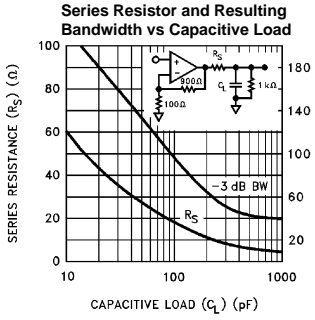

Small Signal Transient Response

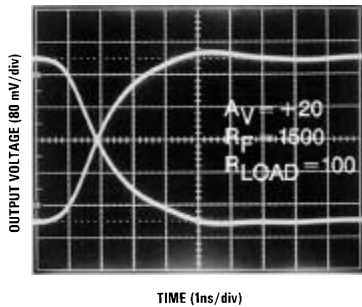

Large Signal Transient Response

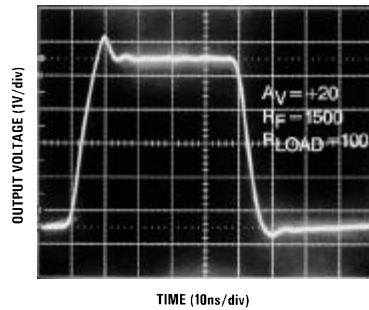

## Equivalent Circuit

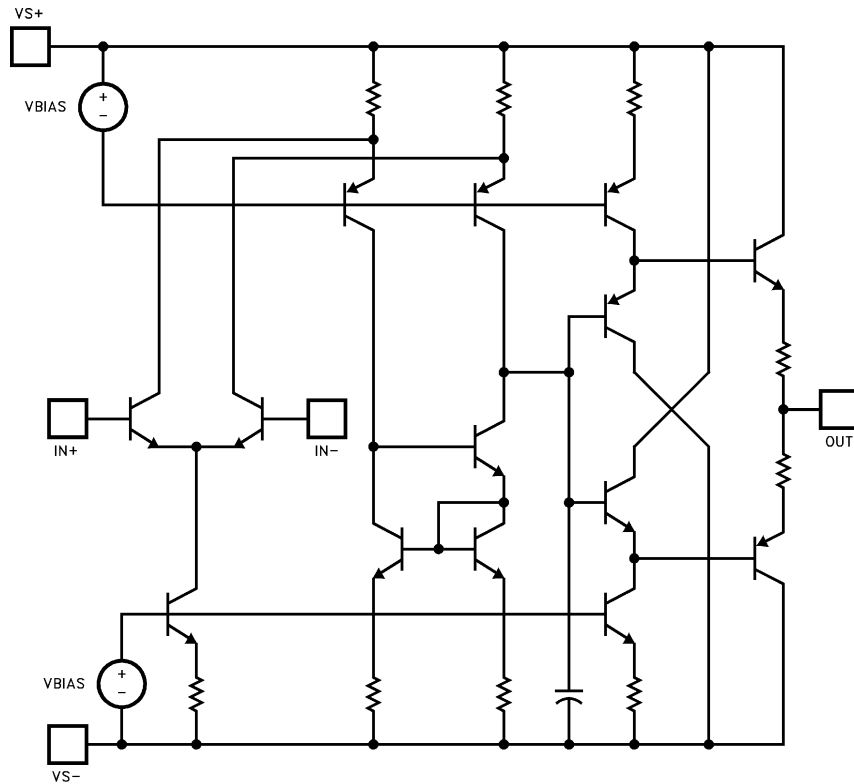

## Burn-In Circuit

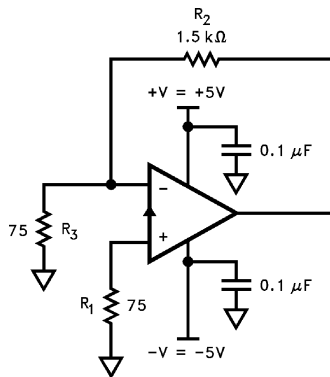

All Packages Use The Same Schematic

## Applications Information

### Product Description

The EL2075 is a wideband monolithic operational amplifier built on a high-speed complementary bipolar process. The EL2075 uses a classical voltage-feedback topology which allows it to be used in a variety of applications requiring a noise gain  $\geq 10$  where current-feedback amplifiers are not appropriate because of restrictions placed upon the feedback element used with the amplifier. The conventional topology of the EL2075 allows, for example, a capacitor to be placed in the feedback path, making it an excellent choice

for applications such as active filters, sample-and-holds, or integrators. Similarly, because of the ability to use diodes in the feedback network, the EL2075 is an excellent choice for applications such as log amplifiers.

The EL2075 also has excellent DC specifications:  $200\mu\text{V}$ ,  $V_{OS}$ ,  $2\mu\text{A}$   $I_B$ ,  $0.1\mu\text{A}$   $I_{OS}$ , and 90dB of CMRR. These specifications allow the EL2075 to be used in DC-sensitive applications such as difference amplifiers. Furthermore, the current noise of the EL2075 is only  $3.2\text{pA}/\sqrt{\text{Hz}}$ , making it an excellent choice for high-sensitivity transimpedance amplifier configurations.

### Gain-Bandwidth Product

The EL2075 has a gain-bandwidth product of 2GHz. For gains greater than 40, its closed-loop -3dB bandwidth is approximately equal to the gain-bandwidth product divided by the noise gain of the circuit. For gains less than 40, higher-order poles in the amplifier's transfer function contribute to even higher closed loop bandwidths. For example, the EL2075 has a -3dB bandwidth of 400MHz at a gain of +10, dropping to 200MHz at a gain of +20. It is important to note that the EL2075 has been designed so that this "extra" bandwidth in low-gain applications does not come at the expense of stability. As seen in the typical performance curves, the EL2075 in a gain of +10 only exhibits 1.5dB of peaking with a  $100\Omega$  load.

### **Output Drive Capability**

The EL2075 has been optimized to drive 50Ω and 75Ω loads. It can easily drive 6V<sub>PP</sub> into a 50Ω load. This high output drive capability makes the EL2075 an ideal choice for RF and IF applications. Furthermore, the current drive of the EL2075 remains a minimum of 50mA at low temperatures. The EL2075 is current-limited at the output, allowing it to withstand momentary shorts to ground. However, power dissipation with the output shorted can be in excess of the power-dissipation capabilities of the package.

### **Capacitive Loads**

Although the EL2075 has been optimized to drive resistive loads as low as 50Ω, capacitive loads will decrease the amplifier's phase margin which may result in peaking, overshoot, and possible oscillation. For optimum AC performance, capacitive loads should be reduced as much as possible or isolated via a series output resistor. Coax lines can be driven, as long as they are terminated with their characteristic impedance. When properly terminated, the capacitance of coaxial cable will not add to the capacitive load seen by the amplifier. Capacitive loads greater than 10pF should be buffered with a series resistor (R<sub>S</sub>) to isolate the load capacitance from the amplifier output. A curve of recommended R<sub>S</sub> vs C<sub>LOAD</sub> has been included for

reference. Values of R<sub>S</sub> were chosen to maximize resulting bandwidth without additional peaking.

### **Printed-Circuit Layout**

As with any high-frequency device, good PCB layout is necessary for optimum performance. Ground-plane construction is highly recommended, as is good power supply bypassing. A 1μF–10μF tantalum capacitor is recommended in parallel with a 0.01μF ceramic capacitor. All pin lengths should be as short as possible, and all bypass capacitors should be as close to the device pins as possible. Parasitic capacitances should be kept to an absolute minimum at both inputs and at the output. Resistor values should be kept under 1000Ω to 2000Ω because of the RC time constants associated with the parasitic capacitance. Metal-film and carbon resistors are both acceptable, use of wire-wound resistors is not recommended because of parasitic inductance. Similarly, capacitors should be low-inductance for best performance. If possible, solder the EL2075 directly to the PC board without a socket. Even high quality sockets add parasitic capacitance and inductance which can potentially degrade performance. Because of the degradation of AC performance due to parasitics, the use of surface-mount components (resistors, capacitors, etc.) is also recommended.

All Intersil U.S. products are manufactured, assembled and tested utilizing ISO9000 quality systems.  
Intersil Corporation's quality certifications can be viewed at [www.intersil.com/design/quality](http://www.intersil.com/design/quality)

---

*Intersil products are sold by description only. Intersil Corporation reserves the right to make changes in circuit design, software and/or specifications at any time without notice. Accordingly, the reader is cautioned to verify that data sheets are current before placing orders. Information furnished by Intersil is believed to be accurate and reliable. However, no responsibility is assumed by Intersil or its subsidiaries for its use; nor for any infringements of patents or other rights of third parties which may result from its use. No license is granted by implication or otherwise under any patent or patent rights of Intersil or its subsidiaries.*

---

For information regarding Intersil Corporation and its products, see [www.intersil.com](http://www.intersil.com)

**EL2075 Macromodel**

```

*
* Connections:  input
*              |   -input
*              |   |   +Vsupply
*              |   |   -Vsupply
*              |   |   output
*              |   |   |
.subckt M2075C 3 2 7 4 6

```

## \*Input Stage

```

*
ie 37 4 1mA
r6 36 37 15
r7 38 37 15
rc1 7 30 200
rc2 7 39 200
q1 30 3 36 qn
q2 39 2 38 qna
ediff 33 0 39 30 1
rdiff 33 0 1 Meg

```

## \* Compensation Section

```

*
ga 0 34 33 0 2m
rh 34 0 500K
ch 34 0 0.4 pF
rc 34 40 50
cc 40 0 0.05 pF

```

## \* Poles

```

*
ep 41 0 40 0 1
rpa 41 42 250
cpa 42 0 0.8 pF
rpb 42 43 50
cpb 43 0 0.5 pF

```

## \* Output Stage

```

*
ios1 7 50 3.0mA
ios2 51 4 3.0mA
q3 4 43 50 qp
q4 7 43 51 qn
q5 7 50 52 qn
q6 4 51 53 qp
ros1 52 6 2
ros2 6 53 2

```

## \* Power Supply Current

```

*
ips 7 4 11.4mA

```

## \* Models

```

*
.model qna npn(is800e-18 bf170 tf0.2ns)
.model qn npn(is810e-18 bf200 tf0.2ns)
.model qp pnp(is800e-18 bf200 tf0.2ns)
.ends

```