



# TSV6290, TSV6290A, TSV6291, TSV6291A

## Micropower with high merit factor CMOS operational amplifiers

### Features

- Low supply voltage: 1.5 V – 5.5 V
- Rail-to-rail input and output
- Low input offset voltage: 800  $\mu$ V max (A version)
- Low power consumption: 29  $\mu$ A typical
- Gain bandwidth product: 1.3 MHz typical
- Stable when used in gain configuration
- Micropackages: SC70-5/6, SOT23-5/6
- Low input bias current: 1 pA typical
- Extended temperature range: -40 to +125°C
- 4 kV human body model

### Applications

- Battery-powered applications
- Portable devices
- Signal conditioning
- Active filtering
- Medical instrumentation

### Description

The TSV6290 and the TSV6291 are single operational amplifiers with a high bandwidth while consuming only 29  $\mu$ A. They must be used in a gain configuration ( $G < -3$ ,  $G > +4$ ).

With a very low input bias current and low offset voltage (800  $\mu$ V maximum for the A version), the TSV629x family of devices is ideal for applications requiring precision. The devices can operate at a power supply ranging from 1.5 to 5.5 V, and therefore suit battery-powered devices, extending battery life.

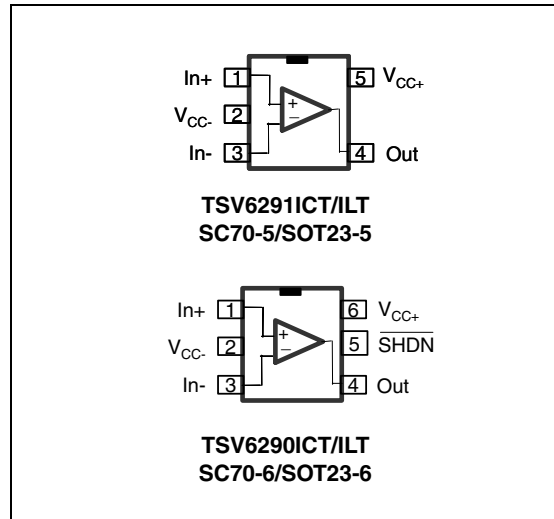

The TSV6290 comes with a shutdown function.

The TSV6290 and TSV6291 present a high tolerance to ESD, sustaining 4 kV for the human body model.

Additionally, the TSV6290 and TSV6291 are offered in SC70-5/6 and SOT23-5/6 micropackages, with extended temperature ranges from -40° C to +125° C.

All these features make the TSV629x ideal for sensor interfaces, battery-supplied and portable applications, as well as active filtering.

# Contents

<b>1</b>	<b>Absolute maximum ratings and operating conditions</b>	<b>3</b>
<b>2</b>	<b>Electrical characteristics</b>	<b>4</b>
<b>3</b>	<b>Application information</b>	<b>12</b>
3.1	Operating voltages	12
3.2	Rail-to-rail input	12
3.3	Rail-to-rail output	12
3.4	Shutdown function (TSV6290)	12
3.5	Optimization of DC and AC parameters	14
3.6	Driving resistive and capacitive loads	14
3.7	PCB layouts	14
3.8	Macromodel	14
<b>4</b>	<b>Package information</b>	<b>15</b>
4.1	SOT23-5 package mechanical data	16
4.2	SOT23-6 package mechanical data	17
4.3	SC70-5 (or SOT323-5) package mechanical data	18
4.4	SC70-6 (or SOT323-6) package mechanical data	19
<b>5</b>	<b>Ordering information</b>	<b>21</b>
<b>6</b>	<b>Revision history</b>	<b>22</b>

# 1 Absolute maximum ratings and operating conditions

**Table 1. Absolute maximum ratings (AMR)**

Symbol	Parameter	Value	Unit
$V_{CC}$	Supply voltage <sup>(1)</sup>	6	V
$V_{id}$	Differential input voltage <sup>(2)</sup>	$\pm V_{CC}$	V
$V_{in}$	Input voltage <sup>(3)</sup>	$V_{CC} - 0.2$ to $V_{CC} + 0.2$	V
$I_{in}$	Input current <sup>(4)</sup>	10	mA
$\overline{SHDN}$	Shutdown voltage <sup>(3)</sup>	$V_{CC} - 0.2$ to $V_{CC} + 0.2$	V
$T_{stg}$	Storage temperature	-65 to +150	°C
$R_{thja}$	Thermal resistance junction to ambient <sup>(5)(6)</sup>		°C/W
	SC70-5	205	
	SOT23-5	250	
	SOT23-6	240	
	SC70-6	232	
$T_j$	Maximum junction temperature	150	°C
ESD	HBM: human body model <sup>(7)</sup>	4	kV
	MM: machine model <sup>(8)</sup>	300	V
	CDM: charged device model <sup>(9)</sup>	1.5	kV
	Latch-up immunity	200	mA

- All voltage values, except differential voltage, are with respect to network ground terminal.
- Differential voltages are the non-inverting input terminal with respect to the inverting input terminal.
- $V_{CC} - V_{in}$  must not exceed 6 V,  $V_{in}$  must not exceed 6 V.
- Input current must be limited by a resistor in series with the inputs.
- Short-circuits can cause excessive heating and destructive dissipation.
- $R_{th}$  are typical values.
- Human body model: 100 pF discharged through a 1.5 k $\Omega$  resistor between two pins of the device, done for all couples of pin combinations with other pins floating.
- Machine mode: a 200 pF capacitor is charged to the specified voltage, then discharged directly between two pins of the device with no external series resistor (internal resistor < 5  $\Omega$ ), done for all couples of pin combinations with other pins floating.
- Charged device model: all pins plus package are charged together to the specified voltage and then discharged directly to the ground.

**Table 2. Operating conditions**

Symbol	Parameter	Value	Unit
$V_{CC}$	Supply voltage	1.5 to 5.5	V
$V_{icm}$	Common mode input voltage range	$V_{CC} - 0.1$ to $V_{CC} + 0.1$	V
$T_{oper}$	Operating free air temperature range	-40 to +125	°C

## 2 Electrical characteristics

**Table 3. Electrical characteristics at  $V_{CC+} = +1.8\text{ V}$  with  $V_{CC-} = 0\text{ V}$ ,  $V_{icm} = V_{CC}/2$ ,  $T_{amb} = 25^\circ\text{ C}$ , and  $R_L$  connected to  $V_{CC}/2$  (unless otherwise specified)**

Symbol	Parameter	Conditions	Min.	Typ.	Max.	Unit
<b>DC performance</b>						
$V_{io}$	Offset voltage	TSV6290-TSV6291 TSV6290A-TSV6291A			4 0.8	mV
		$T_{min} < T_{op} < T_{max}$ TSV6290-TSV6291 TSV6290A-TSV6291A			6 2	
$DV_{io}$	Input offset voltage drift			2		$\mu\text{V}/^\circ\text{C}$
$I_{io}$	Input offset current <sup>(1)</sup> ( $V_{out} = V_{CC}/2$ )			1	10	pA
		$T_{min} < T_{op} < T_{max}$		1	100	
$I_{ib}$	Input bias current <sup>(1)</sup> ( $V_{out} = V_{CC}/2$ )			1	10	pA
		$T_{min} < T_{op} < T_{max}$		1	100	
CMR	Common mode rejection ratio $20 \log (\Delta V_{ic}/\Delta V_{io})$	$0\text{ V to }1.8\text{ V}$ , $V_{out} = 0.9\text{ V}$	53	74		dB
		$T_{min} < T_{op} < T_{max}$	51			
$A_{vd}$	Large signal voltage gain	$R_L = 10\text{ k}\Omega$ , $V_{out} = 0.5\text{ V to }1.3\text{ V}$	78	95		dB
		$T_{min} < T_{op} < T_{max}$	73			
$V_{OH}$	High level output voltage	$R_L = 10\text{ k}\Omega$	35	5		mV
		$T_{min} < T_{op} < T_{max}$	50			
$V_{OL}$	Low level output voltage	$R_L = 10\text{ k}\Omega$		4	35	mV
		$T_{min} < T_{op} < T_{max}$			50	
$I_{out}$	Isink	$V_{out} = 1.8\text{ V}$	6	12		mA
		$T_{min} < T_{op} < T_{max}$	4			
	Isource	$V_{out} = 0\text{ V}$	6	10		mA
		$T_{min} < T_{op} < T_{max}$	4			
$I_{CC}$	Supply current (per operator)	No load, $V_{out} = V_{CC}/2$		25	31	$\mu\text{A}$
		$T_{min} < T_{op} < T_{max}$			33	
<b>AC performance</b>						
GBP	Gain bandwidth product	$R_L = 10\text{ k}\Omega$ , $C_L = 100\text{ pF}$		1.1		MHz
Gain	Minimum gain for stability	Phase margin = $60^\circ$ , $R_f = 10\text{ k}\Omega$ , $R_L = 10\text{ k}\Omega$ , $C_L = 20\text{ pF}$		+4 -3		V/V
SR	Slew rate	$R_L = 10\text{ k}\Omega$ , $C_L = 100\text{ pF}$ , $V_{out} = 0.5\text{ V to }1.3\text{ V}$		0.33		V/ $\mu\text{s}$

1. Guaranteed by design.

Table 4. Shutdown characteristics  $V_{CC} = 1.8\text{ V}$  (TSV6290)

Symbol	Parameter	Conditions	Min.	Typ.	Max.	Unit
<b>DC performance</b>						
$I_{CC}$	Supply current in shutdown mode (all operators)	$\overline{\text{SHDN}} = V_{CC-}$		2.5	50	nA
		$T_{\min} < T_{op} < 85^\circ\text{ C}$			200	nA
		$T_{\min} < T_{op} < 125^\circ\text{ C}$			1.5	$\mu\text{A}$
$t_{on}$	Amplifier turn-on time	$R_L = 5\text{ k}\Omega$ , $V_{out} = V_{CC-}$ to $V_{CC+} + 0.2\text{ V}$		300		ns
$t_{off}$	Amplifier turn-off time	$R_L = 5\text{ k}\Omega$ , $V_{out} = V_{CC+} - 0.5$ to $V_{CC+} - 0.7\text{ V}$		30		ns
$V_{IH}$	$\overline{\text{SHDN}}$ logic high		1.3			V
$V_{IL}$	$\overline{\text{SHDN}}$ logic low				0.5	V
$I_{IH}$	$\overline{\text{SHDN}}$ current high	$\overline{\text{SHDN}} = V_{CC+}$		10		$\mu\text{A}$
$I_{IL}$	$\overline{\text{SHDN}}$ current low	$\overline{\text{SHDN}} = V_{CC-}$		10		$\mu\text{A}$
$I_{OLeak}$	Output leakage in shutdown mode	$\overline{\text{SHDN}} = V_{CC-}$		50		$\mu\text{A}$
		$T_{\min} < T_{op} < T_{\max}$		1		nA

**Table 5.**  $V_{CC+} = +3.3\text{ V}$ ,  $V_{CC-} = 0\text{ V}$ ,  $V_{icm} = V_{CC}/2$ ,  $T_{amb} = 25^\circ\text{ C}$ ,  $R_L$  connected to  $V_{CC}/2$   
(unless otherwise specified)

Symbol	Parameter		Min.	Typ.	Max.	Unit
<b>DC performance</b>						
$V_{io}$	Offset voltage	TSV6290-TSV6291 TSV6290A-TSV6291A			4 0.8	mV
		$T_{min} < T_{op} < T_{max}$ TSV6290-TSV6291 TSV6290A-TSV6291A			6 2	
$DV_{io}$	Input offset voltage drift			2		$\mu\text{V}/^\circ\text{C}$
$I_{io}$	Input offset current <sup>(1)</sup>			1	10	pA
		$T_{min} < T_{op} < T_{max}$		1	100	pA
$I_{ib}$	Input bias current <sup>(1)</sup>			1	10	pA
		$T_{min} < T_{op} < T_{max}$		1	100	pA
CMR	Common mode rejection ratio $20 \log (\Delta V_{ic}/\Delta V_{io})$	0 V to 3.3 V, $V_{out} = 1.65\text{ V}$	57	79		dB
		$T_{min} < T_{op} < T_{max}$	53			dB
$A_{vd}$	Large signal voltage gain	$R_L = 10\text{ k}\Omega$ , $V_{out} = 0.5\text{ V to } 2.8\text{ V}$	81	98		dB
		$T_{min} < T_{op} < T_{max}$	76			dB
$V_{OH}$	High level output voltage	$R_L = 10\text{ k}\Omega$	35	5		mV
		$T_{min} < T_{op} < T_{max}$	50			
$V_{OL}$	Low level output voltage	$R_L = 10\text{ k}\Omega$		4	35	mV
		$T_{min} < T_{op} < T_{max}$			50	
$I_{out}$	Isink	$V_{out} = 5\text{ V}$	23	45		mA
		$T_{min} < T_{op} < T_{max}$	20			
	Isource	$V_{out} = 0\text{ V}$	23	38		mA
		$T_{min} < T_{op} < T_{max}$	20			
$I_{CC}$	Supply current (per operator)	No load, $V_{out} = 2.5\text{ V}$		26	33	$\mu\text{A}$
		$T_{min} < T_{op} < T_{max}$			35	$\mu\text{A}$
<b>AC performance</b>						
GBP	Gain bandwidth product	$R_L = 10\text{ k}\Omega$ , $C_L = 100\text{ pF}$		1.2		MHz
Gain	Minimum gain for stability	Phase margin = $60^\circ$ , $R_f = 10\text{ k}\Omega$ , $R_L = 10\text{ k}\Omega$ , $C_L = 20\text{ pF}$		+4 -3		V/V
SR	Slew rate	$R_L = 10\text{ k}\Omega$ , $C_L = 100\text{ pF}$ , $V_{out} = 0.5\text{ V to } 2.8\text{ V}$		0.4		V/ $\mu\text{s}$

1. Guaranteed by design.

**Table 6.**  $V_{CC+} = +5\text{ V}$ ,  $V_{CC-} = 0\text{ V}$ ,  $V_{icm} = V_{CC}/2$ ,  $T_{amb} = 25^\circ\text{ C}$ ,  $R_L$  connected to  $V_{CC}/2$   
(unless otherwise specified)

Symbol	Parameter		Min.	Typ.	Max.	Unit
<b>DC performance</b>						
$V_{io}$	Offset voltage	TSV6290-TSV6291 TSV6290A-TSV6291A			4 0.8	mV
		$T_{min} < T_{op} < T_{max}$ TSV6290-TSV6291 TSV6290A-TSV6291A			6 2	
$DV_{io}$	Input offset voltage drift			2		$\mu\text{V}/^\circ\text{C}$
$I_{io}$	Input offset current <sup>(1)</sup>			1	10	pA
		$T_{min} < T_{op} < T_{max}$		1	100	pA
$I_{ib}$	Input bias current <sup>(1)</sup>			1	10	pA
		$T_{min} < T_{op} < T_{max}$		1	100	pA
CMR	Common mode rejection ratio $20 \log(\Delta V_{ic}/\Delta V_{io})$	0 V to 5 V, $V_{out} = 2.5\text{ V}$	60	80		dB
		$T_{min} < T_{op} < T_{max}$	55			
SVR	Supply voltage rejection ratio $20 \log(\Delta V_{CC}/\Delta V_{io})$	$V_{CC} = 1.8\text{ to }5\text{ V}$	75	102		dB
		$T_{min} < T_{op} < T_{max}$	73			
$A_{vd}$	Large signal voltage gain	$R_L = 10\text{ k}\Omega$ , $V_{out} = 0.5\text{ V to }4.5\text{ V}$	85	98		dB
		$T_{min} < T_{op} < T_{max}$	80			
$V_{OH}$	High level output voltage	$R_L = 10\text{ k}\Omega$	35	7		mV
		$T_{min} < T_{op} < T_{max}$	50			
$V_{OL}$	Low level output voltage	$R_L = 10\text{ k}\Omega$		6	35	mV
		$T_{min} < T_{op} < T_{max}$			50	
$I_{out}$	$I_{sink}$	$V_{out} = 5\text{ V}$	40	69		mA
		$T_{min} < T_{op} < T_{max}$	35			
	$I_{source}$	$V_{out} = 0\text{ V}$	40	74		mA
		$T_{min} < T_{op} < T_{max}$	35			
$I_{CC}$	Supply current (per operator)	No load, $V_{out} = 2.5\text{ V}$		30	36	$\mu\text{A}$
		$T_{min} < T_{op} < T_{max}$			38	$\mu\text{A}$
<b>AC performance</b>						
GBP	Gain bandwidth product	$R_L = 10\text{ k}\Omega$ , $C_L = 100\text{ pF}$		1.3		MHz
Gain	Minimum gain for stability	Phase margin = $60^\circ$ , $R_f = 10\text{ k}\Omega$ , $R_L = 10\text{ k}\Omega$ , $C_L = 20\text{ pF}$		+4 -3		V/V
SR	Slew rate	$R_L = 10\text{ k}\Omega$ , $C_L = 100\text{ pF}$ , $V_{out} = 0.5\text{ V to }4.5\text{ V}$		0.5		V/ $\mu\text{s}$

**Table 6.**  $V_{CC+} = +5\text{ V}$ ,  $V_{CC-} = 0\text{ V}$ ,  $V_{icm} = V_{CC}/2$ ,  $T_{amb} = 25^\circ\text{ C}$ ,  $R_L$  connected to  $V_{CC}/2$   
(unless otherwise specified) (continued)

Symbol	Parameter		Min.	Typ.	Max.	Unit
$e_n$	Equivalent input noise voltage	$f = 1\text{ kHz}$		70		$\frac{\text{nV}}{\sqrt{\text{Hz}}}$
THD	Total harmonic distortion	$A_v = -10$ , $f_{in} = 1\text{ kHz}$ , $R_L = 100\text{ k}\Omega$ $V_{icm} = V_{CC}/2$ , $V_{in} = 40\text{ mVpp}$		0.15		%

1. Guaranteed by design.

**Table 7.** Shutdown characteristics  $V_{CC} = 5\text{ V}$  (TSV6290)

Symbol	Parameter	Conditions	Min.	Typ.	Max.	Unit
<b>DC performance</b>						
$I_{CC}$	Supply current in shutdown mode (all operators)	$\overline{\text{SHDN}} = V_{IL}$		5	50	nA
		$T_{min} < T_{op} < 85^\circ\text{ C}$			200	nA
		$T_{min} < T_{op} < 125^\circ\text{ C}$			1.5	$\mu\text{A}$
$t_{on}$	Amplifier turn-on time	$R_L = 5\text{ k}\Omega$ , $V_{out} = V_{CC-}$ to $V_{CC+} + 0.2\text{ V}$		300		ns
$t_{off}$	Amplifier turn-off time	$R_L = 5\text{ k}\Omega$ , $V_{out} = V_{CC+} - 0.5\text{ V}$ to $V_{CC+} - 0.7\text{ V}$		30		ns
$V_{IH}$	$\overline{\text{SHDN}}$ logic high		4.5			V
$V_{IL}$	$\overline{\text{SHDN}}$ logic low				0.5	V
$I_{IH}$	$\overline{\text{SHDN}}$ current high	$\overline{\text{SHDN}} = V_{CC+}$		10		$\mu\text{A}$
$I_{IL}$	$\overline{\text{SHDN}}$ current low	$\overline{\text{SHDN}} = V_{CC-}$		10		$\mu\text{A}$
$I_{OLeak}$	Output leakage in shutdown mode	$\overline{\text{SHDN}} = V_{CC-}$		50		$\mu\text{A}$
		$T_{min} < T_{op} < T_{max}$		1		nA



Figure 1. Supply current vs. supply voltage at  $V_{icm} = V_{CC}/2$

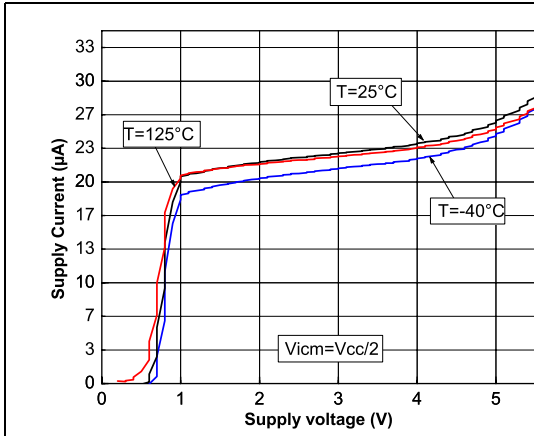

Figure 2. Output current vs. output voltage at  $V_{CC} = 1.5 V$

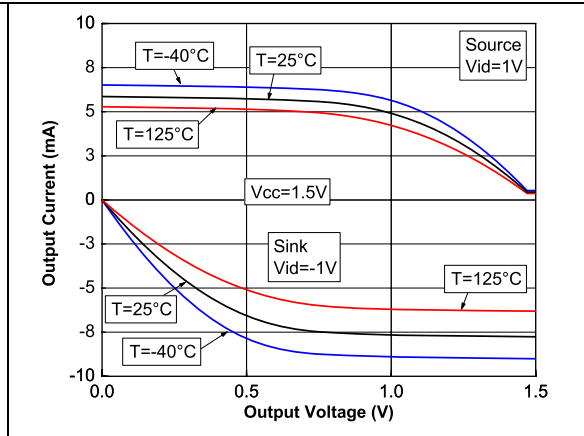

Figure 3. Output current vs. output voltage at  $V_{CC} = 5 V$

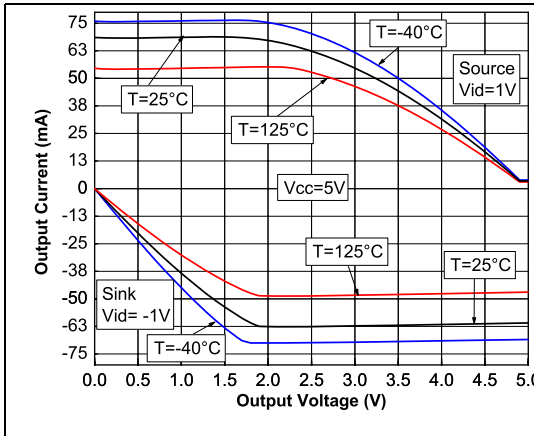

Figure 4. Peaking at closed loop gain = -10 at  $V_{CC} = 1.5 V$  and  $V_{CC} = 5 V$

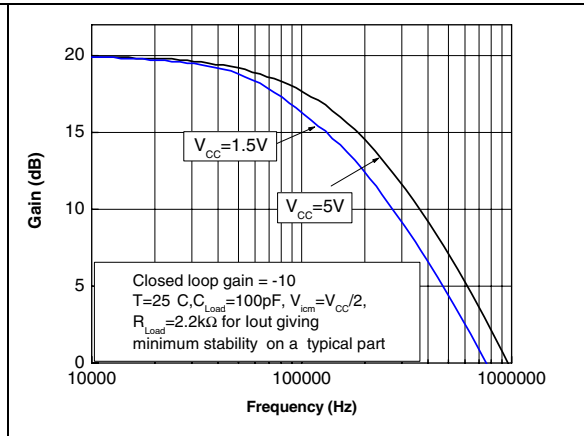

Figure 5. Peaking at closed loop gain = -3,  $V_{CC} = 1.5 V$

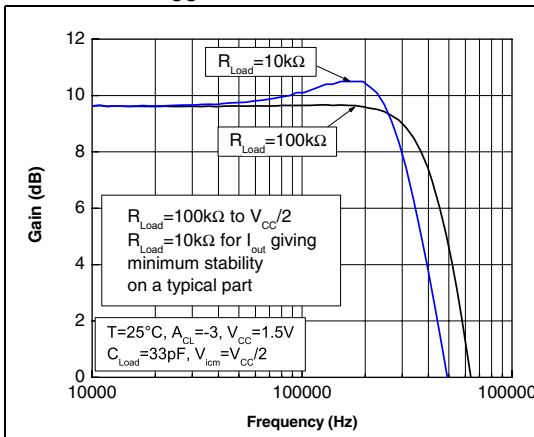

Figure 6. Peaking at closed loop gain = -3,  $V_{CC} = 5 V$

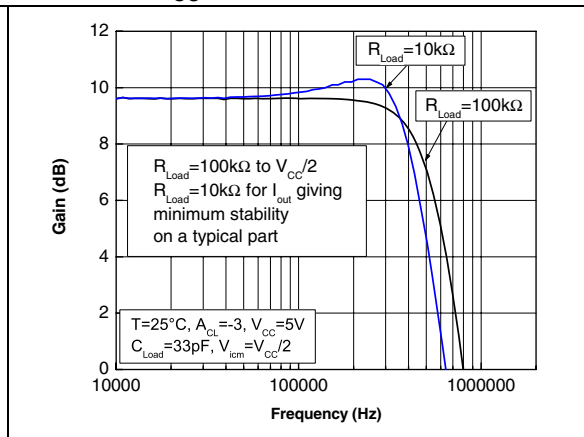

Figure 7. Positive slew rate vs. supply voltage in closed loop

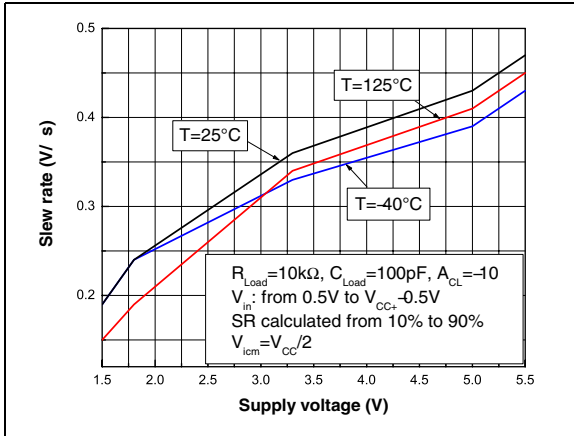

Figure 8. Negative slew rate vs. supply voltage in closed loop

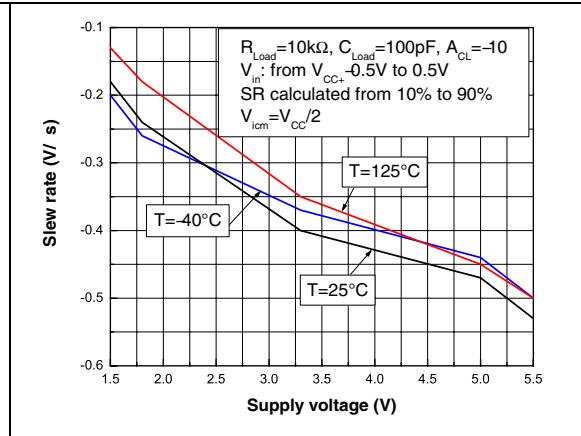

Figure 9. Slew rate vs. supply voltage in open loop

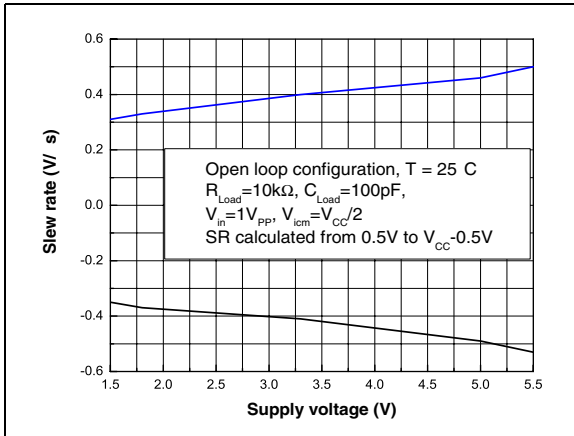

Figure 10. Slew rate timing in open loop

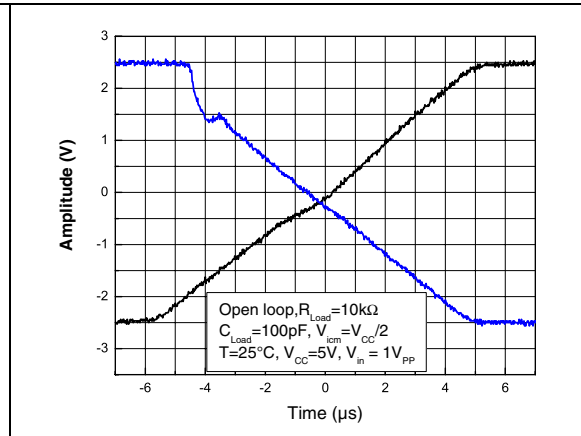

Figure 11. Slew rate timing in closed loop

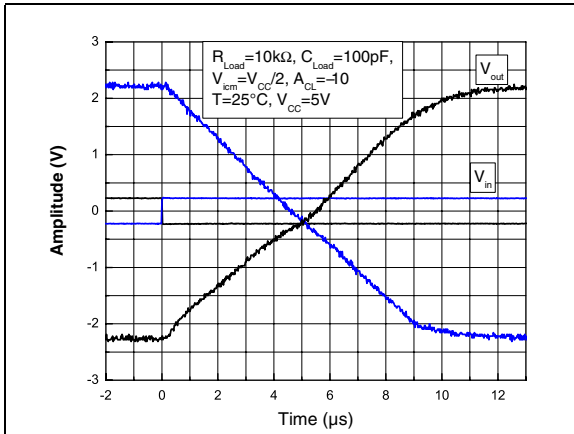

Figure 12. Noise at V<sub>CC</sub> = 5 V

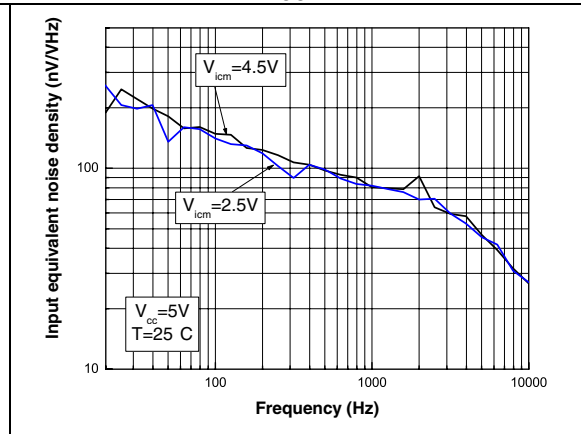

Figure 13. Distortion + noise vs. output voltage at  $V_{CC} = 1.8\text{ V}$

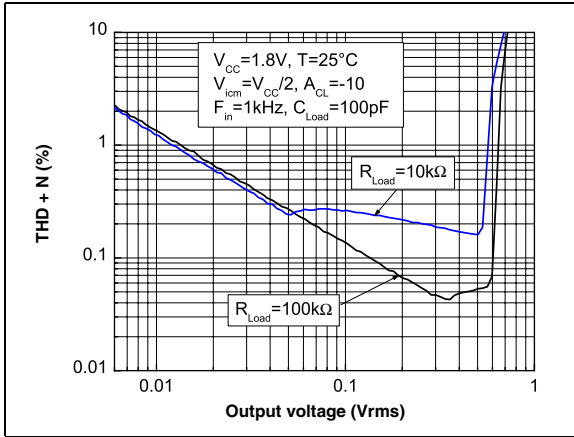

Figure 14. Distortion + noise vs. output voltage at  $V_{CC} = 5\text{ V}$

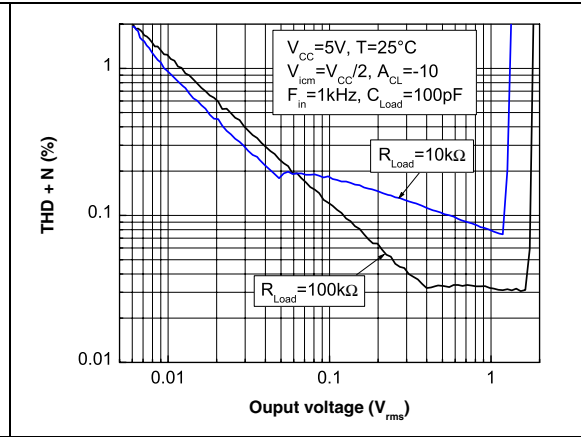

Figure 15. Distortion + noise vs. frequency at  $V_{CC} = 1.8\text{ V}$

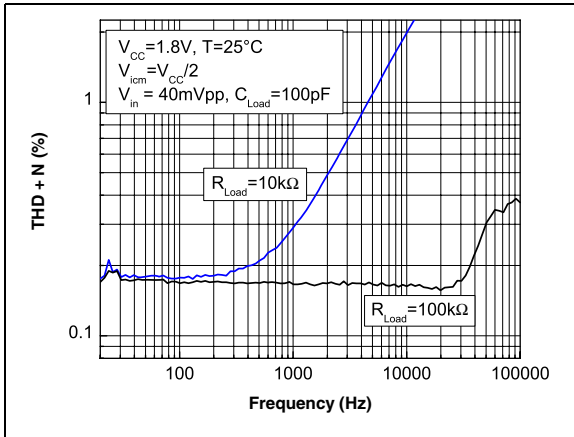
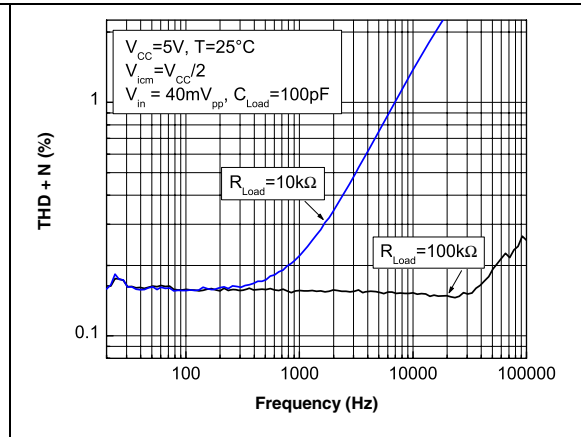

Figure 16. Distortion + noise vs. frequency at  $V_{CC} = 5\text{ V}$



## 3 Application information

### 3.1 Operating voltages

The TSV6290 and TSV6291 can operate from 1.5 to 5.5 V. Their parameters are fully specified for 1.8, 3.3 and 5 V power supplies. However, the parameters are very stable in the full  $V_{CC}$  range and several characterization curves show the TSV629x characteristics at 1.5 V. Additionally, the main specifications are guaranteed in extended temperature ranges from  $-40^{\circ}\text{C}$  to  $+125^{\circ}\text{C}$ .

### 3.2 Rail-to-rail input

The TSV6290 and TSV6291 are built with two complementary PMOS and NMOS input differential pairs. The devices have a rail-to-rail input, and the input common-mode range is extended from  $V_{CC-} - 0.1\text{ V}$  to  $V_{CC+} + 0.1\text{ V}$ . The transition between the two pairs appears at  $V_{CC+} - 0.7\text{ V}$ . In the transition region, the performance of CMR, SVR,  $V_{iO}$  and THD is slightly degraded (as shown in [Figure 17](#) and [Figure 18](#) for  $V_{iO}$  vs.  $V_{iCM}$ ).

Figure 17. Input offset voltage vs. input common mode at  $V_{CC} = 1.5\text{ V}$

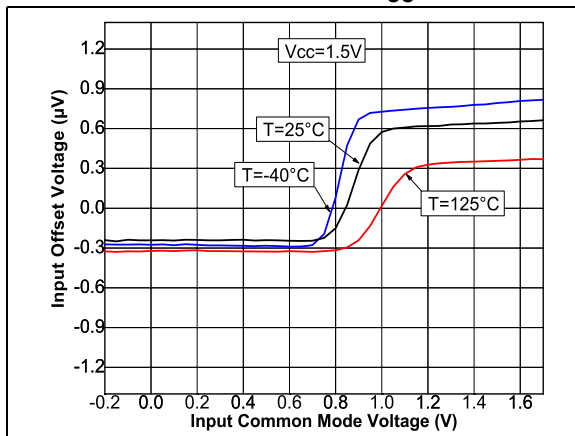
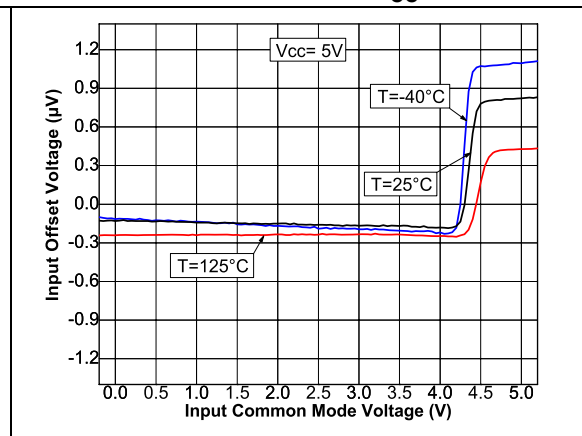

Figure 18. Input offset voltage vs. input common mode at  $V_{CC} = 5\text{ V}$



The devices are guaranteed without phase reversal.

### 3.3 Rail-to-rail output

The operational amplifiers' output levels can go close to the rails: 35 mV maximum above and below the rail when connected to a 10 k $\Omega$  resistive load to  $V_{CC}/2$ .

### 3.4 Shutdown function (TSV6290)

The operational amplifier is enabled when the  $\overline{\text{SHDN}}$  pin is pulled high. To disable the amplifier, the  $\overline{\text{SHDN}}$  must be pulled down to  $V_{CC-}$ . When in shutdown mode, the amplifier's output is in a high impedance state. The  $\overline{\text{SHDN}}$  pin must never be left floating, but tied to  $V_{CC+}$  or  $V_{CC-}$ .

The turn-on and turn-off times are calculated for an output variation of  $\pm 200$  mV (Figure 19 and Figure 20 show the test configurations).

Figure 19. Test configuration for turn-on time (Vout pulled down)

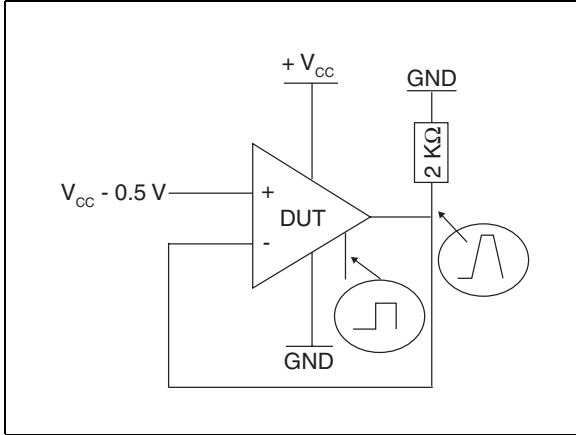

Figure 20. Test configuration for turn-off time (Vout pulled down)

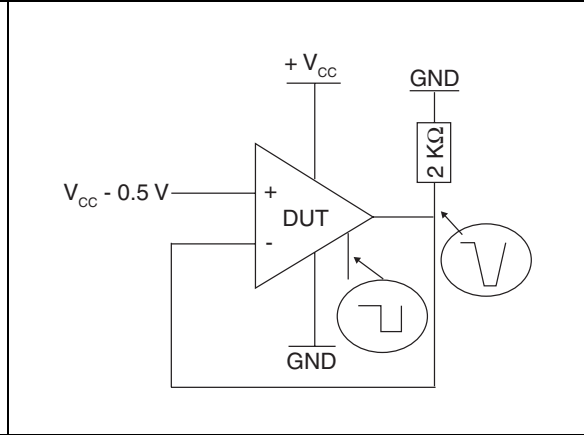

Figure 21. Turn-on time,  $V_{CC} = 5$  V,  $V_{out}$  pulled down,  $T = 25^\circ$  C

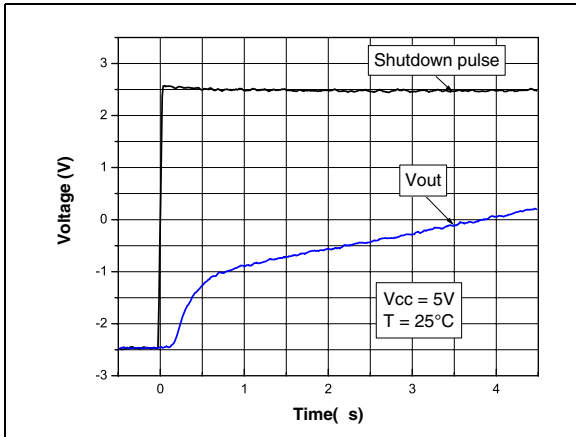
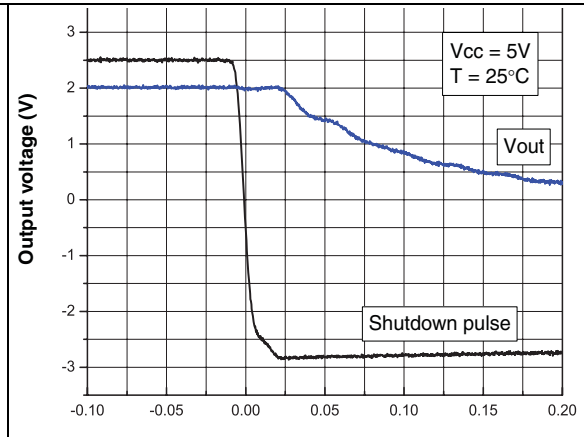

Figure 22. Turn-off time,  $V_{CC} = 5$  V,  $V_{out}$  pulled down,  $T = 25^\circ$  C



### 3.5 Optimization of DC and AC parameters

These devices use an innovative approach to reduce the spread of the main DC and AC parameters. An internal adjustment achieves a very narrow spread of the current consumption (29  $\mu\text{A}$  typical, min/max at  $\pm 17\%$ ). Parameters linked to the current consumption value, such as GBP, SR and  $A_{Vd}$ , benefit from this narrow dispersion.

### 3.6 Driving resistive and capacitive loads

These products are micropower, low-voltage operational amplifiers optimized to drive rather large resistive loads, above 5  $\text{k}\Omega$ . For lower resistive loads, the THD level may significantly increase.

The amplifiers have a relatively low internal compensation capacitor, making them very fast while consuming very little. They are ideal when used in a non-inverting configuration or in an inverting configuration in the following conditions.

- $|G_{\text{gain}}| \geq 3$  in an inverting configuration ( $C_L = 20 \text{ pF}$ ,  $R_L = 100 \text{ k}\Omega$ ) or  $|G_{\text{gain}}| \geq 10$  ( $C_L = 100 \text{ pF}$ ,  $R_L = 100 \text{ k}\Omega$ )
- $G_{\text{gain}} \geq +4$  in a non-inverting configuration ( $C_L = 20 \text{ pF}$ ,  $R_L = 100 \text{ k}\Omega$ ) or  $G_{\text{gain}} \geq +11$  ( $C_L = 100 \text{ pF}$ ,  $R_L = 100 \text{ k}\Omega$ )

As these operational amplifiers are not unity gain stable, for a low closed-loop gain it is recommended to use the TSV62x (29  $\mu\text{A}$ , 420 kHz) or TSV63x (60  $\mu\text{A}$ , 880 kHz) which are unity gain stable.

**Table 8. Related products**

Part #	I <sub>cc</sub> ( $\mu\text{A}$ ) at 5 V	GBP (MHz)	SR (V/ $\mu\text{s}$ )	Minimum gain for stability ( $C_{\text{Load}} = 100 \text{ pF}$ )
TSV620-1	29	0.42	0.14	1
TSV6290-1	29	1.3	0.5	+11
TSV630-1	60	0.88	0.34	1
TSV6390-1	60	2.4	1.1	+11

### 3.7 PCB layouts

For correct operation, it is advised to add 10 nF decoupling capacitors as close as possible to the power supply pins.

### 3.8 Macromodel

An accurate macromodel of the TSV6290 and TSV6291 is available on STMicroelectronics' web site at [www.st.com](http://www.st.com). This model is a trade-off between accuracy and complexity (that is, time simulation) of the TSV629x operational amplifiers. It emulates the nominal performances of a typical device within the specified operating conditions mentioned in the datasheet. It helps to validate a design approach and to select the right operational amplifier, *but it does not replace on-board measurements*.

## 4 Package information

In order to meet environmental requirements, ST offers these devices in different grades of ECOPACK<sup>®</sup> packages, depending on their level of environmental compliance. ECOPACK<sup>®</sup> specifications, grade definitions and product status are available at: [www.st.com](http://www.st.com). ECOPACK<sup>®</sup> is an ST trademark.

### 4.1 SOT23-5 package mechanical data

Figure 23. SOT23-5L package mechanical drawing

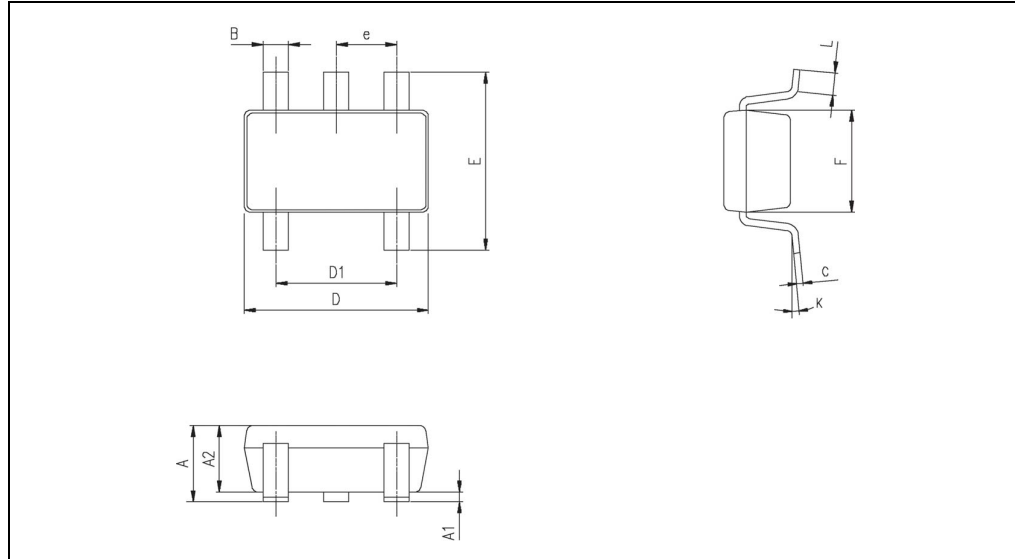

Table 9. SOT23-5L package mechanical data

Ref.	Dimensions					
	Millimeters			Inches		
	Min.	Typ.	Max.	Min.	Typ.	Max.
A	0.90	1.20	1.45	0.035	0.047	0.057
A1			0.15			0.006
A2	0.90	1.05	1.30	0.035	0.041	0.051
B	0.35	0.40	0.50	0.013	0.015	0.019
C	0.09	0.15	0.20	0.003	0.006	0.008
D	2.80	2.90	3.00	0.110	0.114	0.118
D1		1.90			0.075	
e		0.95			0.037	
E	2.60	2.80	3.00	0.102	0.110	0.118
F	1.50	1.60	1.75	0.059	0.063	0.069
L	0.10	0.35	0.60	0.004	0.013	0.023
K	0°		10°			



## 4.2 SOT23-6 package mechanical data

Figure 24. SOT23-6L package mechanical drawing

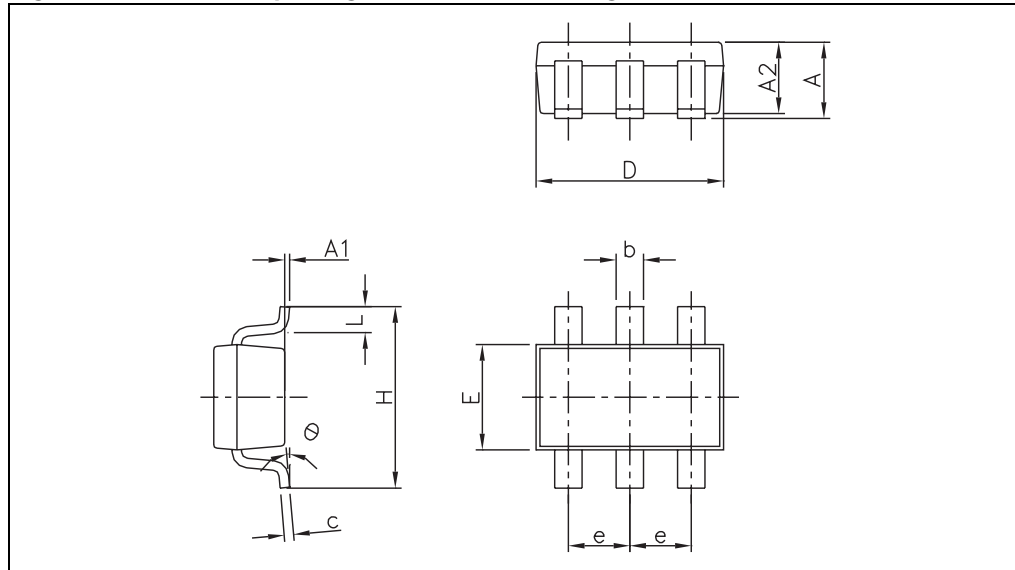

Table 10. SOT23-6L package mechanical data

Ref.	Dimensions					
	Millimeters			Inches		
	Min.	Typ.	Max.	Min.	Typ.	Max.
A	0.90		1.45	0.035		0.057
A1			0.10			0.004
A2	0.90		1.30	0.035		0.051
b	0.35		0.50	0.013		0.019
c	0.09		0.20	0.003		0.008
D	2.80		3.05	0.110		0.120
E	1.50		1.75	0.060		0.069
e		0.95			0.037	
H	2.60		3.00	0.102		0.118
L	0.10		0.60	0.004		0.024
°	0		10°			

### 4.3 SC70-5 (or SOT323-5) package mechanical data

Figure 25. SC70-5 (or SOT323-5) package mechanical drawing

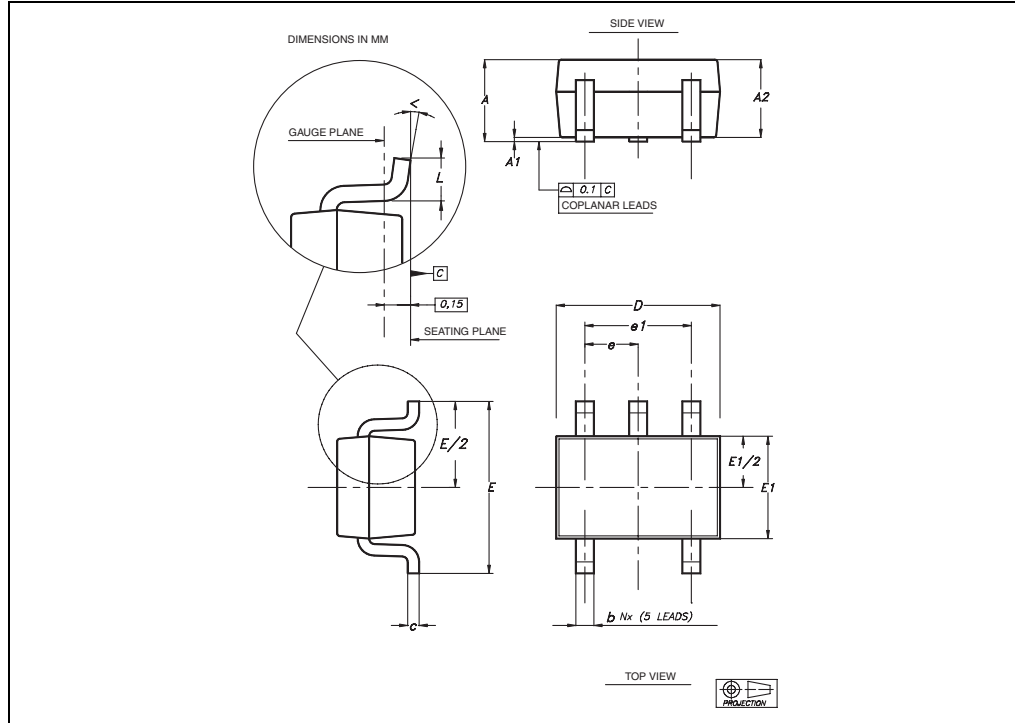

Table 11. SC70-5 (or SOT323-5) package mechanical data

Ref	Dimensions					
	Millimeters			Inches		
	Min	Typ	Max	Min	Typ	Max
A	0.80		1.10	0.315		0.043
A1			0.10			0.004
A2	0.80	0.90	1.00	0.315	0.035	0.039
b	0.15		0.30	0.006		0.012
c	0.10		0.22	0.004		0.009
D	1.80	2.00	2.20	0.071	0.079	0.087
E	1.80	2.10	2.40	0.071	0.083	0.094
E1	1.15	1.25	1.35	0.045	0.049	0.053
e		0.65			0.025	
e1		1.30			0.051	
L	0.26	0.36	0.46	0.010	0.014	0.018
<	0°		8°			

#### 4.4 SC70-6 (or SOT323-6) package mechanical data

Figure 26. SC70-6 (or SOT323-6) package mechanical drawing

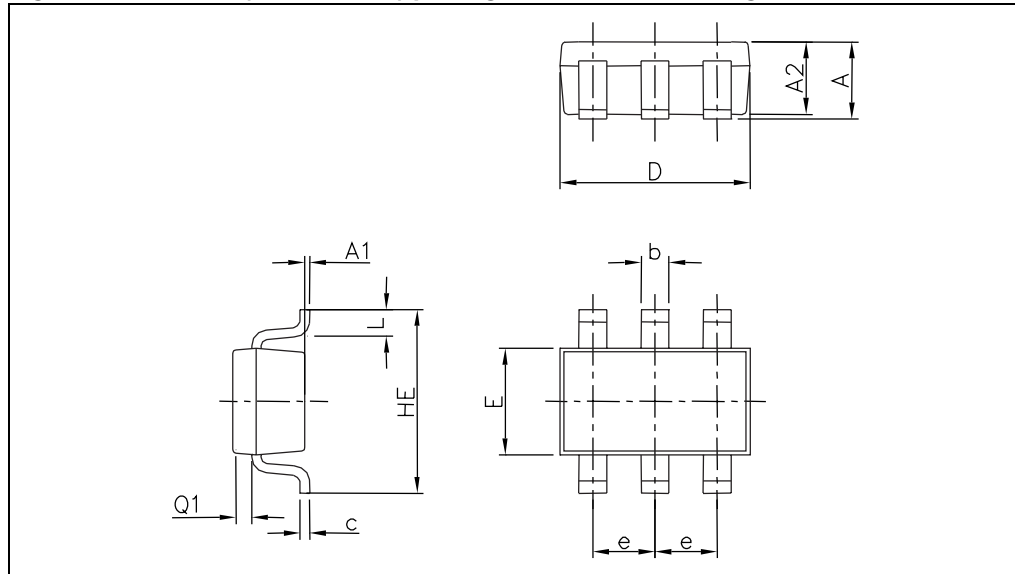
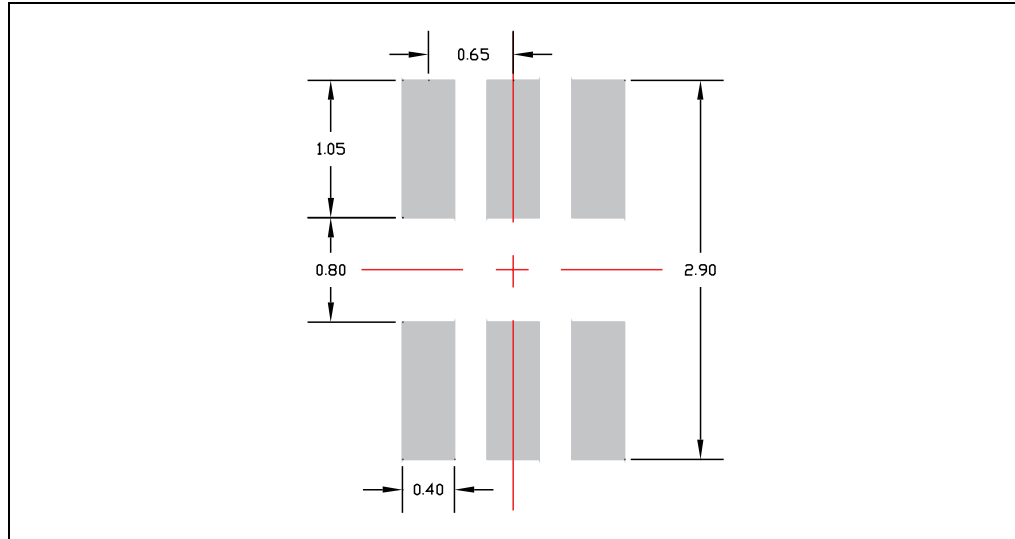

Table 12. SC70-6 (or SOT323-6) package mechanical data

Ref	Dimensions					
	Millimeters			Inches		
	Min.	Typ.	Max.	Min.	Typ.	Max.
A	0.80		1.10	0.031		0.043
A1			0.10			0.004
A2	0.80		1.00	0.031		0.039
b	0.15		0.30	0.006		0.012
c	0.10		0.18	0.004		0.007
D	1.80		2.20	0.071		0.086
E	1.15		1.35	0.045		0.053
e		0.65			0.026	
HE	1.80		2.40	0.071		0.094
L	0.10		0.40	0.004		0.016
Q1	0.10		0.40	0.004		0.016

Figure 27. SC70-6 (or SOT323-6) package footprint



## 5 Ordering information

Table 13. Order codes

Part number	Temperature range	Package	Packing	Marking
TSV6290ILT	-40°C to +125°C	SOT23-6	Tape & reel	K106
TSV6290ICT		SC70-6		K16
TSV6290AILT		SOT23-6		K139
TSV6290AICT		SC70-6		K39
TSV6291ILT		SOT23-5		K107
TSV6291ICT		SC70-5		K14
TSV6291AILT		SOT23-5		K113
TSV6291AICT		SC70-5		K15

## 6 Revision history

Table 14. Document revision history

Date	Revision	Changes
04-Mar-2010	1	Initial release.

**Please Read Carefully:**

Information in this document is provided solely in connection with ST products. STMicroelectronics NV and its subsidiaries ("ST") reserve the right to make changes, corrections, modifications or improvements, to this document, and the products and services described herein at any time, without notice.

All ST products are sold pursuant to ST's terms and conditions of sale.

Purchasers are solely responsible for the choice, selection and use of the ST products and services described herein, and ST assumes no liability whatsoever relating to the choice, selection or use of the ST products and services described herein.

No license, express or implied, by estoppel or otherwise, to any intellectual property rights is granted under this document. If any part of this document refers to any third party products or services it shall not be deemed a license grant by ST for the use of such third party products or services, or any intellectual property contained therein or considered as a warranty covering the use in any manner whatsoever of such third party products or services or any intellectual property contained therein.

**UNLESS OTHERWISE SET FORTH IN ST'S TERMS AND CONDITIONS OF SALE ST DISCLAIMS ANY EXPRESS OR IMPLIED WARRANTY WITH RESPECT TO THE USE AND/OR SALE OF ST PRODUCTS INCLUDING WITHOUT LIMITATION IMPLIED WARRANTIES OF MERCHANTABILITY, FITNESS FOR A PARTICULAR PURPOSE (AND THEIR EQUIVALENTS UNDER THE LAWS OF ANY JURISDICTION), OR INFRINGEMENT OF ANY PATENT, COPYRIGHT OR OTHER INTELLECTUAL PROPERTY RIGHT.**

**UNLESS EXPRESSLY APPROVED IN WRITING BY AN AUTHORIZED ST REPRESENTATIVE, ST PRODUCTS ARE NOT RECOMMENDED, AUTHORIZED OR WARRANTED FOR USE IN MILITARY, AIR CRAFT, SPACE, LIFE SAVING, OR LIFE SUSTAINING APPLICATIONS, NOR IN PRODUCTS OR SYSTEMS WHERE FAILURE OR MALFUNCTION MAY RESULT IN PERSONAL INJURY, DEATH, OR SEVERE PROPERTY OR ENVIRONMENTAL DAMAGE. ST PRODUCTS WHICH ARE NOT SPECIFIED AS "AUTOMOTIVE GRADE" MAY ONLY BE USED IN AUTOMOTIVE APPLICATIONS AT USER'S OWN RISK.**

Resale of ST products with provisions different from the statements and/or technical features set forth in this document shall immediately void any warranty granted by ST for the ST product or service described herein and shall not create or extend in any manner whatsoever, any liability of ST.

ST and the ST logo are trademarks or registered trademarks of ST in various countries.

Information in this document supersedes and replaces all information previously supplied.

The ST logo is a registered trademark of STMicroelectronics. All other names are the property of their respective owners.

© 2010 STMicroelectronics - All rights reserved

STMicroelectronics group of companies

Australia - Belgium - Brazil - Canada - China - Czech Republic - Finland - France - Germany - Hong Kong - India - Israel - Italy - Japan - Malaysia - Malta - Morocco - Philippines - Singapore - Spain - Sweden - Switzerland - United Kingdom - United States of America

[www.st.com](http://www.st.com)

