

ACPL-4800

High CMR Intelligent Power Module and Gate Drive Interface Optocoupler



Data Sheet



Lead (Pb) Free
RoHS 6 fully compliant

RoHS 6 fully compliant options available;
-xxxE denotes a lead-free product

Description

The ACPL-4800 fast speed optocoupler contains a GaAsP LED and photo detector with built-in Schmitt trigger to provide logic-compatible waveforms, eliminating the need for additional wave shaping. The totem pole output eliminates the need for a pull up resistor and allows for direct drive Intelligent Power Module or gate drive.

Functional Diagram

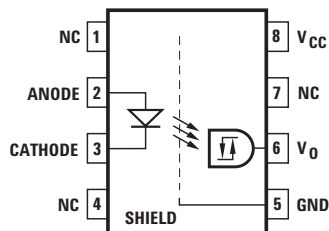

TRUTH TABLE
(POSITIVE LOGIC)

LED	V _O
ON	HIGH
OFF	LOW

Note: The connection of a 0.1 μ F bypass capacitor between pins 5 & 8 is recommended.

Schematic

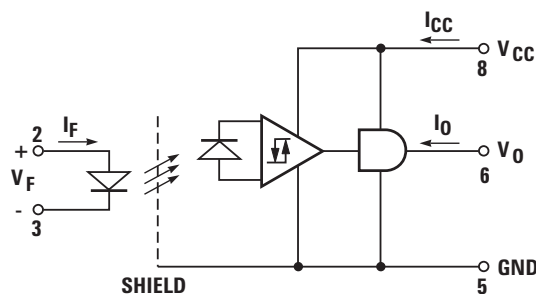

Features

- Performance Specified for Fast IPM Applications over Industrial Temperature Range: -40°C to 100°C
- Wide Operating V_{CC} Range: 4.5 to 20 Volts
- Typical Propagation Delays 150 ns
- Maximum Pulse Width Distortion PWD = 250 ns
- Propagation Delay Difference Min. -100 ns, Max. 250 ns
- 30 kV/ μ s Minimum Common Mode Transient Immunity at V_{CM} = 1000 V
- Hysteresis
- Totem Pole Output (No Pull-up Resistor Required)
- Safety Approval:
UL 1577, 3750 V_{rms} / 1 minute
CSA File CA88324, Notice #5
IEC/EN/DIN EN 60747-5-2, V_{IORM} = 630 V_{peak}

Applications

- IPM Interface Isolation
- Isolated IGBT/MOSFET Gate Drive
- AC and Brushless DC Servo Motor Drives
- Low Power Inverters
- General Digital Isolation

CAUTION: It is advised that normal static precautions be taken in handling and assembly of this component to prevent damage and /or degradation which may be induced by ESD.

Ordering Information

ACPL-4800 is UL Recognized with 3750 Vrms for 1 minute per UL1577 and is approved under CSA Component Acceptance Notice #5, File CA 88324.

Part number	Option					IEC/EN/DIN EN 60747-5-2	Quantity	
	RoHS Compliant	Package	Surface Mount	Gull Wing	Tape & Reel			
ACPL-4800	-000E	300mil DIP-8					50 per tube	
	-300E		X	X			50 per tube	
	-500E		X	X	X		1000 per reel	
	-060E						X	50 per tube
	-360E		X	X			X	50 per tube
	-560E		X	X	X	X	X	1000 per reel

To order, choose a part number from the part number column and combine with the desired option from the option column to form an order entry.

Example 1:

ACPL-4800-560E to order product of 300mil DIP Gull Wing Surface Mount package in Tape and Reel packaging with IEC/EN/DIN EN 60747-5-2 Safety Approval in RoHS compliant.

Example 2:

ACPL-4800-000E to order product of 300mil DIP package in tube packaging and RoHS compliant.

Option datasheets are available. Contact your Avago sales representative or authorized distributor for information.

Package Outline Drawings

DIP-8 Package

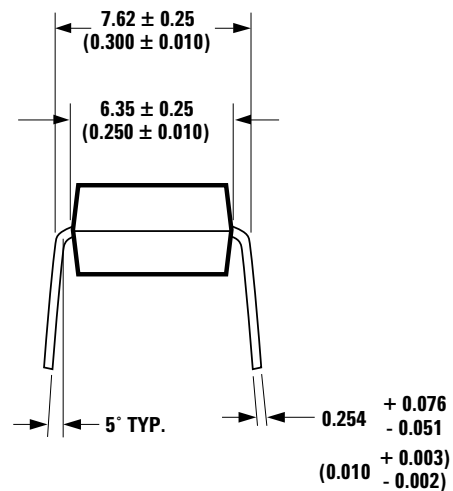
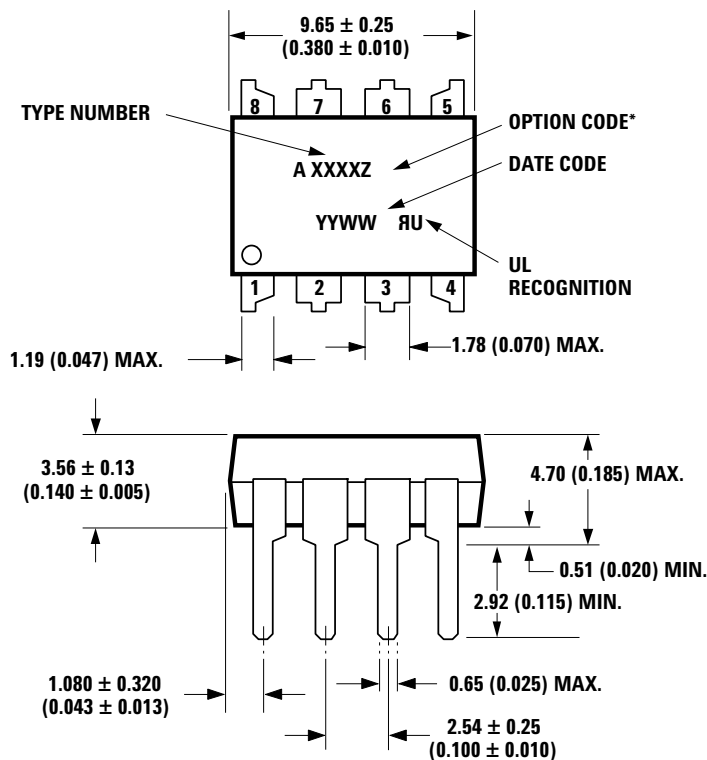

DIMENSIONS IN MILLIMETERS AND (INCHES).
 * MARKING CODE LETTER FOR OPTION NUMBERS
 "V" = OPTION 060
 OPTION NUMBERS 300 AND 500 NOT MARKED.

DIP-8 Package with Gull Wing Surface Mount Option 300

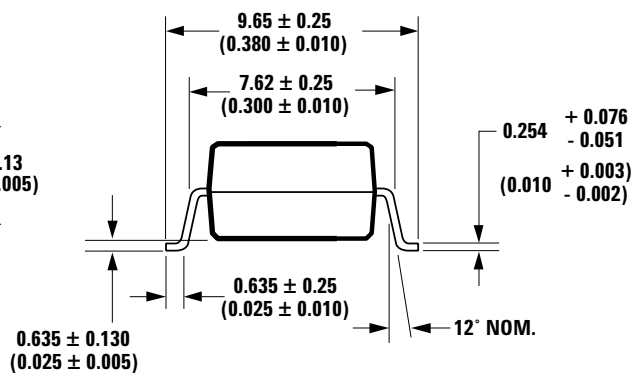
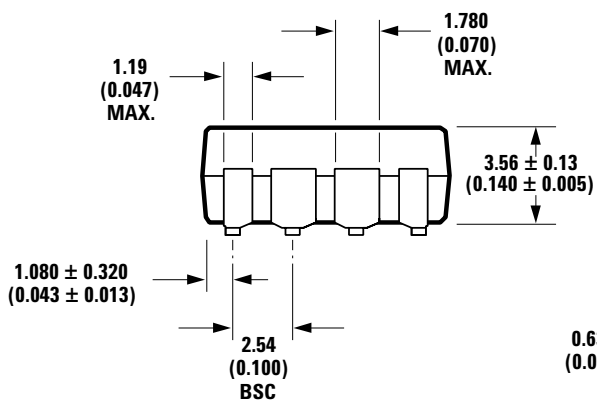
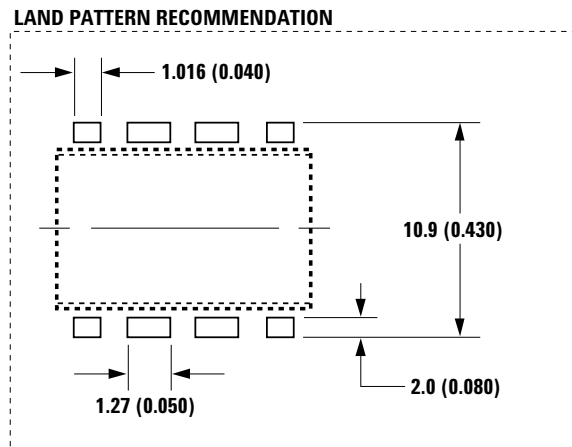
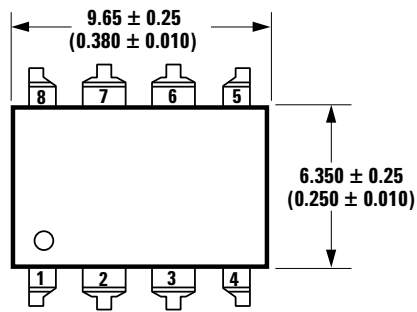

DIMENSIONS IN MILLIMETERS (INCHES).
LEAD COPLANARITY = 0.10 mm (0.004 INCHES).

NOTE: FLOATING LEAD PROTRUSION IS 0.25 mm (10 mils) MAX.

Solder Reflow Temperature Profile (Gull Wing Surface Mount Option 300 Parts)

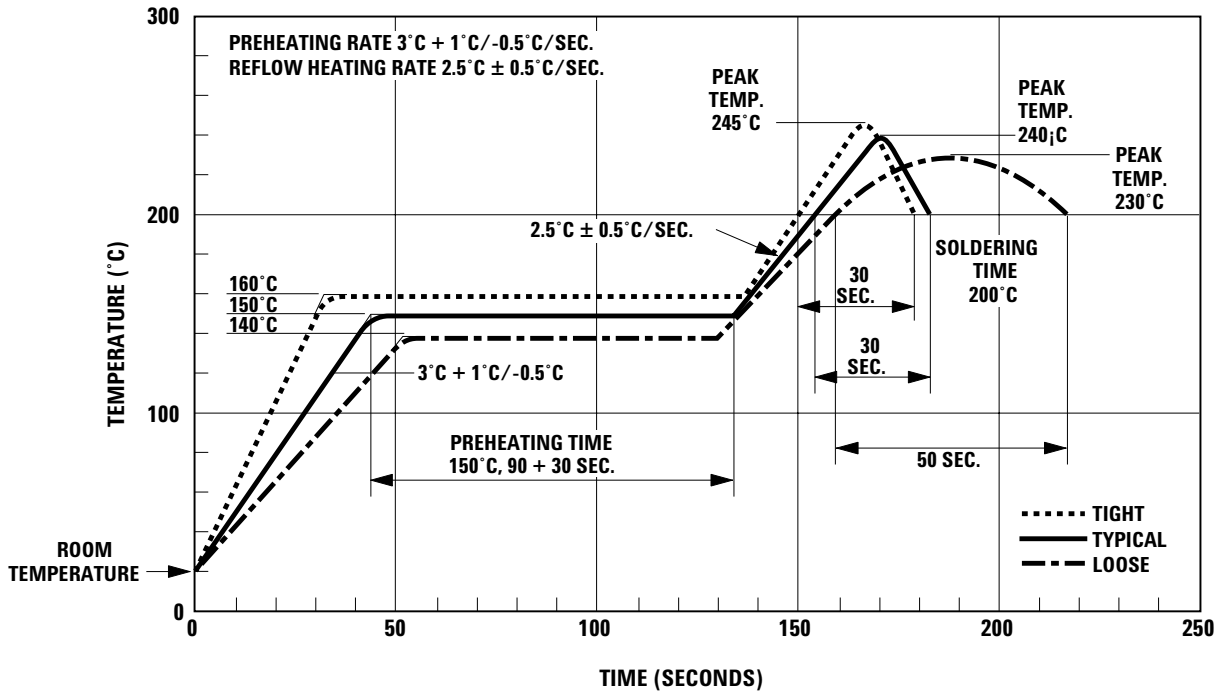

Note: Non-halide flux should be used

Recommended Pb-Free IR Profile

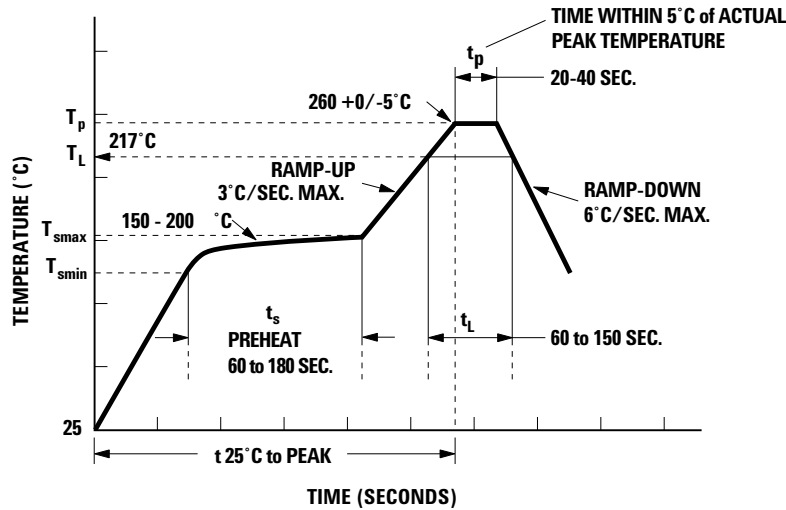

NOTES:
 THE TIME FROM 25 C to PEAK TEMPERATURE = 8 MINUTES MAX.
 $T_{smax} = 200^{\circ}\text{C}$, $T_{smin} = 150^{\circ}\text{C}$

Note: Non-halide flux should be used

Insulation and Safety Related Specifications

Parameter	Symbol	8-Pin DIP	Unit	Conditions
Minimum External Air Gap(External Clearance)	L(101)	7.1	mm	Measured from input terminals to output terminals, shortest distance through air.
Minimum External Tracking (External Creepage)	L(102)	7.4	mm	Measured from input terminals to output terminals, shortest distance path along body.
Minimum Internal Plastic Gap (Internal Clearance)		0.08		Through insulation distance, conductor to conductor, usually the direct distance between the photo emitter and photo detector inside the optocoupler cavity.
Minimum Internal Tracking (Internal Creepage)		NA	mm	Measured from input terminals to output terminals, along internal cavity.
Tracking Resistance (Comparative Tracking Index)	CTI	200	mm	DIN IEC 112/VDE 0303 Part 1
Isolation Group		IIIa		Material Group (DIN VDE 0110, 1/89, Table 1)

Option 300 - surface mount classification is Class A in accordance with CECC 00802.

IEC/EN/DIN EN 60747-5-2 Insulation Characteristics (Option 060)

Description	Symbol	Characteristic	Unit
Installation classification per DIN VDE 0110/1.89, Table 1			
for rated mains voltage $\leq 300 V_{rms}$		I-IV	
for rated mains voltage $\leq 450 V_{rms}$		I-III	
Climatic Classification		55/85/21	
Pollution Degree (DIN VDE 0110/1.89)		2	
Maximum Working Insulation Voltage	V_{IORM}	630	V_{peak}
Input to Output Test Voltage, Method b* $V_{IORM} \times 1.875 = V_{PR}$, 100% Production Test with $t_m = 1$ sec, Partial discharge < 5 pC	V_{PR}	1181	V_{peak}
Input to Output Test Voltage, Method a* $V_{IORM} \times 1.5 = V_{PR}$, Type and Sample Test, $t_m = 60$ sec, Partial discharge < 5 pC	V_{PR}	945	V_{peak}
Highest Allowable Over-voltage(Transient Over-voltage $t_{ini} = 10$ sec)	V_{IOTM}	6000	V_{peak}
Safety-limiting values - maximum values allowed in the event of a failure.			
Case Temperature	T_S	175	$^{\circ}C$
Input Current	$I_{S, INPUT}$	230	mA
Output Power (refer to Thermal Derating Curve)	$P_{S, OUT-PUT}$	600	mW
Insulation Resistance at T_S , $V_{IO} = 500$ V	R_S	$> 10^9$	Ω

* Refer to the optocoupler section of the Isolation and Control Components Designer's Catalog, under Product Safety Regulations section, (IEC/EN/DIN EN 60747-5-2) for a detailed description of Method a and Method b partial discharge test profiles.

Note:

Isolation characteristics are guaranteed only within the safety maximum ratings which must be ensured by protective circuits in application.

Thermal Derating Curve

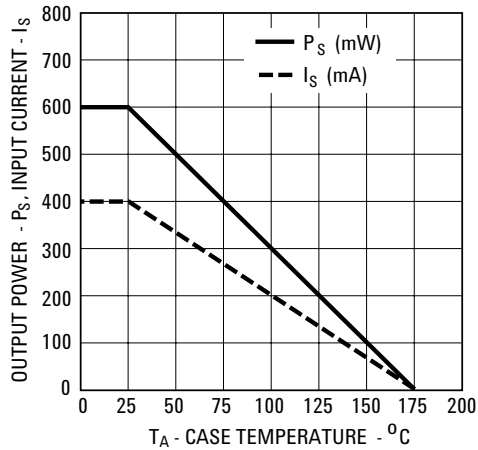

Absolute Maximum Rating

Parameter	Symbol	Min.	Max.	Units	Note
Storage Temperature	T _S	-55	125	°C	
Operating Temperature	T _A	-40	100	°C	
Average Forward Input Current	I _{F(AVG)}		10	mA	
Peak Transient Input Current (≤ 1 μs Pulse Width, 300 pps) (≤ 200 μs Pulse Width, < 1% Duty Cycle)	I _{F(TRAN)}		1.0 40	A mA	
Reverse Input Voltage	V _R		5	V	
Average Output Current	I _O		25	mA	
Supply Voltage	V _{CC}	0	25	V	
Output Voltage	V _O	-0.5	25	V	
Total Package Power Dissipation	P _T		210	mW	1
Lead Solder Temperature (Through Hole Parts Only)		260 °C for 10 sec., 1.6 mm below seating plane			
Solder Reflow Temperature Profile (Surface Mount Parts Only)		See Package Outline Drawings section			

Recommended Operating Conditions

Parameter	Symbol	Min.	Max.	Units
Power Supply Voltage	V _{CC}	4.5	20	V
Forward Input Current (ON)	I _{F(ON)}	6	10	mA
Forward Input Voltage (OFF)	V _{F(OFF)}	-	0.8	V
Operating Temperature	T _A	-40	100	°C

Electrical Specification

$-40^{\circ}\text{C} \leq T_A \leq 100^{\circ}\text{C}$, $4.5\text{V} \leq V_{CC} \leq 20\text{V}$, $6\text{mA} \leq I_{F(\text{ON})} \leq 10\text{mA}$, $0\text{V} \leq V_{F(\text{OFF})} \leq 0.8\text{V}$, unless otherwise specified.

All Typicals at $T_A = 25^{\circ}\text{C}$.

Parameter	Sym.	Min.	Typ.	Max.	Units	Test Conditions	Fig.	Note
Logic Low Output Voltage	V_{OL}			0.5	V	$I_{OL} = 6.4\text{mA}$	1, 3	
Logic High Output Voltage	V_{OH}	2.4	$V_{CC} - 1.1\text{V}$		V	$I_{OH} = -2.6\text{mA}$ $I_{OH} = -0.4\text{mA}$	2, 3, 7	
Output Leakage Current ($V_{OUT} = V_{CC} + 0.5\text{V}$)	I_{OHH}			100 500	μA	$V_{CC} = 5\text{V}$ $V_{CC} = 20\text{V}$	$I_F = 10\text{mA}$	
Logic Low Supply Current	I_{CCL}		1.9 2.0	3.0 3.0	mA	$V_{CC} = 5.5\text{V}$ $V_{CC} = 20\text{V}$	$V_F = 0\text{V}$ $I_O = \text{Open}$	
Logic High Supply Current	I_{CCH}		1.5 1.6	2.5 2.5	mA	$V_{CC} = 5.5\text{V}$ $V_{CC} = 20\text{V}$	$I_F = 10\text{mA}$ $I_O = \text{Open}$	
Logic Low Short Circuit Output Current	I_{OSL}	25 50			mA	$V_O = V_{CC} = 5.5\text{V}$ $V_O = V_{CC} = 20\text{V}$	$V_F = 0\text{V}$	2
Logic High Short Circuit Output Current	I_{OSH}			-25 -50	mA	$V_{CC} = 5.5\text{V}$ $V_{CC} = 20\text{V}$	$I_F = 6\text{mA}$ $V_O = \text{GND}$	2
Input Forward Voltage	V_F		1.5	1.7 1.85	V	$T_A = 25\text{C}$	$I_F = 6\text{mA}$	4
Input Reverse Breakdown Voltage	BV_R	5			V	$I_R = 10\ \mu\text{A}$		
Input Diode Temperature Coefficient	ΔV_F ΔT_A		-1.7		mV/ $^{\circ}\text{C}$	$I_F = 6\text{mA}$		
Input Capacitance	C_{IN}		60		pF	$f = 1\text{MHz}$, $V_F = 0\text{V}$		3

Switching Specifications (AC)

$-40^{\circ}\text{C} \leq T_A \leq 100^{\circ}\text{C}$, $4.5\text{V} \leq V_{\text{CC}} \leq 20\text{V}$, $6\text{mA} \leq I_{\text{F(ON)}} \leq 10\text{mA}$, $0\text{V} \leq V_{\text{F(OFF)}} \leq 0.8\text{V}$.

All Typicals at $T_A = 25^{\circ}\text{C}$, $I_{\text{F(ON)}} = 6\text{mA}$ unless otherwise specified.

Parameter	Sym.	Min.	Typ.	Max.	Units	Test Conditions	Fig.	Note
Propagation Delay Time to Logic Low Output Level	t_{PHL}		150	350	ns	With Peaking Capacitor	5,6	5
Propagation Delay Time to Logic High Output Level	t_{PLH}		110	350	ns	With Peaking Capacitor	5,6	5
Pulse Width Distortion	PWD			250	ns	$ t_{\text{PHL}} - t_{\text{PLH}} $		8
Propagation Delay Difference Between Any 2 Parts	PDD	-100		250	ns			10
Output Rise Time (10-90%)	t_r		16		ns		5,8	
Output Fall Time (90-10%)	t_f		20		ns		5,8	
Logic High Common Mode Transient Immunity	$ C_{\text{MH}} $	-30000			V/ μs	$ V_{\text{CM}} = 1000\text{V}$, $I_{\text{F}} = 6.0\text{mA}$, $V_{\text{CC}} = 5\text{V}$, $T_A = 25^{\circ}\text{C}$	9	6
Logic Low Common Mode Transient Immunity	$ C_{\text{ML}} $	30000			V/ μs	$ V_{\text{CM}} = 1000\text{V}$, $V_{\text{F}} = 0\text{V}$, $V_{\text{CC}} = 5\text{V}$, $T_A = 25^{\circ}\text{C}$	9	6

Package Characteristics

Parameter	Sym.	Min.	Typ.	Max.	Units	Test Conditions	Fig.	Note
Input-Output Momentary Withstand Voltage*	V_{ISO}	3750			V_{rms}	$\text{RH} < 50\%$, $t = 1\text{min.}$, $T_A = 25^{\circ}\text{C}$		4,7
Input-Output Resistance	$R_{\text{I-O}}$		10^{12}		Ω	$V_{\text{I-O}} = 500\text{Vdc}$		4
Input-Output Capacitance	$C_{\text{I-O}}$		0.6		pF	$f = 1\text{MHz}$, $V_{\text{I-O}} = 0\text{Vdc}$		4

* The Input-Output Momentary Withstand Voltage is a dielectric voltage rating that should not be interpreted as an input-output continuous voltage rating. For the continuous voltage rating refer to the IEC/EN/DIN EN 60747-5-2 Insulation Characteristics Table (if applicable), your equipment level safety specification or Avago Application Note 1074 entitled "Optocoupler Input-Output Endurance Voltage," publication number 5963-2203E.

Notes:

- Derate total package power dissipation, P_T , linearly above 70°C free-air temperature at a rate of $4.5\text{mW}/^{\circ}\text{C}$.
- Duration of output short circuit time should not exceed 10 ms.
- Input capacitance is measured between pin 2 and pin 3.
- Device considered a two-terminal device: pins 1, 2, 3, and 4 shorted together and pins 5, 6, 7, and 8 shorted together.
- The t_{PLH} propagation delay is measured from the 50% point on the leading edge of the input pulse to the 1.3 V point on the leading edge of the output pulse. The t_{PHL} propagation delay is measured from the 50% point on the trailing edge of the input pulse to the 1.3 V point on the trailing edge of the output pulse.
- C_{MH} is the maximum slew rate of the common mode voltage that can be sustained with the output voltage in the logic high state, $V_O > 2.0\text{V}$. C_{ML} is the maximum slew rate of the common mode voltage that can be sustained with the output voltage in the logic low state, $V_O < 0.8\text{V}$.
- In accordance with UL 1577, each optocoupler is proof tested by applying an insulation test voltage $\geq 4500\text{V rms}$ for one second (leakage detection current limit, $\text{II-O} \leq 5\mu\text{A}$). This test is performed before the 100% production test for partial discharge (Method b) shown in the IEC/EN/DIN EN 60747-5-2 Insulation Characteristics Table, if applicable.
- Pulse Width Distortion (PWD) is defined as $|t_{\text{PHL}} - t_{\text{PLH}}|$ for any given device.
- Use of a $0.1\mu\text{F}$ bypass capacitor connected between pins 5 and 8 is recommended.
- The difference between t_{PLH} and t_{PHL} between any two devices under the same test condition.

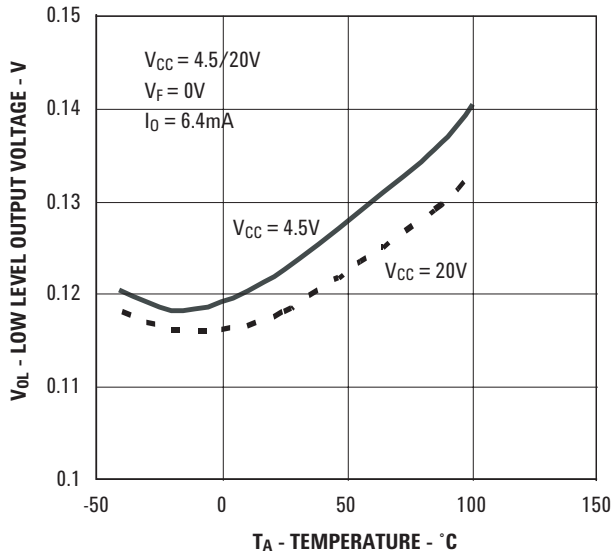

Figure 1. Typical Logic Low Output Voltage vs. Temperature

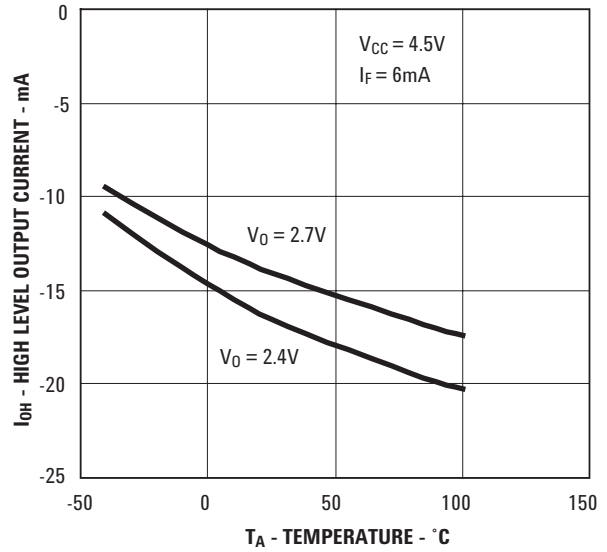

Figure 2. Typical Logic High Output Current vs. Temperature

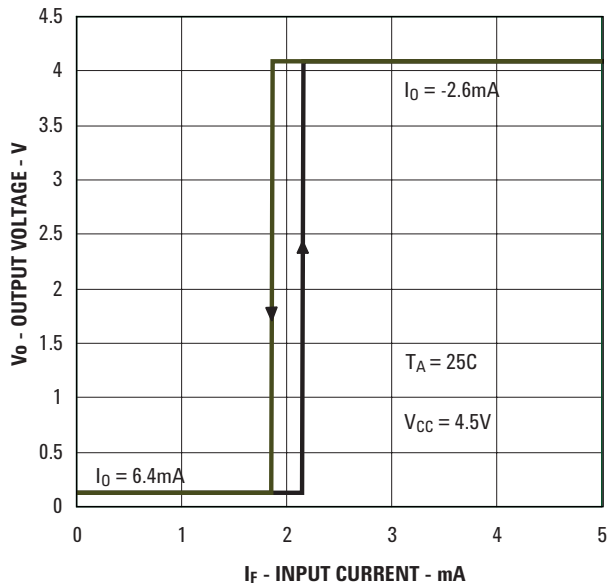

Figure 3. Typical Output Voltage vs. Forward Input Current

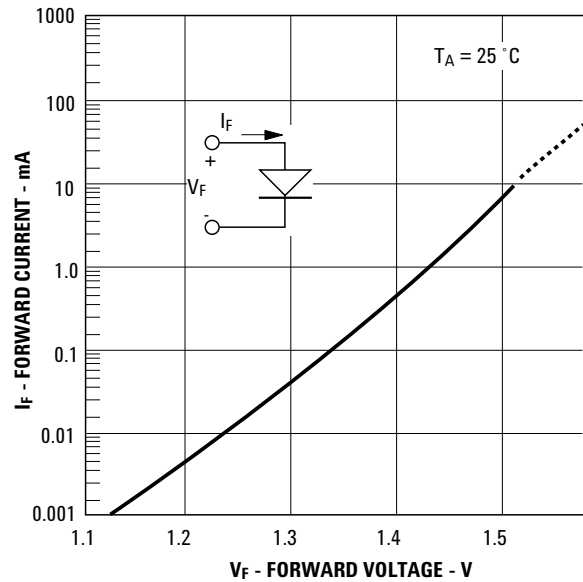

Figure 4. Typical Input Diode Forward Characteristic

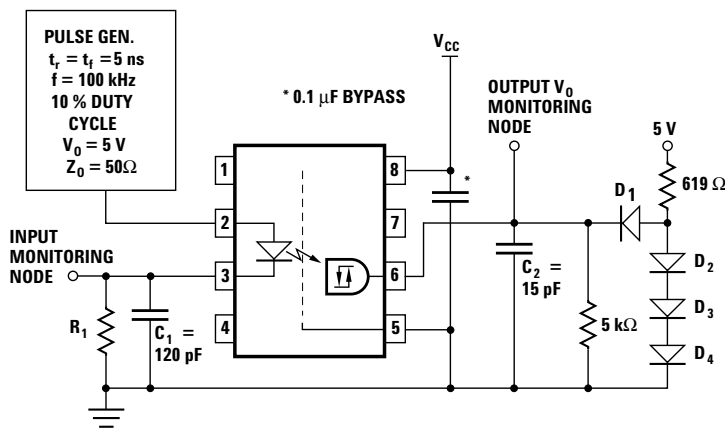
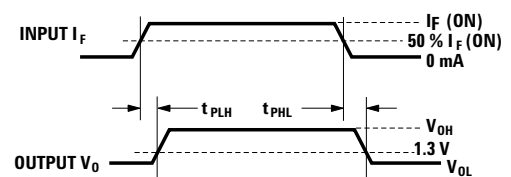

Figure 5. Test Circuit for t_{PLH} , t_{PHL} , t_r , t_f

THE PROBE AND JIG CAPACITANCES ARE INCLUDED IN C1 AND C2.

R_1	1.10 k Ω	681 Ω	330 Ω
I_F (ON)	3 mA	5 mA	10 mA

ALL DIODES ARE 1N916 OR 1N3064.



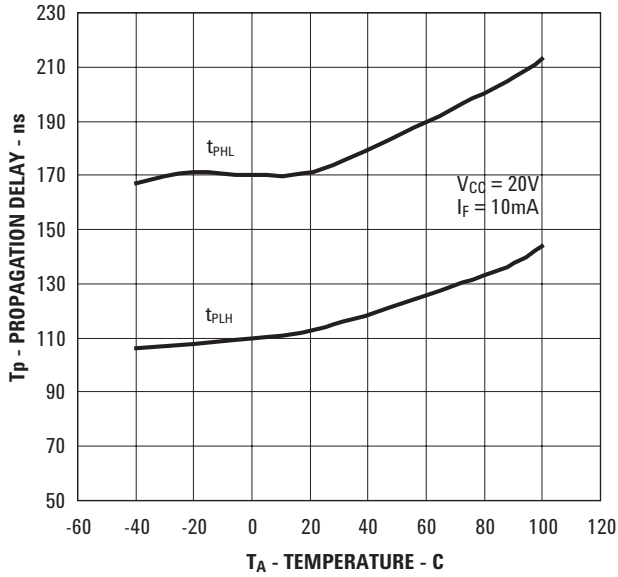

Figure 6. Typical Propagation Delays vs. Temperature.

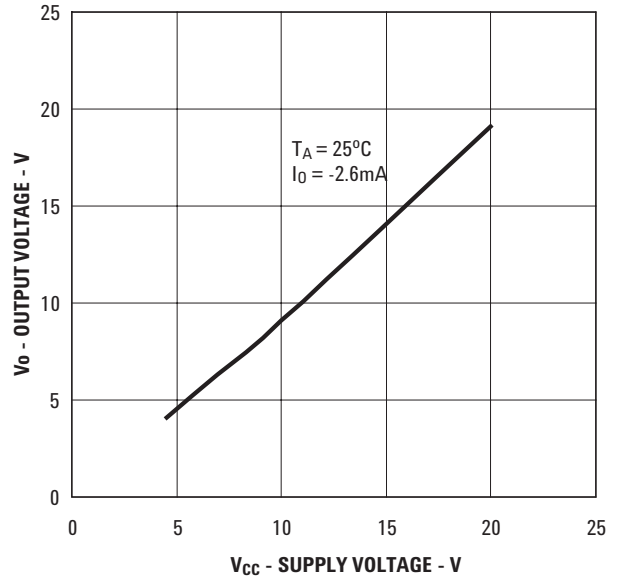

Figure 7. Typical Logic High Output Voltage vs. Supply Voltage

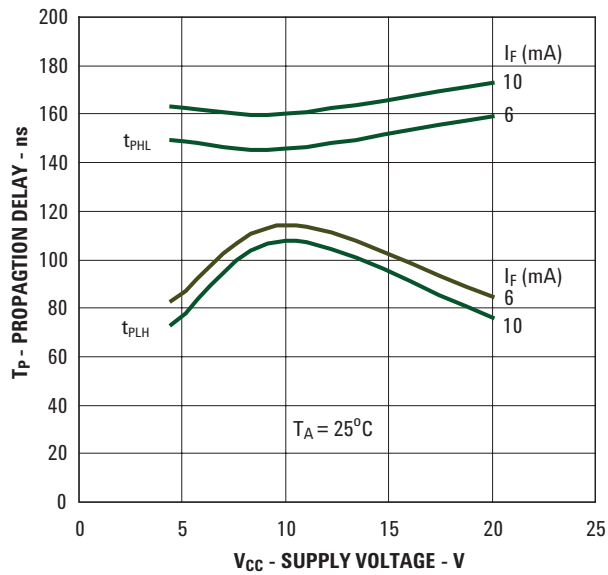

Figure 8. Typical Propagation Delay vs. Supply Voltage

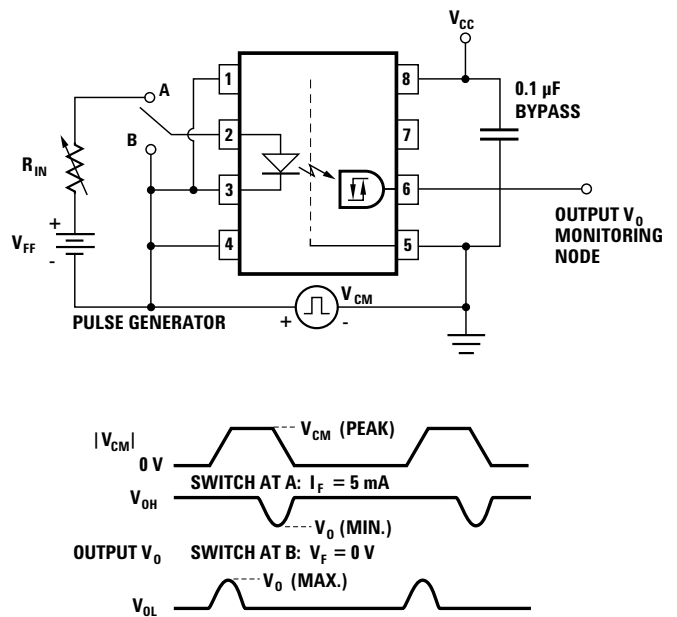

Figure 9. Test Circuit for Common Mode Transient Immunity and Typical Waveforms

For product information and a complete list of distributors, please go to our web site: www.avagotech.com

Avago, Avago Technologies, and the A logo are trademarks of Avago Technologies, Limited in the United States and other countries. Data subject to change. Copyright © 2006 Avago Technologies Limited. All rights reserved. AV01-0193EN - June 13, 2007

AVAGO
TECHNOLOGIES