

J-FET INPUT OPERATIONAL AMPLIFIER

■ GENERAL DESCRIPTION

The NJM062/064 are J-FET input operational amplifiers which were designed as low-power versions of the NJM082. They feature high input impedance, wide bandwidth, high slew rate, and low input offset and bias current.

The NJM062 features the same terminal assignments as the NJM4558/2043/2904/3404/072 and NJM064 features the same terminal assignments as the NJM2902/3403/2058/2059/2060.

Each of these JFET-input operational amplifiers incorporates well-matched, high voltage JFET and bipolar transistors in a monolithic integrated circuit.

■ PACKAGE OUTLINE

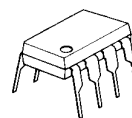

NJM062D



NJM062M

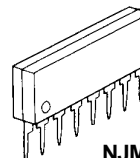

NJM062L



NJM062V

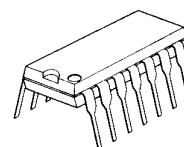

NJM064D

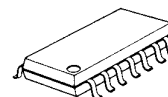

NJM064M



NJM064V

■ FEATURES

- Operating Voltage ($\pm 2V \sim \pm 18V$)
- J-FET Input
- High Input Resistance ($10^{12}\Omega$ typ.)
- Low Operating Current ($200\mu A/circuit$ typ.)
- High Slew Rate ($3.5V/\mu s$ typ.)
- Wide Unity Gain Bandwidth (1MHz typ.)
- Package Outline DIP8/14, DMP8/14, SSOP8/14, SIP8
- Bipolar Technology

■ PIN CONFIGURATION

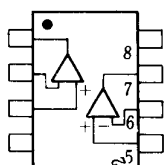

NJM062D
NJM062M
NJM062V

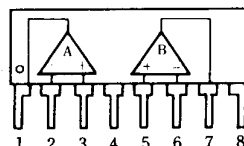

NJM062L

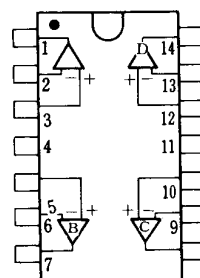

NJM064D
NJM064M
NJM064V

PIN FUNCTION

- 1.A OUTPUT
- 2.A -INPUT
- 3.A +INPUT
- 4.V⁺
- 5.B +INPUT
- 6.B -INPUT
- 7.B OUTPUT
- 8.V⁺

PIN FUNCTION

1. A OUTPUT
2. A -INPUT
3. A +INPUT
4. V⁺
5. B +INPUT
6. B -INPUT
7. B OUTPUT
8. C OUTPUT
9. C -INPUT
10. C +INPUT
11. V⁺
12. D +INPUT
13. D -INPUT
14. D OUTPUT

NJM062/064

■ EQUIVALENT CIRCUIT (062 is 1/2 Shown.064 is 1/4 Shown.)

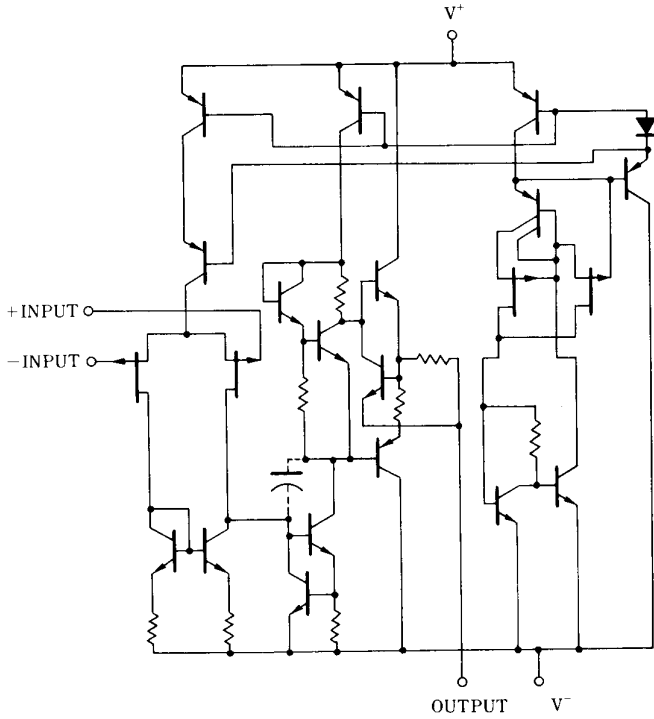

■ ABSOLUTE MAXIMUM RATINGS

(Ta=25°C)

PARAMETER	SYMBOL	RATINGS	UNIT
Supply Voltage	V^+V^-	± 18	V
Differential Input Voltage	V_{ID}	± 30	V
Input Voltage	V_{IC}	± 15	V
Power Dissipation	P_D	(DIP8) 500 (DMP8) 300 (SIP8) 800 (SSOP8) 250 (DIP14) 700 (DMP14) 700 (note2) (SSOP14) 300	mW
Operating Temperature Range	T_{opr}	-40~+85	°C
Storage Temperature Range	T_{stg}	-40~+125	°C

(note1) For supply voltage less than ±15V. The absolute maximum input voltage is equal to the supply voltage.

(note2) At on PC board

■ ELECTRICAL CHARACTERISTICS

(V^+V^- =±15V, Ta=25°C)

PARAMETER	SYMBOL	TEST CONDITION	MIN.	TYP.	MAX.	UNIT
Operating Supply Voltage	V^+V^-		± 2	-	± 18	V
Input Offset Voltage	V_{IO}	$R_S=50\Omega$	-	3	15	mV
Input Offset Current	I_{IO}		-	1	200	pA
Input Bias Current	I_B		-	2	400	pA
Input Common Mode Voltage Range	V_{ICM}		± 13	+15 -13.5	-	V
Maximum Peak-to-peak Output Voltage Swing	V_{OM}	$R_L=10k\Omega$	± 13	+14.2 -14.0	-	V
Large-signal Voltage Gain	A_V	$R_L \geq 10k\Omega, V_O = \pm 10V$	70	80	-	dB
Unity Gain Bandwidth	f_T	$R_L=10k\Omega$	-	1	-	MHz
Input Resistance	R_{IN}		-	10^{12}	-	Ω
Common Mode Rejection Ratio	CMR	$R_S \leq 10k\Omega$	70	90	-	dB
Supply Voltage Rejection Ratio	SVR	$R_S \leq 10k\Omega$	70	100	-	dB
Operating Current	I_{CC}	$R_L = \infty$ each amplifier	-	200	250	μA
Slew Rate	SR	$R_L=10k\Omega$	-	3.5	-	V/ μs
Equivalent Input Noise Voltage	e_n	$R_S=100\Omega, f=1kHz$	-	35	-	nV/ \sqrt{Hz}

TYPICAL CHARACTERISTICS

Voltage Gain, Phase Shift vs. Frequency

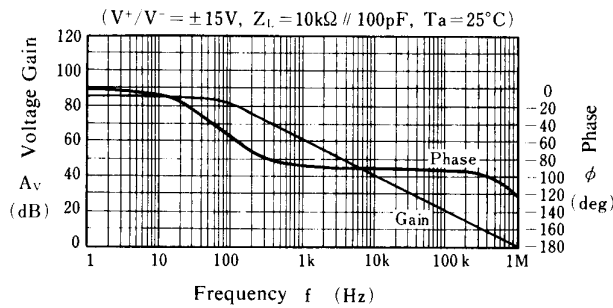

Maximum Output Voltage Swing vs. Frequency

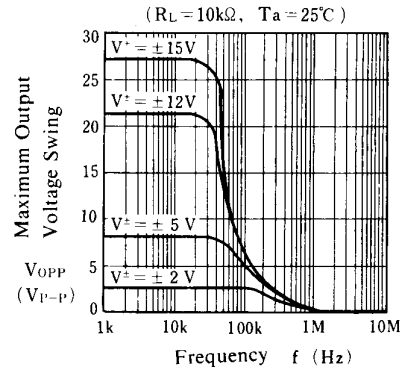

Maximum Output Voltage Swing vs. Load Resistance

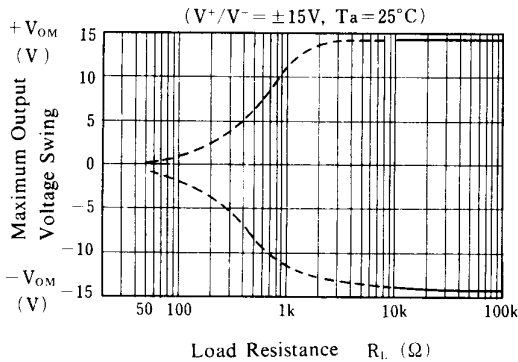

Maximum Output Voltage Swing vs. Output Current

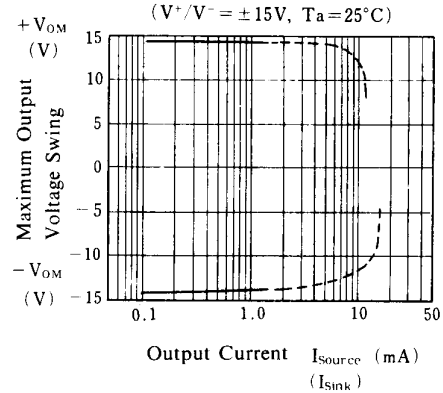

Equivalent Input Noise Voltage vs. Frequency

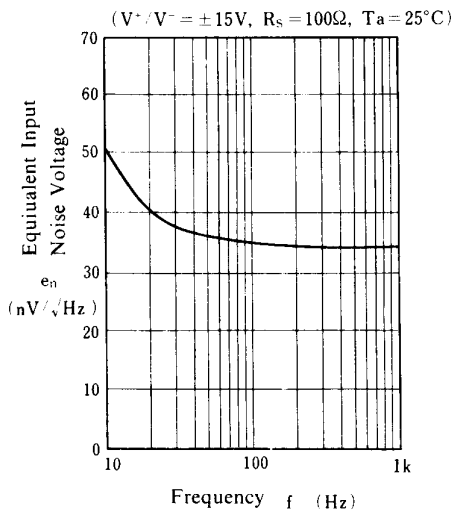

Voltage Follower Large Signal Pulse Response

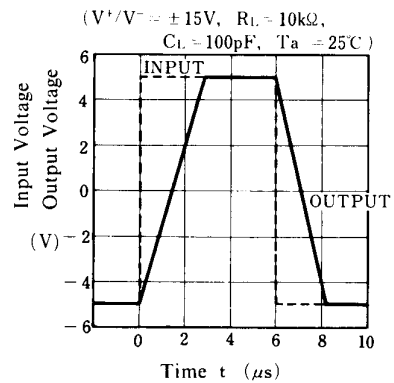

■ TYPICAL CHARACTERISTICS

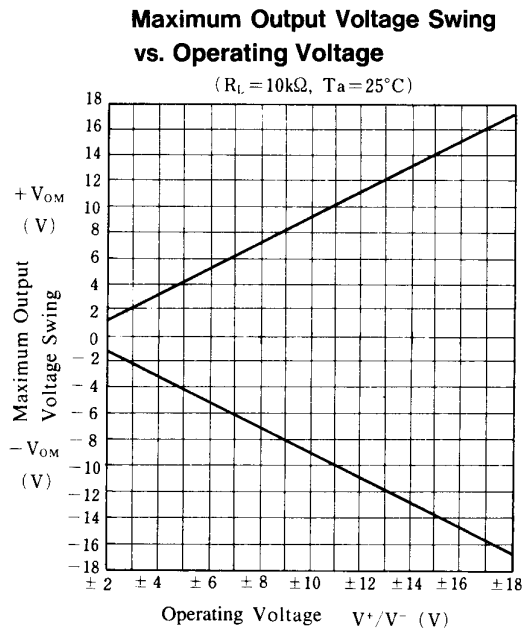
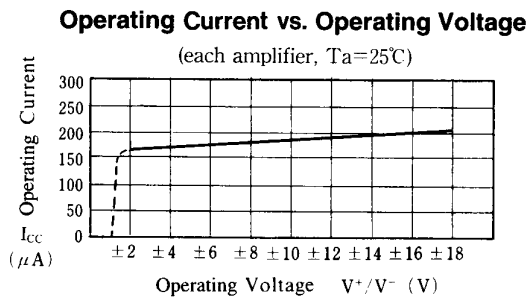
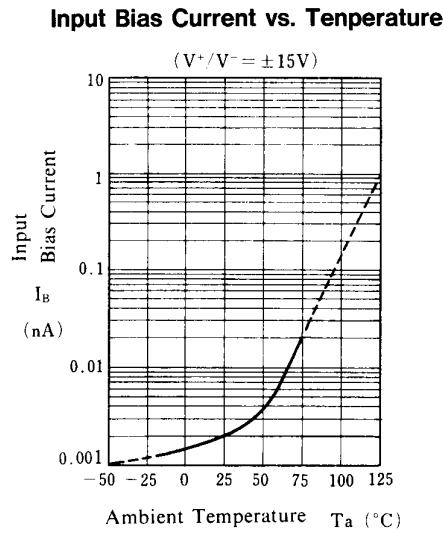
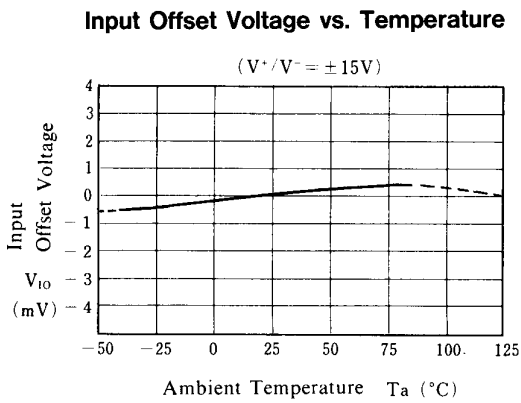
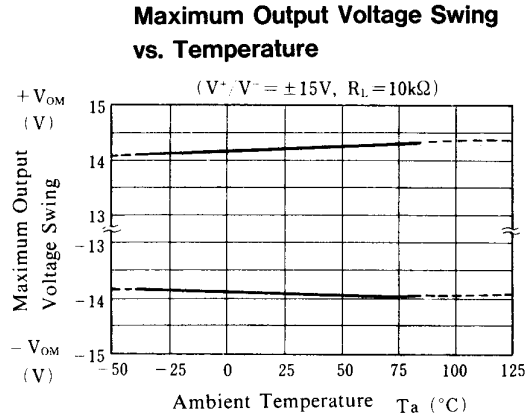
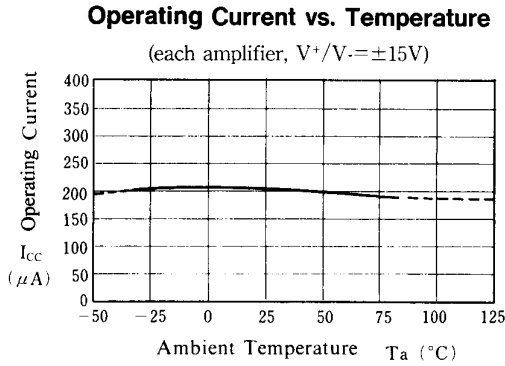

MEMO

[CAUTION]
The specifications on this databook are only given for information, without any guarantee as regards either mistakes or omissions. The application circuits in this databook are described only to show representative usages of the product and not intended for the guarantee or permission of any right including the industrial rights.