

TC9137BP/BF

C-MOS LSI FOR STATIC TYPE DIGITAL TUNING SYSTEM.

TC9137BP/BF are LSI for PLL synthesizer type digital tuning system with PLL circuit and control circuit centralized into one chip.

The static system has been employed at the I/O unit for performance improvement and design simplification.

- PLL circuit and control circuit have been combined into one chip.
- Operating keys, frequency display and various operating displays are all of static type.
- In 2 bands of FM/AM usable throughout the world including Japan, U.S.A. and Europe.
- Simultaneous display of receiving frequency of linear scale type by LED lamp and digital display by a 7-segment display are available.
- Built in LED drivers.
- The preset memories for 6 stations of FM/AM have been stored.
- Prescaler IC TD6104P is of swallow counter type and reference frequency has been set at 25kHz.

MAXIMUM RATINGS (Ta=25°C)

CHARACTERISTIC	SYMBOL	RATING	UNIT
Supply Voltage	V _{DD}	0 ~ 6	V
Input Voltage	V _{IN}	-0.3 ~ V _{DD} +0.3	V
Output Voltage	V _{OUT}	-0.3 ~ V _{DD} +0.3	V
H ₁ ~ H ₅ Output Current	I _{OUT(H)}	30	mA
L ₁ ~ L ₄ Output Current	I _{OUT(L)}	-30	mA
Power Dissipation	PD	800 (300)	mW
Operating Temperature	T _{opr}	-30 ~ 75	°C
Storage Temperature	T _{stg}	-55 ~ 125	°C

Shown in () is rating of TC9137BF.

Unit in mm

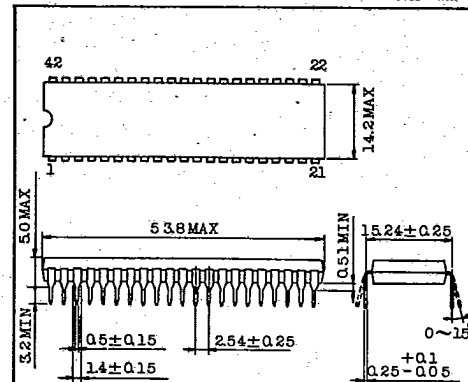

Lead pitch is 2.54 and tolerance is ± 0.25 against theoretical center of each lead that is obtained on the basis of $\frac{1}{16}$ and $\frac{1}{32}$ leads.

JEDEC

TOSHIBA 6D42A-P

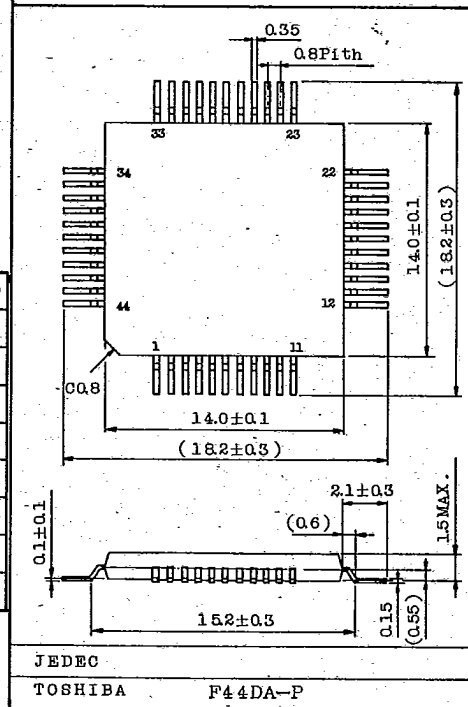

JEDEC

TOSHIBA F44DA-P

TOSHIBA

TC9137BP/BF

T-50-17

PIN CONNECTIONS

TC9137BP

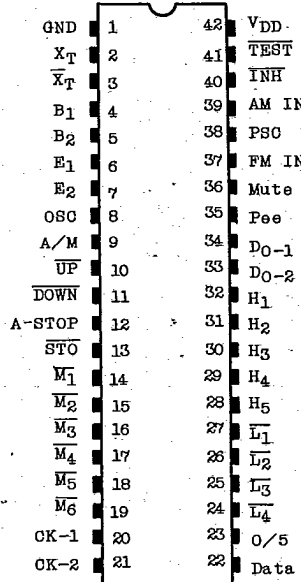

TC9137BF

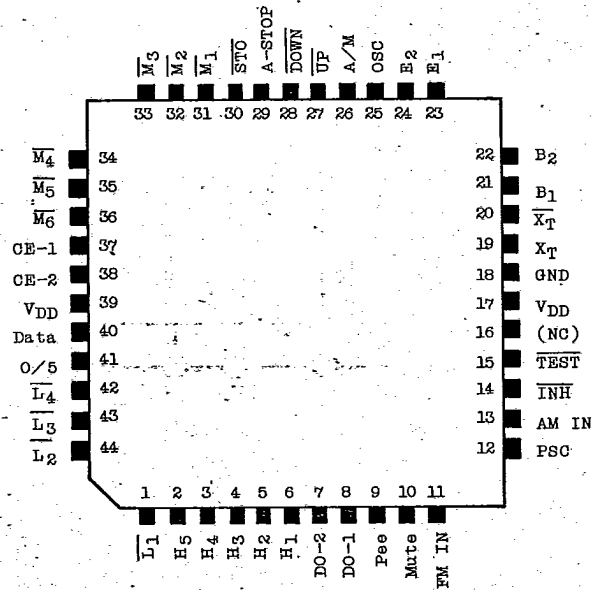

AUDIO DIGITAL IC

TC9137BP/BF

T-50-17

BLOCK DIAGRAM

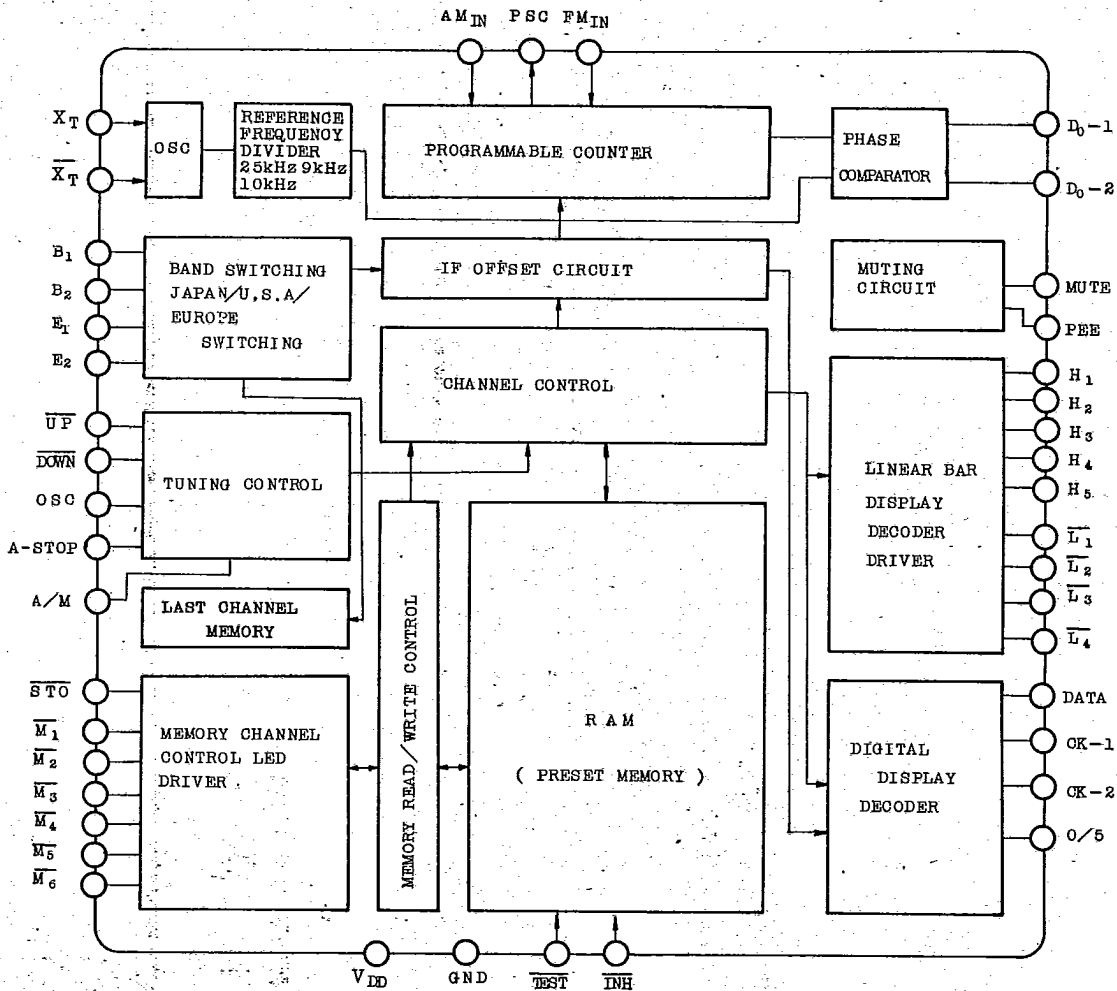

TOSHIBA

TC9137BP/BF

T-50-17

ELECTRICAL CHARACTERISTICS (Unless otherwise specified, $V_{DD}=5.0V$, $T_a=25^{\circ}C$.)

CHARACTERISTIC		SYMBOL	TEST CIRCUIT	TEST CONDITION	MIN	TYP	MAX	UNIT	
Operating Supply Voltage		V_{DD}		-	*4.5	5.0	5.5	V	
Operating Supply Current		I_{DD}		FM Mode $f_{IN}=4.0MHz$	-	3.0	5.0	mA	
Memory Backup Voltage		$V_{DD B}$		-	*2.0	~	5.5	V	
Supply Current at Inhibit		$I_{DD I1}$		$V_{DD}=5V$, $\overline{INH}=0V$	-	-	30	μA	
		$I_{DD I2}$		$V_{DD}=2V$, $\overline{INH}=0V$	-	-	10	μA	
X'tal Oscillation Frequency		$f_{x'tal}$		-	* -	7.2	-	MHz	
FM _{in}	Operating Frequency	f_{FM}		$V_{in}=0.5V_{pp}$	*2.0	~	4.0	MHz	
	Input Amplitude	V_{FM}		$f_{in}=2.0 \sim 4.0 MHz$	*0.5	~	V_{DD}	V_{pp}	
AM _{in}	Operating Frequency	f_{AM}		$V_{in}=0.5 V_{pp}$	*0.9	~	2.1	MHz	
	Input Amplitude	V_{AM}		$f_{in}=0.9 \sim 2.1 MHz$	*0.5	~	V_{DD}	V_{pp}	
PSC	Propagation Delay Time Between FMIN	t_{pd}		$CL=15pF$, $V_{in}=0.5V_{pp}$	* -	-	200	nSec	
	Maximum Load Capacity	C_L		-	* -	-	15	pF	
Output Terminal Current	H ₂ H ₅	Output Current "H"Level	$I_{OH H}$	$V_{OH} = 4.0V$	15	20	-	mA	
		Leak Current at OFF	$I_L H$	$V_{OH} = 0 V$	-	-	1.0	μA	
	L ₁ L ₄	Output Current "L"Level	$I_{OL L}$	$V_{OL} = 1.5V$	15	20	-	mA	
		Leak Current at OFF	$I_L L$	$V_{OL} = 5.0V$	-	-	1.0	μA	
	M ₁ M ₆ STO O/S	Output Current "L"Level	$I_{OL M}$	$V_{OL} = 2.0V$	15	20	-	mA	
		Leak Current at OFF	$I_L M$	$V_{OL} = 5.0V$	-	-	1.0	μA	
	DO ₁ DO ₂ PSC	Output Current	"H"Level	I_{OHDO}	$V_{OH} = 3.5V$	0.6	1.0	-	mA
			"L"Level	I_{OLD0}	$V_{OL} = 1.5V$	0.6	1.0	-	mA
		Leak Current at OFF	$I_L DO$	-	-	-	0.1	μA	
	Mut Pee Data CK 1 CK 2	Output Current	"H"Level	$I_{OH P}$	$V_{OH} = 3.5V$	1.0	3.0	-	mA
"L"Level			$I_{OL P}$	$V_{OL} = 1.5V$	1.0	3.0	-	mA	
Output Terminal	INH TEST	Input Voltage	"H"Level	$V_{IH 1}$	-	4.0	~	V_{DD}	V
			"L"Level	$V_{IL 1}$	-	0	~	3.0	V
	Other All Inputs	Input Voltage	"H"Level	$V_{IH 2}$	-	3.5	~	V_{DD}	V
			"L"Level	$V_{IL 2}$	-	0	~	1.5	V
	Input Leak Current		$I_{IL K}$		-	-	-	10	μA
Input Pull-up Resistance		R_{up}		-	120	330	750	k Ω	

Note 1: The items marked with asterisks guarantee all the conditions of $V_{DD} = 4.5 \sim 5.5(V)$ and $T_a = -30 \sim +75(^{\circ}C)$.

AUDIO DIGITAL IC

TC9137BP/BF

T-50-17

FUNCTIONAL EXPLANATION OF EACH TERMINAL Those shown in () are terminal No.s of TC9137BF

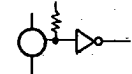
NO.	SYMBOL	FUNCTIONAL EXPLANATION	REMARKS															
2,3 (19,20)	X _T $\overline{X_T}$	Reference frequency crystal oscillator connecting terminals. X'tal 7.2 MHz Oscillation is stopped at time of $\overline{INH=L}$	With a built-in feedback resistor															
4,5 (21,22)	B ₁ B ₂	FM/AM band selector input and FM IF fine adjustment and selector input. <table border="1" style="margin-left: auto; margin-right: auto;"> <thead> <tr> <th>B₁</th> <th>B₂</th> <th></th> </tr> </thead> <tbody> <tr> <td>0</td> <td>0</td> <td>A M</td> </tr> <tr> <td>1</td> <td>0</td> <td>FM (10.7 MHz - 50 K)</td> </tr> <tr> <td>0</td> <td>1</td> <td>FM (10.7 MHz + 50 K)</td> </tr> <tr> <td>1</td> <td>1</td> <td>FM (10.7 MHz)</td> </tr> </tbody> </table>	B ₁	B ₂		0	0	A M	1	0	FM (10.7 MHz - 50 K)	0	1	FM (10.7 MHz + 50 K)	1	1	FM (10.7 MHz)	* A lock switch used.
B ₁	B ₂																	
0	0	A M																
1	0	FM (10.7 MHz - 50 K)																
0	1	FM (10.7 MHz + 50 K)																
1	1	FM (10.7 MHz)																
6,7 (23,24)	E ₁ E ₂	Destination selector input for Japan, U.S.A. and Europe <table border="1" style="margin-left: auto; margin-right: auto;"> <thead> <tr> <th>E₁</th> <th>E₂</th> <th>Mode</th> </tr> </thead> <tbody> <tr> <td>0</td> <td>0</td> <td>-</td> </tr> <tr> <td>1</td> <td>0</td> <td>Japan</td> </tr> <tr> <td>0</td> <td>1</td> <td>U.S.A.</td> </tr> <tr> <td>1</td> <td>1</td> <td>Europe</td> </tr> </tbody> </table>	E ₁	E ₂	Mode	0	0	-	1	0	Japan	0	1	U.S.A.	1	1	Europe	Setting is wired from a back-up power supply. * When $\overline{INH} = L$ and FM and AM are changed over, E ₁ and E ₂ inputs are read and latched.
E ₁	E ₂	Mode																
0	0	-																
1	0	Japan																
0	1	U.S.A.																
1	1	Europe																
8 (25)	OSC	Connecting terminal for C and R of an oscillator that decides auto search speed. Store auto release of the preset memory and shift time to fast forward at time of manual channel selection are also decided by this oscillation frequency.																
9 (26)	A/M	Input for changing UP/DOWN turning mode from manual to auto search action. "H" Input Auto Search "L" Input Manual	* A lock switch used. 															

TOSHIBA

TC9137BP/BF

T-50-17

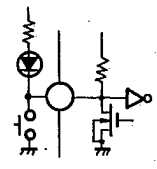
NO.	SYMBOL	FUNCTIONAL EXPLANATION	REMARKS
10,11 (27,28)	$\overline{\text{UP}}$ $\overline{\text{DOWN}}$	<p>Tuning key input.</p> <ul style="list-style-type: none"> o Manual: When the key is kept pushed for more than 0.3 sec. at the step forwarding of 1 step/push, it becomes fast forwarding, and when the key is released, the turning is stopped and all channels on the way are passed. o Auto Search: When the key is pushed the auto search is started to select a channel and then, stopped automatically. <p>With a built-in pull-up resistor.</p>	<p>* When the band edge is reached during the fast forward, the tuning is stopped.</p> <p>* Scan waveform is a triangular wave shape.</p> 
12 (29)	A-STOP	<p>Auto search stop input.</p> <p>When "H" level signal is applied to this terminal during the auto search, the scan is stopped.</p>	
13 (30)	$\overline{\text{STO}}$	<p>Preset memory store input. I/O terminal with a built-in LED driver.</p> <ul style="list-style-type: none"> o When STO key is pushed, STO lamp illuminates, when a desired Memory No. key is then pushed, receiving frequency data is written into that memory and STO lamp goes out. o If a Memory No. key is not pushed even when STO key is pushed, STO key is automatically released. 	<p>* With a built-in LED driver</p> 
14~19 (31~36)	$\overline{\text{M}}_1 \sim \overline{\text{M}}_6$	<p>Memory address assignment input. Terminal with a built-in LED driver.</p> <ul style="list-style-type: none"> o At FM or AM receiving, $\overline{\text{M}}_1 \sim \overline{\text{M}}_6$ are used for assigning FM/AM memory address. o To write push STO key and $\overline{\text{M}}_1 \sim \overline{\text{M}}_6$ keys of a desired channel. o To read push $\overline{\text{M}}_1 \sim \overline{\text{M}}_6$ keys of a desired channel. 	<p>* With a built-in LED driver</p> <p>* Same as STO</p>

AUDIO DIGITAL IC

TC9137BP/BF

T-50-17

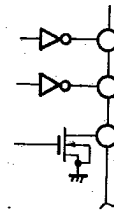
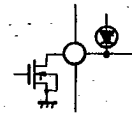
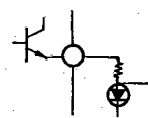
NO.	SYMBOL	FUNCTIONAL EXPLANATION	REMARKS
20~23 (37, 38, 40)	CK-1, CK-2, Data, 0/5	<p>Receiving frequency digital display data and timing signal output terminals.</p> <p>When power is ON, receiving frequency digital display data and timing signal are transmitted by 1 cycle only when frequency is updated, e.g., UP/DOWN key operation, auto scan, memory read, FM/AM change-over, etc. Under normal receiving state, they are fixed at "L" level.</p> <ul style="list-style-type: none"> o Data Frequency binary code data and receiving band. o CK-1, CK-2 Initialize and transfer clock. o 0/5 For 50 kHz display at time of FM in Europe. 	 <p>* 0/5 Terminal Data 0: Open Data 5: "L"</p>
24~27 (42~44, 1)	$\overline{L_1} \sim \overline{L_4}$	<p>Receiving frequency linear scale display LED drive output.</p> <p>LED is driven by $H_1 \sim H_5$ and push-pull.</p> <p>As outputs from these terminals are binary 3 bits, use of a decoder becomes necessary.</p> <p>Frequency linear scale display of max. 18 spots is possible by the matrix of decoder outputs $L_1 \sim L_4$ and $H_1 \sim H_5$.</p>	 <p>With a built-in Nch open drain driver</p>
28~32 (2~6)	$H_1 \sim H_5$	<p>Receiving frequency linear scale display LED drive output.</p> <p>Frequency linear scale display of max. 18 spots is possible by the matrix of $\overline{L_1} \sim \overline{L_4}$ decoder outputs.</p>	 <p>With a built-in NPN transistor.</p>

TOSHIBA

TC9137BP/BF

T-50-17

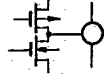
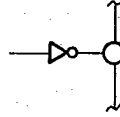
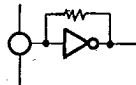
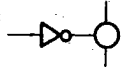
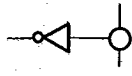
NO.	SYMBOL	FUNCTIONAL EXPLANATION	REMARKS
33,34 (7,8)	D ₀₋₁ D ₀₋₂	Phase comparator output. Same outputs are parallelly transmitted at D ₀₋₁ and D ₀₋₂ and can be used exclusively for FM and AM.	
35 (9)	Pee	Key operation validation pee sound generating output.	
36 (10)	Mute	Muting output. This terminal is normally kept at "L" level, and is changed to "H" level at time of muting.	
37 (11)	FM _{IN}	FM programmable counter input. The input has a built-in amplifier.	 *1
38 (12)	PSC	Control output for the swallow counter type Prescaller TD6104P.	
39 (13)	AM _{IN}	AM programmable counter input. The input has a built-in amplifier.	Same as *1.
40 (14)	$\overline{\text{INH}}$	Inhibit input. Normal operation at "H" level. Inhibit operation at "L" level.	
41 (15)	$\overline{\text{TEST}}$	Initialize input. Normal operation at "H" level. Initialize operation at "L" level.	
1,42 (17,18,39)	GND, VDD	Supply voltage applying terminal 5V ± 0.5V	

AUDIO DIGITAL IC

TC9137BP/BF

T-50-17

DESCRIPTION OF OPERATION

PLL UNIT

1. REFERENCE FREQUENCY

Reference frequency divides oscillation frequency from the crystal oscillator into 25 kHz at time of FM and 9 kHz/10 kHz at time of AM.

As the crystal oscillator has a built-in self-bias amplifier by means of C-MOS inverter, it can be easily configured simply by connecting a crystal and condenser as illustrated below.

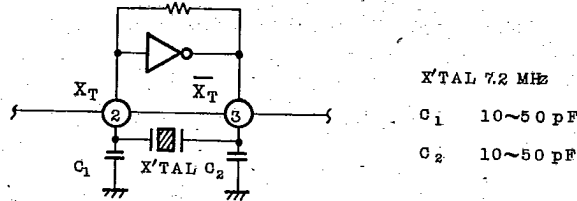

The divider divides 7.2 MHz oscillation frequency from the crystal oscillator at a dividing ratio of 288 at time of FM, 800 at AM (9 kHz) and 720 at AM (10 kHz), respectively and input then into the phase comparator.

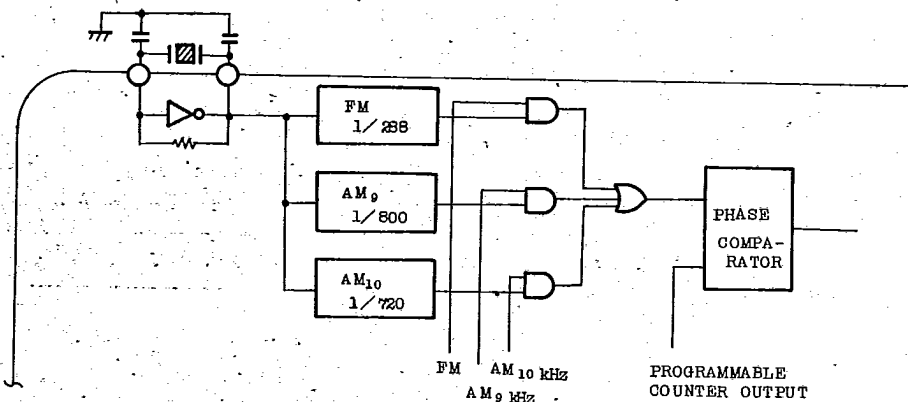

TOSHIBA

TC9137BP/BF

T-50-17

MODE	DIVIDING RATIO	REFERENCE FREQUENCY
FM	288	25 kHz
AMJ/E	800	9 kHz
AMU	720	10 kHz

2. PROGRAMMABLE COUNTER

TC9137BP/BF employs the so-called swallow count type counter which using 2 sets of programmable counter selectively.

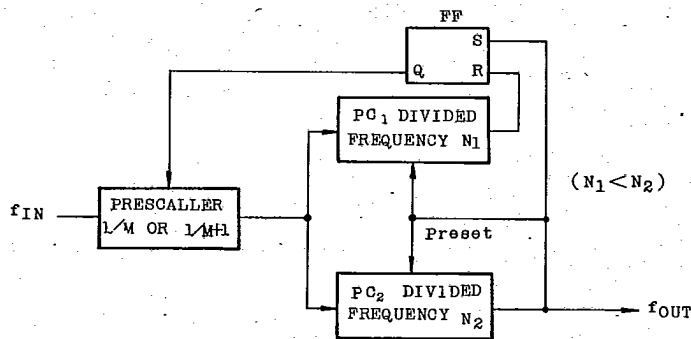

Relation between f_{in} and f_{out} in this system is as follows:

$$f_{in} = \{ (M + 1) N_1 + M(N_2 - N_1) \} f_{out}$$

$$= (MN_2 + N_1) f_{out}$$

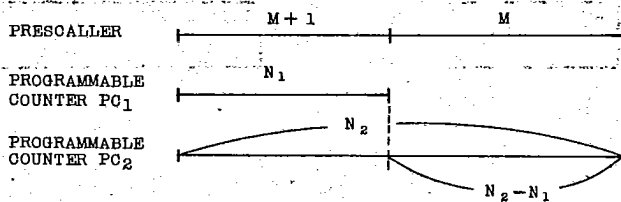

AUDIO DIGITAL IC

TC9137BP/BF

T-50-17

At divided frequency $M+1$ of the prescaler, both PC_1 and PC_2 simultaneously start to count and when PC_1 becomes N_1 , the divided frequency of the prescaler is changed over to M as $N_1 < N_2$. When PC_2 counted remaining $N_2 - N_1$, the prescaler is again switched to M and divided data (N_1 and N_2) are preset at PC_1 and PC_2 and the counter is returned to the initial state.

In this case, as switching signals $1/M$ and $1/M+1$ must be transmitted within one cycle of input frequency, rerouting of wires shall be avoided to the extent possible.

As f_{MAX} OF TC9137P is 4 MHz, transmission delay time of this switching signal has the following limitation:

$$TD < 250 \text{ nsec}$$

2-1) FM Programmable Counter

Different programmable counters are used for FM and AM. For FM, the above-mentioned swallow count type programmable counter is used.

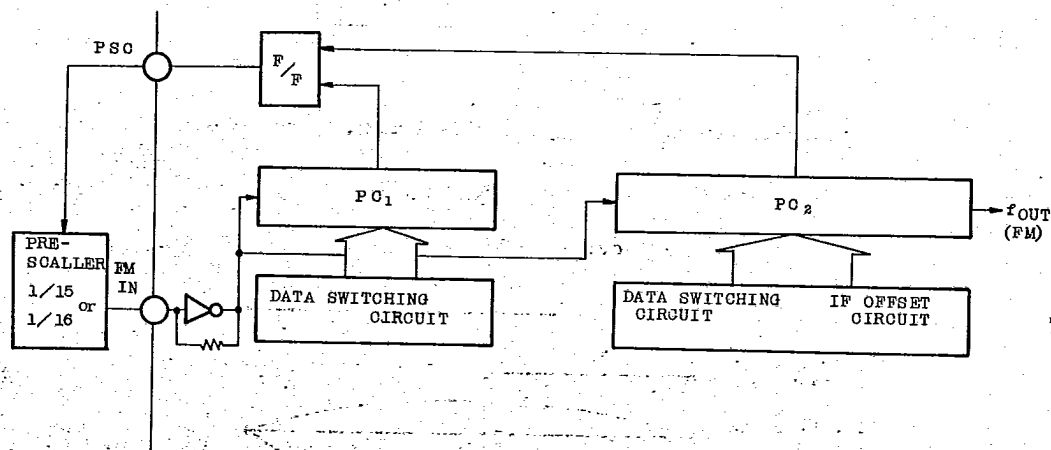

TOSHIBA

Divided frequency of the programmable counter is set at the data switching circuit. Off-set of IF frequency is added to the divided frequency and preset at this time.

2-2) AM Programmable Counter

At time of AM, PC₂ only is used as no swallow count type counter is used and a direct division system is used.

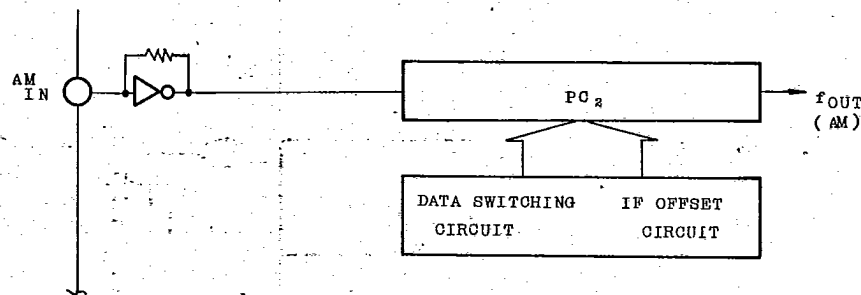

As in FM, the divided frequency is preset with off-set of IF frequency added.

3. PHASE COMPARATOR

The phase comparator compares phase of reference frequency and that of output from the programmable counter and controls VCO through the low-pass filter so that frequencies and phases of two signals come to agree each other.

DO-1, DO-2 Outputs

- a) When phase of divided output from the programmable counter is behind that of reference frequency, N_{ch} FET is turned ON and DO-1 and DO-2 output become "L" Level for the duration equivalent to that phase difference.

TC9137BP/BF

T-50-17

- b) On the other hand, when phase of divided output from the programmable counter is ahead of that of reference frequency, Pch FET is turned ON and DO-1 and DO-2 outputs become "H" level.
- c) During the period other than above, DO-1 and DO-2 outputs are kept in high impedance state with both Nch and Pch turned OFF.

As the phase comparator has two tri state outputs of DO-1 and DO-2, two sets of low-pass filters can be used without switching and it is possible to set their constants at optimum values in both FM and AM bands.

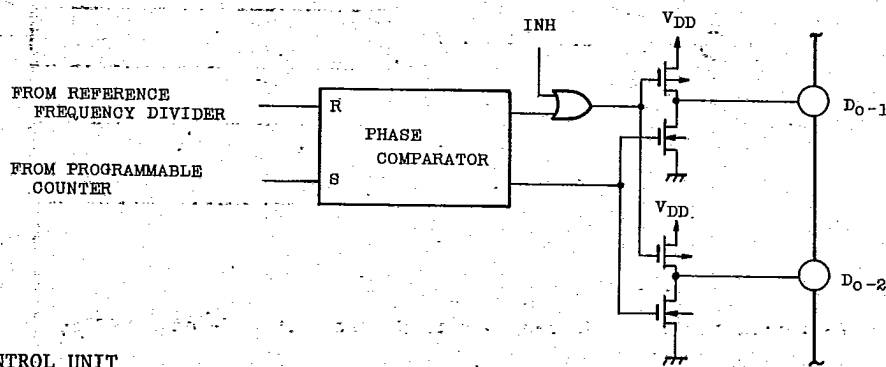

CONTROL UNIT

FUNCTIONAL DESCRIPTION

1. TC9137BP/BF CAN CONTROL THE RECEPTION OF 6 BANDS IN THE FOLLOWING TABLE.

BAND	RECEIVING FREQ. BAND	INTERMEDIATE FREQUENCY	FREQUENCY STEP	REMARKS
FMJ	87.5 ~ 108.0MHz	+10.7MHz	100kHz	FM U.S.A. band
FME	87.5 ~ 108.0MHz		50kHz	FM Europe band
FMJ	76.0 ~ 90.0MHz	-10.7MHz	100kHz	FM Japan band
AMJ	520 ~ 1610kHz	+450kHz	10kHz	AM U.S.A. band
AME	522 ~ 1602kHz		9kHz	AM Europe band
AMJ	522 ~ 1629kHz		9kHz	AM Japan band

* Shifting of IF frequency (± 50 kHz) at time of FM is possible.

2. THE CONTROL UNIT HAS A VARIETY OF CHANNEL SELECTING FUNCTIONS.

- 1) 1 step/push manual tuning by UP and DOWN keys.

TOSHIBA



TC9137BP/BF

T-50-17

- 2) Manual fast forward tuning by continuous depressing of UP and DOWN keys.
 - 3) Auto search tuning by Auto and UP or DOWN keys.
 - 4) Preset tuning by memory read.
3. MEMORIES AND SUBMEMORIES
- 1) The memories for 12 channels are allocated by 6 channels for AM and FM, respectively.
 - 2) Write into the memory is accomplished easily by 2 pushes of STO key and Memory No. key. Read-out is accomplished by one push of Memory No. key.
 - 3) All memories are composed of static type C-MOS RAM, realizing low-voltage and low power consumption.
 - 4) In addition to the memories for 12 channels, the last frequency memories for FM and AM are available.
4. DISPLAY FUNCTION
- 1) All displays are of static type.
 - 2) The receiving frequency display is of linear scale type and has a built-in LED driver. Further, when the digital display driver TD6301AP, TC9158/59P is connected, both the linear scale and digital display can be simultaneously made.
5. OTHERS
- 1) Scan speed at time of auto search operation can be adjusted corresponding to the set design with the externally installed C.R of the oscillator terminal.

AUDIO DIGITAL IC

TC9137BP/BF

- 2) Because of the control terminal $\overline{\text{INH}}$ which stops all outputs when the set power supply is OFF and makes the operation of LSI including oscillation of the oscillator completely static, it is possible to back up receiving state including memory contents with minimum power available from a battery or condenser for extended period of time.

DESCRIPTION OF OPERATION

1. DECISION OF OSC FREQUENCY

OSC terminal is a single terminal type oscillator CR connecting terminal and scan speed during auto search, automatic release of store state, and continuous pressing time for manual fast forward are all decided by frequency from this terminal.

Oscillation frequency $f_{\text{OSC}} \div 1.2 C_X, R_X$ (Hz)

- (a) Scan speed (Auto search, Manual F. FWD)

$$f_{\text{OSC}}/2 \text{ (step/sec)}$$

- (b) UP/DOWN key continuous pressing time till time F. FWD

$$14/f_{\text{OSC}} \text{ (sec)}$$

- (c) STO key pressing time till automatic release

$$224/f_{\text{OSC}} \text{ (sec)}$$

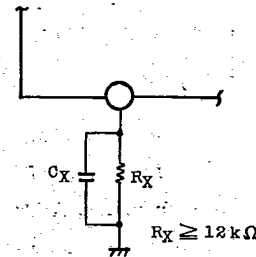

During the inhibit state, oscillation of OSC is stopped in order to reduce current consumption.

- (Note) As voltage between IC's and supply voltage may considerably fluctuate, for oscillation frequency refer to a graph (1) which is described later.



TC9137BP/BF

T-50-17

2. METHOD FOR SELECTING RECEIVING BANDS

As mentioned above, a total of 6 kinds of bands of FM_U, FM_E, FM_J, AM_U, AM_E and AM_J can be selectively used on TC9137BP/BF, the definite method for selecting receiving bands is explained in the following.

2-1) FM and AM Selection

Selection of FM and AM is decided by specifying state of two input B₁ and B₂. FM selection also includes IF shifting.

B ₁	B ₂	BAND	VCO FREQUENCY	IF FREQUENCY
0	0	A M	Normal	450 kHz
1	0	F M	-50 kHz	U.S.A, Europe: 10.65 MHz Japan: 10.75 MHz
0	1		+50 kHz	U.S.A, Europe: 10.75 MHz Japan: 10.75 MHz
1	1		Normal	10.7 MHz

When IF of FM is used at 10.7 MHz, B₁ and B₂ can be used by short-circuiting them externally.

2-2) Selection of Destination of Japan, U.S.A and Europe

When FM or AM is selected in 2-1), above, 2 input lines of E₁ and E₂ are used for assignment of destination under respective modes.

E ₁	E ₂	DESTINATION
0	0	Unusable
1	0	Band for Japan
0	1	Band for U.S.A.
1	1	Band for Europe

* Switching of assignment of destination is read in when TEST terminal is at "L" level, at time of FM/AM switching, and $\overline{\text{INH}}$ is at "L" level.

AUDIO DIGITAL IC

TC9137BP/BF

T-50-17

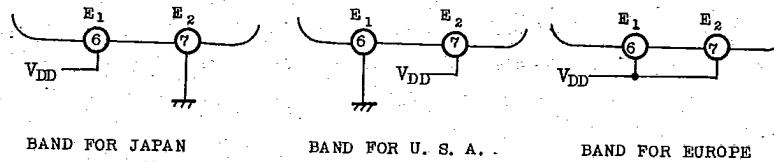

3. METHOD FOR CHANNEL SELECTION

Although there are various channel selecting methods for TC9137P, basically the channel selection is accomplished by total 3 input lines of Auto/Manual switching input A/M terminal, and UP/DOWN selection UP terminal and DOWN terminal. For Auto/Manual switching the lock switch is used, while a non-lock switch is used for UP/DOWN selection.

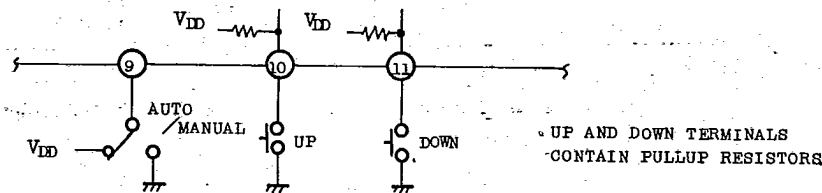

In the following respective tuning methods are described.

3-1) 1 Step/1 Push Tuning

When UP or DOWN key is depressed by one push for a short time when A/M terminal is under manual state ("L" level), receiving frequency is up or down at 100 kHz for FM_U and FM_J, 50 kHz for FM_E, 9 kHz for AM_E, AM_J and 10kHz for AM_U, respectively.

TOSHIBA

When frequency up is continuously assigned and the upper band edge is reached, the set does not operate thereafter even when UP or DOWN key is pushed. In the similar manner, frequency DOWN is stopped to shift at the lower band edge.

UP/DOWN terminals have a chattering prevention circuit but processing time is set at a short time and therefore, it is possible to cope with a certain speed rotary switch.

3-2) Manual FAST Tuning

When UP or DOWN key is continuously pushed for a fixed time T_1 under manual state as in 3-1), receiving frequency is up or down at fast forward mode and when the key is released, the fast forward is stopped. T_1 and fast scan speed are decided by the above-mentioned oscillation frequency from OSC. When this oscillation frequency is assumed to be f_{OSC} (Hz),

$$T_1 = \frac{14}{f_{OSC}} \text{ (sec)} \quad \text{and fast speed} = \frac{f_{OSC}}{2} \text{ (Step/sec)}$$

Fast tuning may be illustrated as shown below:

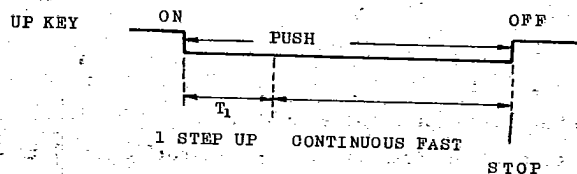

As in 1 step tuning described in 3-1), when this continuous fast tuning stops scan when the band edge is reached.

3-3) Auto Search Tuning

The auto search tuning is a large merit in the synthesizing of a tuner, and various consideration have been made on TC9137BP/BF to make the most of this function.

TC9137BP/BF

T-50-17

- (a) Scan speed - Faster scan speed is preferable to user. Particular in case of FM, there are many channels because of 50 kHz channel space and scan speed is an important matter. However, scan speed is limited by the lock-up time of PLL system or time constant for receiving signal level detection from the viewpoint of the set designing, and scan speed can not be easily decided.

Therefore, TC9137BP/BF has been so designed that the scan speed can be externally adjusted. As mentioned in the foregoing, it is possible to optionally control scan speed by oscillation frequency from OSC.

- (b) Misstop - In the auto search tuning, the receiver automatically scan to detect a desired channel and the auto search tuning is stopped. However, extremely severe characteristics are demanded in generating auto stop signal. If auto stop signal is not properly generated, the auto search tuning may not stop at a frequency transmitting from a broadcasting station but may stop before or after that frequency.

- (c) Separation from a current receiving station - Let's assume that a broadcasting is now receiving. When it is desired to start the auto search turning newly, it may be difficult to separate from the currently receiving station in some cases as the auto stop signal is continuously in effect.

To solve this problem, on TC9137BP/BF the auto stop signal (A-STOP Terminal) is read by the last one pulse only at the scan time. Thus, it becomes possible to give a margin to a time constant of the auto stop signal, and the designing becomes easy.

TOSHIBA

TC9137BP/BF

T-50-17

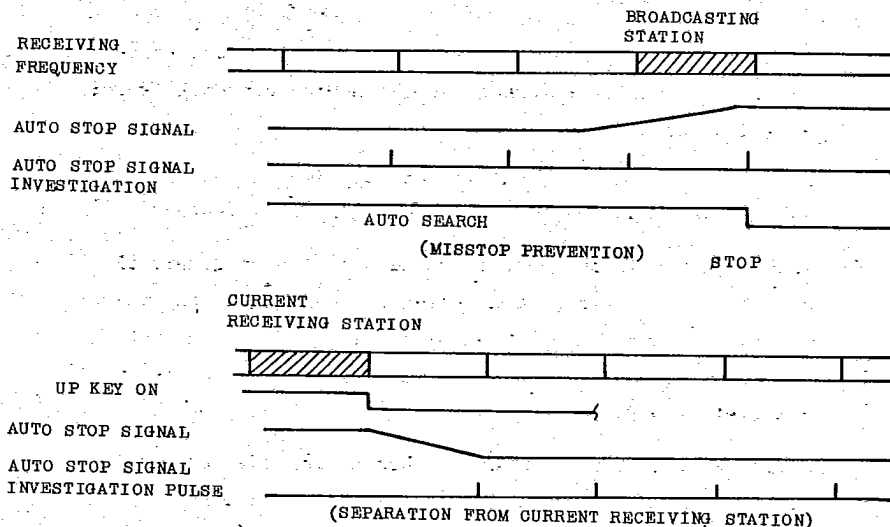

Method for Auto Search Tuning

To start the auto search tuning, first place A/M terminal in auto search state ("H" level). Then, place UP terminal in "L" level to make the scan toward higher frequency and DOWN terminal in "L" level to make the scan toward lower frequency.

In this case, immediately after UP or DOWN key is pushed the scan started and does not stop even when the key is released. When the band edge is reached, the scan is continuously carried out till "H" level is input to A-STOP terminal (when there is a broadcasting station).

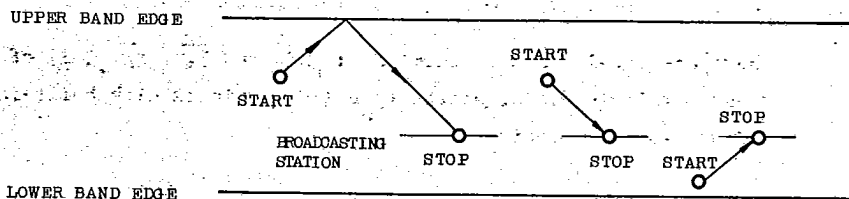

The scan waveform of auto search tuning is shaped like a triangle wave.

TC9137BP/BF

(Note)

- 1) If the memory read out is carried out during the auto search, the auto search is released and the memory contents are displayed as usual.
- 2) Even when "H" level signal is kept applied at A-STOP terminal during receiving, the auto search tuning will start.
- 3) When DOWN key is pushed during the auto search toward UP direction, the auto search tuning is switched at the moment toward DOWN direction. When UP key is pushed from DOWN direction, the direction of the auto search tuning is similarly reversed.
- 4) While UP or DOWN key is kept pushed during the auto search tuning, the auto stop signal is disregarded and the scan is continuously carried out.

4. MEMORY FUNCTION

That optional frequency data is stored always and a desired channel can be selected by one touch is the largest feature of the synthesizer tuner.

TC9137BP/BF has a built-in memory for total 12 channels including 6 FM and 6 AM channels. As this memory is the static RAM in C-MOS structure, low voltage and low power consuming operation is possible and can be easily backed up by a battery or condenser.

4-1) Memory Key Connection Method

There are total 7 memory terminals: \overline{STO} and $\overline{M_1} \sim \overline{M_6}$. All of these terminals are of static type I/O terminals with built-in status display drivers.

TC9137BP/BF

T-50-17

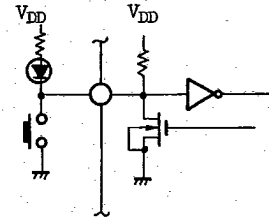

4-2) Method for Memory Write

- 1) Memory write is carried out by key operation of two times.
First, when STO key is pushed, the memory write display LED lamp illuminates. Then, when a desired memory address is assigned from $M_1 \sim M_6$ terminals, receiving frequency data at that time is stored in the memory.

If AM is receiving at this time, AM data is stored, and if FM is receiving, FM data is stored in the memory.

- 2) Immediately after STO key is pushed, the memory is set at the ready-to-write state, but this state is automatically released after a certain time unless a desired Memory No. key is pushed and LED lamp goes out. This time is decided by oscillation frequency of OSC, and assuming that this frequency is f_{OSC} ,

$$T = 224/f_{OSC} (\approx 10 \text{ sec})$$

This automatic release function is to prevent erroneous erase of already written memory contents when STO key is operated.

For instance, in selecting 82.5 MHz by the tuning and writing this frequency into No. 3 memory, when STO key is first pushed, the store lamp illuminates. When M_3 key is then pushed, the store lamp goes out and Memory 3 lamp illuminates.

AUDIO DIGITAL IC

4-3) Method of Memory Read

Under any operating condition, the memory readout can be carried out by simply pushing a desired Memory No. key.

For instance, if it is desired to select Memory No. 5 channel, push M₅ key. The Memory 5 lamp illuminates in a moment and the frequency display changes to the contents of Memory 5 and receiving is carried out.

At time the power is turned ON, it is not know what contents are stored in the memory.

When the memory is read out under such a state as this, frequency data out of the receiving band may possibly come out. To prevent this, TC9137BP/BF is provided with the band edge detection function and if data is out of the band, the receiving band is corrected by force to a lower band edge.

4-4) Last Frequency Memory

For instance, lets assume that the receiving mode is changed to FM mode during AM 1100 kHz is receiving. At this time, data of 1100 has a meaning of 110.0 MHz in FM. This frequency is outside FM band and is brought back to the band edge.

To solve this trouble, TC9137BP/BF has a built-in last frequency memory.

The last frequency memory is a sub-memory to store data existing prior to the switching of FM/AM at time of the switching.

Write to the memory is automatically carried out without requiring any operation.

TC9137BP/BF

T-50-17

That is, when 1100 kHz is currently stored in the sub-memory and the receiving mode is switched from FM 80.0 MHz to AM, the receiving frequency becomes 1100 kHz and the contents of the sub-memory becomes 80.0 MHz. Further, after the receiving of 1250 kHz by operating UP key under AM mode and AM mode is again switched to FM mode, the receiving frequency becomes 80.0 MHz automatically and AM 1250 kHz is written into the sub-memory.

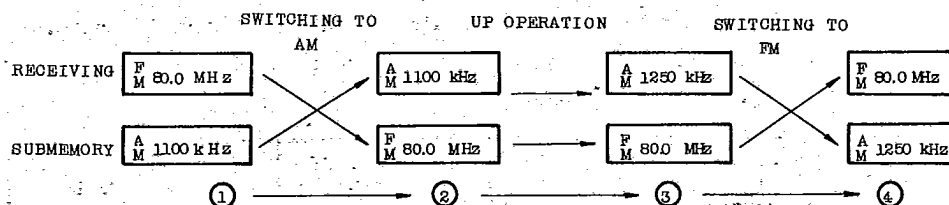

5. DISPLAY OF RECEIVING FREQUENCY

On TC9137BP/BF, the linear scale display of receiving frequency in which the traditional pointer display image is taken as well as the digital display are possible.

As the result, the following disadvantages involved so far in the digital display can be solved by the combined use of the digital display and the linear scale display:

- 1) Location of receiving frequency in a band is hard to sense.
- 2) Operation at time of UP/DOWN is hard to catch.

Further, the linear scale display only will provide the following merits:

- 1) It is possible to realize a low cost set by selecting number of dots.

AUDIO DIGITAL IC

TC9137BP/BF

T-50-17

- 2) The digital display requires several hundred mA for LED. However, several mA 10 and several mA are sufficient for LED illumination as only one point requires to be illuminated, thus making it possible to apply the linear scale display to a portable set.

5-1) Number of Linear Scale Dots

TC9137BP/BF is capable of linear scale displaying of Max. 16 spots. Number of dots per band and number of channels per dot are as shown in the following table.

BAND NAME	RECEIVING BAND	CHANNEL STEP	NO. OF CHANNELS	CHANNEL /DOT	TOTAL NO. OF DOTS
FMU	87.5 ~ 108.0MHz	100kHz	201	16	13
FME	87.5 ~ 108.0MHz	50kHz	411	32	13
FMJ	76.0 ~ 90.0MHz	100kHz	141	8	18
AMU	520 ~ 1610kHz	10kHz	110	8	14
AME	522 ~ 1602kHz	9kHz	121	8	16
AMJ	522 ~ 1629kHz		124	8	16

(Note) The lamps illuminate equally at the low band edge, but there are differences at the upper band edge depending upon band.

5-2) Method for LED Connection

LED is of a static lighting by means of matrix system through (by use of) $H_1 \sim H_5$ and $\bar{L}_1 \sim \bar{L}_4$. $H_1 \sim H_5$ output contains NPN transistor open emitter and $\bar{L}_1 \sim \bar{L}_4$ does N^{ch} FET open drain type; therefore, no external transistor is required.

TOSHIBA

TC9137BP/BF

T-50-17

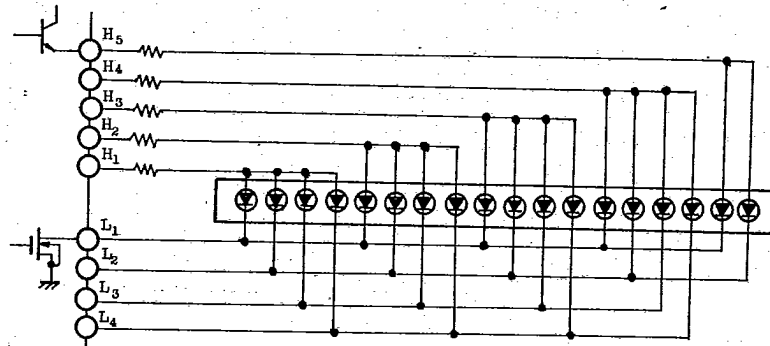

5-3) Digital Display

The receiving frequency display of TC9137BP/BF is basically the linear scale display as described above. However, it is the feature of TC9137BP/BF that the digital display is also possible when the static frequency display driver TD6301AP is added. Therefore, TC9137BP/BF has the receiving frequency data and timing signal output terminals required for TD6301AP for display.

The outputs are total 3; Data terminal for receiving frequency data, timing signal CK-1 and CK-2 terminals. Outputs are transmitted by one cycle only at the following timings only when receiving frequency is updated.

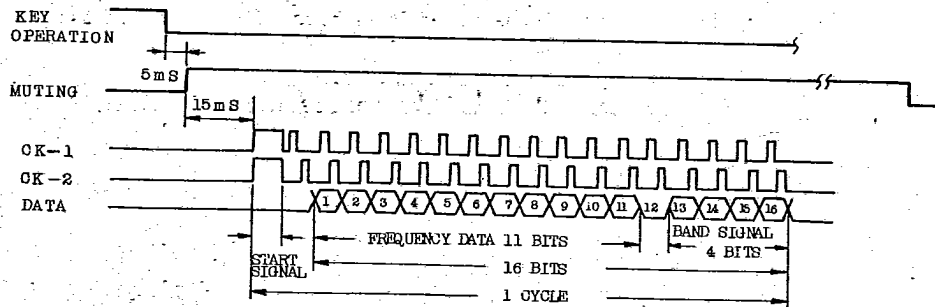

AUDIO DIGITAL IC

TC9137BP/BF

a. Data Signal (Data)

Data signal is composed of 16 bits of which 1 ~ 11 bits are allocated to receiving frequency data and 13 ~ 16 bits to kinds of receiving bands.

Frequency data

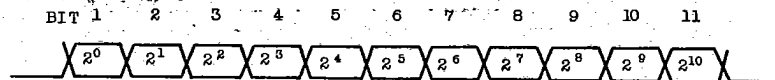

Frequency data is a value of receiving frequency minus the lower band edge of that band.

For instance, in case of 1210 kHz data in AM_U band, the lower band edge of AM_U is 520 kHz and therefore, the frequency data in this case is,

$$\begin{aligned} & 1210 \text{ (Receiving Frequency)} - 520 \text{ (Lower Band Edge)} \\ & = 690 \text{ (Frequency Data)} \end{aligned}$$

This frequency data of 690 is serially transmitted in binary code ranging from 1 bit to 11 bits in above table.

Band Signal

TC9137BP/BF has a total 6 bands; 3 FM bands (FM_E/FM_U/FM_J) and 3 AM bands (AM_E/AM_U/AM_J). However, as FM_E and FM_U, AM_E and AM_J are in the same lower band edge respectively, net number of bands is 4 bands.

State of these 4 bands is assigned by 4 bits of data signal bit 13 ~ 16.

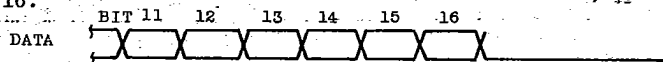

bit	13	14	15	16	Band
1	0	0	0	0	FM _J
0	1	0	0	0	FM _U /FM _E
0	0	1	0	0	AM _J /AM _E
0	0	0	1	1	AM _U

TC9137BP/BF

T-50-17

b. Timing Signals (CK-1, CK-2):

CK-1 and CK-2 are transmitted at the following timings as data signal read timing signals. These timing signals are used in data read, latch and operation of the static frequency display driver TD6301AP.

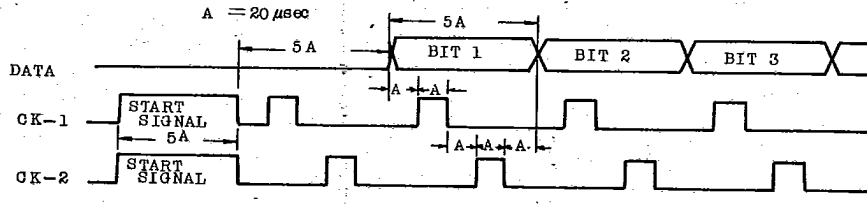

c. Examples of Output Waveforms

Data at time of AM_J band 1251 kHz is

$$1251 - 522 = 729 \rightarrow 10011011010$$

and its waveform is as shown below:

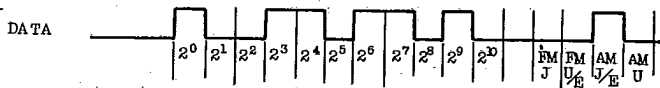

Data at time of FM_U band 107.0 MHz is

$$1070 - 875 = 195 \rightarrow 11000011000$$

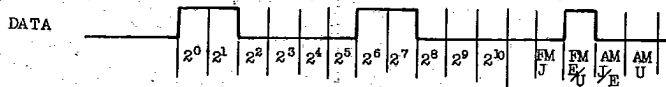

AUDIO DIGITAL IC

TC9137BP/BF

T-50-17

d. Data, CK-1 and CK-2 Outputs

Data, CK-1 and CK-2 are transmitted under the following conditions.

1. When power is ON.
2. During AUTO/MANUAL UP or DOWN scan
3. When the preset memory is read.
4. When FM and AM are switched.

6. MUTING OUTPUT

To prevent generation of noise during the key operation, TC9137BP/BF transmits muting output at the following timings. This muting output can be used for temporary sound arresting of audio signal.

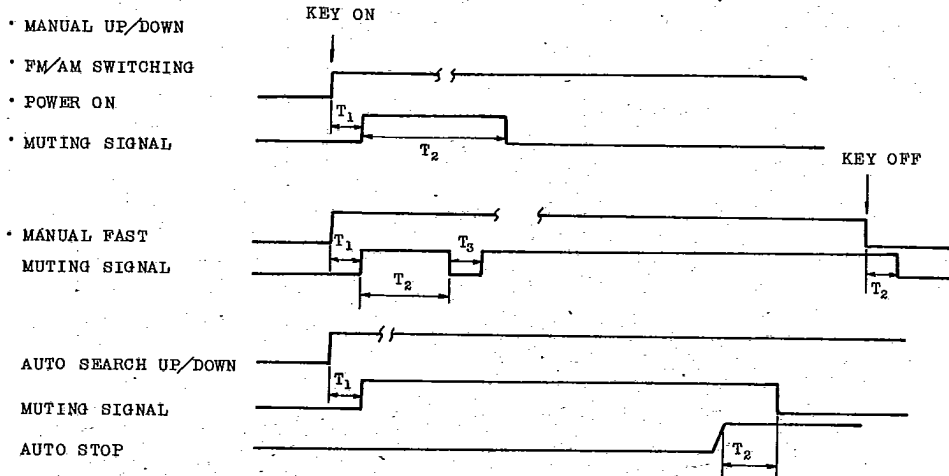

- T_1 Approx. 3 msec
- T_2 $6/f_{OSC}$ (≈ 300 msec)
- T_3 $8/f_{OSC}$ (≈ 400 msec)

TC9137BP/BF

T-50-17

7. INHIBIT FUNCTION

This is the function to completely shut off I/O of LSI for preventing flow out or conduction of current into LED lamps when the memory is backed up by supplying voltage to TC9137BP/BF only from a battery, etc. with the power supply of the set turned off.

Further, the above-mentioned read of destination is carried out under this state.

7-1) Control of Inhibit Function

TC9137BP/BF has $\overline{\text{INH}}$ terminal. When this terminal is set at "L" level, the inhibit function works out.

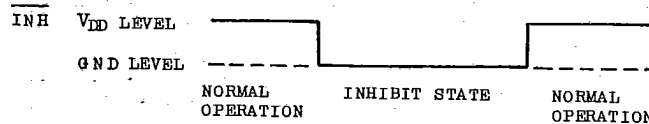

7-2) Operation of TC9137BP/BF under Inhibit State

Operation of TC9137BP/BF under the inhibit state differs from normal operation and will be as follows:

- Oscillations of OSC and the crystal oscillator are stopped, clock is no longer supplied in LSI, and TC9137BP/BF is placed in a completely stationary state.
- During the reading of all operating keys, TC9137BP/BF is placed in a locked state and any key operation is not accepted.
- Under the inhibit state, $H_1 \sim H_5$ and $L_1 \sim L_4$ terminals and the buffer transistors of $\overline{\text{STO}}$ and $\overline{M_1} \sim \overline{M_6}$ are turned OFF and no LED will illuminate. In addition, all other outputs become "L" level.

AUDIO DIGITAL IC

TC9137BP/BF

7-3) Reads of Destination Data

As mentioned above, destination data is decided by state of E_1 and E_2 terminals. This data reading is carried out when the inhibit terminals is at "L" level. It is therefore necessary to force the inhibit terminal to return later than V_{DD} terminal.

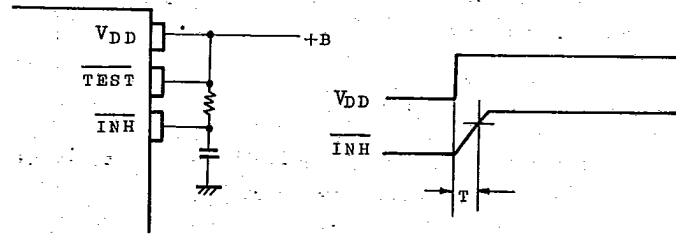

T = READS OF DESTINATION DATA
 $\geq 100 \mu \text{sec}$

7-4) Examples of Memory Backup Circuit with $\overline{\text{INH}}$ Terminal

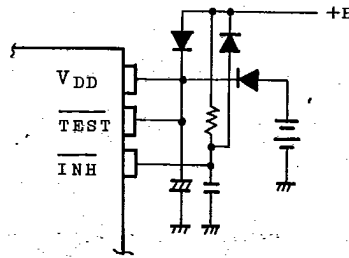

BACKUP BY USE OF BATTERY

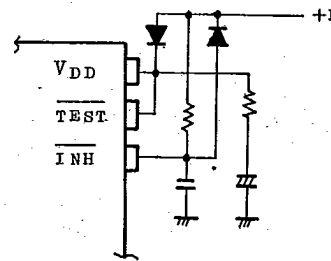

BACKUP BY USE OF CAPACITOR

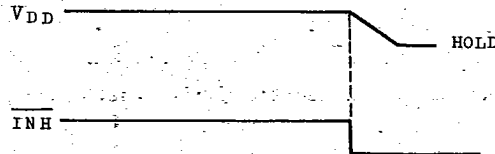

TC9137BP/BF

T-50-17

It is necessary to bring $\overline{\text{INH}}$ terminal at "L" level immediately after power is turned OFF.

Back up V_{DD} has been guaranteed up to 2V and current at this time is 10 μA or below.

8. PEE SOUND

During the key operation, band switching or scanning, a pulse of about 2.5 kHz is transmitted for a specified period for confirming the operation.

BAND SWITCHING OR MEMORY



READ MANUAL UP/DOWN



This output is transmitted one time or continuously as illustrated above only when frequency is updated.

9. OTHERS

9-1) When it is desired to automatically stop the set at integer times frequency of 100 kHz in FM in Europe.

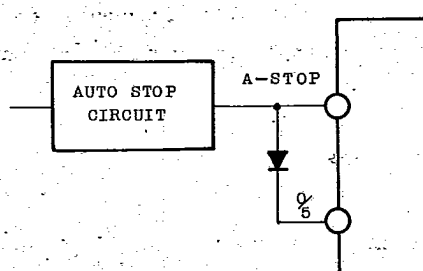

AUDIO DIGITAL IC

TC9137BP/BF

T-50-17

As the 0/5 terminal will become "L" level at integer times frequency of 100 kHz, no auto-stop signal is accepted at 50 kHz in the above circuit.

9-2) Test Mode (E₁ and E₂ Terminals)

When both E₁ and E₂ terminals are brought to "L" level, TC9137P is placed in the test mode, and

- (1) 25 kHz (FM Mode), 9 kHz (AM_{J/E} Mode) and 10kHz (AM_U Mode) of reference frequency are transmitted at Pee terminal.
- (2) All LED lamps illuminate.

Accordingly,

As the result of (1), it is easy to match crystals.

As the result of (2), it is possible to check erroneous wiring, short-circuit, open-circuit, etc. of LED.

9-3) Power ON Timing

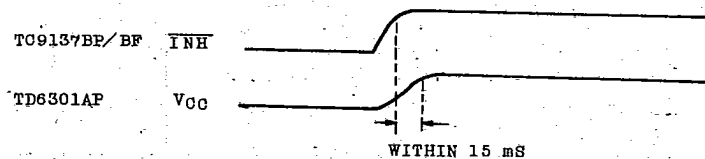

When returned from the inhibit state to the normal state, TC9137BP/BF transfers frequency data of the last frequency memory to TD6301AP and therefore, the power supply of TD6301AP must have risen at that point of time.

TC9137BP/BF

T-50-17

APPLICATION CIRCUIT BY LED DISPLAY (TC9137BP/BF)

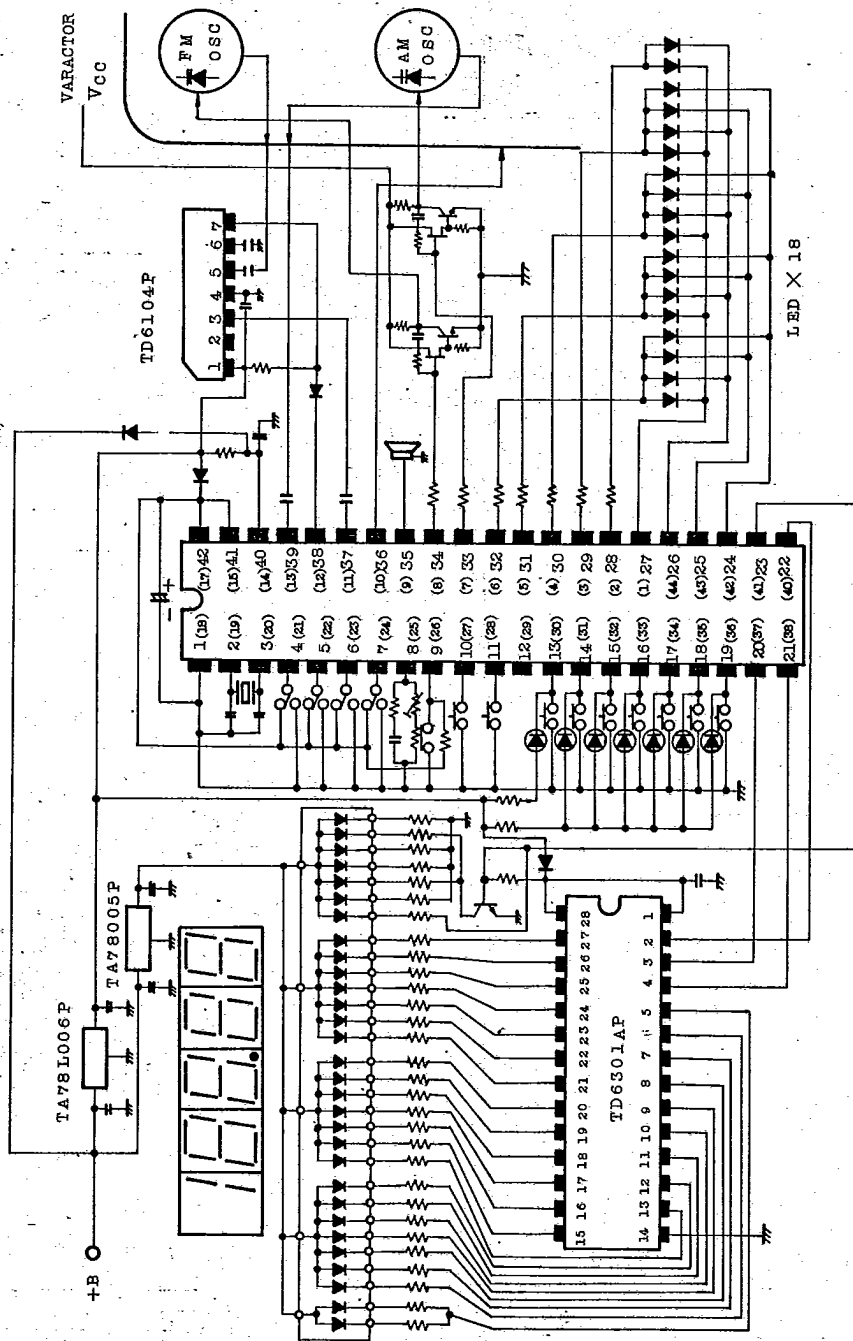

Those shown in () are terminal No.s of TC9137BF

AUDIO DIGITAL IC

TC9137BP/BF

T-50-17

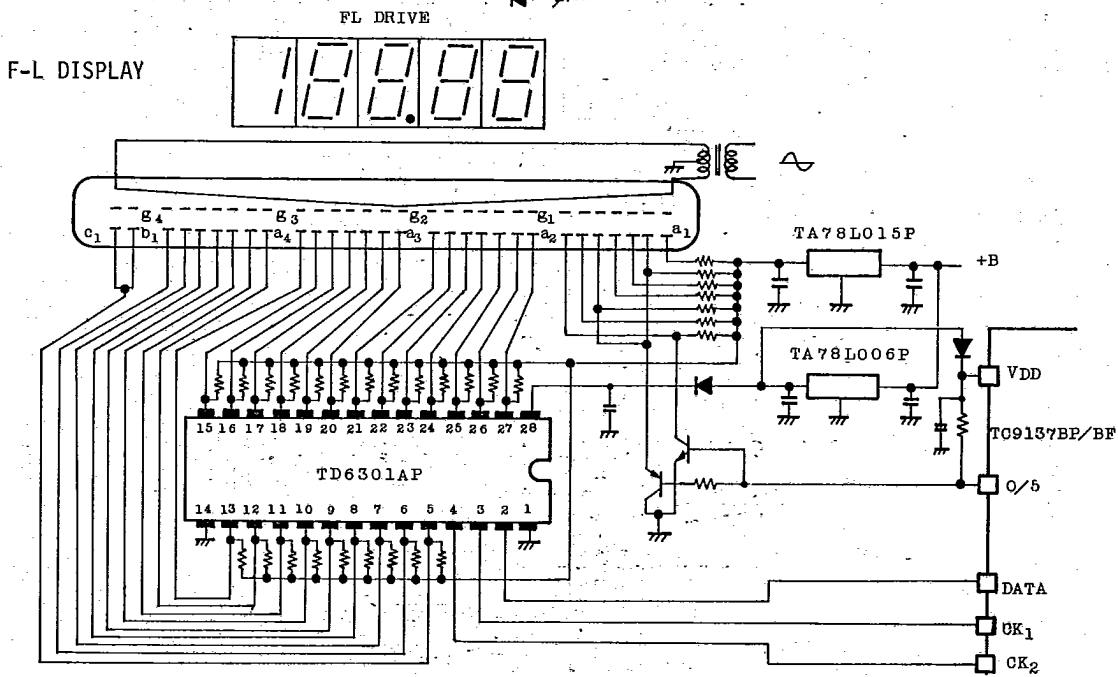
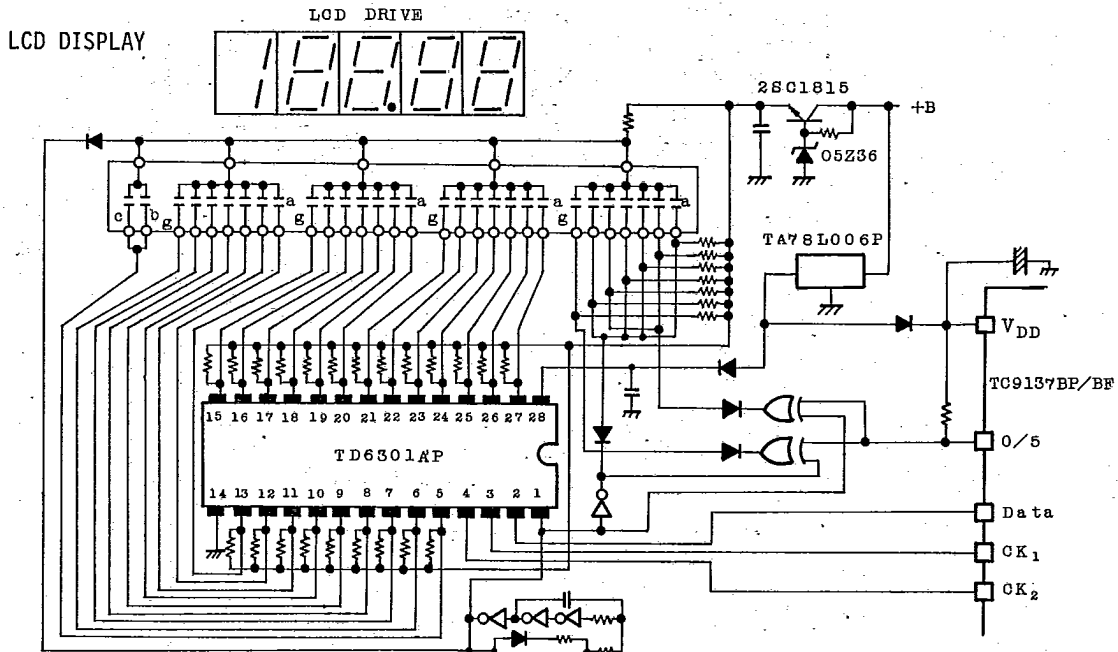

TOSHIBA

TC9137BP/BF

T-50-17

FL-DISPLAY

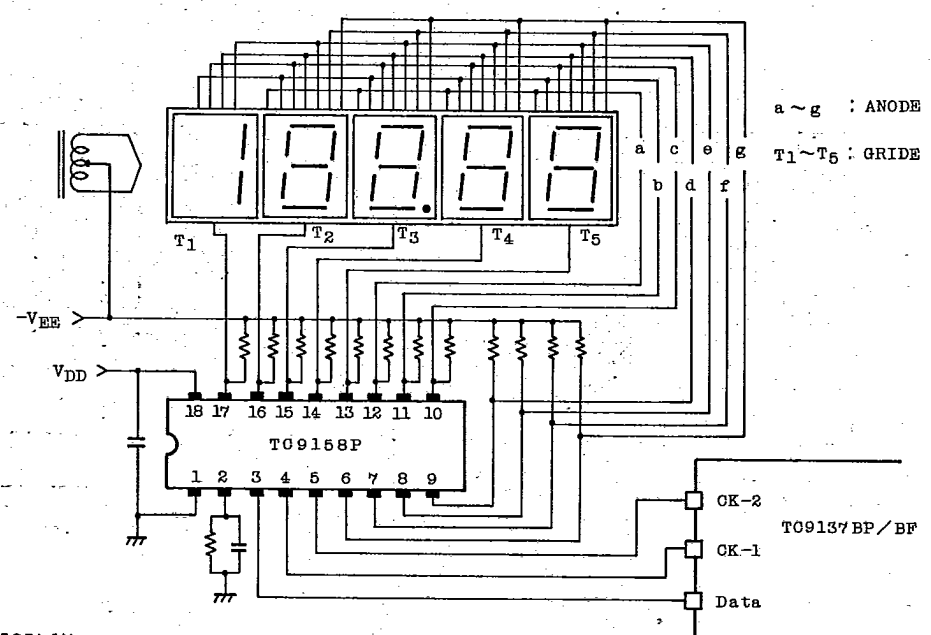

LED DISPLAY

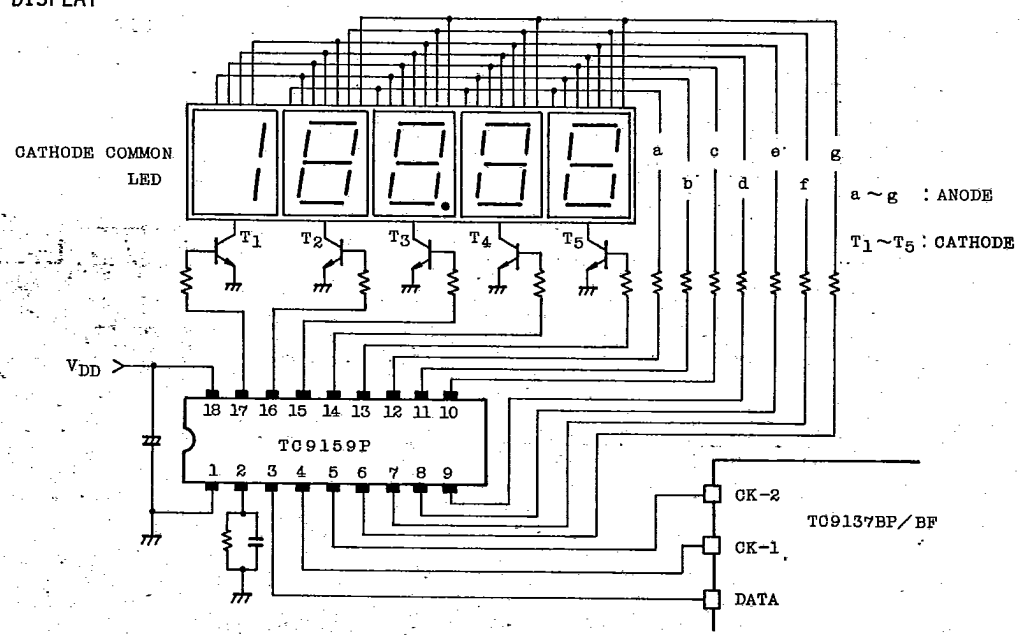

AUDIO DIGITAL IC

TC9137BP/BF

T-50-17

Graph (1) OSCILLATION CIRCUIT

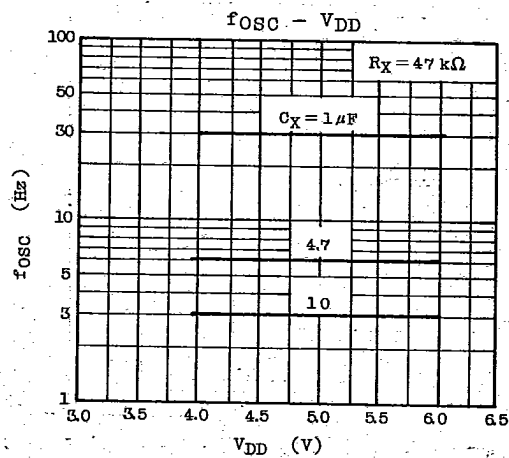
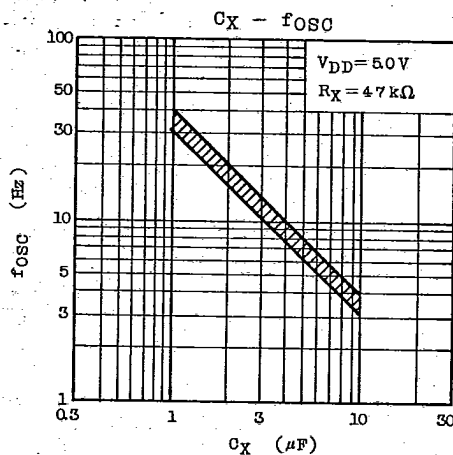
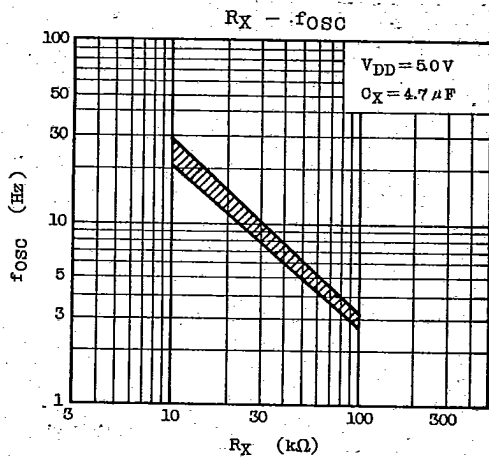

TEST CIRCUIT

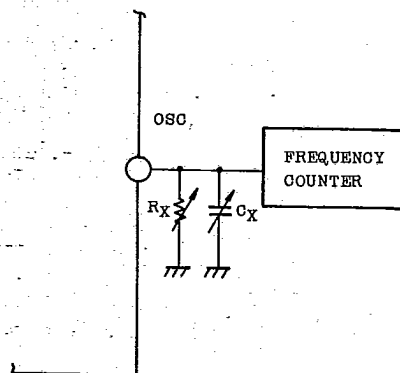

TOSHIBA

TC9137BP/BF

T-50-17

Graph (2)

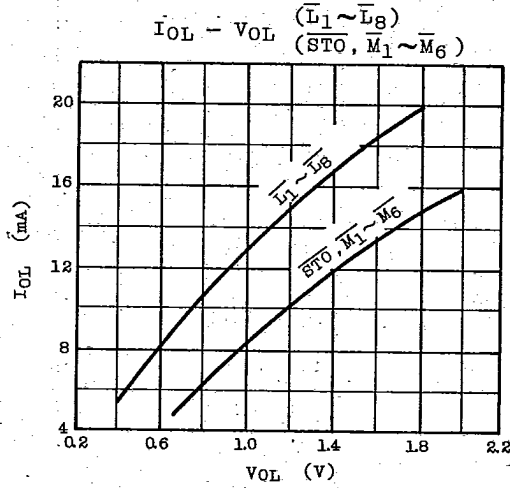

TEST CIRCUIT

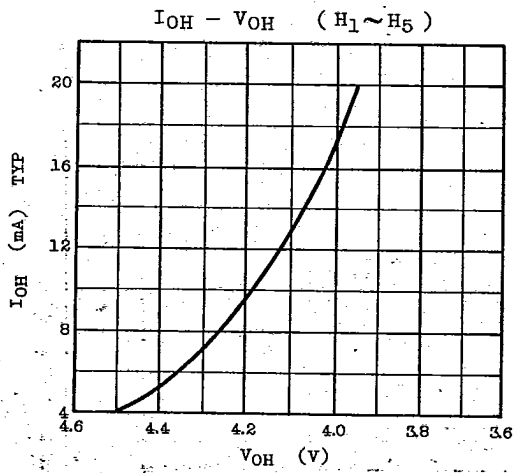
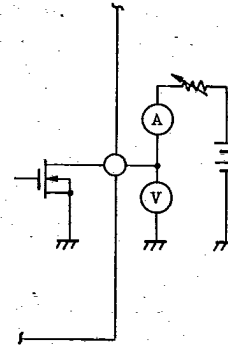

TEST CIRCUIT

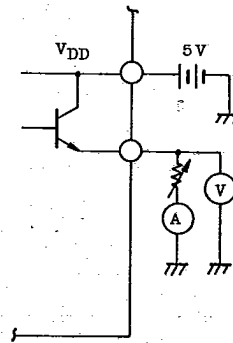

AUDIO DIGITAL IC