

DATA SHEET



PCF50603

Controller for power supply
and battery management

Preliminary specification

2003 Oct 31

Controller for power supply and battery management

PCF50603

CONTENTS

1	FEATURES	8.6	Backup battery charger (BBC)
1.1	System control	8.7	SIM card interface (SIMI)
1.2	Supply voltage generation	8.8	Battery voltage monitor (BVM)
1.3	Battery management	8.9	Temperature high sensor (TS)
1.4	Subscriber identity module card interface	8.10	Real time clock (RTC)
2	APPLICATIONS	8.11	Pulse-width modulator (PWM1 and PWM2)
3	GENERAL DESCRIPTION	8.12	LED modulator (LED1 and LED2)
4	QUICK REFERENCE DATA	8.13	General purpose outputs (GPO)
5	ORDERING INFORMATION	9	LIMITING VALUES
6	BLOCK DIAGRAM	10	CHARACTERISTICS
7	PINNING	11	APPLICATION INFORMATION
8	FUNCTIONAL DESCRIPTION	12	PACKAGE OUTLINE
8.1	On/off control	13	SOLDERING
8.1.1	Operating states	13.1	Introduction to soldering surface mount packages
8.1.2	Reset generation	13.2	Reflow soldering
8.1.3	Watchdog timer	13.3	Wave soldering
8.1.4	Automatic restart after battery removal	13.4	Manual soldering
8.1.5	Debounce filters	13.5	Suitability of surface mount IC packages for wave and reflow soldering methods
8.2	Serial interface (I ² C-bus)	14	DATA SHEET STATUS
8.3	Interrupt controller (INT)	15	DEFINITIONS
8.4	Power supply modules	16	DISCLAIMERS
8.5	Main battery charger (MBC)	17	PURCHASE OF PHILIPS I ² C COMPONENTS
8.5.1	Supported charger plugs		
8.5.2	External components		

Controller for power supply and battery management

PCF50603

1 FEATURES

1.1 System control

- Serial 400 kHz I²C-bus interface to transfer the control data between the PCF50603 and the host controller
- On/Off Control (OOC) module to control the power ramp-up and ramp-down sequences for the handset. Furthermore it determines the supported system operating states: NOPOWER, SAVE, STANDBY and ACTIVE to realize minimum power consumption in all states.
- Internal Current Controlled Oscillator (CCO) generates the internal high clock frequency. The generated frequency is typically 3.6 MHz.
- An accurate 32.768 kHz oscillator. This oscillator can be used to supply the 32 kHz clock domains in the system, to improve the accuracy of the internal clock and to reduce the power consumption of the PCF50603.
- Interrupt controller (INT) that generates the interrupt request for the host controller. All interrupt sources can be masked.
- The Real Time Clock (RTC) module uses the 32 kHz clock to provide time reference and alarm functions with wake up control for the handset
- One accessory recognition pin with debounce filters and capability to start up the system (REC1_N)
- One accessory detection comparator input pin with programmable threshold levels that issues an interrupt when an accessory is connected (REC2_N)
- Two Pulse-Width Modulators (PWM1 and PWM2) which generate an output voltage with programmable duty cycle and frequency
- Two LED modulators (LED1 and LED2) capable of generating eight different blinking patterns with eight different repetition periods
- Three General Purpose Outputs (GPO) programmable via the serial interface. The GPOs are open-drain NMOST outputs, capable of handling the full battery voltage range and high sink currents. The GPOs can be programmed to be continuously active LOW or 3-state, in addition the GPO outputs can be controlled by the LED or PWM modulators.
- Watchdog timer that can be activated by software.

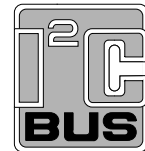

1.2 Supply voltage generation

- The power supplies have three programmable activity modes (OFF, ECO and ON). In the ACTIVE state, the operation modes can be selected by the two external pins PWREN1 and PWREN2.
- One Charge Pump (CP) with programmable output voltage for the supply of white or blue LEDs
- Two 100 mA LDO voltage regulators (RF1REG and RF2REG) with fixed output voltage (mask programmable) for RF supplies. RF1REG and RF2REG are optimized for low noise, high power supply rejection and excellent load regulation.
- Two 150 mA LDO voltage regulators (D1REG and D2REG) optimized for small external capacitors. D1REG provides a programmable output voltage, D2REG provides a fixed output voltage (mask programmable).
- One 150 mA LDO voltage regulator (IOREG) dedicated for the supply of the I/O pads. IOREG has a fixed output voltage (mask programmable) and is optimized for a small external capacitor.
- One 100 mA LDO voltage regulator (LPREG) with fixed output voltage (mask programmable). In low power operation (ECO) mode LPREG can be used to permanently supply parts in the system in all activity states.
- One 100 mA LDO voltage regulator (D3REG) with programmable output voltage. D3REG is optimized for a small external capacitor.
- One 250 mA LDO voltage regulator (HCREG) with programmable output voltage. The high current HCREG is optimized for applications like hands-free audio.
- D1REG, D2REG, D3REG, IOREG and LPREG support ECO mode. In this mode the output current is limited to 1 mA and the internal power consumption is reduced significantly.
- The Temperature high Sensor (TS) provides thermal protection for the whole chip
- Enhanced ESD protection on all pins that connect to the main battery pack
- Microphone bias voltage generator with low noise and high power supply rejection (MBGEN).

Controller for power supply and battery management

PCF50603

1.3 Battery management

- Operates from a three cell NiCd/NiMH or a one cell Li-ion battery pack
- Battery Voltage Monitor (BVM) to detect a too low main battery voltage with programmable threshold levels. A low battery condition is reported via the interrupt mechanism.
- Charger control. There is an option between two different charger control functions, depending on the configuration:
 - Configuration Constant Current Constant Voltage (CCCV). Linear charger control supporting Li-ion as well as NiCd/NiMH battery types for a wide range of battery capacities.
 - Configuration BATMAX comparator that compares the battery voltage against a programmable threshold voltage. This function can be activated by software and is used to detect the end-of-charge.
- Supports the use of a backup battery that powers at empty main battery situations. The backup battery is used to supply the RTC, the internal state and the LPVDD supply in it's ECO mode. Goldcaps, Li and Li-ion cells are supported.
- Includes a Backup Battery Charger (BBC). A rechargeable backup battery or backup capacitor can be charged from the main battery. For charging, a programmable constant voltage mode is supported.

1.4 Subscriber identity module card interface

- Two different modes that can be selected with the Subscriber Identity Module card Interface (SIMI):
 - Transparent interface including an arbiter and signal level translators
 - Subscriber Identity Module (SIM) card interface with integrated sequencer, arbiter and signal level translators. The sequencer supports and controls card activation and de-activation, warm reset and controlled clock stop for power-down modes.
- Dedicated SIM supply (SIMREG). Supports 3.0 V and 1.8 V cards, including a power saving ECO mode for the power-down mode of the SIM card.
- Enhanced ESD protection on all pins that connect to the SIM card contact pins.

2 APPLICATIONS

- Mobile phones.

3 GENERAL DESCRIPTION

The PCF50603 is a highly integrated solution for power supply generation, battery management including charging and a SIM card interface including supply generation. The device is controlled by a host controller via a 400 kHz I²C-bus serial interface.

4 QUICK REFERENCE DATA

$V_{SS} = \text{REFGND} = \text{GND} = 0 \text{ V}$; $T_{\text{amb}} = -40 \text{ }^{\circ}\text{C}$ to $+85 \text{ }^{\circ}\text{C}$; unless otherwise specified.

SYMBOL	PARAMETER	CONDITIONS	MIN.	TYP.	MAX.	UNIT
V_{BAT}	main battery input voltage		0	–	5.7	V
V_{SAVE}	backup battery input voltage		0	–	5.7	V
V_{CHG}	charger input voltage	DC	0	–	15.0	V
		rectified sine wave; 100 Hz to 120 Hz; note 1	0	–	20.0	V
V_{CHGMIN}	minimum charger voltage enabling MBC module		–	2.7	–	V
f_{CLKCCO}	high clock frequency	32 kHz clock available	3.42	3.6	3.78	MHz

Note

1. Not allowed in CCCV configuration.

**Controller for power supply
and battery management**

PCF50603

5 ORDERING INFORMATION

TYPE NUMBER	PACKAGE		
	NAME	DESCRIPTION	VERSION
PCF50603HN	HVQFN48	plastic thermal enhanced very thin quad flat package; no leads; 48 terminals; body 6 × 6 × 0.85 mm	SOT778-1

Controller for power supply and battery management

PCF50603

6 BLOCK DIAGRAM

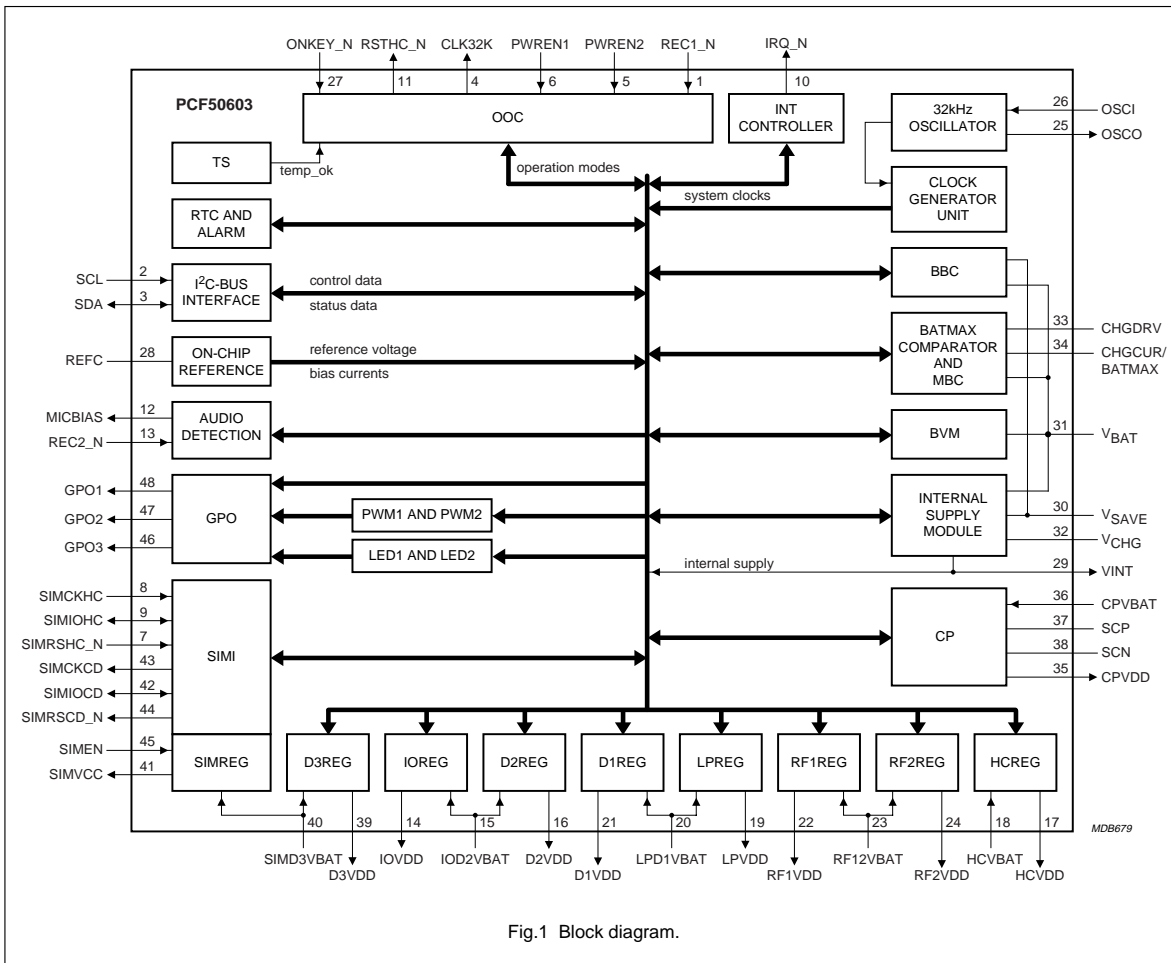

Fig.1 Block diagram.

Controller for power supply and battery management

PCF50603

7 PINNING

SYMBOL	PIN	SUPPLY	DESCRIPTION ⁽¹⁾
V _{SS} and REFGND	–	n.a.	ground and V _{SS} pads of all modules are connected to the ground plane of the package
REC1_N	1	VINT	accessory recognition input with debounce filter (active LOW); input with internal pull-up resistor to VINT
SCL	2	IOVDD	I ² C-bus clock input
SDA	3	IOVDD	I ² C-bus data input and output
CLK32K	4	IOVDD	32.768 kHz digital clock output; in ACTIVE state and IOVDD is on
PWREN2	5	IOVDD	control signal input; selects in combination with PWREN1 the ON, OFF or ECO mode of the linear regulators
PWREN1	6	IOVDD	control signal input; selects in combination with PWREN2 the ON, OFF or ECO mode of the linear regulators
SIMRSHC_N	7	IOVDD	SIM reset input from host controller (active LOW)
SIMCKHC	8	IOVDD	SIM clock input from host controller
SIMIOHC	9	IOVDD	SIM I/O data to or from the host controller with an internal pull-up resistor to IOVDD
IRQ_N	10	IOVDD	interrupt request output to host controller (active LOW); open-drain output with an internal pull-up resistor to IOVDD
RSTHC_N	11	IOVDD	reset output to host controller (active LOW)
MICBIAS	12	n.a.	microphone bias output voltage
REC2_N	13	MICBIAS	accessory recognition input with debounce filter and programmable threshold (active LOW)
IOVDD	14	n.a.	IOREG output voltage
IOD2VBAT	15	n.a.	IOREG and D2REG input voltage
D2VDD	16	n.a.	D2REG output voltage
HCVDD	17	n.a.	HCREG output voltage
HCVBAT	18	n.a.	HCREG input voltage
LPVDD	19	n.a.	LPREG output voltage
LPD1VBAT	20	n.a.	LPREG and D1REG input voltage
D1VDD	21	n.a.	D1REG output voltage
RF1VDD	22	n.a.	RF1REG output voltage
RF12VBAT	23	n.a.	RF1REG and RF2REG input voltage
RF2VDD	24	n.a.	RF2REG output voltage
OSCO	25	VINT	32.768 kHz oscillator output
OSCI	26	VINT	32.768 kHz oscillator input
ONKEY_N	27	VINT	On-key (active LOW); input with internal pull-up resistor to VINT
REFC	28	n.a.	reference voltage bypass capacitor connection
VINT	29	n.a.	internal supply voltage output
V _{SAVE}	30	n.a.	backup battery supply voltage
V _{BAT}	31	n.a.	main battery supply voltage
V _{CHG}	32	n.a.	charger voltage

Controller for power supply and battery management

PCF50603

SYMBOL	PIN	SUPPLY	DESCRIPTION ⁽¹⁾
CHGDRV	33	n.a.	drive of external charger circuitry (configuration CCCV)
CHGCUR/ BATMAX	34	n.a.	configuration CCCV: charger current feedback
			configuration BATMAX: open-drain output of BATMAX comparator
CPVDD	35	n.a.	charge pump output voltage
CPVBAT	36	n.a.	charge pump input voltage
SCP	37	n.a.	switching capacitor positive side
SCN	38	n.a.	switching capacitor negative side
D3VDD	39	n.a.	D3REG output voltage
SIMD3VBAT	40	n.a.	SIMREG and D3REG input voltage
SIMVCC	41	n.a.	SIMREG output voltage
SIMIOCD	42	SIMVCC	SIM I/O data to/from the SIM card; internal pull-up resistor to SIMVCC
SIMCKCD	43	SIMVCC	SIM clock output to the SIM card
SIMRSCD_N	44	SIMVCC	SIM reset output to the SIM card (active LOW)
SIMEN	45	IOVDD	enable SIMI and SIMREG
GPO3	46	n.a.	general purpose open-drain output 3
GPO2	47	n.a.	general purpose open-drain output 2
GPO1	48	n.a.	general purpose open-drain output 1

Note

1. One ESD diode reverse biased to V_{SS} except pin V_{CHG} who has one clamp in series with a 500 Ω resistor connected between pad and V_{SS} .

Controller for power supply
and battery management

PCF50603

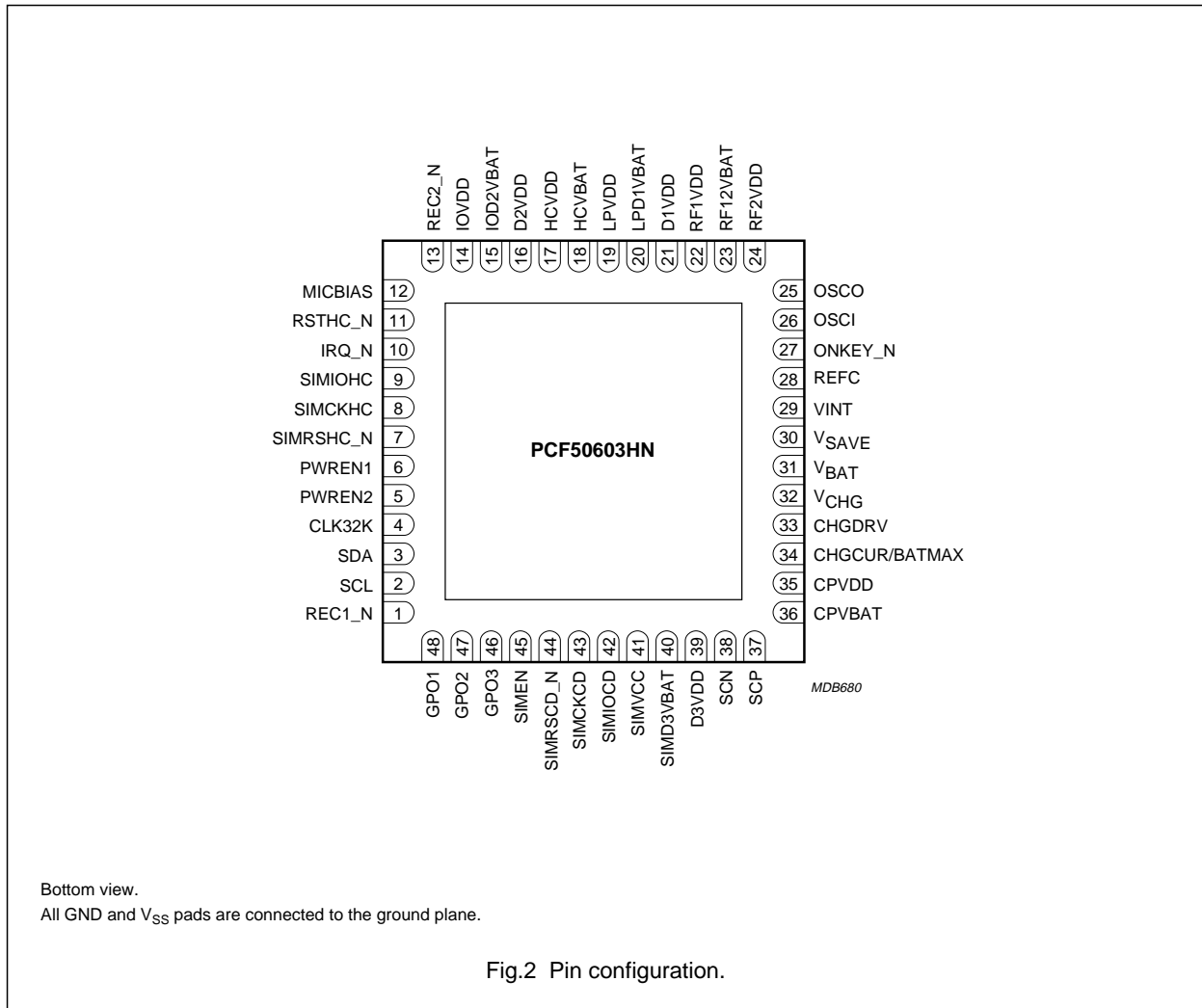

Controller for power supply and battery management

PCF50603

8 FUNCTIONAL DESCRIPTION

8.1 On/off control

8.1.1 OPERATING STATES

The PCF50603 has four operating states (see Fig.3):

- NOPOWER
- SAVE
- STANDBY
- ACTIVE.

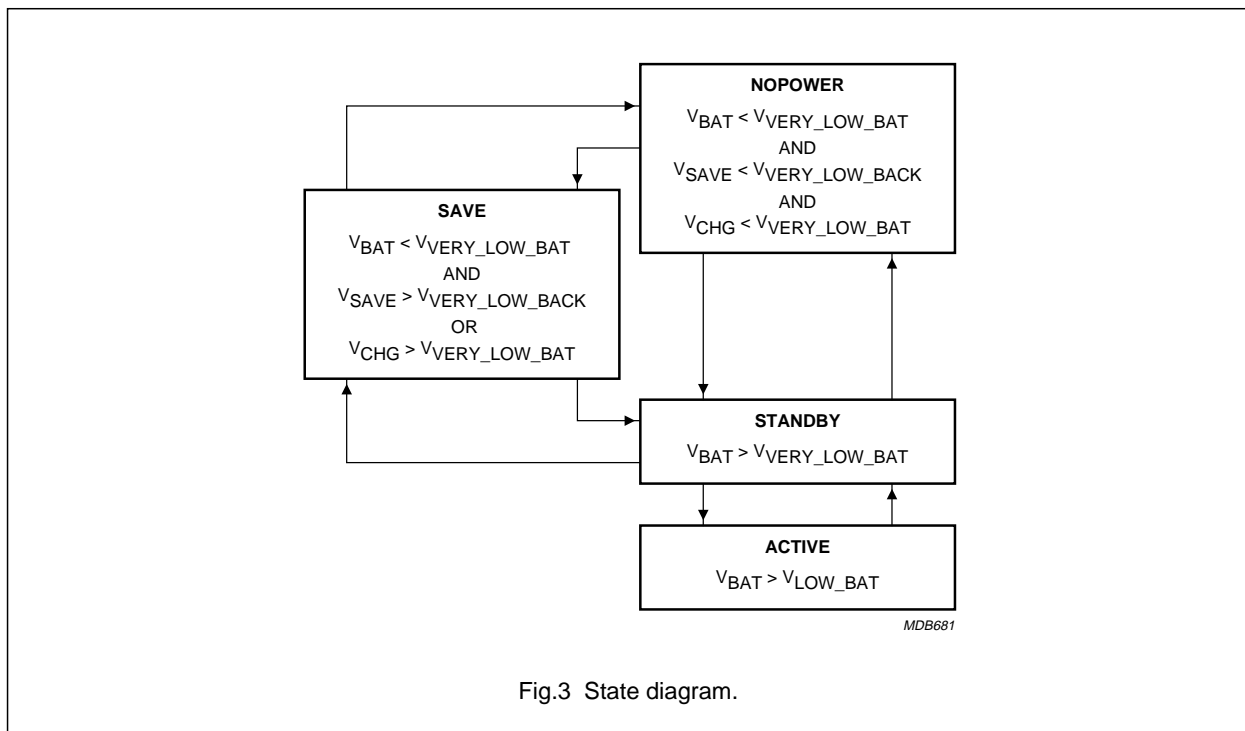

Fig.3 State diagram.

8.1.2 RESET GENERATION

The OOC generates an internal and an external reset each time the system goes from STANDBY to ACTIVE state. All registers for the regulators and converters are reset to their default values.

The RSTHC_N is kept LOW for minimum 10 ms after entering the ACTIVE state. If the IOREG supply is switched off, RSTHC_N becomes LOW again (see Fig.4).

A special condition occurs when the main battery voltage drops below the $V_{VERY_LOW_BAT}$ limit of typically 2.7 V; the RSTHC_N is asserted in order to shut down the host controller immediately (see Fig.5).

Controller for power supply and battery management

PCF50603

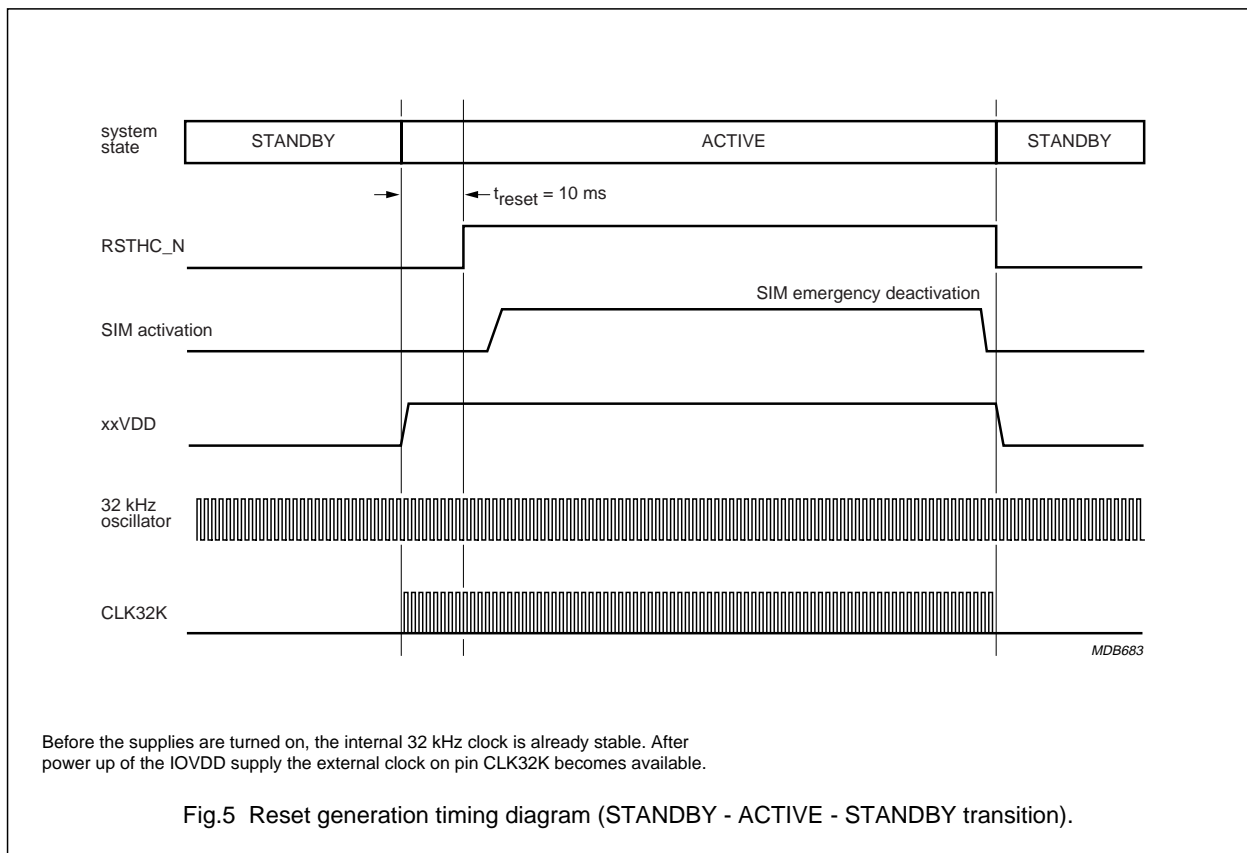
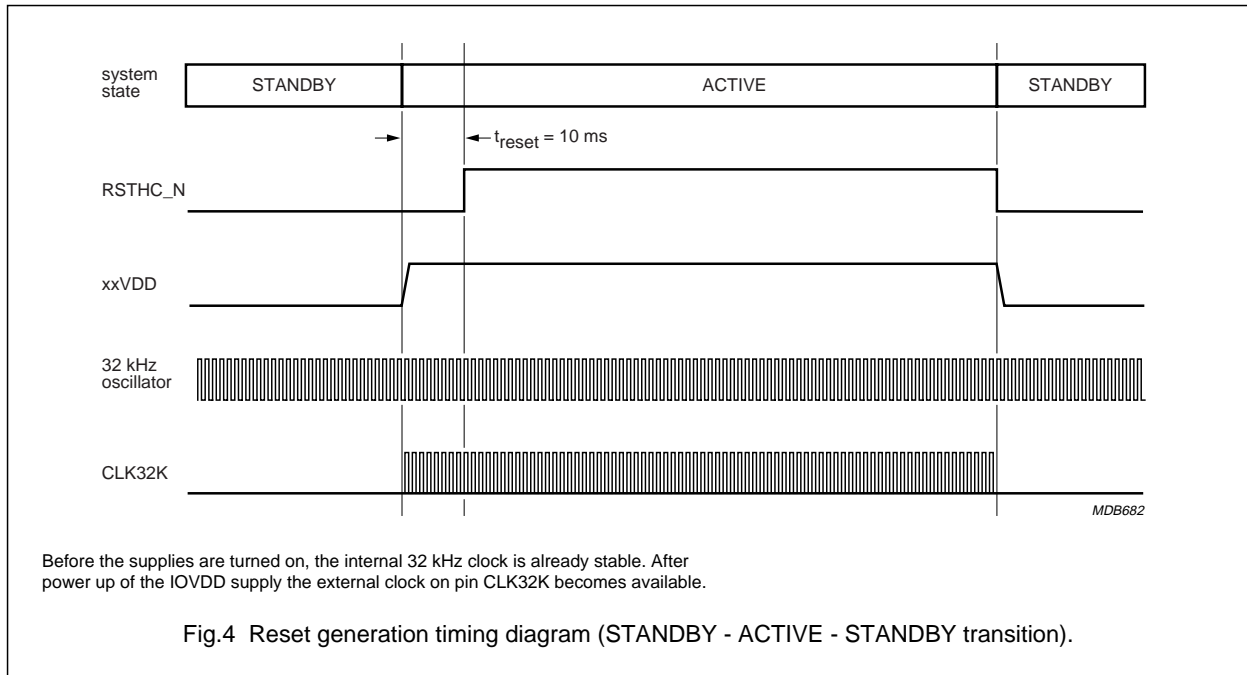

Controller for power supply and battery management

PCF50603

8.1.3 WATCHDOG TIMER

The OOC contains a WatchDog Timer (WDT). By default it is not activated. It can be activated by setting bit WDT_RST in the OOC register to logic 1. Once this bit has been set, the watchdog is enabled, and needs to be cleared once every eight seconds. If the watchdog is not reset in time, the PCF50603 automatically goes to the STANDBY state when the watchdog timer expires. Status bit WDTEXP is set when the watchdog timer expires. After each ACTIVE to STANDBY transition the WDT is disabled and needs to be activated again by software when entering the ACTIVE state.

8.1.4 AUTOMATIC RESTART AFTER BATTERY REMOVAL

The PMU allows for an automatic restart from SAVE to ACTIVE state when the main battery is removed for a period less than two seconds ($t_{BATRMLIM}$). This feature is especially convenient to avoid accidental switch-off of the

phone due to mechanical bounce on the battery. The automatic restart is enabled or disabled by control bit BATRM_EN in the OOC register. By default this automatic restart feature is disabled.

Status bit BATRMSTAT in the OOC2 register indicates whether the PMU returned to ACTIVE state due to a restart after battery removal. The status bit remains active until the PMU returns to STANDBY or SAVE state.

Figure 6 shows the timing for an automatic restart due to battery removal.

This feature is only triggered by battery removal ($V_{BAT} < 2.7\text{ V}$). All other shut-down conditions like, low battery, high temperature, programming GO_STDBY do not trigger this function.

This feature is only applicable upon the condition that a BBC ($V_{SAVE} > V_{VERY_LOW_BACK}$) is available in the system.

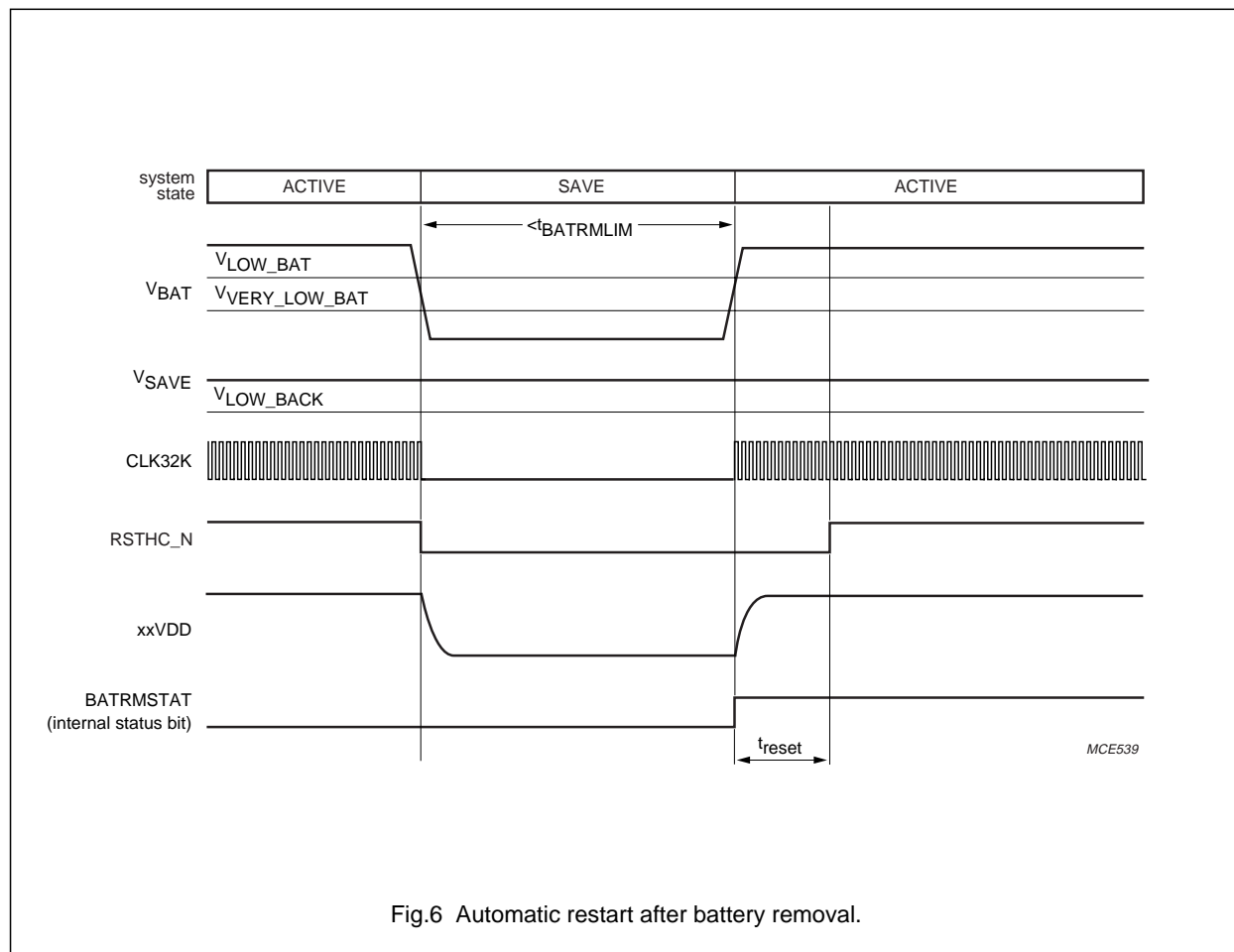

Controller for power supply and battery management

PCF50603

8.1.5 DEBOUNCE FILTERS

Fig.7 is applicable for all debounce filters in the PCF50603.

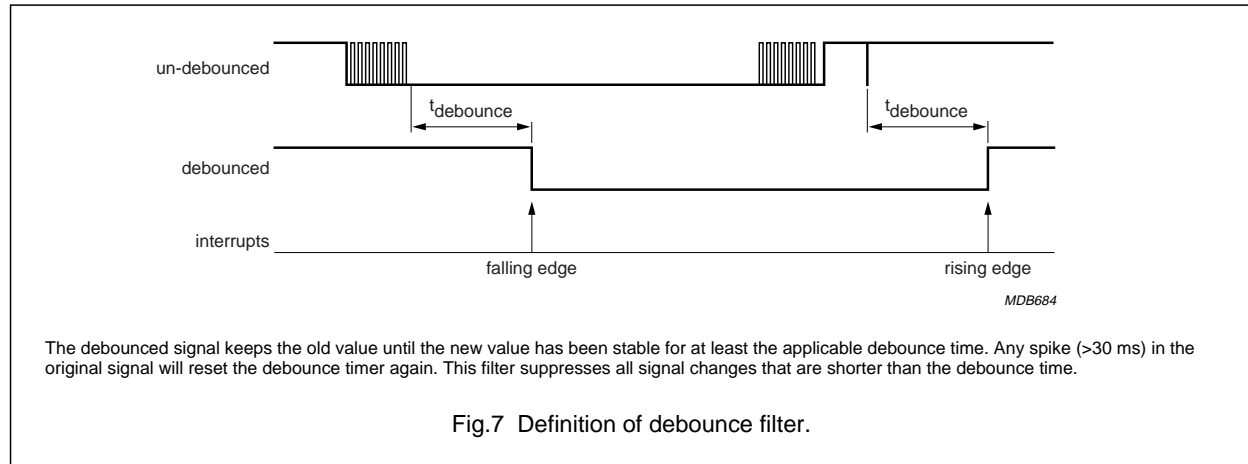

8.2 Serial interface (I²C-bus)

The I²C-bus is the serial interface of the PCF50603. A detailed description of the I²C-bus specification, including applications, is given in the brochure: The I²C-bus and how to use it, order no. 9398 393 40011 or I²C-bus Peripherals Data Handbook IC12.

8.3 Interrupt controller (INT)

The PCF50603 uses the interrupt controller to indicate to the system controller if the status of the PCF50603 change and that an action of the system controller is required. Interrupts can be generated by several modules of the PCF50603. The interrupt generator handles all interrupts with the same priority. Priority setting shall be done by the system controller software.

There are no timing requirements for interrupt service response times. All events that require immediate actions are performed by the PCF50603 without any action by the system controller.

The function of the interrupt module is to capture, mask and combine the interrupt signals from the modules that can generate an interrupt. All interrupts are combined in the interrupt signal IRQ_N. The IRQ_N signal is implemented as an open-drain output with an internal pull-up resistor.

The interrupt module is powered in all states (except NOPOWER) and retains the register values. Events that occur in the STANDBY state, are captured and can be read out by the system controller once the system is in the ACTIVE state.

The IRQ_N signal is asserted in the ACTIVE state whenever one or more PCF50603 interrupts are active.

Each interrupt register (8-bits) is cleared when it is read (R&C) through the I²C-bus interface. New interrupts that occur during a R&C action are captured in an intermediate register (see Figs.8 and 9).

All interrupts related to shut-down conditions (LOWBAT, ONKEY1S and HIGHTMP) are automatically cleared on a transition from ACTIVE to STANDBY state.

All interrupts can be masked: this effectively prevents that IRQ_N is asserted for masked interrupts. Masking is implemented with a mask bit in the mask registers for each interrupt source. Nevertheless, the interrupt status registers still provide the actual interrupt status of the masked interrupts, which allows polling of the interrupt status registers. Note that if the mask bit is cleared for an active interrupt, the IRQ_N line goes LOW at the next falling edge of the output pin CLK32K.

Controller for power supply
and battery management

PCF50603

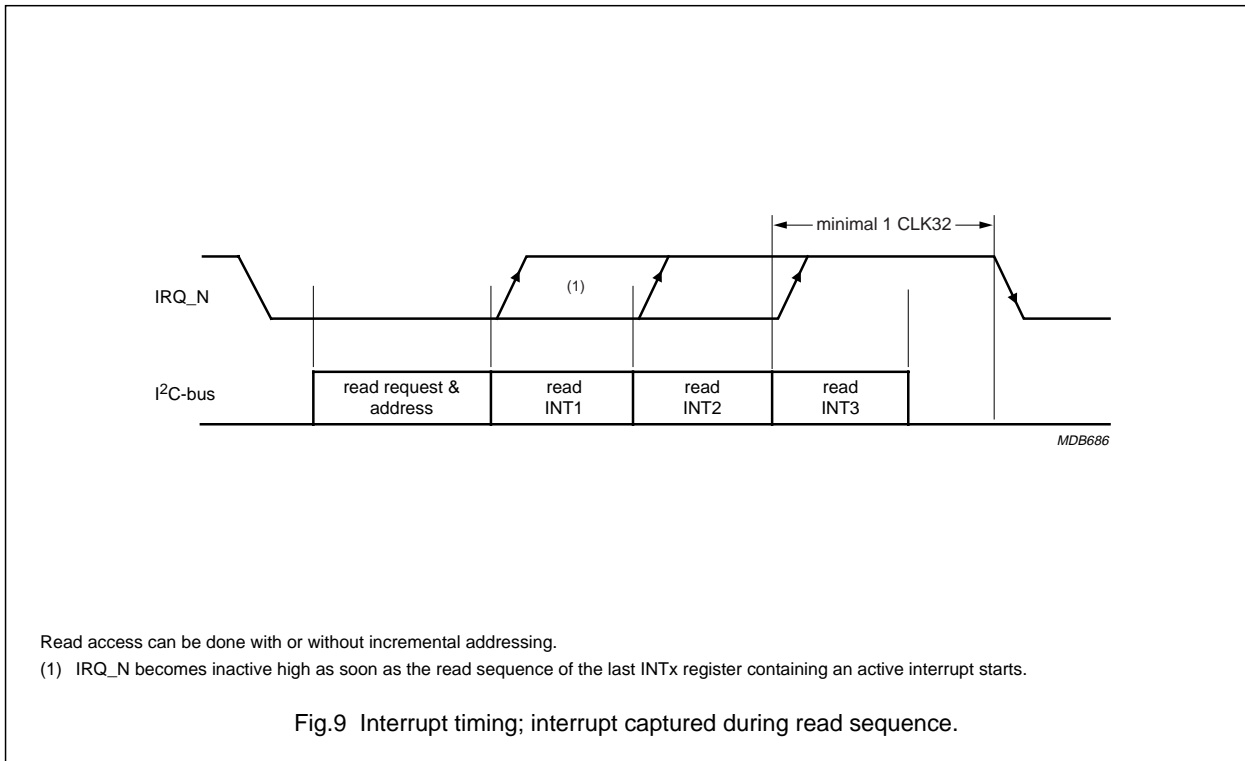
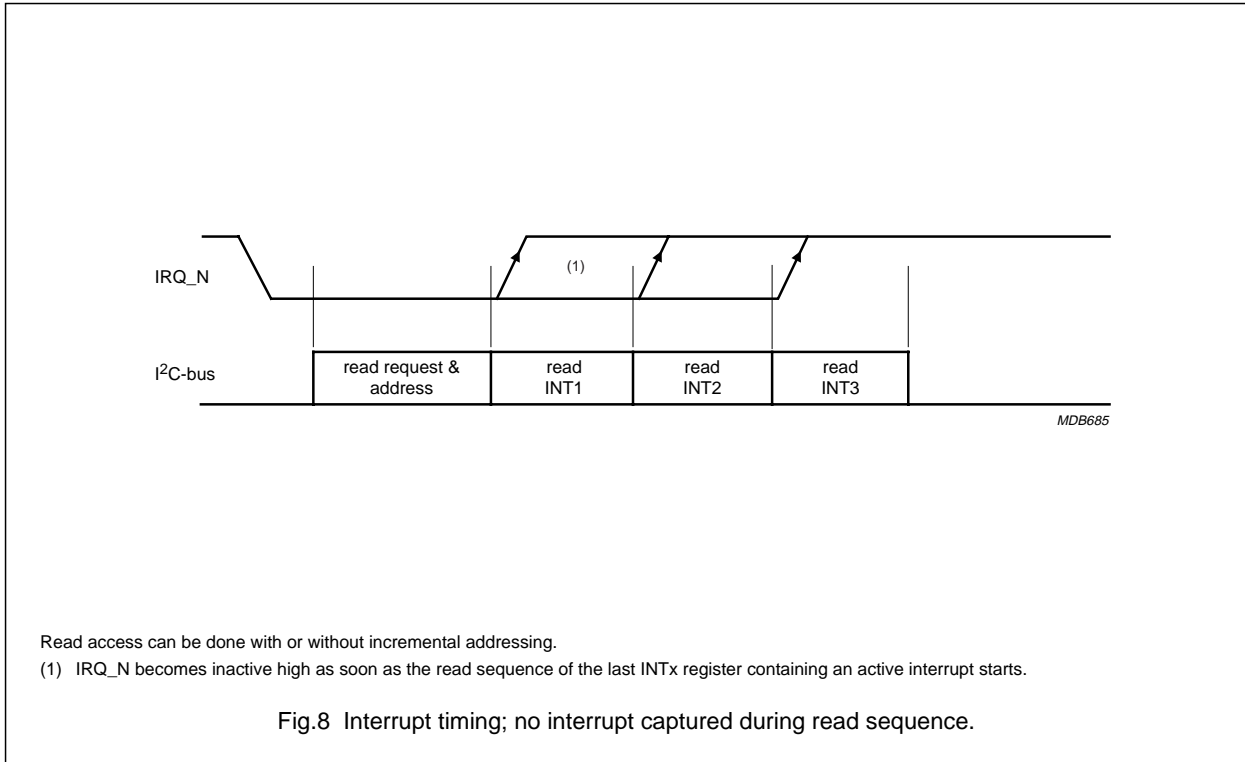

Controller for power supply and battery management

PCF50603

8.4 Power supply modules

In total 11 power supply modules are available in the PCF50603; see Table 1:

- Three regulators for supplying the digital and analog circuitry (D1REG, D2REG and D3REG). These regulators support the ECO mode
- One regulator for high current supply (HCREG)
- One regulator for the SIMI supply (SIMREG)
- One charge pump (CP)
- One regulator for supplying the I/O pads (IOREG). This regulator supports the ECO mode
- One regulator for low power supply (LPREG). This regulator supports the ECO mode, the LPREG is the only regulator that can be enabled in SAVE and STANDBY state (ECO mode only)
- Two low-noise regulators for RF supply (RF1REG and RF2REG)
- One ultra low-noise regulator for supplying a microphone (MBGEN).

Table 1 Power supply modules; $V_{SS} = \text{REFGND} = \text{GND} = 0 \text{ V}$; $T_{\text{amb}} = -40 \text{ }^\circ\text{C}$ to $+85 \text{ }^\circ\text{C}$; unless otherwise specified.

SUPPLY NAME	NOMINAL CURRENT (mA)	MINIMUM VOLTAGE (V)	MAXIMUM VOLTAGE (V)	VOLTAGE STEPS (mV)	RESET VOLTAGE (V)	ECO MODE	PSRR ⁽¹⁾ (dB)	SIZE EXTERNAL CAPACITOR ⁽²⁾ (nF)
Programmable power supplies								
D1REG	150	1.20	3.20	100	note 3	yes	60	470
D3REG	100	1.20	3.20	100	note 3	yes	60	470
HCREG	250 ⁽⁴⁾	2.60	3.20	200	note 3	no	60	4700
SIMREG	20	1.80	3.00	–	1.8	yes ⁽⁵⁾	60	1000
CP	75 ⁽⁶⁾	3.50	5.00	500	note 3	no	–	220/4700 ⁽⁷⁾
Fixed power supplies, mask programmable								
D2REG	150	1.20	3.20	100	note 3	yes	60	470
IOREG	150	1.20	3.20	100	note 3	yes	60	470
LPREG	100	1.20	3.20	100	note 3	yes	60	470
RF1REG ⁽⁸⁾	100	2.60	3.00	100	note 3	no	70	4700
RF2REG ⁽⁸⁾	100	2.60	3.00	100	note 3	no	70	4700
Fixed power supply								
MBGEN	1.5	2.15	2.15	–	2.15	yes	110	4700

Notes

1. Typical value, $100 \text{ Hz} < f < 1000 \text{ Hz}$.
2. Typical values assume X5R or X7R type of capacitor.
3. Mask programmable for reset settings of different types.
4. Under specific conditions a nominal current of 300 mA can be delivered.
5. When SIMI is in Power-down mode.
6. Maximum current depends on the selected output voltage. At 3.50 V, 4.00 V and 4.50 V the maximum output current is 75 mA. At 5.00 V output voltage the maximum output current is 50 mA.
7. The CP module requires both a switching capacitor as well as an output capacitor.
8. Optimized for low noise (30 μV RMS value, $400 \text{ Hz} < f < 80 \text{ kHz}$).

Controller for power supply and battery management

PCF50603

8.5 Main battery charger (MBC)

The main battery charger (MBC) module provides a complete constant-current/constant-voltage linear charger controller for lithium-ion (Li-ion) batteries (in CCCV configuration) or a programmable battery threshold level detector for end-of-charge indication (configuration BATMAX). Nickel-cadmium (NiCd) and Nickel metal hydride (NiMH) batteries can also be charged with constant current.

Only an external power PNP transistor is required to control the charge current. The CC and CCCV control circuitry is fully integrated in the PCF50603 charging module.

In CCCV configuration the charging process for Li-ion/Li-pol batteries is performed under control of the host controller. The communication between the PCF50603 charger module and the host controller is interrupt based, which simplifies the control of the PCF50603.

The fast charge current is determined by the value of the external sense resistor. The charge current in the pre and trickle charge phase is programmable as a ratio of the fast charge current.

In BATMAX configuration an end-of-charge indication is available on the BATMAX pin.

8.5.1 SUPPORTED CHARGER PLUGS

The PCF50603 charger circuitry supports the following type of charger plugs (see Fig.10):

- Regulated charger plugs with output voltage at least 0.5 V above the battery voltage with a maximum of 10 V and with current limitation up to 3C of the used battery (CCCV and BATMAX configuration)
- Non regulated charger plugs with peak output voltages up to 20 V with a duration of less than 14 ms and with current limitation up to 3C of the used battery (BATMAX configuration only).

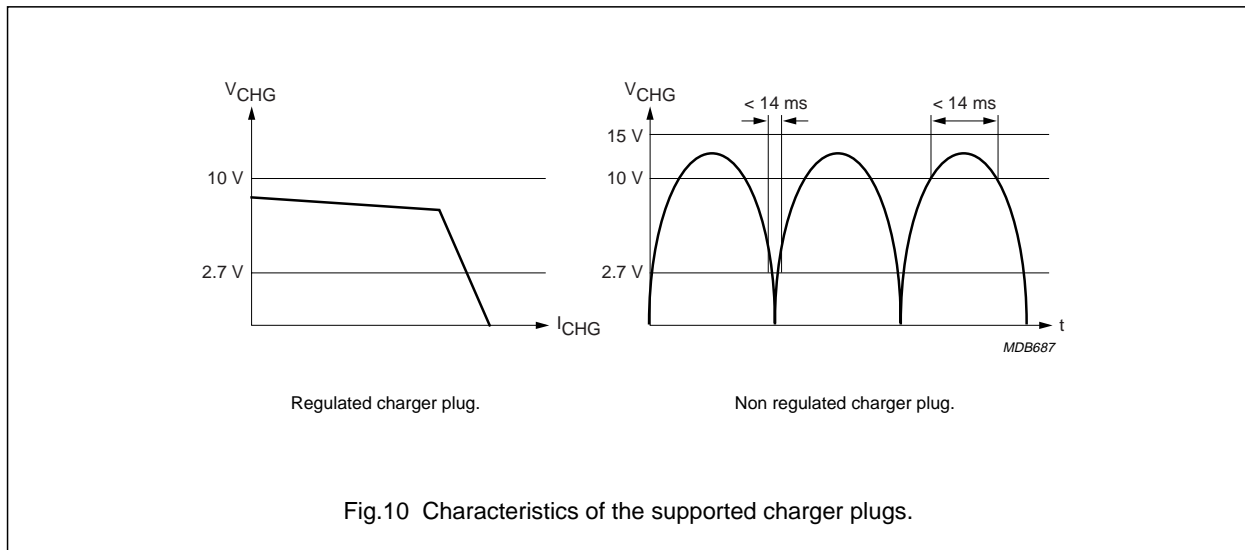

Controller for power supply and battery management

PCF50603

8.5.2 EXTERNAL COMPONENTS

A small discrete circuit must be used to control the charge current (see Fig.11).

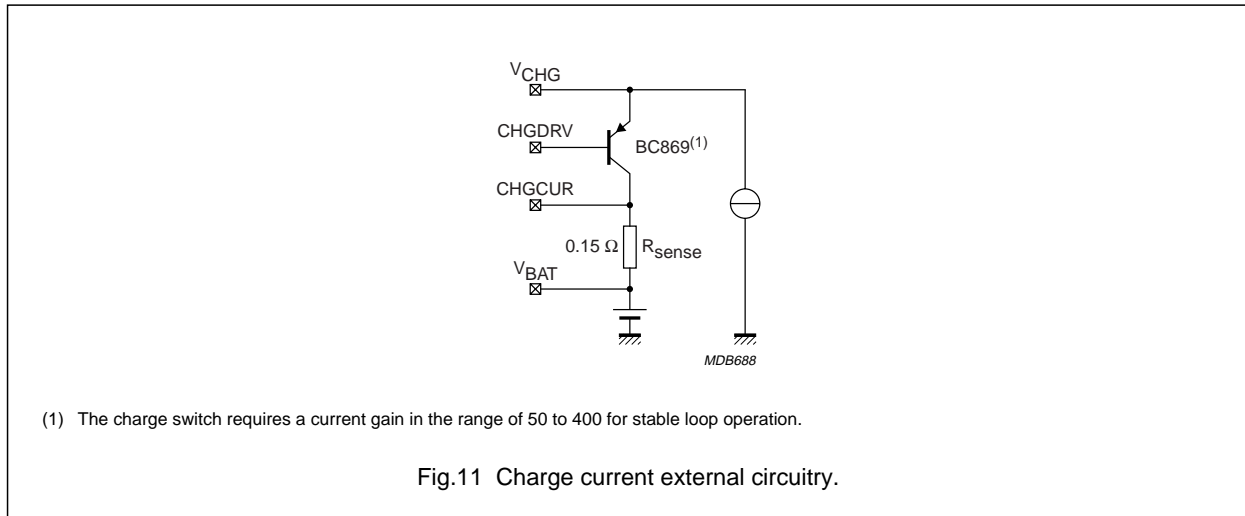

8.6 Backup battery charger (BBC)

The BBC is implemented as a voltage limited current source with a selectable output resistor. It offers the following features:

- Selectable output resistor to reduce the current at higher voltages
- Four programmable charge currents
- Two programmable maximum limiting voltages
- The BBC can be enabled in the ACTIVE state; in all other states the BBC is disabled.

8.7 SIM card interface (SIMI)

The SIMI provides the facilities to communicate with SIM. It offers the following features:

- Support for transparent mode. The host controller controls the communication with the SIM card, including the activation and deactivation sequences.
- Support for sequencer mode. The internal sequencer of the PCF50603 performs the activation and deactivation sequences.
- Includes a dedicated linear regulator for the SIM card supply (SIMREG) supporting both 1.8 V and 3.0 V cards
- Provides level-shifters for the SIM interfacing signals. The level-shifters translate the host controller signal levels (IOVDD) to SIM card signal levels (SIMVCC) and vice versa.

- In transparent mode the SIMEN input allows the host controller to have direct control over the SIM card supply. In sequencer mode the SIMEN input indicates the presence of a SIM card.
- Enhanced ESD protection on all SIM contact pins
- The SIMI and SIMREG can be enabled in the ACTIVE state. In all other states the SIMI and SIMREG are disabled.

8.8 Battery voltage monitor (BVM)

The BVM monitors the main battery voltage. It offers the following features:

- Programmable low battery threshold (V_{LOW_BAT})
- Hysteresis and selectable debounce filter built in to prevent fast cycling
- The BVM is enabled in all activity states.

The BVM observes permanently the main battery voltage and generates a LOWBAT interrupt if the battery voltage drops below the programmed threshold voltage V_{LOW_BAT} (see Fig.12). When a LOWBAT interrupt is generated in ACTIVE state, the host controller should initiate a transition to STANDBY state. In case the host controller does not initiate a transition to the STANDBY state within eight seconds after the interrupt occurred, the OOC forces the PCF50603 to the STANDBY state in order to prevent a too deep discharge of the battery.

Controller for power supply and battery management

PCF50603

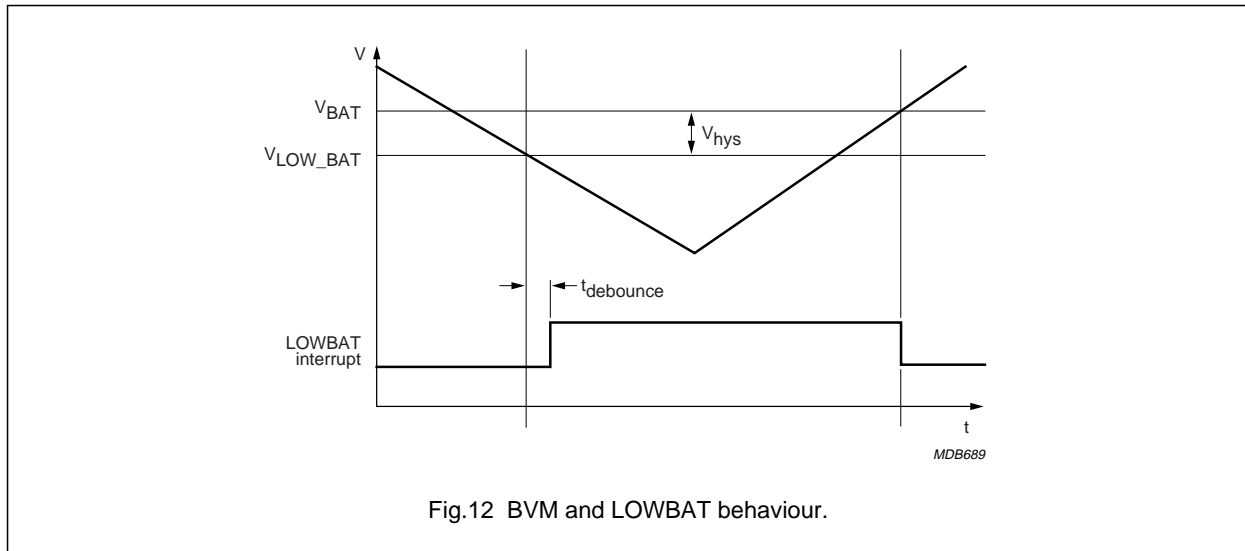

8.9 Temperature high sensor (TS)

The TS monitors the junction temperature of the PCF50603. It offers the following features:

- Fixed temperature threshold
- Hysteresis and debounce filter built in to prevent fast cycling
- The TS is enabled in ACTIVE state, in all other states the TS is disabled.

The behaviour of the TS is shown in Figure 13.

A HIGHTMP interrupt is generated when the temperature threshold is passed for more than 62 ms (debouncing time). When a HIGHTMP interrupt is generated the host controller should initiate a transition to STANDBY state. In case the host controller does not initiate a transition to the STANDBY state within 1 second after the interrupt occurred, the OOC forces the PCF50603 to the STANDBY state in order to prevent damage to the circuit.

The hysteresis and debounce time have been built in to prevent fast cycling of the HIGHTMP signal.

The TS can not be disabled via the I²C-bus.

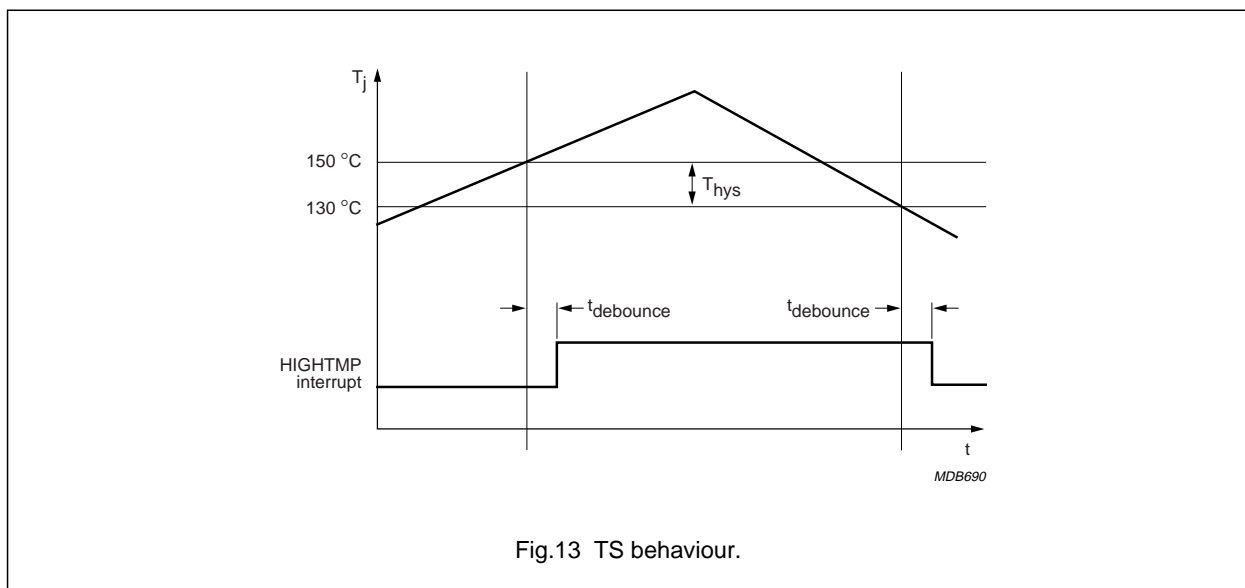

Controller for power supply and battery management

PCF50603

8.10 Real time clock (RTC)

The RTC module provides the time information to the handset based on a 1 Hz clock frequency. Basically it is a 32-bit counter counting elapsed seconds.

- The RTC module contains one alarm function that generates an interrupt if the actual RTC time equals the content of the alarm register. The alarm registers are preset to all 1 s which effectively disables the alarm; effectively no alarm interrupt will be generated as long as the RTC counter does not overflow. It is recommended to mask the ALARM interrupt before a new value is written to the alarm registers, in order to prevent interrupts during the write actions (a new setting may require up to 4 register writes).
- The RTC module is able to generate an interrupt each second (SECOND interrupt) as well as each minute (MINUTE interrupt). When the RTC starts up the first time (after transition from NOPOWER state) the minute interrupt is aligned with each 60 seconds crossing. If the synchronization with the 60 second crossing is required after reprogramming the RTC time registers it is up to the software to program the RTC time registers with a modulo 60 value.

8.11 Pulse-width modulator (PWM1 and PWM2)

The two PWMs (PWM1 and PWM2) offer the following features:

- Programmable frequency and duty cycle
- Any of the GPOs can be connected to either the PWMs or the inverse of the PWMs
- The PWMs can be independently enabled in ACTIVE state. In all other states the PWMs are disabled.

8.12 LED modulator (LED1 and LED2)

The PCF50603 contains two LED modulators (LED1 and LED2), which can be selected as input for any of the GPO outputs. The LED modulator of the PCF50603 is used for the control of the indicator LEDs. They offer the following features:

- The LED driver can select eight different repetition periods
- Capable of generating eight different blinking patterns. The selected pattern is generated once per repetition period
- The LED can be used as a status indicator during the ACTIVE state or when a charger is connected.

8.13 General purpose outputs (GPO)

The PCF50603 contains three high current (100 mA) open-drain GPOs. They offer the following features:

- Each GPO can be configured as a constant LOW level, a high impedance, a LED modulator output, a PWM output or as the complementary PWM output \overline{PWM}
- The GPOs can sink 100 mA from any supply or battery voltage.

Controller for power supply and battery management

PCF50603

9 LIMITING VALUES

In accordance with the Absolute Maximum Rating System (IEC 60134).

SYMBOL	PARAMETER	CONDITIONS	MIN.	MAX.	UNIT
V _{BAT}	main battery voltage		-0.5	+6.5	V
V _{SAVE}	backup battery input voltage		-0.5	+6.5	V
V _{CHG}	charger input voltage		-0.5	+20	V
V _I	input voltage on any pin with respect to REFGND		-0.5	+6.5	V
I _I	input current at any input		-10	+10	mA
I _O	output current at any output		-10	+10	mA
P _{tot}	total power dissipation		-	2000	mW
T _{amb}	operating ambient temperature		-40	+85	°C
T _{stg}	storage temperature		-55	+150	°C
V _{esd}	electrostatic discharge voltage	HBM; note 1 pins SIMEN, IOD2VBAT, SIMD3VBAT, SIMRSCD_N, SIMCKCD, SIMIOCD, V _{BAT} , V _{SAVE} , CPVBAT, LPD1VBAT, REC1_N, SIMVCC, RF12VBAT, HCVBAT, REC2_N	-	±6000	V
		pin V _{CHG}	-	±4000	V
		other pins	-	±2000	V
		MM; note 2	-	±200	V

Notes

- Human Body Model: equivalent to discharging a 100 pF capacitor via a 1.5 kΩ resistor.
- Machine Model: equivalent to discharging a 200 pF capacitor via a 0 Ω resistor.

10 CHARACTERISTICS

V_{SS} = REFGND = GND = 0 V; T_{amb} = -40 °C to +85 °C; unless otherwise specified.

SYMBOL	PARAMETER	CONDITIONS	MIN.	TYP.	MAX.	UNIT
V _{BAT}	main battery input voltage		0	-	5.7	V
V _{SAVE}	backup battery input voltage		0	-	5.7	V
V _{CHG}	charger input voltage	DC	0	-	15.0	V
		rectified sine wave; 100 Hz to 120 Hz; note 1	0	-	20.0	V
V _{CHGMIN}	minimum charger voltage enabling MBC module		-	2.7	-	V
f _{CLKCCO}	high clock frequency	32 kHz clock available	3.42	3.6	3.78	MHz
D1 regulator						
V _O	output voltage		1.20	-	3.20	V
I _O	output current		-	-	150	mA

Controller for power supply and battery management

PCF50603

SYMBOL	PARAMETER	CONDITIONS	MIN.	TYP.	MAX.	UNIT
D3 regulator						
V_O	output voltage		1.20	–	3.20	V
I_O	output current		–	–	100	mA
HC regulator						
V_O	output voltage		2.60	–	3.20	V
I_O	output current	note 1	–	–	250	mA
SIM regulator						
V_O	output voltage		1.80	–	3.00	V
I_O	output current		–	–	20	mA
CP regulator						
V_O	output voltage		3.50	–	5.00	V
I_O	output current	note 2	–	–	75	mA
D2 regulator						
V_O	output voltage		1.20	–	3.20	V
I_O	output current		–	–	150	mA
IO regulator						
V_O	output voltage		1.20	–	3.20	V
I_O	output current		–	–	150	mA
LP regulator						
V_O	output voltage		1.20	–	3.20	V
I_O	output current		–	–	100	mA
RF1 regulator						
V_O	output voltage		2.60	–	3.00	V
I_O	output current		–	–	100	mA
RF2 regulator						
V_O	output voltage		2.60	–	3.00	V
I_O	output current		–	–	100	mA
MBGEN regulator						
V_O	output voltage		2.15	–	2.15	V
I_O	output current		–	–	1.5	mA

Notes

- Under specific conditions a nominal current of 300 mA can be delivered.
- Maximum current depends on the selected output voltage. At 3.50 V, 4.00 V and 4.50 V the maximum output current is 75 mA. At 5.00 V output voltage the maximum output current is 50 mA.

Controller for power supply and battery management

PCF50603

11 APPLICATION INFORMATION

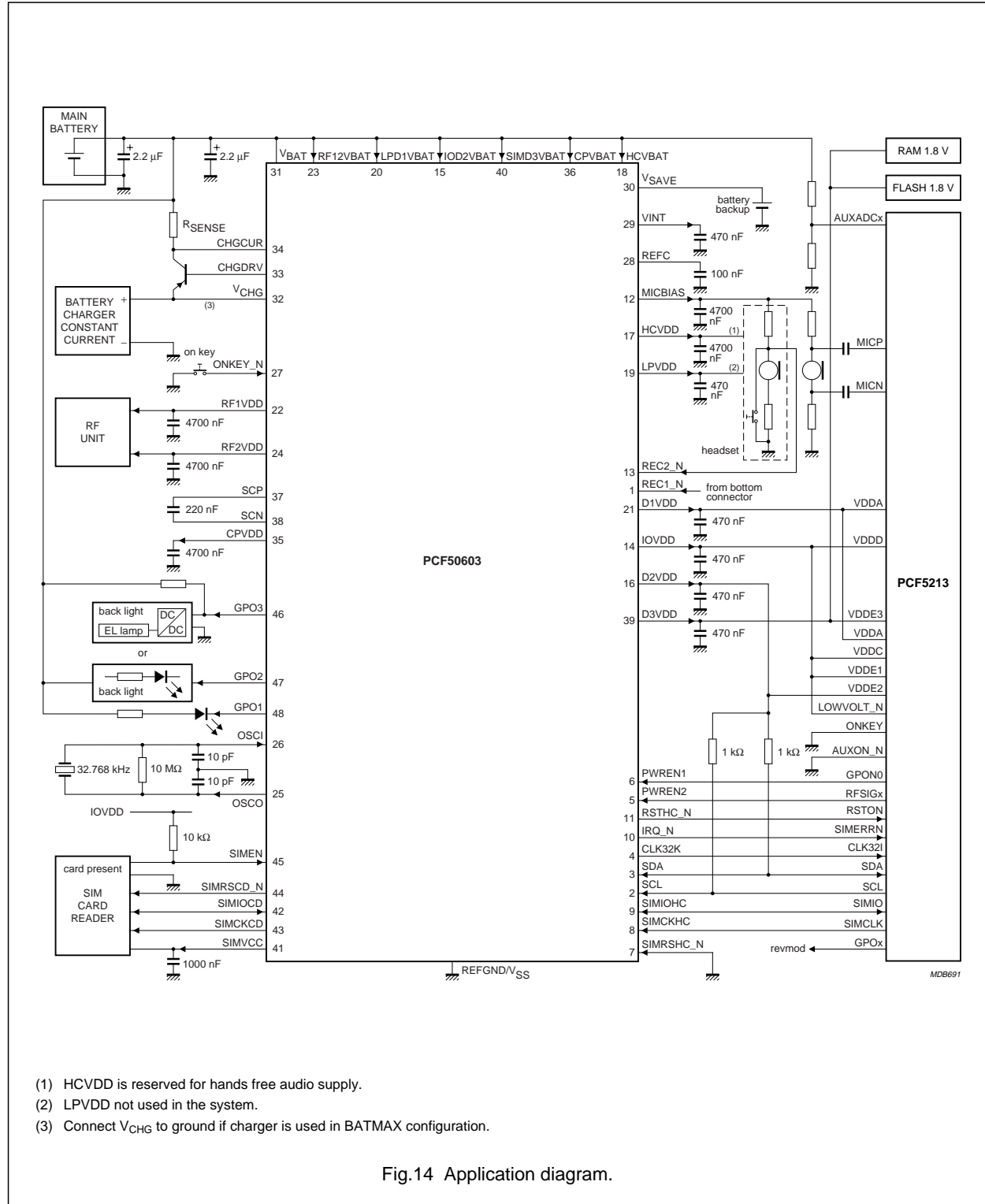

Controller for power supply and battery management

PCF50603

12 PACKAGE OUTLINE

HVQFN48: plastic thermal enhanced very thin quad flat package; no leads;
48 terminals; body 6 x 6 x 0.85 mm

SOT778-1

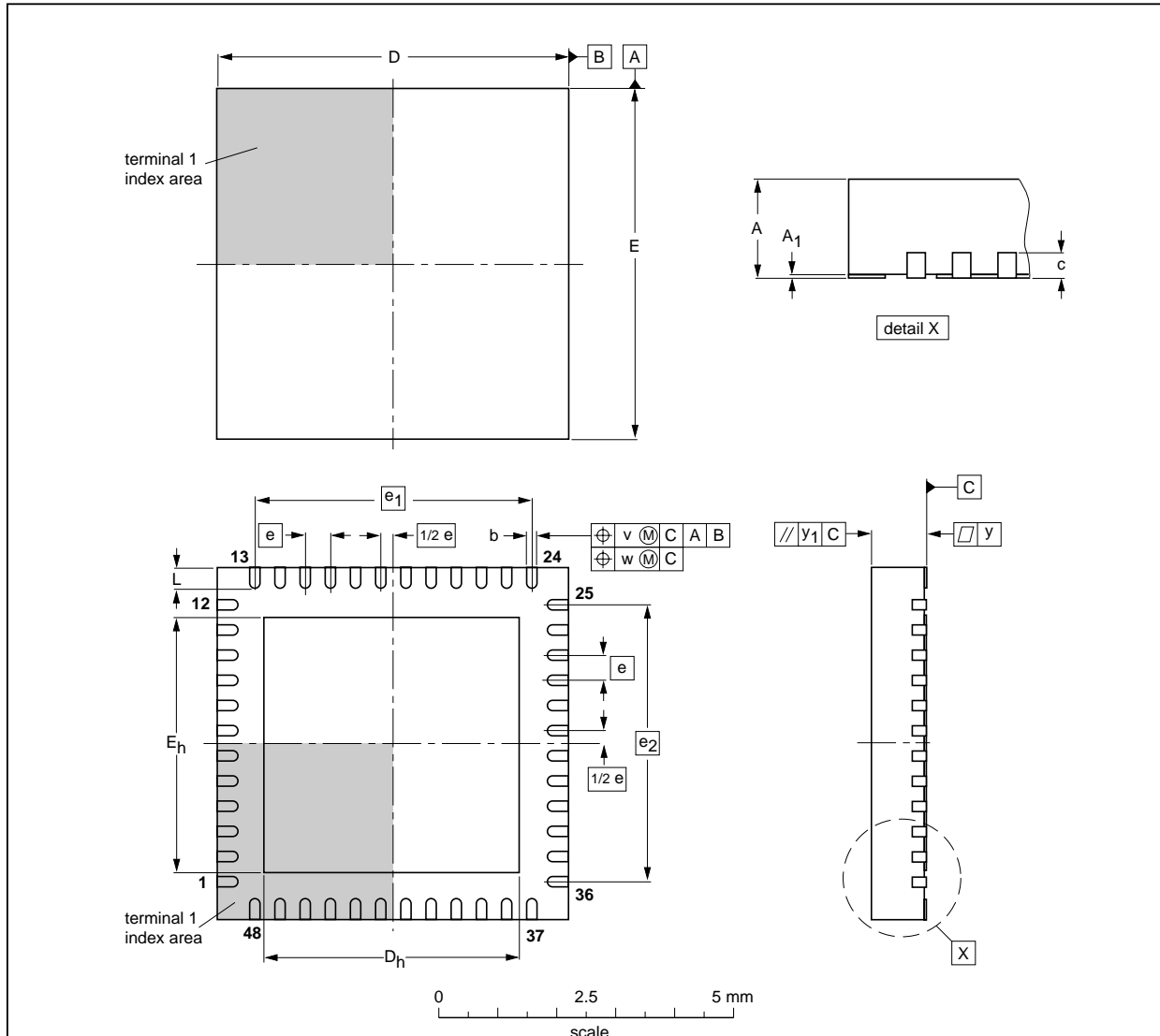

DIMENSIONS (mm are the original dimensions)

UNIT	A ⁽¹⁾ max.	A ₁	b	c	D ⁽¹⁾	D _h	E ⁽¹⁾	E _h	e	e ₁	e ₂	L	v	w	y	y ₁
mm	1	0.05 0.00	0.25 0.15	0.2	6.1 5.9	4.25 3.95	6.1 5.9	4.25 3.95	0.4	4.4	4.4	0.5 0.3	0.1	0.05	0.05	0.1

Note

1. Plastic or metal protrusions of 0.075 mm maximum per side are not included.

OUTLINE VERSION	REFERENCES				EUROPEAN PROJECTION	ISSUE DATE
	IEC	JEDEC	JEITA			
SOT778-1	---	---	---			02-07-05

Controller for power supply and battery management

PCF50603

13 SOLDERING

13.1 Introduction to soldering surface mount packages

This text gives a very brief insight to a complex technology. A more in-depth account of soldering ICs can be found in our "Data Handbook IC26; Integrated Circuit Packages" (document order number 9398 652 90011).

There is no soldering method that is ideal for all surface mount IC packages. Wave soldering can still be used for certain surface mount ICs, but it is not suitable for fine pitch SMDs. In these situations reflow soldering is recommended.

13.2 Reflow soldering

Reflow soldering requires solder paste (a suspension of fine solder particles, flux and binding agent) to be applied to the printed-circuit board by screen printing, stencilling or pressure-syringe dispensing before package placement. Driven by legislation and environmental forces the worldwide use of lead-free solder pastes is increasing.

Several methods exist for reflowing; for example, convection or convection/infrared heating in a conveyor type oven. Throughput times (preheating, soldering and cooling) vary between 100 and 200 seconds depending on heating method.

Typical reflow peak temperatures range from 215 to 270 °C depending on solder paste material. The top-surface temperature of the packages should preferably be kept:

- below 220 °C (SnPb process) or below 245 °C (Pb-free process)
 - for all BGA and SSOP-T packages
 - for packages with a thickness ≥ 2.5 mm
 - for packages with a thickness < 2.5 mm and a volume ≥ 350 mm³ so called thick/large packages.
- below 235 °C (SnPb process) or below 260 °C (Pb-free process) for packages with a thickness < 2.5 mm and a volume < 350 mm³ so called small/thin packages.

Moisture sensitivity precautions, as indicated on packing, must be respected at all times.

13.3 Wave soldering

Conventional single wave soldering is not recommended for surface mount devices (SMDs) or printed-circuit boards

with a high component density, as solder bridging and non-wetting can present major problems.

To overcome these problems the double-wave soldering method was specifically developed.

If wave soldering is used the following conditions must be observed for optimal results:

- Use a double-wave soldering method comprising a turbulent wave with high upward pressure followed by a smooth laminar wave.
- For packages with leads on two sides and a pitch (e):
 - larger than or equal to 1.27 mm, the footprint longitudinal axis is **preferred** to be parallel to the transport direction of the printed-circuit board;
 - smaller than 1.27 mm, the footprint longitudinal axis **must** be parallel to the transport direction of the printed-circuit board.

The footprint must incorporate solder thieves at the downstream end.

- For packages with leads on four sides, the footprint must be placed at a 45° angle to the transport direction of the printed-circuit board. The footprint must incorporate solder thieves downstream and at the side corners.

During placement and before soldering, the package must be fixed with a droplet of adhesive. The adhesive can be applied by screen printing, pin transfer or syringe dispensing. The package can be soldered after the adhesive is cured.

Typical dwell time of the leads in the wave ranges from 3 to 4 seconds at 250 °C or 265 °C, depending on solder material applied, SnPb or Pb-free respectively.

A mildly-activated flux will eliminate the need for removal of corrosive residues in most applications.

13.4 Manual soldering

Fix the component by first soldering two diagonally-opposite end leads. Use a low voltage (24 V or less) soldering iron applied to the flat part of the lead. Contact time must be limited to 10 seconds at up to 300 °C.

When using a dedicated tool, all other leads can be soldered in one operation within 2 to 5 seconds between 270 and 320 °C.

Controller for power supply and battery management

PCF50603

13.5 Suitability of surface mount IC packages for wave and reflow soldering methods

PACKAGE ⁽¹⁾	SOLDERING METHOD	
	WAVE	REFLOW ⁽²⁾
BGA, LBGA, LFBGA, SQFP, SSOP-T ⁽³⁾ , TFBGA, VFBGA	not suitable	suitable
DHVQFN, HBCC, HBGA, HLQFP, HSQFP, HSOP, HTQFP, HTSSOP, HVQFN, HVSON, SMS	not suitable ⁽⁴⁾	suitable
PLCC ⁽⁵⁾ , SO, SOJ	suitable	suitable
LQFP, QFP, TQFP	not recommended ⁽⁵⁾⁽⁶⁾	suitable
SSOP, TSSOP, VSO, VSSOP	not recommended ⁽⁷⁾	suitable
PMFP ⁽⁸⁾	not suitable	not suitable

Notes

- For more detailed information on the BGA packages refer to the “(LF)BGA Application Note” (AN01026); order a copy from your Philips Semiconductors sales office.
- All surface mount (SMD) packages are moisture sensitive. Depending upon the moisture content, the maximum temperature (with respect to time) and body size of the package, there is a risk that internal or external package cracks may occur due to vaporization of the moisture in them (the so called popcorn effect). For details, refer to the Drypack information in the “Data Handbook IC26; Integrated Circuit Packages; Section: Packing Methods”.
- These transparent plastic packages are extremely sensitive to reflow soldering conditions and must on no account be processed through more than one soldering cycle or subjected to infrared reflow soldering with peak temperature exceeding $217\text{ °C} \pm 10\text{ °C}$ measured in the atmosphere of the reflow oven. The package body peak temperature must be kept as low as possible.
- These packages are not suitable for wave soldering. On versions with the heatsink on the bottom side, the solder cannot penetrate between the printed-circuit board and the heatsink. On versions with the heatsink on the top side, the solder might be deposited on the heatsink surface.
- If wave soldering is considered, then the package must be placed at a 45° angle to the solder wave direction. The package footprint must incorporate solder thieves downstream and at the side corners.
- Wave soldering is suitable for LQFP, TQFP and QFP packages with a pitch (e) larger than 0.8 mm; it is definitely not suitable for packages with a pitch (e) equal to or smaller than 0.65 mm.
- Wave soldering is suitable for SSOP, TSSOP, VSO and VSSOP packages with a pitch (e) equal to or larger than 0.65 mm; it is definitely not suitable for packages with a pitch (e) equal to or smaller than 0.5 mm.
- Hot bar or manual soldering is suitable for PMFP packages.

Controller for power supply and battery management

PCF50603

14 DATA SHEET STATUS

LEVEL	DATA SHEET STATUS ⁽¹⁾	PRODUCT STATUS ⁽²⁾⁽³⁾	DEFINITION
I	Objective data	Development	This data sheet contains data from the objective specification for product development. Philips Semiconductors reserves the right to change the specification in any manner without notice.
II	Preliminary data	Qualification	This data sheet contains data from the preliminary specification. Supplementary data will be published at a later date. Philips Semiconductors reserves the right to change the specification without notice, in order to improve the design and supply the best possible product.
III	Product data	Production	This data sheet contains data from the product specification. Philips Semiconductors reserves the right to make changes at any time in order to improve the design, manufacturing and supply. Relevant changes will be communicated via a Customer Product/Process Change Notification (CPCN).

Notes

1. Please consult the most recently issued data sheet before initiating or completing a design.
2. The product status of the device(s) described in this data sheet may have changed since this data sheet was published. The latest information is available on the Internet at URL <http://www.semiconductors.philips.com>.
3. For data sheets describing multiple type numbers, the highest-level product status determines the data sheet status.

15 DEFINITIONS

Short-form specification — The data in a short-form specification is extracted from a full data sheet with the same type number and title. For detailed information see the relevant data sheet or data handbook.

Limiting values definition — Limiting values given are in accordance with the Absolute Maximum Rating System (IEC 60134). Stress above one or more of the limiting values may cause permanent damage to the device.

These are stress ratings only and operation of the device at these or at any other conditions above those given in the Characteristics sections of the specification is not implied. Exposure to limiting values for extended periods may affect device reliability.

Application information — Applications that are described herein for any of these products are for illustrative purposes only. Philips Semiconductors make no representation or warranty that such applications will be suitable for the specified use without further testing or modification.

16 DISCLAIMERS

Life support applications — These products are not designed for use in life support appliances, devices, or systems where malfunction of these products can reasonably be expected to result in personal injury. Philips Semiconductors customers using or selling these products for use in such applications do so at their own risk and agree to fully indemnify Philips Semiconductors for any damages resulting from such application.

Right to make changes — Philips Semiconductors reserves the right to make changes in the products - including circuits, standard cells, and/or software - described or contained herein in order to improve design and/or performance. When the product is in full production (status 'Production'), relevant changes will be communicated via a Customer Product/Process Change Notification (CPCN). Philips Semiconductors assumes no responsibility or liability for the use of any of these products, conveys no licence or title under any patent, copyright, or mask work right to these products, and makes no representations or warranties that these products are free from patent, copyright, or mask work right infringement, unless otherwise specified.

**Controller for power supply
and battery management**

PCF50603

17 PURCHASE OF PHILIPS I²C COMPONENTS

Purchase of Philips I²C components conveys a license under the Philips' I²C patent to use the components in the I²C system provided the system conforms to the I²C specification defined by Philips. This specification can be ordered using the code 9398 393 40011.

Philips Semiconductors – a worldwide company

Contact information

For additional information please visit <http://www.semiconductors.philips.com>. Fax: **+31 40 27 24825**

For sales offices addresses send e-mail to: sales.addresses@www.semiconductors.philips.com.

© Koninklijke Philips Electronics N.V. 2003

SCA75

All rights are reserved. Reproduction in whole or in part is prohibited without the prior written consent of the copyright owner.

The information presented in this document does not form part of any quotation or contract, is believed to be accurate and reliable and may be changed without notice. No liability will be accepted by the publisher for any consequence of its use. Publication thereof does not convey nor imply any license under patent- or other industrial or intellectual property rights.

Printed in The Netherlands

R54/01/pp28

Date of release: 2003 Oct 31

Document order number: 9397 750 11771

Let's make things better.

**Philips
Semiconductors**



PHILIPS