

Toshiba BiCD Integrated Circuit Silicon Monolithic

## TB7101F(T5L1.2,F) , TB7101F(T5L1.5,F) TB7101F(T5L1.8,F) , TB7101F(T5L2.5,F) TB7101F(T5L3.3,F)

### Step-down DC-DC Converter IC

The TB7101F is a single-chip step-down DC-DC converter IC. Equipped with a built-in high-speed and low on-resistance power MOSFET, and utilizing a synchronous rectifier circuit, this IC can achieve high efficiency.

#### Features

- Capable of high current drive ( $I_{OUT}$  = maximum of 1 A), using only a few external components.
- Operating voltage ( $V_{IN}$ ) range: 2.7 to 5.5 V.
- Fixed output voltage :  $V_{OUT}$  = 1.2V / 1.5V / 1.8V / 2.5V / 3.3V(typ.)
- High oscillation frequency of 1 MHz (typ.), making it possible to use small external components.
- Uses internal phase compensation, achieving high efficiency using only an inductor and two capacitors.
- Built-in current mode architecture with excellent fast load response.
- A small surface-mount type ceramic capacitor can be used as an output smoothing capacitor.
- Housed in a small surface-mount package (PS-8) with a low thermal resistance.
- Built-in undervoltage lock out (U.V.L.O), heatprotection, and overcurrent protection.

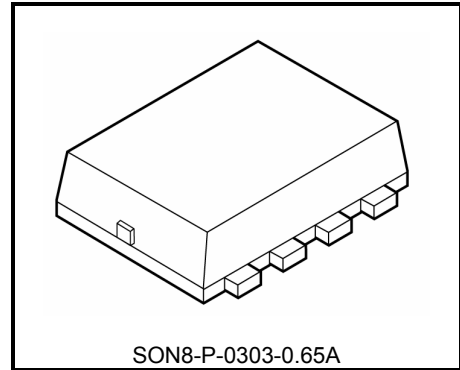

Weight : 0.017 g (typ.)

#### Marking (Note 1)/Pin Assignment

Type	Output voltage(V)	Type name
TB7101F(T5L1.2,F)	1.2	7101A
TB7101F(T5L1.5,F)	1.5	7101B
TB7101F(T5L1.8,F)	1.8	7101C
TB7101F(T5L2.5,F)	2.5	7101D
TB7101F(T5L3.3,F)	3.3	7101E

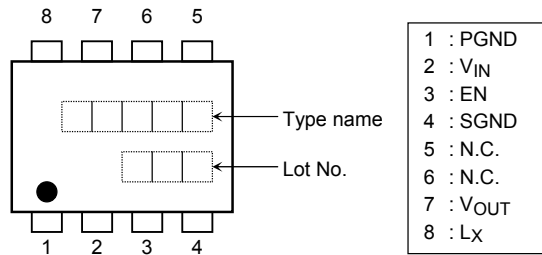

- 1 : PGND
- 2 :  $V_{IN}$
- 3 : EN
- 4 : SGND
- 5 : N.C.
- 6 : N.C.
- 7 :  $V_{OUT}$
- 8 : Lx

Note 1: ● on the lower left of the marking indicates Pin 1.

\* The Lot number comprises three numerals. The first numeral represents the last digit of the year of manufacture, and the following two digits indicate the week of manufacture, beginning with 01 and continuing to either 52 or 53.



Manufacturing week Code  
 (The first week of the year is 01, continuing up to 52 or 53)  
 Manufacturing year Code  
 (Last digit of the year of manufacture)

Due to its MOS structure, this product is sensitive to electrostatic discharge. Handle with care.

## How to Order

Product No.	Package Type and Capacity
TB7101F(T5L*.*,F)	Emboss Taping (3000pcs / reel )

## Block Diagram

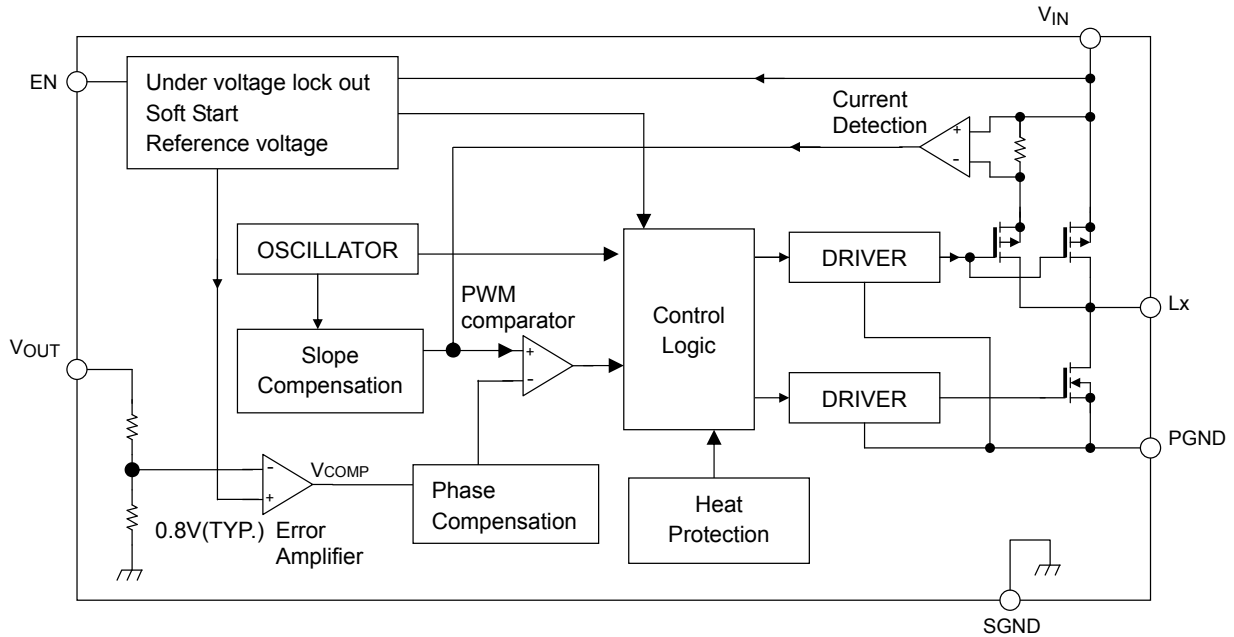

## Pin Descriptions

Pin No.	Pin Symbol	Pin Description
1	PGND	Power ground.
2	V <sub>IN</sub>	Input pin. This pin is placed in the standby state if V <sub>ENB</sub> = low. 1 μA or lower operating current.
3	EN	Enable pin. This pin is connected to the CMOS inverter. Applying 3.5 V or higher (@ V <sub>IN</sub> = 5 V) to this pin causes the internal circuit to start switching control.
4	SGND	Signal ground.
5	N.C.	No connection.
6	N.C.	No connection.
7	V <sub>OUT</sub>	Output voltage pin. Output voltage is set to 1.2V / 1.5V / 1.8V / 2.5V / 3.3V(typ.) internally.
8	Lx	Switching pin. This pin is connected to high-side pch MOS FET and low-side nch MOS FET.

## Timing Chart

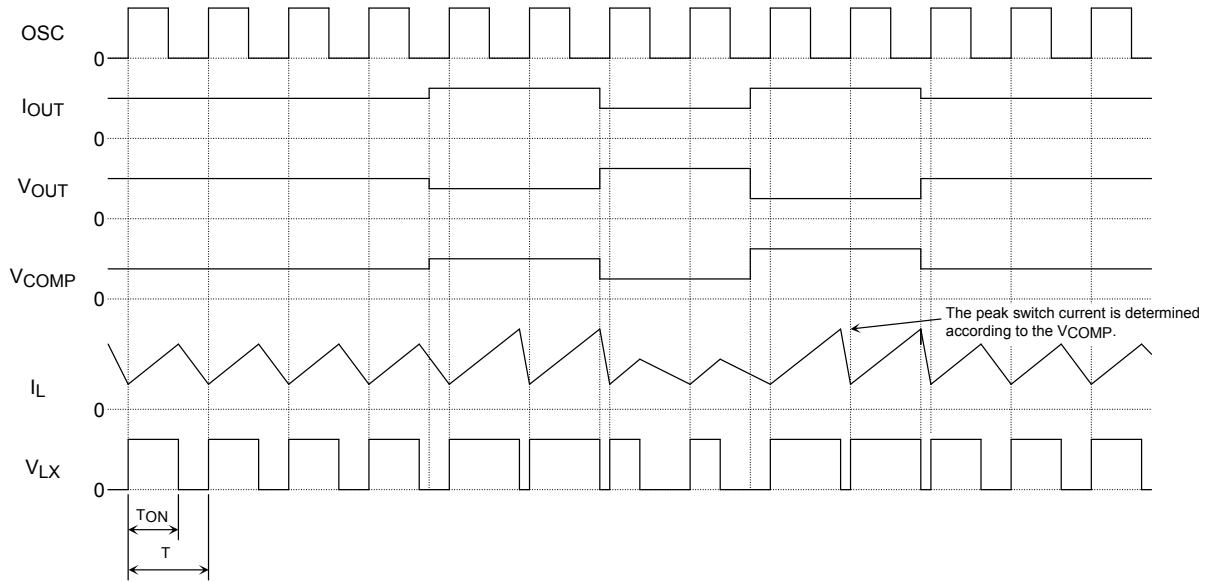

## Overheat state operation

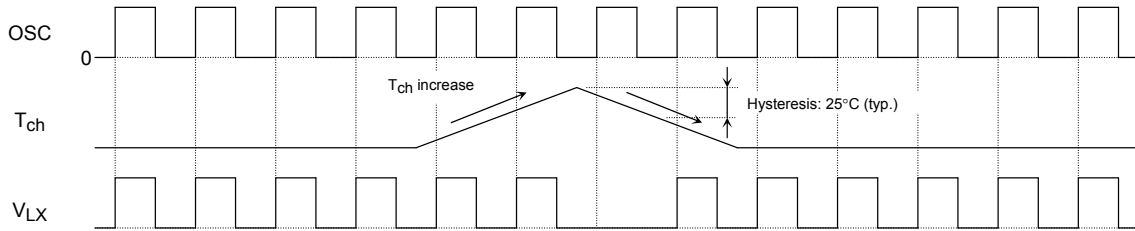

## Low Voltage operation

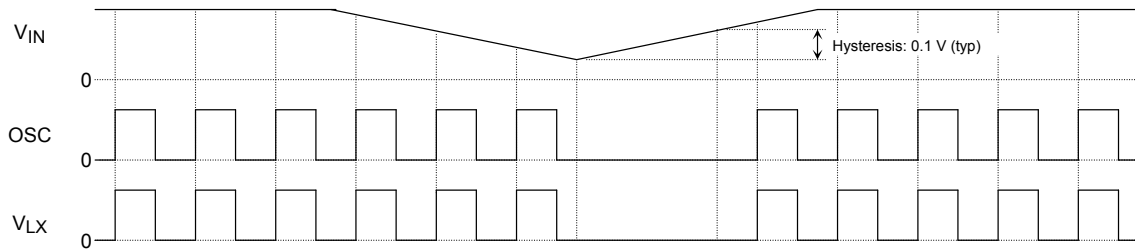

OSC : Internal oscillator output voltage  
 IOUT : Load current  
 VOUT: Output voltage  
 VCOMP: Output voltage of error amplifier  
 $I_L$  : Inductor current  
 VLX : Lx pin voltage  
 $V_{IN}$  : Input pin voltage  
 $T_{ch}$  : Channel temperature

## Absolute Maximum Ratings (Ta = 25°C)

Characteristics	Symbol	Rating	Unit
Input voltage	V <sub>IN</sub>	-0.3~6	V
Switch pin voltage	V <sub>LX</sub>	-0.3~6	V
Feedback pin voltage	V <sub>OUT</sub>	-0.3~6	V
Enable pin voltage	V <sub>EN</sub>	-0.3~6	V
Input-enable pin voltage	V <sub>EN</sub> -V <sub>IN</sub>	V <sub>EN</sub> -V <sub>IN</sub> <0.3	V
Power dissipation (Note 1)	P <sub>D</sub>	0.7	W
Operating temperature	T <sub>opr</sub>	-40~85	°C
Operating junction temperature	T <sub>jopr</sub>	-40~125	°C
Channel temperature	T <sub>ch</sub>	150	°C
Storage temperature	T <sub>stg</sub>	-55~150	°C

Note 1: Using continuously under heavy loads (e.g. the application of high temperature/current/voltage a significant change in temperature, etc.) may significantly reduce the reliability of this product even if the operating conditions (i.e. operating temperature/current/voltage, etc.) are within the absolute maximum ratings and the operating ranges.  
 Please consult the Toshiba Semiconductor Reliability Handbook ("Handling Precautions"/"Derating Concept and Methods") and individual reliability data (i.e. reliability test report and estimated failure rate, etc) when designing in order to ensure the appropriate reliability.

## Thermal Resistance Characteristic

Characteristics	Symbol	Max	Unit
Thermal resistance, channel and ambient	R <sub>th (ch-a)</sub>	178.6 (Note 2)	°C /W

(Note 2)

Glass epoxy board

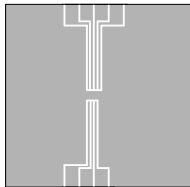

Material: FR-4  
 25.4 × 25.4 × 0.8  
 (Unit: mm)

## Electrical Characteristics (unless otherwise specified: Tj = 25°C and V<sub>IN</sub> = 2.7 to 5.5 V)

### ●TB7101F(T5L1.2,F)

Characteristics	Symbol	Test circuit	Test condition	Min	Typ.	Max	Unit
Operating supply voltage	V <sub>IN(OPR)</sub>	-	-	2.7	-	5.5	V
Operating current	I <sub>IN(1)</sub>	-	V <sub>IN</sub> = 5V, V <sub>EN</sub> = 5V, V <sub>OUT</sub> = 5V	-	0.68	0.9	mA
	I <sub>IN(2)</sub>	-	V <sub>IN</sub> = 2.7V, V <sub>EN</sub> = 2.7V, V <sub>OUT</sub> =2.7V	-	0.55	0.69	mA
Standby current	I <sub>IN(STBY)</sub>	-	V <sub>IN</sub> = 5V, V <sub>EN</sub> = 0V, V <sub>OUT</sub> = 0V	-	-	1	μA
Enable pin threshold voltage	V <sub>IH(EN)(1)</sub>	-	V <sub>IN</sub> = 5V	3.5	-	-	V
	V <sub>IH(EN)(2)</sub>	-	V <sub>IN</sub> = 2.7V	1.89	-	-	V
	V <sub>IL(EN)(1)</sub>	-	V <sub>IN</sub> = 5V	-	-	1.5	V
	V <sub>IL(EN)(2)</sub>	-	V <sub>IN</sub> = 2.7V	-	-	0.81	V
Enable pin input current	I <sub>IH(EN)(1)</sub>	-	V <sub>IN</sub> = 5V, V <sub>EN</sub> = 5V	7.6	-	12.4	μA
	I <sub>IH(EN)(2)</sub>	-	V <sub>IN</sub> = 2.7V, V <sub>EN</sub> = 2.7V	4.1	-	6.7	μA
Output voltage	V <sub>OUT(1)</sub>	-	V <sub>IN</sub> = 5V, V <sub>EN</sub> = 5V I <sub>OUT</sub> =100mA	1.164	1.2	1.236	V
	V <sub>OUT(2)</sub>	-	V <sub>IN</sub> =2.7V, V <sub>EN</sub> = 2.7V, I <sub>OUT</sub> =100mA	1.164	1.2	1.236	V
Line regulation	LINE REG	-	V <sub>IN</sub> = V <sub>EN</sub> = 2.7V~5.5V I <sub>OUT</sub> =100mA	-	-	14.5	mV
Load regulation	LOAD REG	-	V <sub>IN</sub> =5V I <sub>OUT</sub> = 100mA~500mA	-	-	14.5	mV
High-side on-state resistance	R <sub>DS(ON)(H)</sub>	-	V <sub>IN</sub> = 5V, V <sub>EN</sub> = 5V, I <sub>LX</sub> = 0.5A	-	0.27	-	Ω
Low-side on-state resistance	R <sub>DS(ON)(L)</sub>	-	V <sub>IN</sub> = 5V, V <sub>EN</sub> = 5V, I <sub>LX</sub> = 0.5A	-	0.27	-	Ω
High-side leakage current	I <sub>LEAK(H)</sub>	-	V <sub>IN</sub> = 5V, V <sub>EN</sub> = 0V, V <sub>LX</sub> = 0V	-	-	1	μA
Low-side leakage current	I <sub>LEAK(L)</sub>	-	V <sub>IN</sub> = 5V, V <sub>EN</sub> = 0V, V <sub>LX</sub> = 5V	-	-	1	μA
Oscillation frequency	f <sub>OSC(1)</sub>	-	V <sub>IN</sub> = 5V, V <sub>EN</sub> = 5V	0.85	1	1.15	MHz
	f <sub>OSC(2)</sub>	-	V <sub>IN</sub> = 2.7V, V <sub>EN</sub> = 2.7V	0.85	1	1.15	MHz
Soft start time	t <sub>SS(1)</sub>	-	V <sub>IN</sub> =5V , V <sub>EN</sub> =5V, (no load)	1	2	-	ms
	t <sub>SS(2)</sub>	-	V <sub>IN</sub> = 2.7V, V <sub>EN</sub> = 2.7V, (no load)	1.4	2.4	-	ms
Undervoltage protection	Detection	V <sub>UV</sub>	-	2.2	2.5	2.7	V
	Hysteresis	ΔV <sub>UV</sub>	-	-	0.1	-	V

## Protection function (reference data)

### ●TB7101F(T5L1.2,F)

Overheat protection	Detection	T <sub>SD</sub>	-	-	-	160	-	°C
	Hysteresis	ΔT <sub>SD</sub>	-	-	-	20	-	°C

## Electrical Characteristics (unless otherwise specified: Tj = 25°C and V<sub>IN</sub> = 2.7 to 5.5 V)

### ●TB7101F(T5L1.5,F)

Characteristics	Symbol	Test circuit	Test condition	Min	Typ.	Max	Unit
Operating supply voltage	V <sub>IN(OPR)</sub>	-	-	2.7	-	5.5	V
Operating current	I <sub>IN(1)</sub>	-	V <sub>IN</sub> = 5V, V <sub>EN</sub> = 5V, V <sub>OUT</sub> = 5V	-	0.68	0.9	mA
	I <sub>IN(2)</sub>	-	V <sub>IN</sub> = 2.7V, V <sub>EN</sub> = 2.7V, V <sub>OUT</sub> =2.7V	-	0.55	0.69	mA
Standby current	I <sub>IN(STBY)</sub>	-	V <sub>IN</sub> = 5V, V <sub>EN</sub> = 0V, V <sub>OUT</sub> = 0V	-	-	1	μA
Enable pin threshold voltage	V <sub>IH(EN)(1)</sub>	-	V <sub>IN</sub> = 5V	3.5	-	-	V
	V <sub>IH(EN)(2)</sub>	-	V <sub>IN</sub> = 2.7V	1.89	-	-	V
	V <sub>IL(EN)(1)</sub>	-	V <sub>IN</sub> = 5V	-	-	1.5	V
	V <sub>IL(EN)(2)</sub>	-	V <sub>IN</sub> = 2.7V	-	-	0.81	V
Enable pin input current	I <sub>IH(EN)(1)</sub>	-	V <sub>IN</sub> = 5V, V <sub>EN</sub> = 5V	7.6	-	12.4	μA
	I <sub>IH(EN)(2)</sub>	-	V <sub>IN</sub> = 2.7V, V <sub>EN</sub> = 2.7V	4.1	-	6.7	μA
Output voltage	V <sub>OUT(1)</sub>	-	V <sub>IN</sub> = 5V, V <sub>EN</sub> = 5V I <sub>OUT</sub> =100mA	1.455	1.5	1.545	V
	V <sub>OUT(2)</sub>	-	V <sub>IN</sub> =2.7V, V <sub>EN</sub> = 2.7V, I <sub>OUT</sub> =100mA	1.455	1.5	1.545	V
Line regulation	LINE REG	-	V <sub>IN</sub> = V <sub>EN</sub> = 2.7V~5.5V I <sub>OUT</sub> =100mA	-	-	18	mV
Load regulation	LOAD REG	-	V <sub>IN</sub> =5V I <sub>OUT</sub> = 100mA~500mA	-	-	18	mV
High-side on-state resistance	R <sub>DS(ON)(H)</sub>	-	V <sub>IN</sub> = 5V, V <sub>EN</sub> = 5V, I <sub>LX</sub> = 0.5A	-	0.27	-	Ω
Low-side on-state resistance	R <sub>DS(ON)(L)</sub>	-	V <sub>IN</sub> = 5V, V <sub>EN</sub> = 5V, I <sub>LX</sub> = 0.5A	-	0.27	-	Ω
High-side leakage current	I <sub>LEAK(H)</sub>	-	V <sub>IN</sub> = 5V, V <sub>EN</sub> = 0V, V <sub>LX</sub> = 0V	-	-	1	μA
Low-side leakage current	I <sub>LEAK(L)</sub>	-	V <sub>IN</sub> = 5V, V <sub>EN</sub> = 0V, V <sub>LX</sub> = 5V	-	-	1	μA
Oscillation frequency	f <sub>OSC(1)</sub>	-	V <sub>IN</sub> = 5V, V <sub>EN</sub> = 5V	0.85	1	1.15	MHz
	f <sub>OSC(2)</sub>	-	V <sub>IN</sub> = 2.7V, V <sub>EN</sub> = 2.7V	0.85	1	1.15	MHz
Soft start time	t <sub>SS(1)</sub>	-	V <sub>IN</sub> =5V , V <sub>EN</sub> =5V, (no load)	1	2	-	ms
	t <sub>SS(2)</sub>	-	V <sub>IN</sub> = 2.7V, V <sub>EN</sub> = 2.7V, (no load)	1.4	2.4	-	ms
Undervoltage protection	Detection	V <sub>UV</sub>	-	2.2	2.5	2.7	V
	Hysteresis	ΔV <sub>UV</sub>	-	-	0.1	-	V

## Protection function (reference data)

### ●TB7101F(T5L1.5,F)

Overheat protection	Detection	T <sub>SD</sub>	-	-	-	160	-	°C
	Hysteresis	ΔT <sub>SD</sub>	-	-	-	20	-	°C

## Electrical Characteristics (unless otherwise specified: T<sub>j</sub> = 25°C and V<sub>IN</sub> = 2.8 to 5.5 V)

### ●TB7101F(T5L1.8,F)

Characteristics	Symbol	Test circuit	Test condition	Min	Typ.	Max	Unit
Operating supply voltage	V <sub>IN(OPR)</sub>	-	-	2.8	-	5.5	V
Operating current	I <sub>IN(1)</sub>	-	V <sub>IN</sub> = 5V, V <sub>EN</sub> = 5V, V <sub>OUT</sub> = 5V	-	0.68	0.9	mA
	I <sub>IN(2)</sub>	-	V <sub>IN</sub> = 2.8V, V <sub>EN</sub> = 2.8V, V <sub>OUT</sub> =2.8V	-	0.55	0.69	mA
Standby current	I <sub>IN(STBY)</sub>	-	V <sub>IN</sub> = 5V, V <sub>EN</sub> = 0V, V <sub>OUT</sub> = 0V	-	-	1	μA
Enable pin threshold voltage	V <sub>IH(EN)(1)</sub>	-	V <sub>IN</sub> = 5V	3.5	-	-	V
	V <sub>IH(EN)(2)</sub>	-	V <sub>IN</sub> = 2.8V	1.89	-	-	V
	V <sub>IL(EN)(1)</sub>	-	V <sub>IN</sub> = 5V	-	-	1.5	V
	V <sub>IL(EN)(2)</sub>	-	V <sub>IN</sub> = 2.8V	-	-	0.81	V
Enable pin input current	I <sub>IH(EN)(1)</sub>	-	V <sub>IN</sub> = 5V, V <sub>EN</sub> = 5V	7.6	-	12.4	μA
	I <sub>IH(EN)(2)</sub>	-	V <sub>IN</sub> = 2.8V, V <sub>EN</sub> = 2.8V	4.26	-	6.94	μA
Output voltage	V <sub>OUT(1)</sub>	-	V <sub>IN</sub> = 5V, V <sub>EN</sub> = 5V I <sub>OUT</sub> =100mA	1.746	1.8	1.854	V
	V <sub>OUT(2)</sub>	-	V <sub>IN</sub> =2.8V, V <sub>EN</sub> = 2.8V, I <sub>OUT</sub> =100mA	1.746	1.8	1.854	V
Line regulation	LINE REG	-	V <sub>IN</sub> = V <sub>EN</sub> = 2.8V~5.5V I <sub>OUT</sub> =100mA	-	-	14.5	mV
Load regulation	LOAD REG	-	V <sub>IN</sub> =5V I <sub>OUT</sub> = 100mA~500mA	-	-	14.5	mV
High-side on-state resistance	R <sub>DS(ON)(H)</sub>	-	V <sub>IN</sub> = 5V, V <sub>EN</sub> = 5V, I <sub>LX</sub> = 0.5A	-	0.27	-	Ω
Low-side on-state resistance	R <sub>DS(ON)(L)</sub>	-	V <sub>IN</sub> = 5V, V <sub>EN</sub> = 5V, I <sub>LX</sub> = 0.5A	-	0.27	-	Ω
High-side leakage current	I <sub>LEAK(H)</sub>	-	V <sub>IN</sub> = 5V, V <sub>EN</sub> = 0V, V <sub>LX</sub> = 0V	-	-	1	μA
Low-side leakage current	I <sub>LEAK(L)</sub>	-	V <sub>IN</sub> = 5V, V <sub>EN</sub> = 0V, V <sub>LX</sub> = 5V	-	-	1	μA
Oscillation frequency	f <sub>OSC(1)</sub>	-	V <sub>IN</sub> = 5V, V <sub>EN</sub> = 5V	0.85	1	1.15	MHz
	f <sub>OSC(2)</sub>	-	V <sub>IN</sub> = 2.8V, V <sub>EN</sub> = 2.8V	0.85	1	1.15	MHz
Soft start time	t <sub>SS(1)</sub>	-	V <sub>IN</sub> =5V , V <sub>EN</sub> =5V, (no load)	1	2	-	ms
	t <sub>SS(2)</sub>	-	V <sub>IN</sub> = 2.8V, V <sub>EN</sub> = 2.8V, (no load)	1.4	2.4	-	ms
Undervoltage protection	Detection	V <sub>UV</sub>	-	2.2	2.5	2.7	V
	Hysteresis	ΔV <sub>UV</sub>	-	-	0.1	-	V

## Protection function (reference data)

### ●TB7101F(T5L1.8,F)

Overheat protection	Detection	T <sub>SD</sub>	-	-	-	160	-	°C
	Hysteresis	ΔT <sub>SD</sub>	-	-	-	20	-	°C

## Electrical Characteristics (unless otherwise specified: Tj = 25°C and V<sub>IN</sub> = 3.5 to 5.5 V)

### ●TB7101F(T5L2.5,F)

Characteristics	Symbol	Test circuit	Test condition	Min	Typ.	Max	Unit
Operating supply voltage	V <sub>IN(OPR)</sub>	-	-	3.5	-	5.5	V
Operating current	I <sub>IN(1)</sub>	-	V <sub>IN</sub> = 5V, V <sub>EN</sub> = 5V, V <sub>OUT</sub> = 5V	-	0.68	0.9	mA
	I <sub>IN(2)</sub>	-	V <sub>IN</sub> = 3.5V, V <sub>EN</sub> = 3.5V, V <sub>OUT</sub> =3.5V	-	0.55	0.705	mA
Standby current	I <sub>IN(STBY)</sub>	-	V <sub>IN</sub> = 5V, V <sub>EN</sub> = 0V, V <sub>OUT</sub> = 0V	-	-	1	μA
Enable pin threshold voltage	V <sub>IH(EN)(1)</sub>	-	V <sub>IN</sub> = 5V	3.5	-	-	V
	V <sub>IH(EN)(2)</sub>	-	V <sub>IN</sub> = 3.5V	2.45	-	-	V
	V <sub>IL(EN)(1)</sub>	-	V <sub>IN</sub> = 5V	-	-	1.5	V
	V <sub>IL(EN)(2)</sub>	-	V <sub>IN</sub> = 3.5V	-	-	1.05	V
Enable pin input current	I <sub>IH(EN)(1)</sub>	-	V <sub>IN</sub> = 5V, V <sub>EN</sub> = 5V	7.6	-	12.4	μA
	I <sub>IH(EN)(2)</sub>	-	V <sub>IN</sub> = 2.7V, V <sub>EN</sub> = 2.7V	5.32	-	8.68	μA
Output voltage	V <sub>OUT(1)</sub>	-	V <sub>IN</sub> = 5V, V <sub>EN</sub> = 5V I <sub>OUT</sub> =100mA	2.425	2.5	2.575	V
	V <sub>OUT(2)</sub>	-	V <sub>IN</sub> =3.5V, V <sub>EN</sub> = 3.5V, I <sub>OUT</sub> =100mA	2.425	2.5	2.575	V
Line regulation	LINE REG	-	V <sub>IN</sub> = V <sub>EN</sub> = 3.5V~5.5V I <sub>OUT</sub> =100mA	-	-	30	mV
Load regulation	LOAD REG	-	V <sub>IN</sub> =5V I <sub>OUT</sub> = 100mA~500mA	-	-	30	mV
High-side on-state resistance	R <sub>DS(ON)(H)</sub>	-	V <sub>IN</sub> = 5V, V <sub>EN</sub> = 5V, I <sub>LX</sub> = 0.5A	-	0.27	-	Ω
Low-side on-state resistance	R <sub>DS(ON)(L)</sub>	-	V <sub>IN</sub> = 5V, V <sub>EN</sub> = 5V, I <sub>LX</sub> = 0.5A	-	0.27	-	Ω
High-side leakage current	I <sub>LEAK(H)</sub>	-	V <sub>IN</sub> = 5V, V <sub>EN</sub> = 0V, V <sub>LX</sub> = 0V	-	-	1	μA
Low-side leakage current	I <sub>LEAK(L)</sub>	-	V <sub>IN</sub> = 5V, V <sub>EN</sub> = 0V, V <sub>LX</sub> = 5V	-	-	1	μA
Oscillation frequency	f <sub>OSC(1)</sub>	-	V <sub>IN</sub> = 5V, V <sub>EN</sub> = 5V	0.85	1	1.15	MHz
	f <sub>OSC(2)</sub>	-	V <sub>IN</sub> = 3.5V, V <sub>EN</sub> = 3.5V	0.85	1	1.15	MHz
Soft start time	t <sub>SS(1)</sub>	-	V <sub>IN</sub> =5V , V <sub>EN</sub> =5V, (no load)	1	2	-	ms
	t <sub>SS(2)</sub>	-	V <sub>IN</sub> =3.5V , V <sub>EN</sub> =3.5V, (no load)	1.3	2.4	-	ms
Undervoltage protection	Detection	V <sub>UV</sub>	-	2.2	2.5	2.7	V
	Hysteresis	ΔV <sub>UV</sub>	-	-	0.1	-	V

## Protection function (reference data)

### ●TB7101F(T5L2.5F)

Overheat protection	Detection	T <sub>SD</sub>	-	-	-	160	-	°C
	Hysteresis	ΔT <sub>SD</sub>	-	-	-	20	-	°C



## Electrical Characteristics (unless otherwise specified: Tj = 25°C and V<sub>IN</sub> = 4.3 to 5.5 V)

### ●TB7101F(T5L3.3,F)

Characteristics	Symbol	Test circuit	Test condition	Min	Typ.	Max	Unit
Operating supply voltage	V <sub>IN(OPR)</sub>	-	-	4.3	-	5.5	V
Operating current	I <sub>IN(1)</sub>	-	V <sub>IN</sub> = 5V, V <sub>EN</sub> = 5V, V <sub>OUT</sub> = 5V	-	0.68	0.9	mA
	I <sub>IN(2)</sub>	-	V <sub>IN</sub> = 4.3V, V <sub>EN</sub> = 4.3V, V <sub>OUT</sub> =4.3V	-	-	0.775	mA
Standby current	I <sub>IN(STBY)</sub>	-	V <sub>IN</sub> = 5V, V <sub>EN</sub> = 0V, V <sub>OUT</sub> = 0V	-	-	1	μA
Enable pin threshold voltage	V <sub>IH(EN)(1)</sub>	-	V <sub>IN</sub> = 5V	3.5	-	-	V
	V <sub>IH(EN)(2)</sub>	-	V <sub>IN</sub> = 4.3V	3.01	-	-	V
	V <sub>IL(EN)(1)</sub>	-	V <sub>IN</sub> = 5V	-	-	1.5	V
	V <sub>IL(EN)(2)</sub>	-	V <sub>IN</sub> =4.3V	-	-	1.29	V
Enable pin input current	I <sub>IH(EN)(1)</sub>	-	V <sub>IN</sub> = 5V, V <sub>EN</sub> = 5V	7.6	-	12.4	μA
	I <sub>IH(EN)(2)</sub>	-	V <sub>IN</sub> = 2.7V, V <sub>EN</sub> = 2.7V	6.54	-	10.66	μA
Output voltage	V <sub>OUT(1)</sub>	-	V <sub>IN</sub> = 5V, V <sub>EN</sub> = 5V I <sub>OUT</sub> =100mA	1.164	1.2	1.236	V
	V <sub>OUT(2)</sub>	-	V <sub>IN</sub> =4.3V, V <sub>EN</sub> = 4.3V, I <sub>OUT</sub> =100mA	1.164	1.2	1.236	V
Line regulation	LINE REG	-	V <sub>IN</sub> = V <sub>EN</sub> = 4.3V~5.5V I <sub>OUT</sub> =100mA	-	-	40	mV
Load regulation	LOAD REG	-	V <sub>IN</sub> =5V I <sub>OUT</sub> = 100mA~500mA	-	-	40	mV
High-side on-state resistance	R <sub>DS(ON)(H)</sub>	-	V <sub>IN</sub> = 5V, V <sub>EN</sub> = 5V, I <sub>LX</sub> = 0.5A	-	0.27	-	Ω
Low-side on-state resistance	R <sub>DS(ON)(L)</sub>	-	V <sub>IN</sub> = 5V, V <sub>EN</sub> = 5V, I <sub>LX</sub> = 0.5A	-	0.27	-	Ω
High-side leakage current	I <sub>LEAK(H)</sub>	-	V <sub>IN</sub> = 5V, V <sub>EN</sub> = 0V, V <sub>LX</sub> = 0V	-	-	1	μA
Low-side leakage current	I <sub>LEAK(L)</sub>	-	V <sub>IN</sub> = 5V, V <sub>EN</sub> = 0V, V <sub>LX</sub> = 5V	-	-	1	μA
Oscillation frequency	f <sub>OSC(1)</sub>	-	V <sub>IN</sub> = 5V, V <sub>EN</sub> = 5V	0.85	1	1.15	MHz
	f <sub>OSC(2)</sub>	-	V <sub>IN</sub> = 4.3V, V <sub>EN</sub> = 4.3V	0.85	1	1.15	MHz
Soft start time	t <sub>SS(1)</sub>	-	V <sub>IN</sub> =5V , V <sub>EN</sub> =5V, (no load)	1	2	-	ms
	t <sub>SS(2)</sub>	-	V <sub>IN</sub> =4.3V , V <sub>EN</sub> =4.3V, (no load)	1.2	2.4	-	ms
Undervoltage protection	Detection	V <sub>UV</sub>	-	2.2	2.5	2.7	V
	Hysteresis	ΔV <sub>UV</sub>	-	-	0.1	-	V

## Protection function (reference data)

### ●TB7101F(T5L3.3,F)

Overheat protection	Detection	T <sub>SD</sub>	-	-	-	160	-	°C
	Hysteresis	ΔT <sub>SD</sub>	-	-	-	20	-	°C



$$L = \frac{V_{IN} - V_{OUT}}{f_{OSC} \cdot \Delta I_L} \cdot \frac{V_{OUT}}{V_{IN}}$$

$$= \frac{5V - 3.3V}{1MHz \cdot 300mA} \cdot \frac{3.3V}{5V}$$

$$= 3.7 \mu H$$

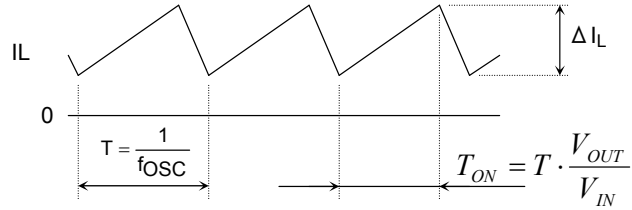

Figure 2: Inductor current waveform

## Output capacitor

The capacitance of the output ceramic capacitor is greatly affected by temperature. Select a product whose temperature characteristics (such as B-characteristic) are excellent. The capacitance value should be to more than 10 $\mu$ F, and set to an optimum value by, for example, enlarging the output capacitor when there is instability under use conditions ,or when there is a large ripple voltage or drop in output voltage under heavy loads. Ceramic capacitors can be used to achieve low output ripple, though it is more difficult to achieve phase compensation with ceramic capacitors because the equivalent series resistance (ESR) of ceramic capacitors is lower. For this reason, perform a careful evaluation when using ceramic capacitors.

## Precautions

- Please select parts after confirming the actual operation in the customer set and considering the input voltage the output voltage, the output current, the temperature, the characteristics or the kind of capacitor, and the inductor.
- If the voltage between the input and output is low, the influence of the on-state voltage of the switch power MOSFET is greater, causing the voltage across the inductor to decrease. For this reason, it may become impossible for the required inductor current to flow, resulting in lower performance or unstable operation of the DC-DC converter. As a rough standard, keep the input-output voltage potential difference at or above 1 V, taking the on-state voltage of the power MOSFET into consideration.
- The lowest output voltage that can be set is 0.8 V (typ.).
- There is an antistatic diode between the ENB and VIN pins. The voltage between the ENB and VIN pins should satisfy the rating  $V_{ENB} - V_{IN} < 0.3$  V
- If operation becomes unstable due to switching noise under a heavy load, please mount a by-pass capacitor  $C_{CC}$  between the SGND pin and the VIN pin.

## Characteristic data

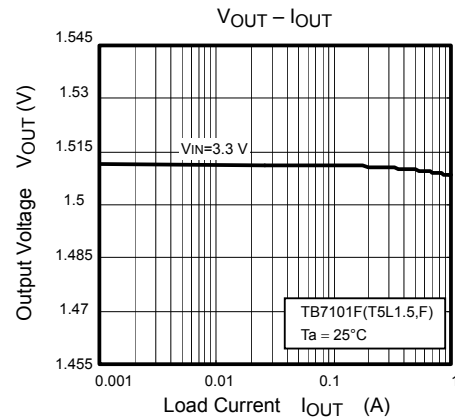
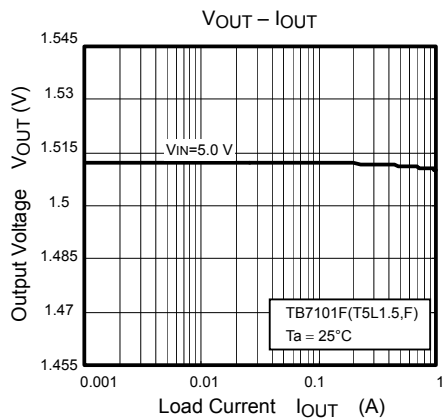
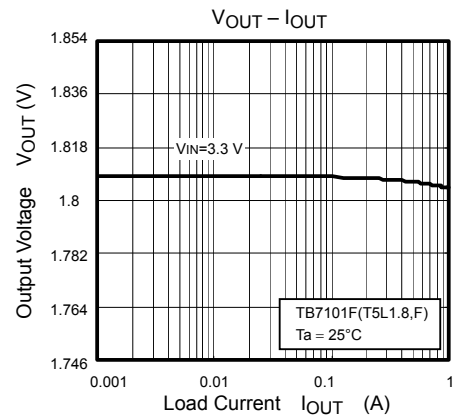
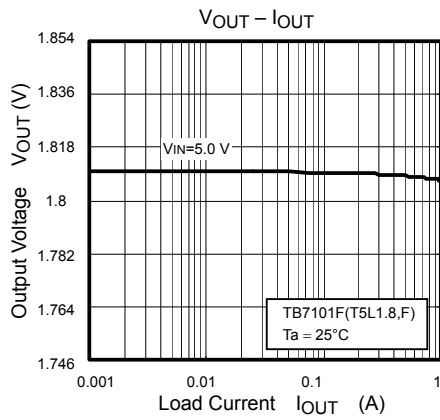
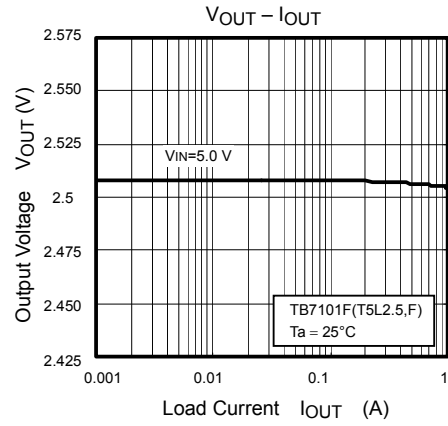
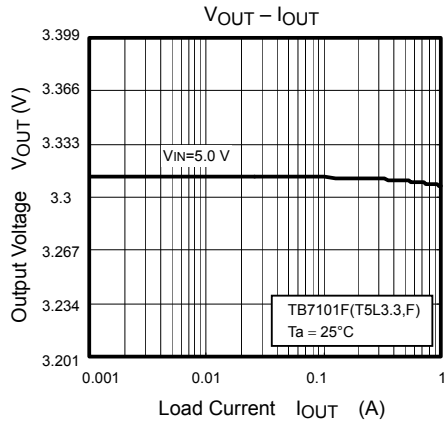

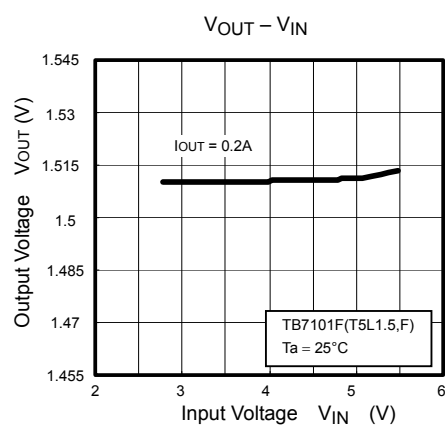
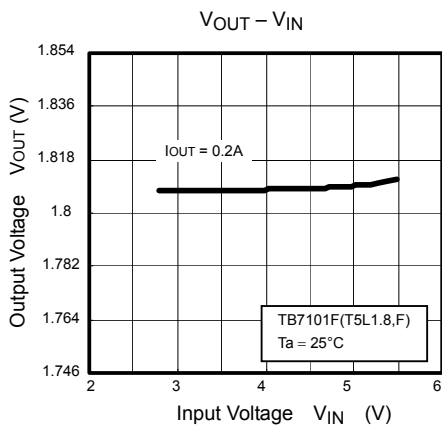
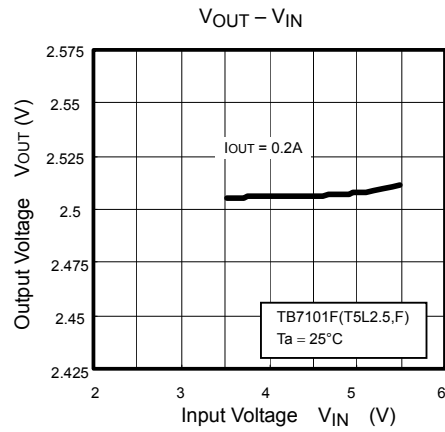
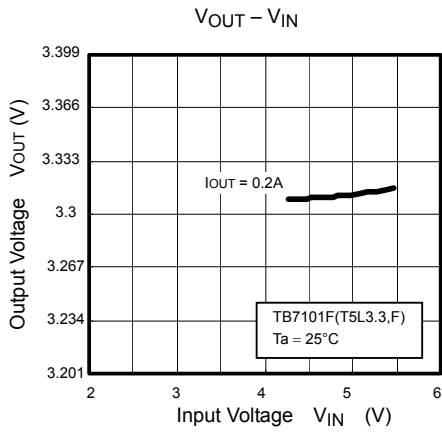
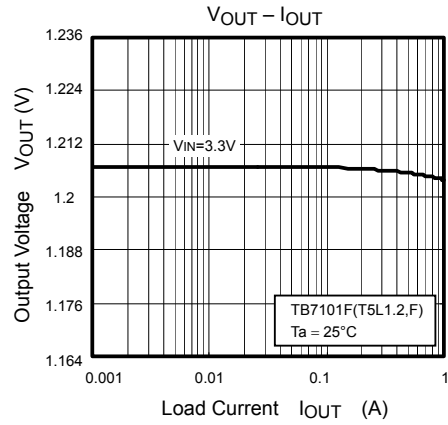
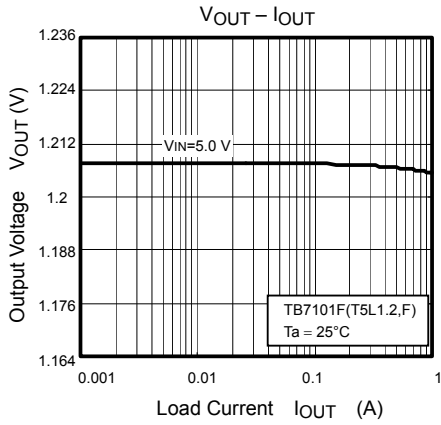

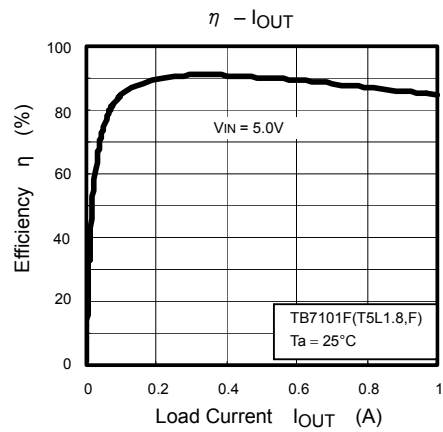
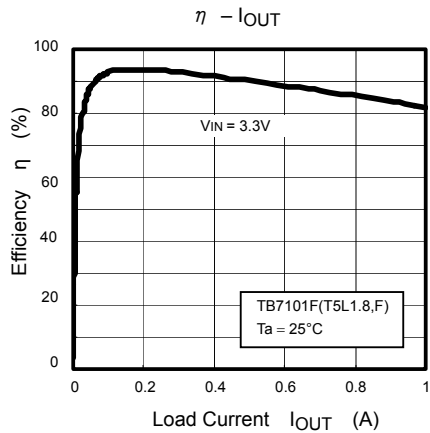
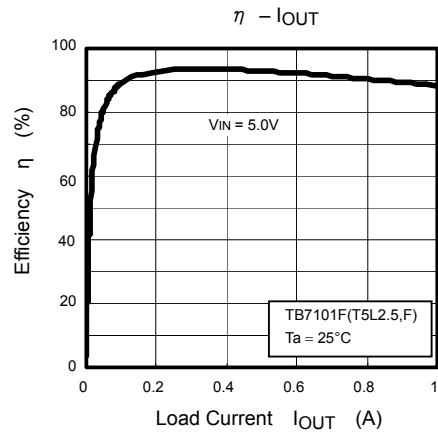
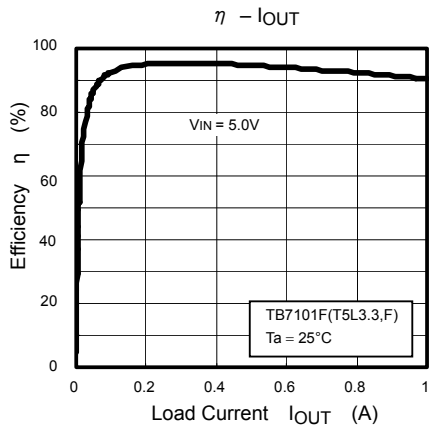
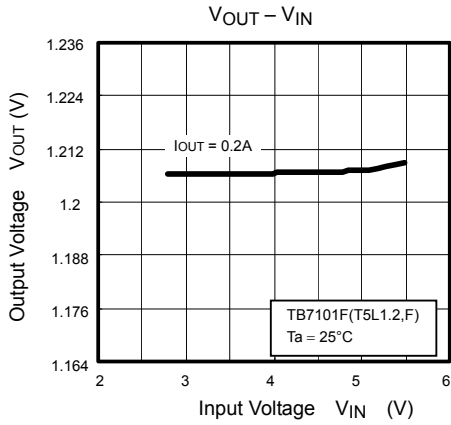

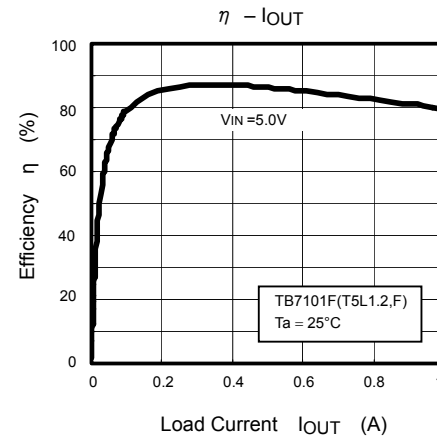
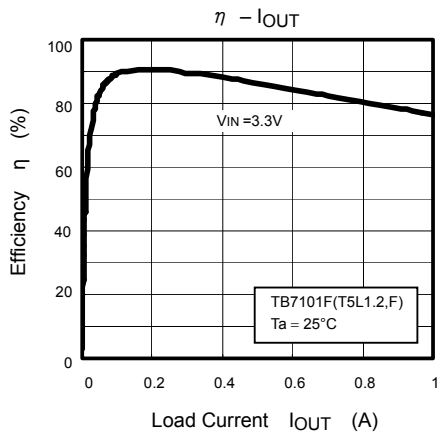
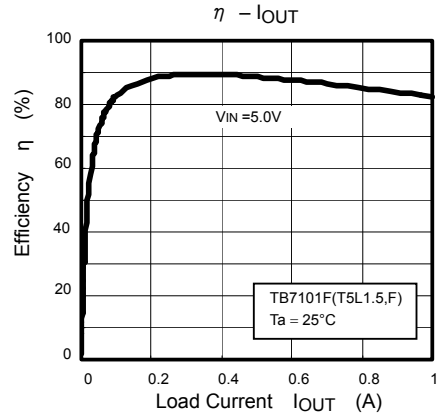
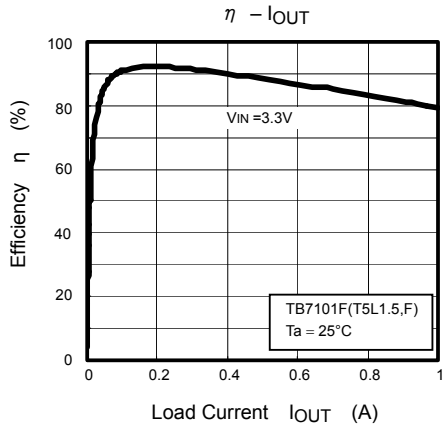

## Package dimensions

SON8-P-0303-0.65A

Unit: mm

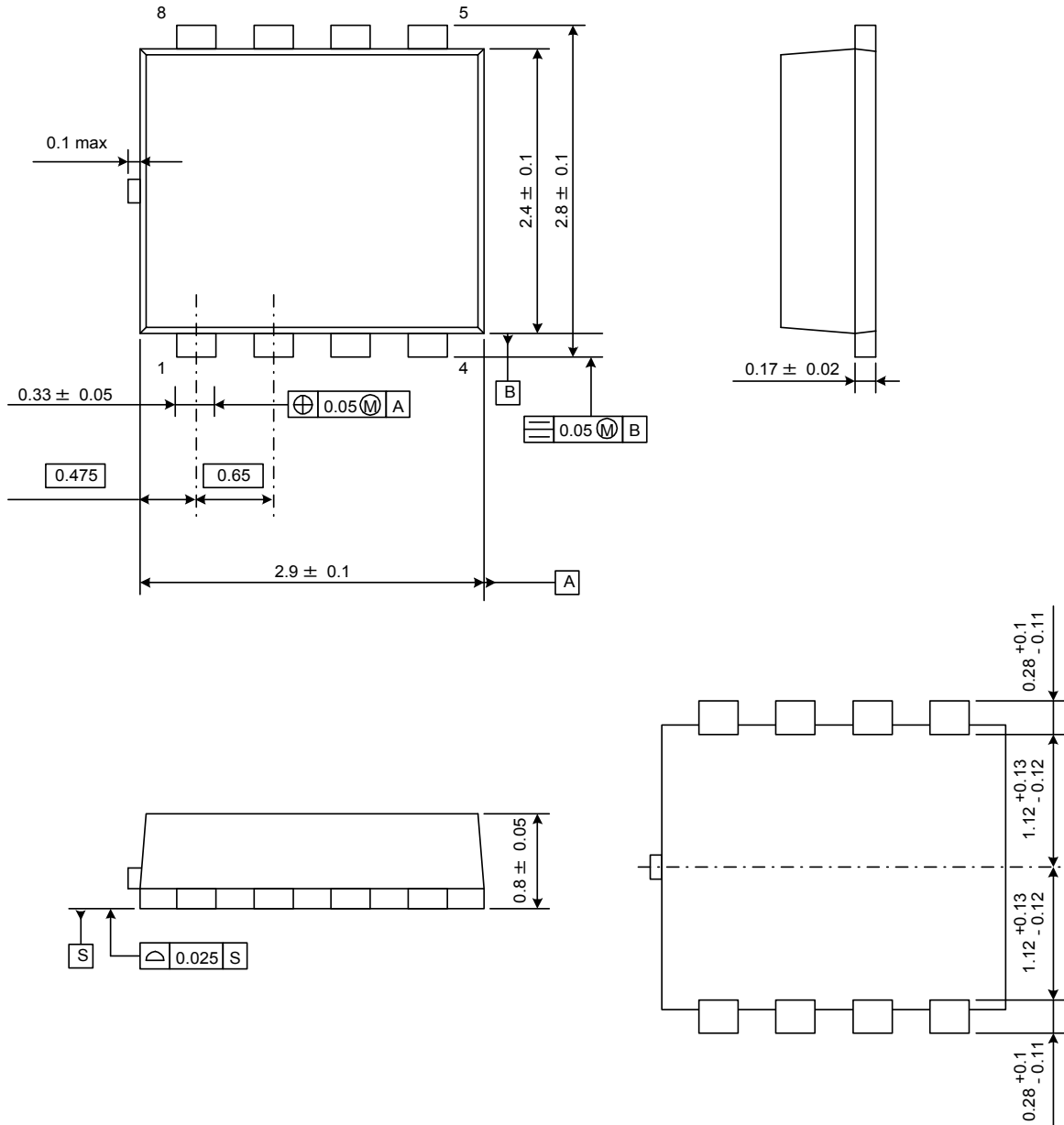

Weight: 0.017 g (Typ.)



**RESTRICTIONS ON PRODUCT USE**

20070701-EN

- The information contained herein is subject to change without notice.
- TOSHIBA is continually working to improve the quality and reliability of its products. Nevertheless, semiconductor devices in general can malfunction or fail due to their inherent electrical sensitivity and vulnerability to physical stress. It is the responsibility of the buyer, when utilizing TOSHIBA products, to comply with the standards of safety in making a safe design for the entire system, and to avoid situations in which a malfunction or failure of such TOSHIBA products could cause loss of human life, bodily injury or damage to property.  
In developing your designs, please ensure that TOSHIBA products are used within specified operating ranges as set forth in the most recent TOSHIBA products specifications. Also, please keep in mind the precautions and conditions set forth in the "Handling Guide for Semiconductor Devices," or "TOSHIBA Semiconductor Reliability Handbook" etc.
- The TOSHIBA products listed in this document are intended for usage in general electronics applications (computer, personal equipment, office equipment, measuring equipment, industrial robotics, domestic appliances, etc.). These TOSHIBA products are neither intended nor warranted for usage in equipment that requires extraordinarily high quality and/or reliability or a malfunction or failure of which may cause loss of human life or bodily injury ("Unintended Usage"). Unintended Usage include atomic energy control instruments, airplane or spaceship instruments, transportation instruments, traffic signal instruments, combustion control instruments, medical instruments, all types of safety devices, etc.. Unintended Usage of TOSHIBA products listed in this document shall be made at the customer's own risk.
- The products described in this document shall not be used or embedded to any downstream products of which manufacture, use and/or sale are prohibited under any applicable laws and regulations.
- Please contact your sales representative for product-by-product details in this document regarding RoHS compatibility. Please use these products in this document in compliance with all applicable laws and regulations that regulate the inclusion or use of controlled substances. Toshiba assumes no liability for damage or losses occurring as a result of noncompliance with applicable laws and regulations.