

# TB7102F

## Buck DC-DC Converter IC

The TB7102F is a single-chip buck DC-DC converter IC. The TB7102F contains high-speed and low-on-resistance power MOSFETs for the main switch and synchronous rectifier to achieve high efficiency.

### Features

- Enables up to 1 A of load current ( $I_{OUT}$ ) with a minimum of external components.
- High efficiency ( $\eta = 95\%$  typ.)  
(@ $V_{IN} = 5\text{ V}$ ,  $V_{OUT} = 3.3\text{ V}$  and  $I_{OUT} = 300\text{ mA}$ )
- Operating voltage ( $V_{IN}$ ) range: 2.7 V to 5.5 V
- A high 1-MHz oscillation frequency (typ.) allows the use of small external components.
- Uses internal phase compensation to achieve high efficiency with a minimum of external components.
- Allows the use of a small surface-mount ceramic capacitor as an output filter capacitor.
- Housed in a small surface-mount package (PS-8) with low thermal resistance.
- Undervoltage lockout (UVLO), thermal shutdown (TSD) and overcurrent protection (OCP)

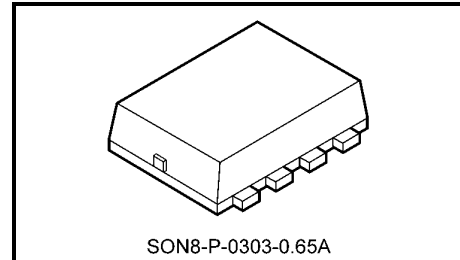

Weight: 0.017 g (typ.)

### Part Marking

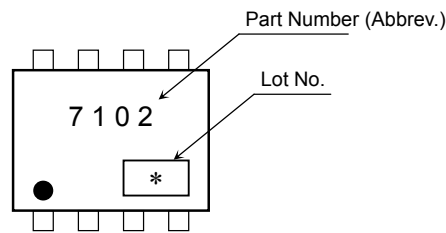

The dot (•) on the top surface indicates pin 1.

### Pin Assignment

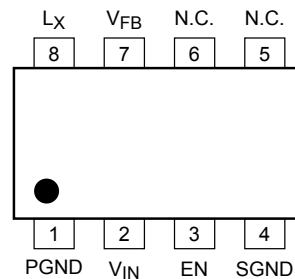

\*: The lot number consists of three digits. The first digit represents the last digit of the year of manufacture, and the following two digits indicates the week of manufacture between 01 and either 52 or 53.

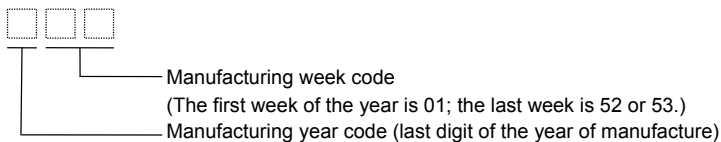

This product has a MOS structure and is sensitive to electrostatic discharge. Handle with care.

The product(s) in this document (“Product”) contain functions intended to protect the Product from temporary small overloads such as minor short-term overcurrent, or overheating. The protective functions do not necessarily protect Product under all circumstances. When incorporating Product into your system, please design the system (1) to avoid such overloads upon the Product, and (2) to shut down or otherwise relieve the Product of such overload conditions immediately upon occurrence. For details, please refer to the notes appearing below in this document and other documents referenced in this document.

## Ordering Information

Part Number	Shipping
TB7102F (TE85L, F)	Embossed tape (3000 units per reel)

## Block Diagram

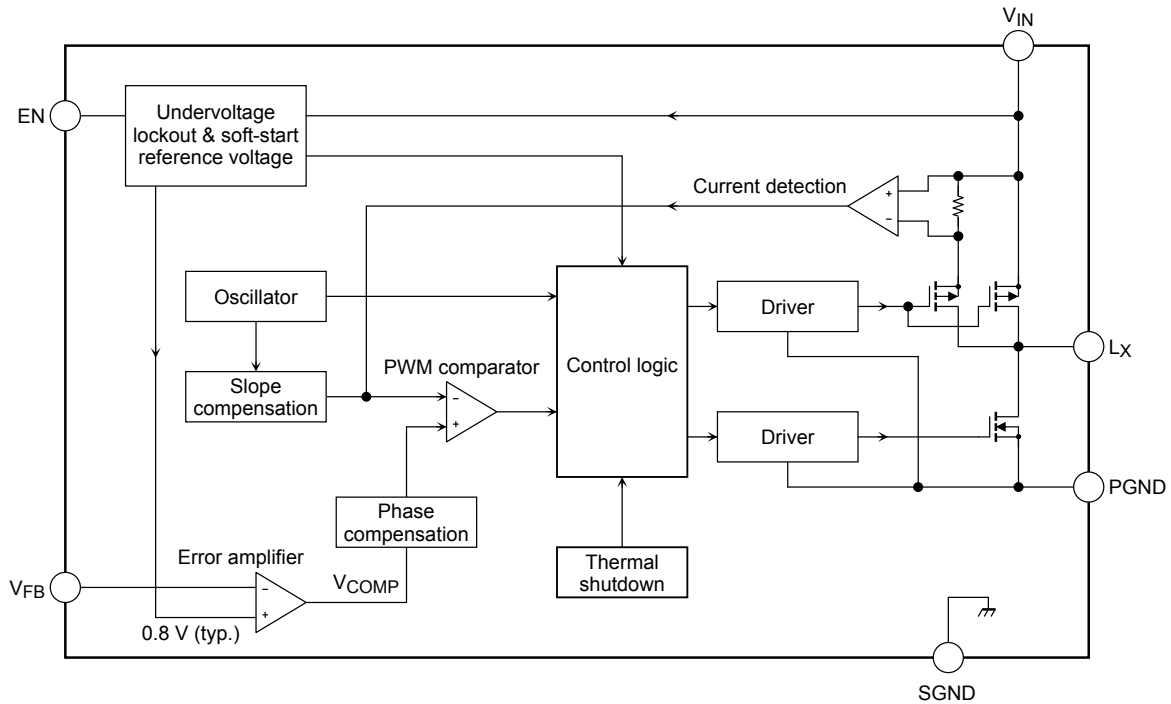

## Pin Description

Pin No.	Symbol	Description
1	PGND	Ground for the output section
2	$V_{IN}$	Input pin This pin is placed in the standby state if $V_{ENB}$ = low. Standby current is 1 $\mu$ A or less.
3	EN	Enable pin This pin is connected to an on-chip CMOS inverter. When $EN \geq 3.5$ V (@ $V_{IN} = 5$ V), the control logic is allowed to operate and thus enable the switching operation of the output section.
4	SGND	Ground for the control logic
5	N.C.	No-connect
6	N.C.	No-connect
7	$V_{FB}$	Feedback pin This input is fed into an internal error amplifier with a reference voltage of 0.8 V (typ.).
8	$L_X$	Switch pin This output is connected to the high-side P-channel MOSFETs and low-side N-channel MOSFET.

**Timing Diagram**  
**Normal Operation**

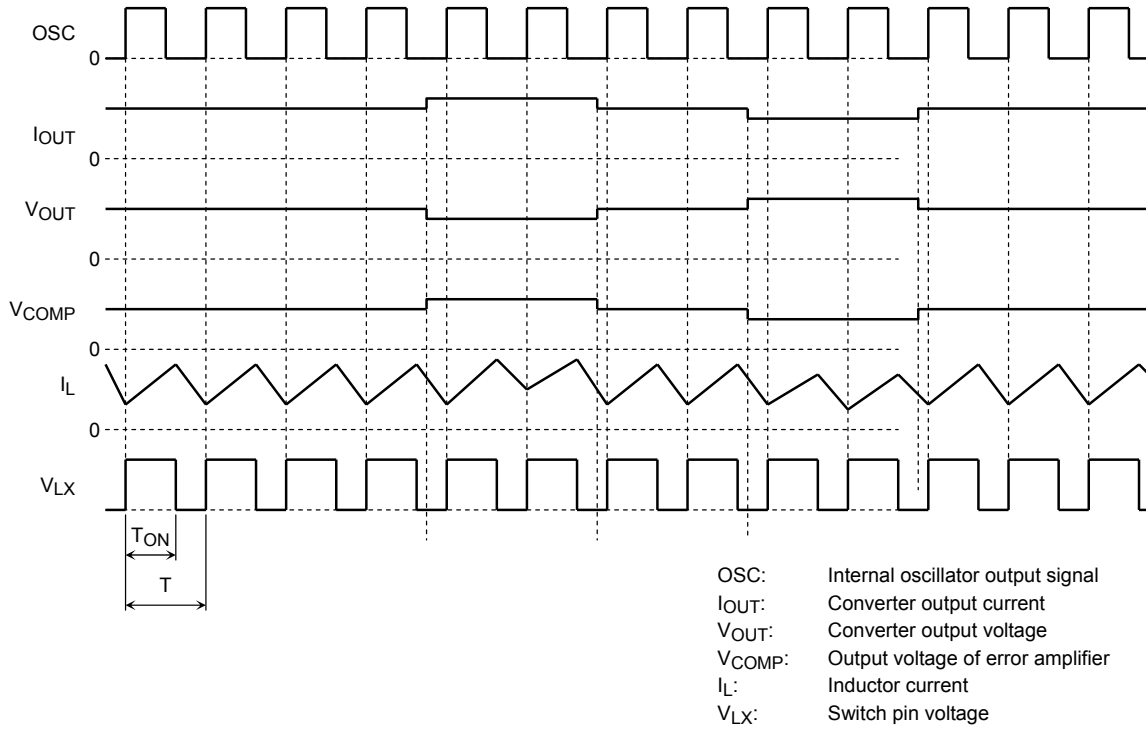

**Absolute Maximum Ratings (Ta = 25°C)**

Characteristics	Symbol	Rating	Unit
Input voltage	V <sub>IN</sub>	-0.3 to 6	V
Enable pin voltage	V <sub>EN</sub>	-0.3 to 6	V
V <sub>EN</sub> -V <sub>IN</sub> voltage difference	V <sub>EN</sub> - V <sub>IN</sub>	V <sub>EN</sub> - V <sub>IN</sub> < 0.3	V
Feedback pin voltage	V <sub>FB</sub>	-0.3 to 6	V
Switch pin voltage	V <sub>LX</sub>	-0.3 to 6	V
Switch pin current	I <sub>LX</sub>	±1.3	A
Power dissipation (Note 1)	P <sub>D</sub>	0.7	W
Operating junction temperature	T <sub>jopr</sub>	-40 to 125	°C
Junction temperature (Note 2)	T <sub>j</sub>	150	°C
Storage temperature	T <sub>stg</sub>	-55 to 150	°C

Note: Using continuously under heavy loads (e.g. the application of high temperature/current/voltage and the significant change in temperature, etc.) may cause this product to decrease in the reliability significantly even if the operating conditions (i.e. operating temperature/current/voltage, etc.) are within the absolute maximum ratings and the operating ranges.

Please design the appropriate reliability upon reviewing the Toshiba Semiconductor Reliability Handbook (“Handling Precautions”/“Derating Concept and Methods”) and individual reliability data (i.e. reliability test report and estimated failure rate, etc)

**Thermal Resistance Characteristics**

Characteristics	Symbol	Max	Unit
Thermal resistance, junction to ambient	R <sub>th(j-a)</sub>	178.6 (Note 1)	°C/W

Note 1:

Glass epoxy board

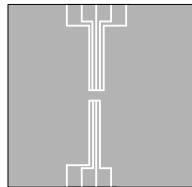

Material: FR-4  
25.4 × 25.4 × 0.8  
(Unit: mm)

Note 2: The TB7102F may go into thermal shutdown at the rated maximum junction temperature. Thermal design is required to ensure that the rated maximum operating junction temperature, T<sub>jopr</sub>, will not be exceeded.

**Electrical Characteristics (unless otherwise specified:  $T_j = 25^\circ\text{C}$  and  $V_{IN} = 2.7$  to  $5.5$  V)**

Characteristics		Symbol	Test Condition	Min	Typ.	Max	Unit
Operating input voltage		$V_{IN(OPR)}$	—	2.7	—	5.5	V
Operating current		$I_{IN1}$	$V_{IN} = 5\text{ V}, V_{EN} = 5\text{ V}, V_{FB} = 5\text{ V}$	—	0.68	0.9	mA
		$I_{IN2}$	$V_{IN} = 2.7\text{ V}, V_{EN} = 2.7\text{ V}, V_{FB} = 2.7\text{ V}$	—	0.55	0.69	mA
Standby current		$I_{IN(STBY)1}$	$V_{IN} = 5\text{ V}, V_{EN} = 0\text{ V}, V_{FB} = 0\text{ V}$	—	—	1	$\mu\text{A}$
		$I_{IN(STBY)2}$	$V_{IN} = 2.7\text{ V}, V_{EN} = 0\text{ V}, V_{FB} = 0\text{ V}$	—	—	1	$\mu\text{A}$
EN threshold voltage		$V_{IH(EN)1}$	$V_{IN} = 5\text{ V}$	3.5	—	—	V
		$V_{IH(EN)2}$	$V_{IN} = 2.7\text{ V}$	1.89	—	—	V
		$V_{IL(EN)1}$	$V_{IN} = 5\text{ V}$	—	—	1.5	V
		$V_{IL(EN)2}$	$V_{IN} = 2.7\text{ V}$	—	—	0.81	V
EN input current		$I_{IH(EN)1}$	$V_{IN} = 5\text{ V}, V_{EN} = 5\text{ V}$	7.6	—	12.4	$\mu\text{A}$
		$I_{IH(EN)2}$	$V_{IN} = 2.7\text{ V}, V_{EN} = 2.7\text{ V}$	4.1	—	6.7	$\mu\text{A}$
VFB input voltage		$V_{FB1}$	$V_{IN} = 5\text{ V}, V_{EN} = 5\text{ V}, I_{OUT} = 10\text{ mA}$	0.776	0.8	0.824	V
		$V_{FB2}$	$V_{IN} = 2.7\text{ V}, V_{EN} = 2.7\text{ V}, I_{OUT} = 10\text{ mA}$	0.776	0.8	0.824	V
VFB input current		$I_{FB1}$	$V_{IN} = 5\text{ V}, V_{EN} = 5\text{ V}$	-1	—	1	$\mu\text{A}$
		$I_{FB2}$	$V_{IN} = 2.7\text{ V}, V_{EN} = 2.7\text{ V}$	-1	—	1	$\mu\text{A}$
High-side switch on-state resistance		$R_{DS(ON)(H)1}$	$V_{IN} = 5\text{ V}, V_{EN} = 5\text{ V}, I_{LX} = -0.5\text{ A}$	—	0.27	—	$\Omega$
		$R_{DS(ON)(H)2}$	$V_{IN} = 2.7\text{ V}, V_{EN} = 2.7\text{ V}, I_{LX} = -0.5\text{ A}$	—	0.36	—	$\Omega$
Low-side switch on-state resistance		$R_{DS(ON)(L)1}$	$V_{IN} = 5\text{ V}, V_{EN} = 5\text{ V}, I_{LX} = 0.5\text{ A}$	—	0.27	—	$\Omega$
		$R_{DS(ON)(L)2}$	$V_{IN} = 2.7\text{ V}, V_{EN} = 2.7\text{ V}, I_{LX} = 0.5\text{ A}$	—	0.36	—	$\Omega$
High-side switch leakage current		$I_{LEAK(H)}$	$V_{IN} = 5\text{ V}, V_{EN} = 0\text{ V}, V_{LX} = 0\text{ V}$	—	—	-1	$\mu\text{A}$
Low-side switch leakage current		$I_{LEAK(L)}$	$V_{IN} = 5\text{ V}, V_{EN} = 0\text{ V}, V_{LX} = 5\text{ V}$	—	—	1	$\mu\text{A}$
Oscillation frequency		$f_{osc1}$	$V_{IN} = 5\text{ V}, V_{EN} = 5\text{ V}$	0.85	1	1.15	MHz
		$f_{osc2}$	$V_{IN} = 2.7\text{ V}, V_{EN} = 2.7\text{ V}$	0.85	1	1.15	MHz
Soft-start time		$t_{ss1}$	$V_{IN} = 5\text{ V}, V_{EN} = 5\text{ V}, I_{OUT} = 0\text{ A}$	1	2	—	ms
		$t_{ss2}$	$V_{IN} = 2.7\text{ V}, V_{EN} = 2.7\text{ V}, I_{OUT} = 0\text{ A}$	1.3	2.4	—	ms
Thermal shutdown (TSD)	Detection temperature	$T_{SD}$	$V_{IN} = 5\text{ V}$	—	160	—	$^\circ\text{C}$
	Hysteresis	$\Delta T_{SD}$	$V_{IN} = 5\text{ V}$	—	20	—	$^\circ\text{C}$
Undervoltage lockout (UVLO)	Detection voltage	$V_{UV}$	$V_{IN} = V_{EN}$	2.2	2.4	2.6	V
	Recovery voltage	$V_{UVR}$	$V_{IN} = V_{EN}$	2.3	2.5	2.7	V
	Hysteresis	$\Delta V_{UV}$	$V_{IN} = V_{EN}$	—	0.1	—	V
LX current limit		$I_{LIM}$	$V_{IN} = 5\text{ V}$	1.3	2.8	—	A

**Note on Electrical Characteristics**

The test condition  $T_j = 25^\circ\text{C}$  means a state where any drifts in electrical characteristics incurred by an increase in the chip's junction temperature can be ignored during pulse testing.

**Application Circuit Example**

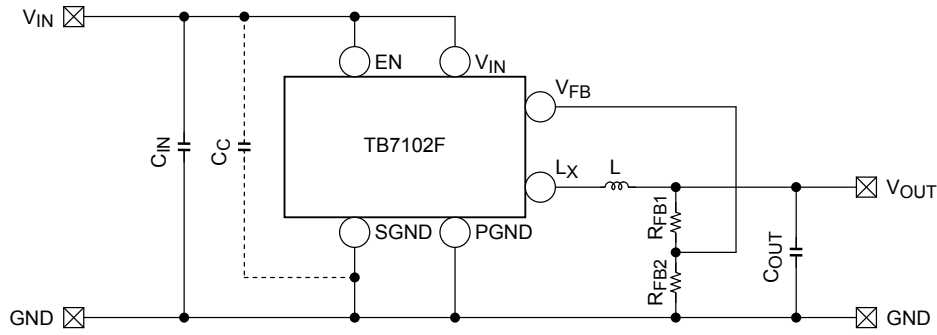

**Figure 1 TB7102F Application Circuit Example**

Component values (@VIN = 5 V, VOUT = 3.3 V, Ta = 25°C)

These values are presented only as a guide.

- CIN: Input filter capacitor = 10 μF  
(ceramic capacitor: GRM21BB30J106K from Murata Manufacturing Co., Ltd.)
- COUT: Output filter capacitor = 10 μF  
(ceramic capacitor: GRM21BB30J106K from Murata Manufacturing Co., Ltd.)
- RFB1: Output voltage setting resistor = 7.5 kΩ
- RFB2: Output voltage setting resistor = 2.4 kΩ
- L: Inductor = 3.3 μH (NP04SB3R3N from Taiyo Yuden Co., Ltd.)

Component values (@VIN = 5 V, VOUT = 1.2 V, Ta = 25°C)

These values are presented only as a guide.

- CIN: Input filter capacitor = 10 μF  
(ceramic capacitor: GRM21BB30J106K from Murata Manufacturing Co., Ltd.)
- COUT: Output filter capacitor = 22 μF  
(ceramic capacitor: GRM31CB30J226K from Murata Manufacturing Co., Ltd.)
- RFB1: Output voltage setting resistance = 1.2 kΩ
- RFB2: Output voltage setting resistance = 2.4 kΩ
- L: Inductor = 3.3 μH (NP04SB3R3N from Taiyo Yuden Co., Ltd.)

Component values need to be adjusted, depending on the TB7102F's input/output conditions and the board layout.

**Application Notes**

**Inductor Selection**

The inductance required for inductor L can be calculated as follows:

$$L = \frac{V_{IN} - V_{OUT}}{f_{osc} \cdot \Delta I_L} \cdot \frac{V_{OUT}}{V_{IN}} \dots\dots\dots(1)$$

VIN:	Input voltage (V)
VOUT:	Output voltage (V)
fosc:	Oscillation frequency = 1 MHz (typ.)
ΔIL:	Inductor ripple current (A)

\*: Generally, ΔIL should be set to approximately 30% of the maximum output current. Since the maximum output current of the TB7102F is 1 A, ΔIL should be 0.3 A or so. Therefore, the inductor should have a current rating greater than the peak output current of 1.15 A. If the inductor current rating is exceeded, the inductor becomes saturated, leading to an unstable DC-DC converter operation.

When VIN = 5 V and VOUT = 3.3 V, the required inductance can be calculated as follows. Be sure to select an appropriate inductor, taking the VIN range into account.

$$L = \frac{V_{IN} - V_{OUT}}{f_{osc} \cdot \Delta I_L} \cdot \frac{V_{OUT}}{V_{IN}}$$

$$= \frac{5\text{ V} - 3.3\text{ V}}{1\text{ MHz} \cdot 300\text{ mA}} \cdot \frac{3.3\text{ V}}{5\text{ V}} \dots\dots(2)$$

$$= 3.7\text{ }\mu\text{H}$$

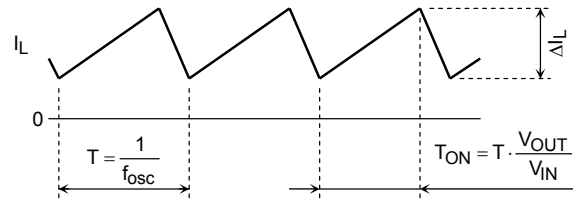

Figure 2 Inductor Current Waveform

**Setting the Output Voltage**

A resistive voltage divider is connected as shown in Figure 3 to set the output voltage; it is given by Equation 3 based on the reference voltage of the error amplifier, which is connected to the Feedback pin, VFB. RFB1 should be up to 10 kΩ or so, because an extremely large value RFB1 incurs a delay due to parasitic capacitance at the VFB pin. If the difference between the input and output voltages is small, the output voltage may drop, depending on the load current conditions. For optimal operation, output voltage should be set to 0.8 V (typ.) at the minimum and to (V<sub>IN</sub> - 1) V at the maximum. It is recommended that resistors with a precision of ±1% or higher be used for RFB1 and RFB2.

$$V_{OUT} = V_{FB} \cdot \left(1 + \frac{R_{FB1}}{R_{FB2}}\right)$$

$$= 0.8\text{ V} \times \left(1 + \frac{R_{FB1}}{R_{FB2}}\right) \dots\dots(3)$$

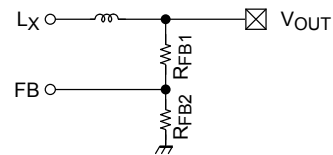

Figure 3 Output Voltage Setting Resistors

**Output Capacitor Selection**

Use a ceramic capacitor as the output filter capacitor. Since a ceramic capacitor is generally sensitive to temperature, choose one with excellent temperature characteristics (such as the JIS B characteristic). As a rule of thumb, its capacitance should be 10 μF or greater for applications where V<sub>OUT</sub> ≥ 2.0 V, and 20 μF or greater for applications where V<sub>OUT</sub> < 2.0 V. The capacitance should be set to an optimal value that meets the system's ripple voltage requirement and transient load response characteristics. Since the ceramic capacitor has a very low ESR value, it helps reduce the output ripple voltage; however, because the ceramic capacitor provides less phase margin, it should be thoroughly evaluated.

**Component Values (@V<sub>IN</sub> = 5 V, T<sub>a</sub> = 25°C)**

These values are presented only as a guide.

The following values may need tuning depending on the TB7102F's input/output conditions and the board layout.

Output Voltage Setting V <sub>OUT</sub>	Inductance L	Input Capacitance C <sub>IN</sub>	Output Capacitance C <sub>OUT</sub>	Feedback Resistor R <sub>FB1</sub>	Feedback Resistor R <sub>FB2</sub>
1.2 V	3.3 μH	10 μF	22 μF	1.2 kΩ	2.4 kΩ
1.5 V	3.3 μH	10 μF	22 μF	2.1 kΩ	2.4 kΩ
1.8 V	3.3 μH	10 μF	22 μF	3.0 kΩ	2.4 kΩ
2.5 V	3.3 μH	10 μF	10 μF	5.1 kΩ	2.4 kΩ
3.3 V	3.3 μH	10 μF	10 μF	7.5 kΩ	2.4 kΩ

**Undervoltage Lockout (UVLO)**

The TB7102F has undervoltage lockout (UVLO) protection circuitry. The TB7102F does not provide output voltage (VOUT) until the input voltage has reached VUVR (2.5 V typ.). UVLO has hysteresis of 0.1 V (typ.). After the switch turns on, if VIN drops below VUV (2.4 V typ.), UVLO shuts off the switch at VOUT.

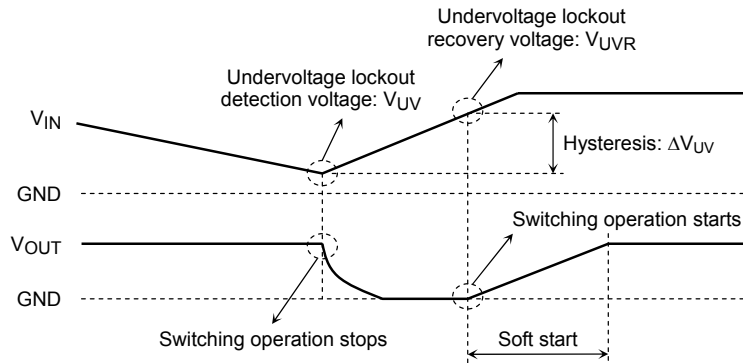
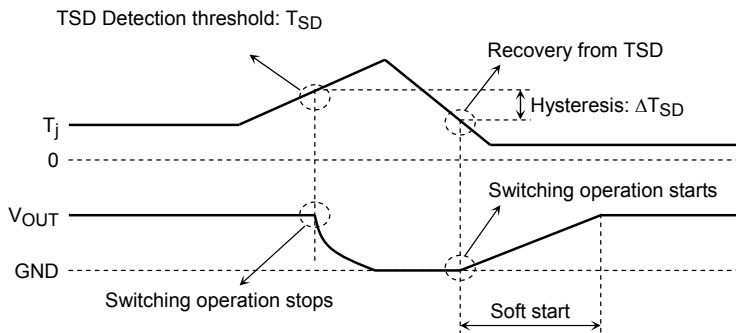

**Figure 4 Undervoltage Lockout Operation**

**Thermal Shutdown (TSD)**

The TB7102F provides thermal shutdown. When the junction temperature continues to rise and reaches TSD (160°C typ.), the TB7102F goes into thermal shutdown and shuts off the power supply. TSD has a hysteresis of about 20°C. The device is enabled again when the junction temperature has dropped by approximately 20°C from the TSD trip point. The device resumes the power supply when the soft-start circuit is used upon recovery from the TSD state .

Thermal shutdown is intended to protect the device against abnormal system conditions. It should be ensured that the TSD circuit will not be activated during normal operation of the system.



**Figure 5 Thermal Shutdown Operation**



**Usage Precautions**

- The input voltage, output voltage, output current and temperature conditions should be considered when selecting capacitors, inductors and resistors. These components should be evaluated on an actual system prototype for best selection.
- External components such as capacitors, inductor and resistors should be placed as close to the TB7102F as possible.
- The TB7102F has an ESD diode between the EN and  $V_{IN}$  pins. The voltage between these pins should satisfy  $V_{EN} - V_{IN} < 0.3$  V.
- Operation might become unstable due to board layout. In that case, add a decoupling capacitor ( $C_C$ ) of 0.1  $\mu$ F to 1 $\mu$ F between the SGND and  $V_{IN}$  pins.
- The overcurrent protection circuits in the Product are designed to temporarily protect Product from minor overcurrent of brief duration. When the overcurrent protective function in the Product activates, immediately cease application of overcurrent to Product. Improper usage of Product, such as application of current to Product exceeding the absolute maximum ratings, could cause the overcurrent protection circuit not to operate properly and/or damage Product permanently even before the protection circuit starts to operate.
- The thermal shutdown circuits in the Product are designed to temporarily protect Product from minor overheating of brief duration. When the overheating protective function in the Product activates, immediately correct the overheating situation. Improper usage of Product, such as the application of heat to Product exceeding the absolute maximum ratings, could cause the overheating protection circuit not to operate properly and/or damage Product permanently even before the protection circuit starts to operate.

Typical Performance Characteristics

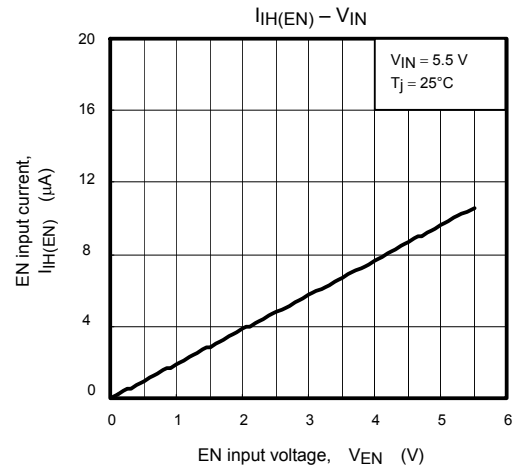
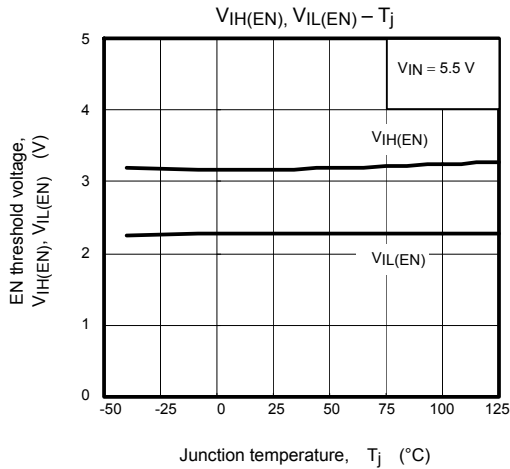
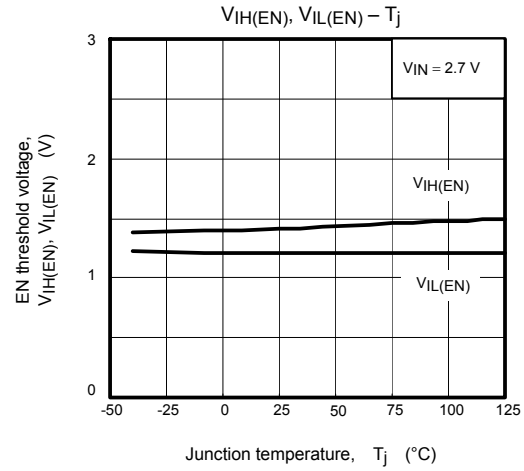
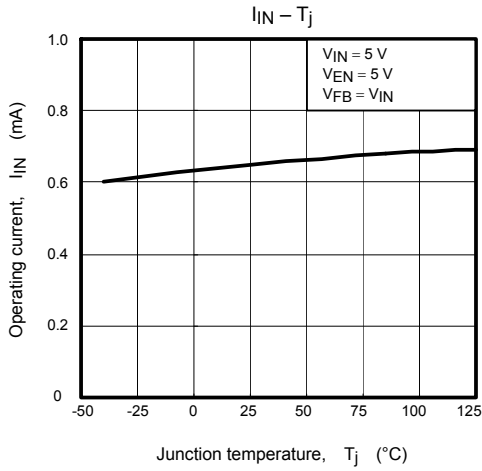
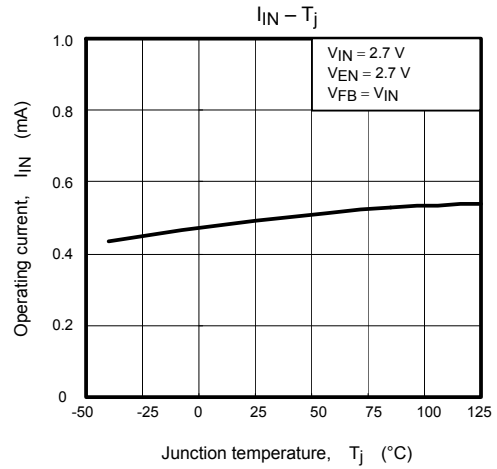
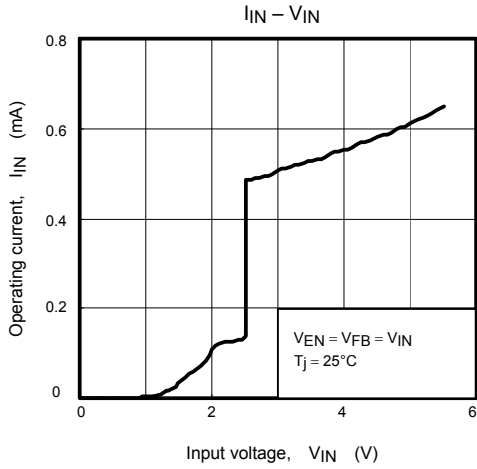

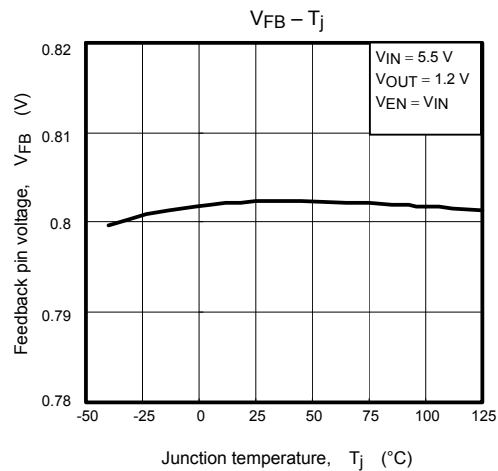
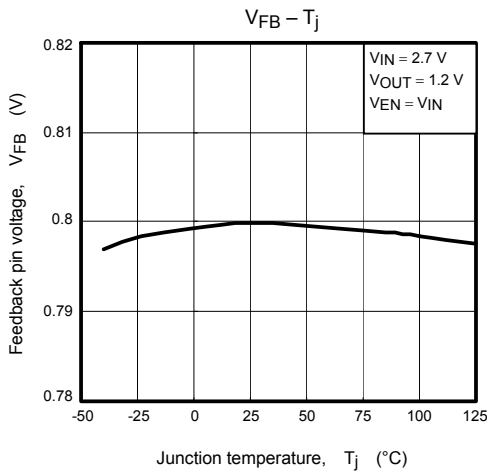
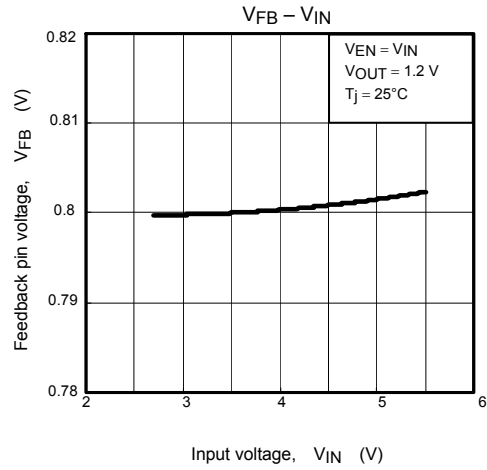
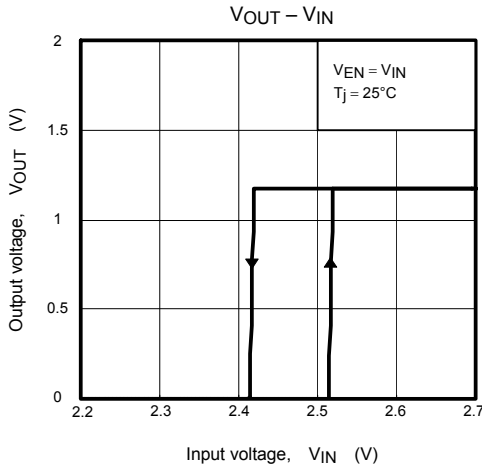
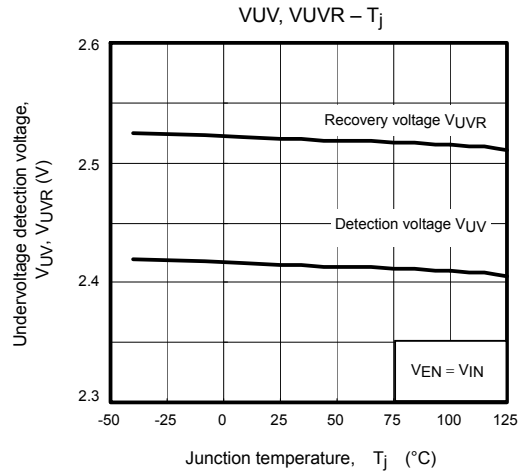
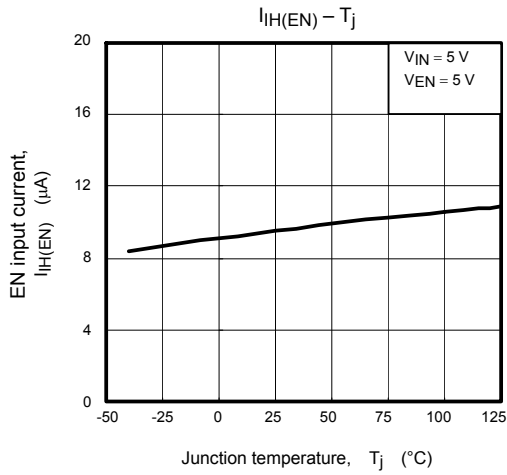

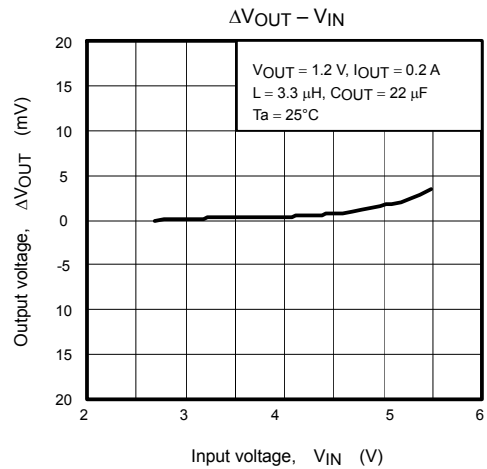
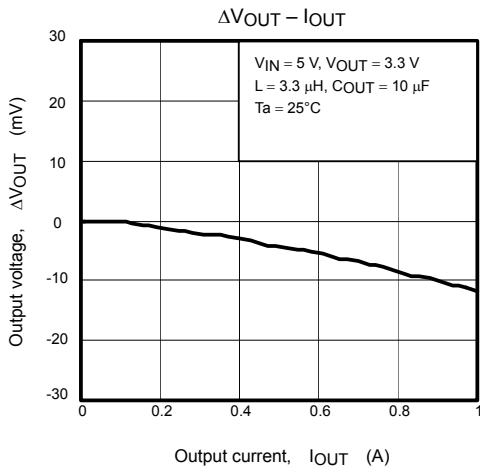
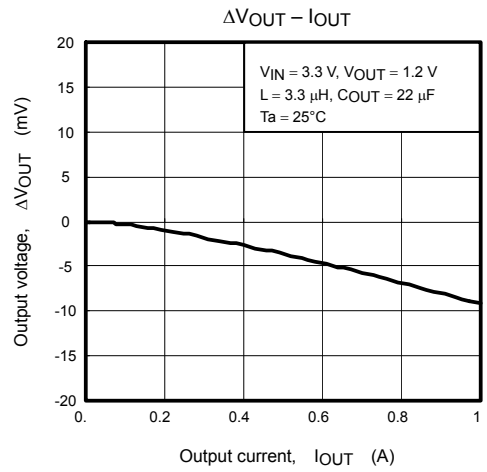
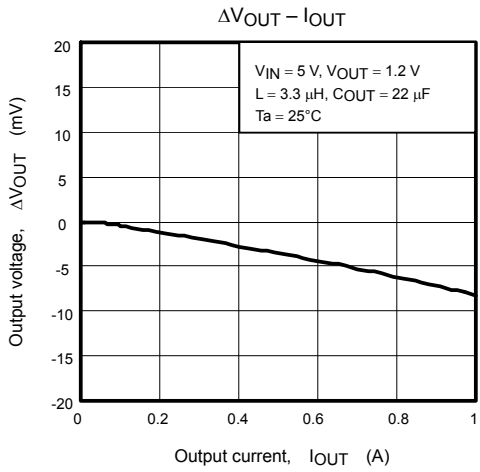
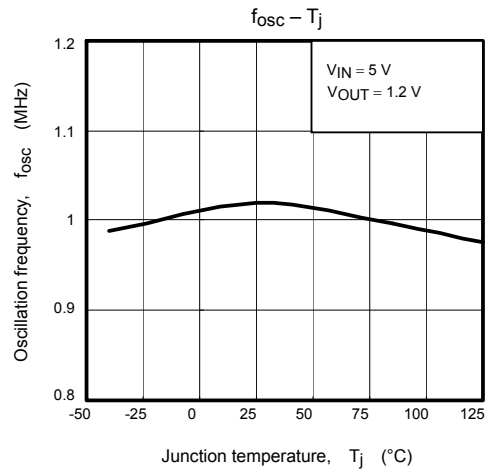
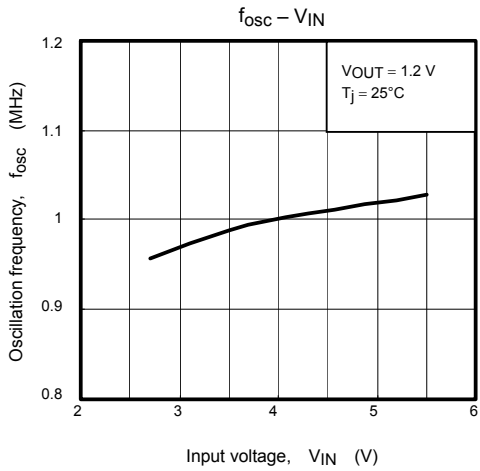

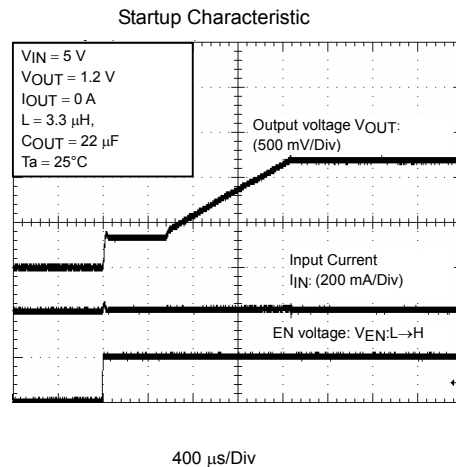
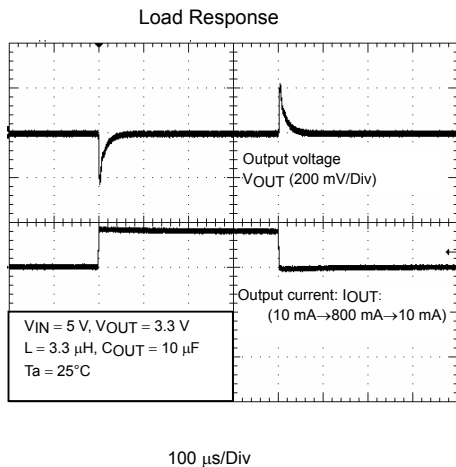
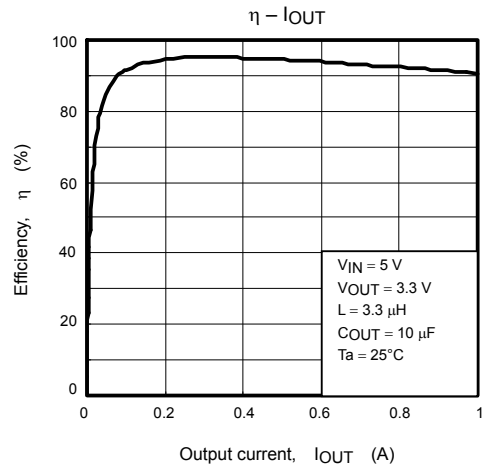
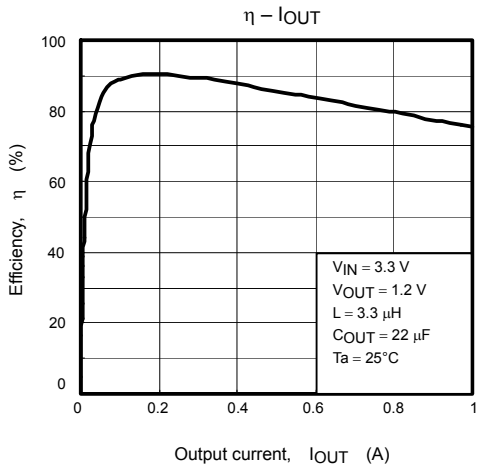
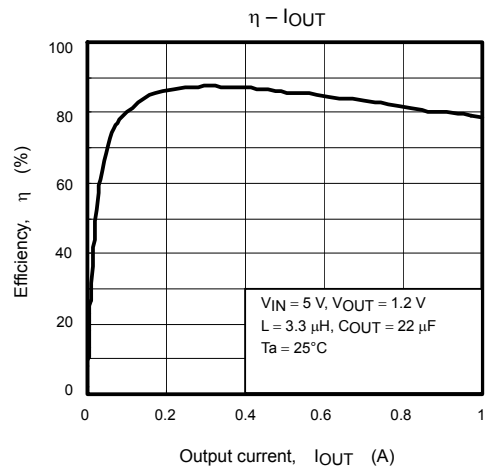
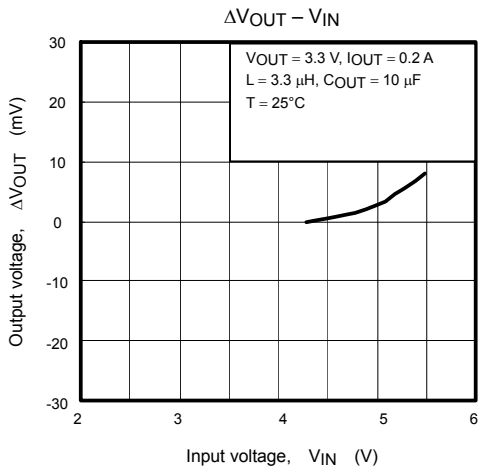

## Board Layout Example

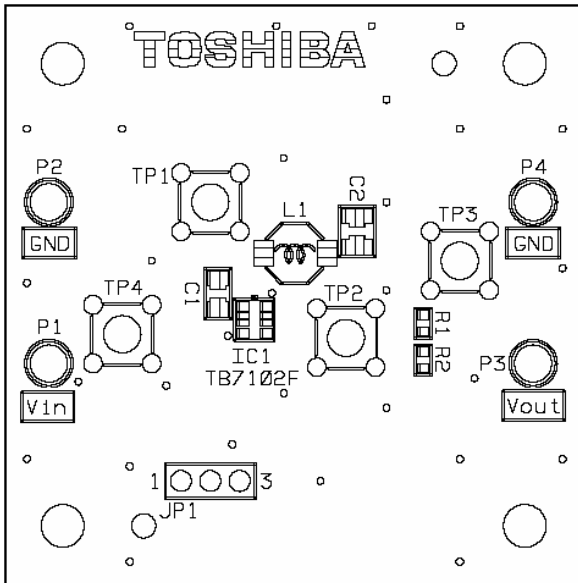

Component side silk

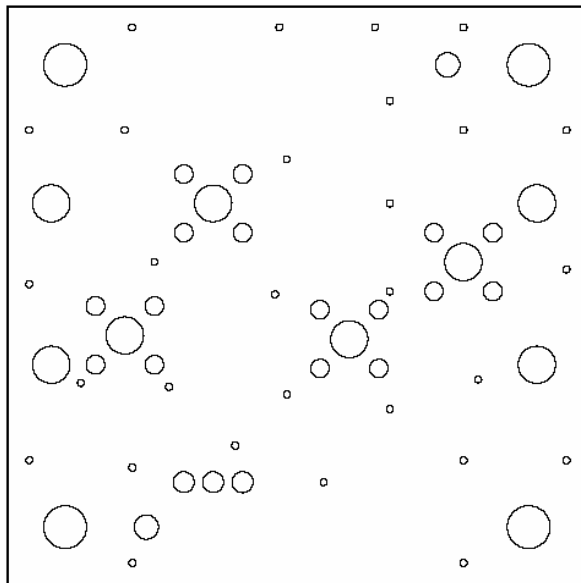

Solder side silk

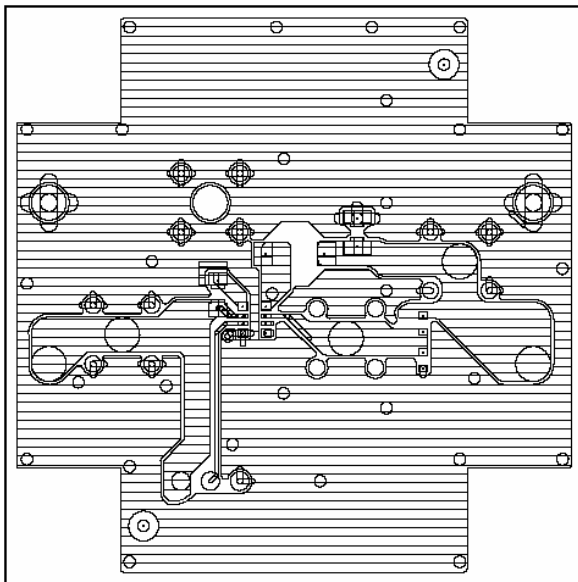

Component side pattern

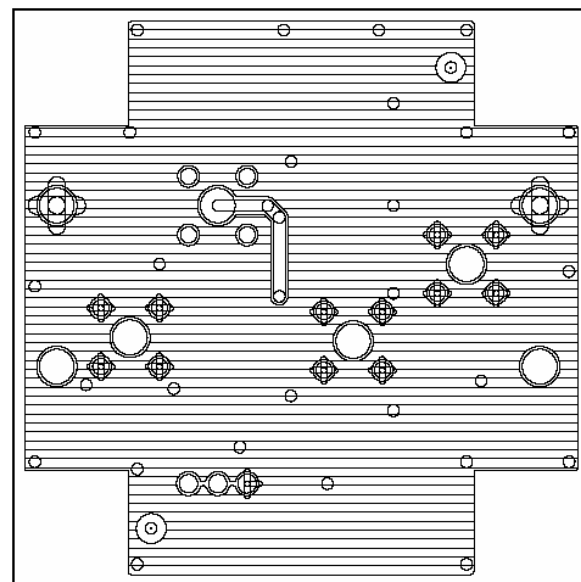

Solder side pattern

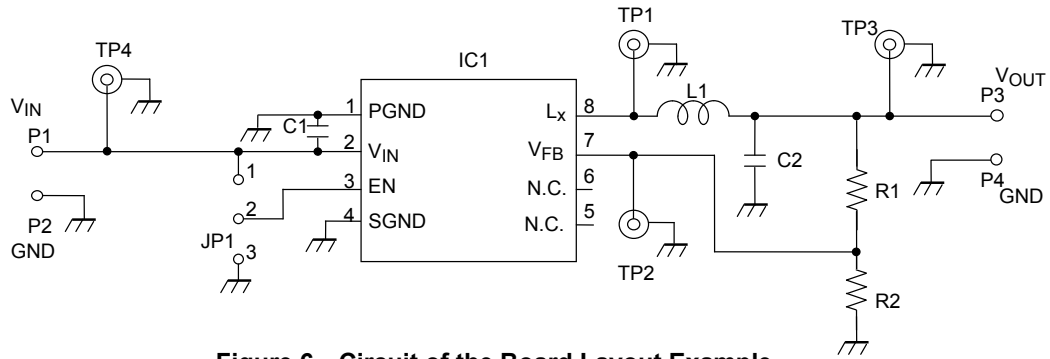

**Figure 6 Circuit of the Board Layout Example**

### External Component Examples

Label	Vendor	Part Number
IC1	Toshiba Corporation	TB7102F
C1	Murata Manufacturing Co., Ltd.	GRM21BB30J106K
C2	Murata Manufacturing Co., Ltd.	GRM21BB30J106K
R1	KOA Corporation	RK73H1ET
R2	KOA Corporation	RK73H1ET
L1	Taiyo Yuden Co., Ltd.	NP04SB3R3N

## Package Dimensions

SON8-P-0303-0.65A

Unit: mm

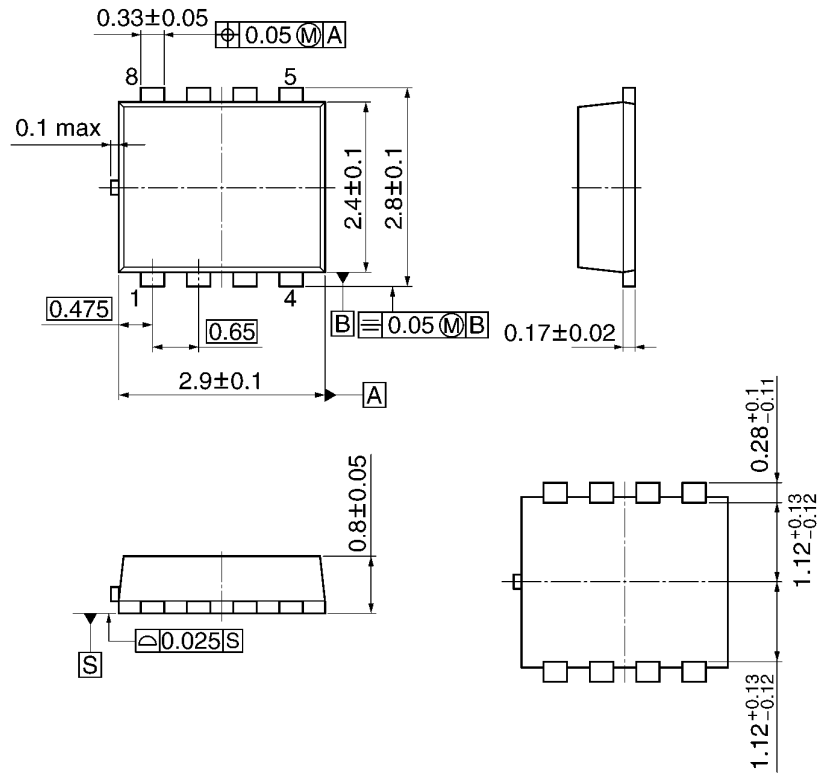

Weight: 0.017 g (typ.)



**RESTRICTIONS ON PRODUCT USE**

20070701-EN GENERAL

- The information contained herein is subject to change without notice.
- TOSHIBA is continually working to improve the quality and reliability of its products. Nevertheless, semiconductor devices in general can malfunction or fail due to their inherent electrical sensitivity and vulnerability to physical stress. It is the responsibility of the buyer, when utilizing TOSHIBA products, to comply with the standards of safety in making a safe design for the entire system, and to avoid situations in which a malfunction or failure of such TOSHIBA products could cause loss of human life, bodily injury or damage to property.  
In developing your designs, please ensure that TOSHIBA products are used within specified operating ranges as set forth in the most recent TOSHIBA products specifications. Also, please keep in mind the precautions and conditions set forth in the "Handling Guide for Semiconductor Devices," or "TOSHIBA Semiconductor Reliability Handbook" etc.
- The TOSHIBA products listed in this document are intended for usage in general electronics applications (computer, personal equipment, office equipment, measuring equipment, industrial robotics, domestic appliances, etc.). These TOSHIBA products are neither intended nor warranted for usage in equipment that requires extraordinarily high quality and/or reliability or a malfunction or failure of which may cause loss of human life or bodily injury ("Unintended Usage"). Unintended Usage include atomic energy control instruments, airplane or spaceship instruments, transportation instruments, traffic signal instruments, combustion control instruments, medical instruments, all types of safety devices, etc.. Unintended Usage of TOSHIBA products listed in this document shall be made at the customer's own risk.
- The products described in this document shall not be used or embedded to any downstream products of which manufacture, use and/or sale are prohibited under any applicable laws and regulations.
- Please contact your sales representative for product-by-product details in this document regarding RoHS compatibility. Please use these products in this document in compliance with all applicable laws and regulations that regulate the inclusion or use of controlled substances. Toshiba assumes no liability for damage or losses occurring as a result of noncompliance with applicable laws and regulations.