

PQ1CX22H2ZPQ

Low Output Bootstrap system
Chopper Regulator

■ Features

- 1.Low output voltage :MIN.1.2V
- 2.Maximum switching current: 2.5A
- 3.High efficiency(efficiency : 88%[$V_{IN}=5V, V_{OUT}=3.3V$])
- 4.Built-in oscillation circuit
(Oscillation frequency:TYP.150kHz)
- 5.Built-in overheat, overcurrent protection functions
- 6.RoHS directive compliant

■ Applications

- 1.AV equipment
- 2.Digital OA equipment

■ Absolute Maximum Ratings

($T_a=25^{\circ}C$)

Parameter	Symbol	Rating	Unit
*1 Input voltage	V_{IN}	33	V
*2 Boost terminal voltage	V_B	33	V
*3 Voltage between V_B and V_{IN}	V_{B-I}	15	V
Malfunction input voltage	V_{ADJ}	7	V
Input-output voltage	V_{I-O}	34	V
*4 Output-GND voltage	V_{OUT}	-1	V
*5 ON/OFF control voltage	V_C	-0.3 to 20	V
Switching current	I_{SW}	2.5	A
*6 Power dissipation	P_d	0.9	W
*7 Junction temperature	T_j	150	$^{\circ}C$
Operating temperature	T_{opr}	-40 to +85	$^{\circ}C$
Storage temperature	T_{stg}	-40 to +150	$^{\circ}C$
Soldering temperature	T_{sol}	260(for 10s)	$^{\circ}C$

*1 Voltage between V_{IN} and GND

*2 Voltage between V_B and GND

*3 Voltage between V_B and V_{IN}

*4 Voltage between V_{OUT} and GND

*5 Voltage between ON/OFF and GND

*6 At the time of the PCB mounting

*7 There is case that over heat protection function operates at the temperature $T_j=125^{\circ}C$ to $150^{\circ}C$, so this item cannot be used in this temperature range.

■ Outline Dimensions

(Unit:mm)

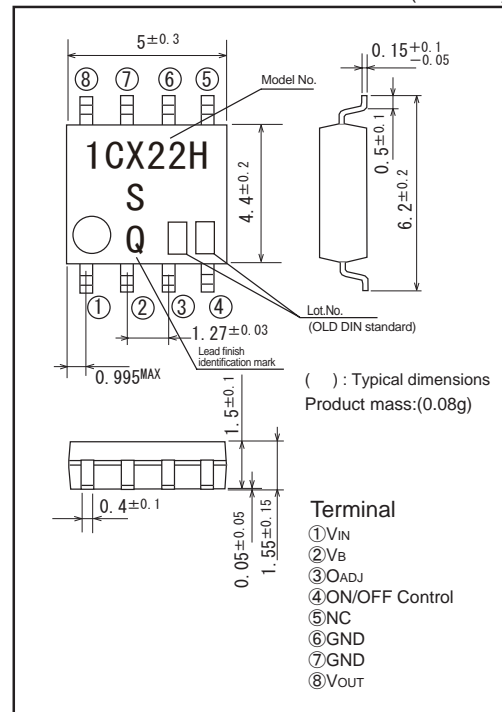

Lead finish:Lead-free solder plating
(Composition: Sn2Bi)

Notice The content of data sheet is subject to change without prior notice.

In the absence of confirmation by device specification sheets, SHARP takes no responsibility for any defects that may occur in equipment using any SHARP devices shown in catalogs, data books, etc. Contact SHARP in order to obtain the latest device specification sheets before using any SHARP device.

Electrical Characteristics

(Unless otherwise specified, condition shall be $V_{IN}=5V, I_o=0.5A, V_o=3.3V$, ON/OFF terminal : Open, $T_a=25^\circ C$)

Parameter	Symbol	Conditions	MIN.	TYP.	MAX.	Unit
Input-output voltage ratio	DI-O1	$V_{IN} > 14V$	15	-	-	%
	DI-O2	$V_{IN} \leq 14V$	8.5	-	-	%
Output saturation voltage	V_{SAT}	$I_{sw}=2.0A$	-	0.25	0.4	V
Reference voltage	V_{REF}	-	0.975	1.0	1.025	V
Load regulation	RegL	$I_o=0.5$ to 2.0A	-	0.2	1.5	%
Line regulation	Regl	$V_{IN}=5$ to 20V	-	1	2.5	%
Efficiency	η	$I_o=2.0 A$	-	88	-	%
Oscillation frequency	f_o	-	135	150	165	kHz
Overcurrent detection level	I_L	Switching current peak	2.55	3.2	4.2	A
Maximum duty	D_{MAX}	3pin = 0.9V	83	90	-	%
Charge current	I_{CHG}	3,8 pin :Open, 4 pin	-	-10	-	μA
Input threshold voltage	V_{THL}	Duty=0 %, 3pin=0V, 4pin	-	1.3	-	V
	V_{THH}	Duty= D_{MAX} , 3pin :Open, 4pin	-	2.3	-	V
ON threshold voltage	V_{THON}	3pin=0V, 4pin	0.7	0.8	0.9	V
Standby-current	I_{SD}	$V_{IN}=33V, 4pin=0V$	-	120	400	μA
Output OFF-state consumption current	I_{QS}	$V_{IN}=33V, 4pin=0.9V$	-	6	10	mA
Minimum Input Voltage	$V_{IN(MIN)}$	-	-	-	4.5	V
Minimum Boost Voltage	$V_{BOOST(MIN)}$	Voltage between V_b terminal and V_{OUT} terminal	-	-	3	V

Fig.1 Test Circuit

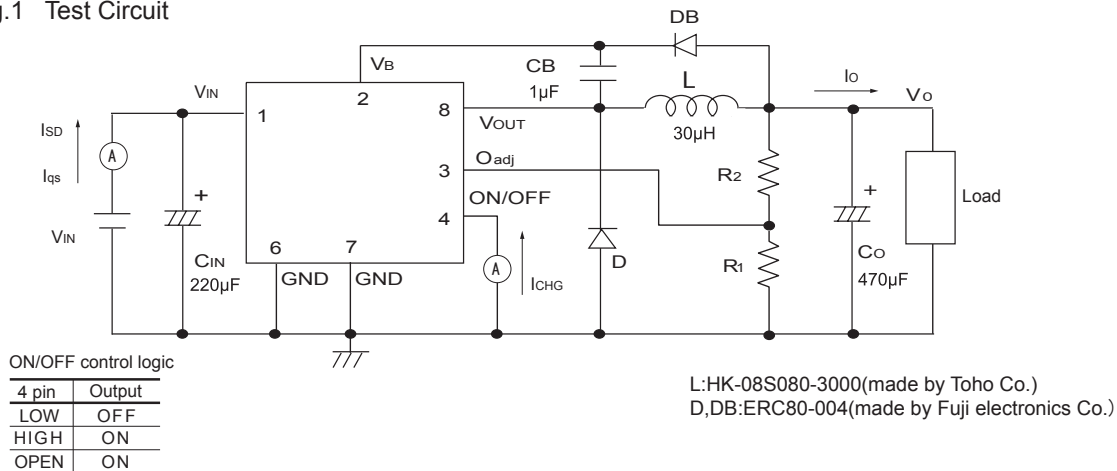
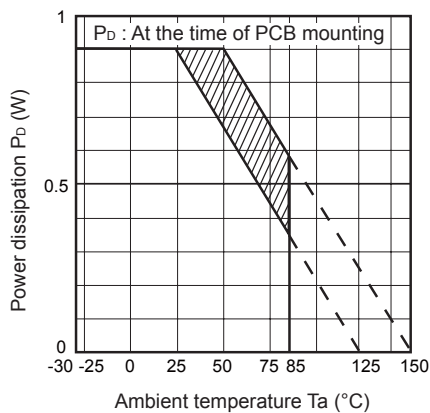

Fig.2 Power Dissipation vs.Ambient Temperature



Note)Oblique line portion:Overheat protection may operate in this area

Fig.3 Overcurrent Protection Characteristics (Typical Value)

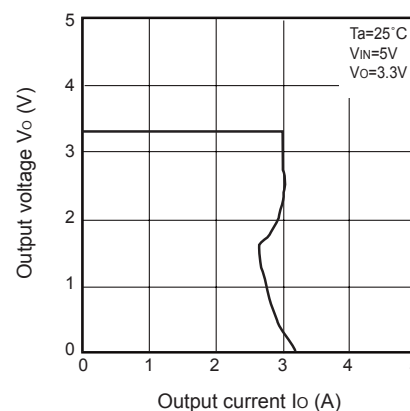

Fig.4 Efficiency vs. Input Voltage

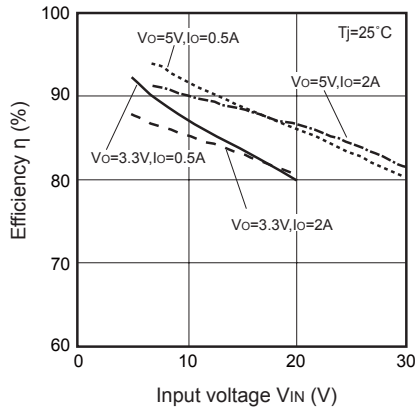

Fig.5 Output Saturation Voltage vs. Switching Current

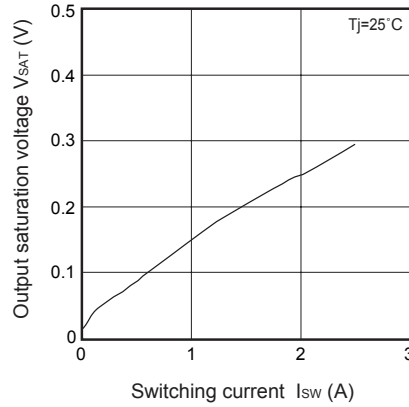

Fig.6 Reference Voltage Fluctuation vs. Junction Temperature

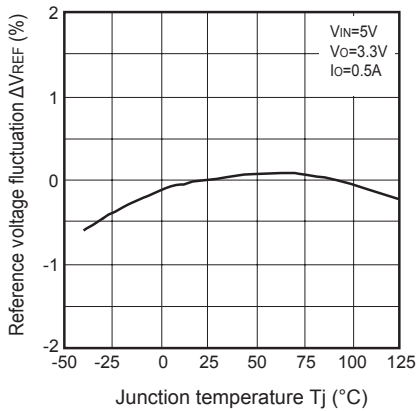

Fig.7 Oscillation Frequency Fluctuation vs. Junction Temperature

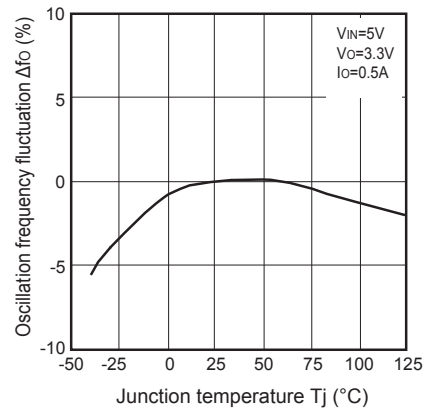

Fig.8 Overcurrent Detecting Level Fluctuation vs. Junction Temperature

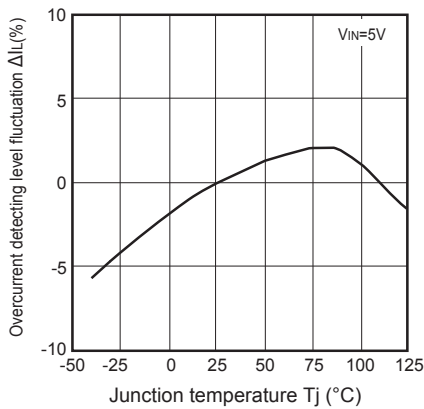

Fig.9 Output Saturation Voltage vs. Voltage between Vb and Vout

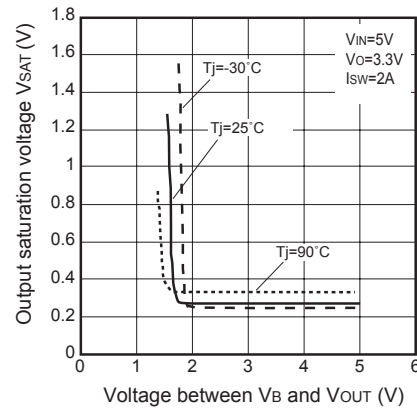

Fig.10 Operating Dissipation Current vs. Input Voltage

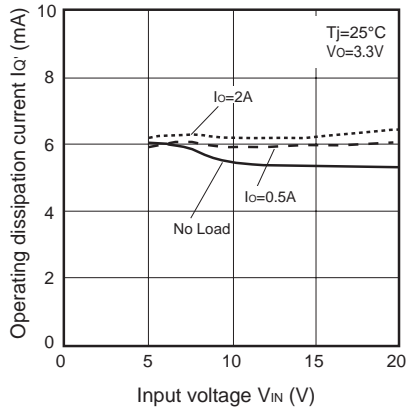

Fig.11 Line Regulation vs. Input Voltage

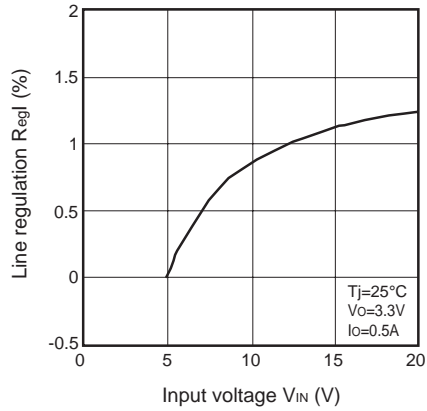

Fig.12 Load Regulation vs. Output Current

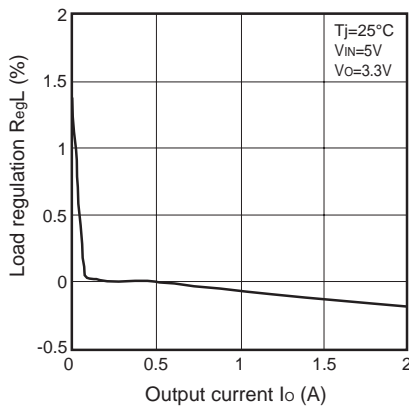

Fig.13 Threshold Voltage vs. Junction Temperature

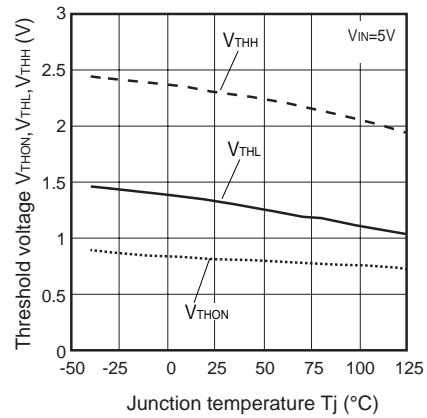

Fig.14 Maximum Duty vs. Junction Temperature

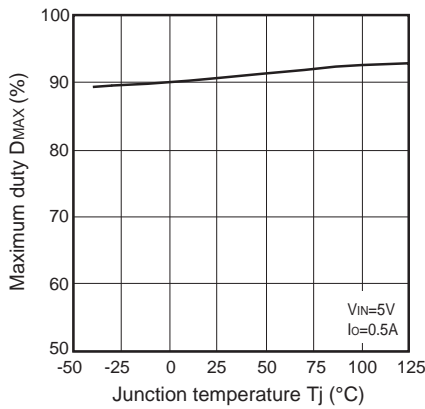

Fig.15 VB Terminal Current vs. Switching Current

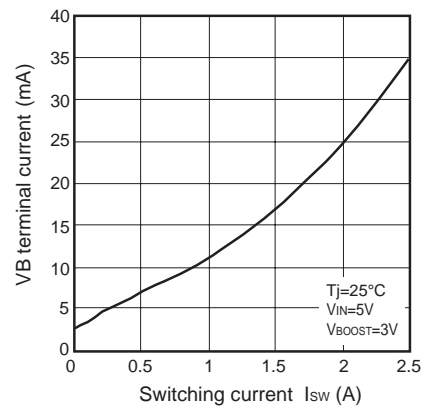
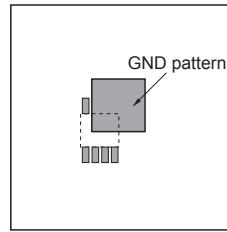
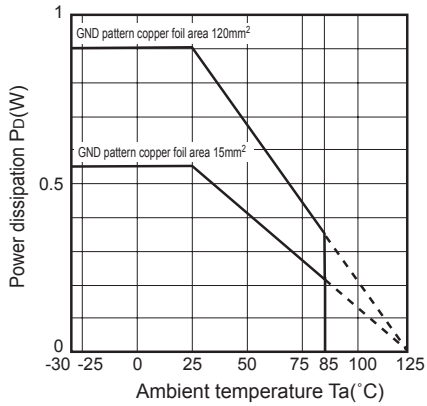

Fig.16 PD-Ta rating(Typical value)



Mounting PCB

Material : Glass-cloth epoxy resin
 Size : 30mm × 30mm × 1mm
 GND pattern copper foil area : 120mm²,35μm

■ Block Diagram

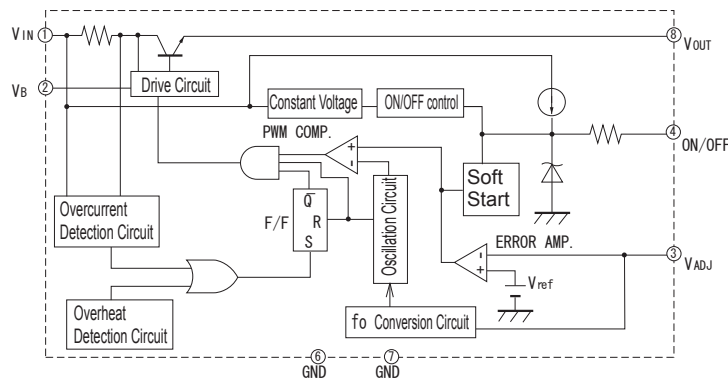

■ Step-down voltage output circuit diagram

