

The BP5232A25, BP5232A33, BP5233A33, BP5234A33 are DC/DC converters that use PWM system and VFM system. They contain control circuits, switching devices and coils, and operate by only connecting an I/O smoothing capacitor. With a high efficiency of power conversion, the modules are available in stand-alone SIP packages with no heat sink required.

●Applications

Power supplies for copiers, personal computers, facsimiles, industrial equipment, and AV equipment.

●Features

- 1) High power conversion efficiency. (BP5233A33 : 93%)
- 2) Large output current.
- 3) Low current consumption with no load.
(BP5233A33 : 200 μ A Typ.)
- 4) High conversion efficiency. (85% at output current of 100mA)
- 5) Applicable to various purposes by fine-adjusting output voltage with external circuits.
- 6) Built-in ON / OFF switch.
- 7) Heat sink unnecessary.

●Dimensions (Unit : mm)

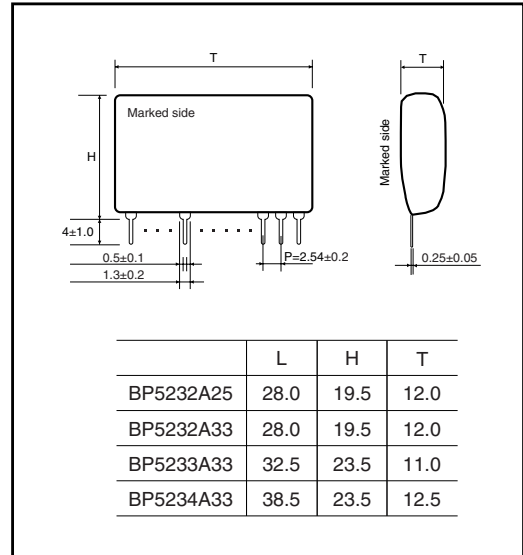

●Absolute maximum ratings (Ta=25°C)

Parameter	Symbol	Limits				Unit
		BP5232A25	BP5232A33	BP5233A33	BP5234A33	
Input voltage	V _{IN}	7				V
Output current	I _o	2*	2*	3*	4*	A
Operating temperature	T _{opr}	-20 to +55				°C
Storage temperature	T _{stg}	-25 to +80				°C

* Derating required according to the input voltage and ambient temperature.

●Recommended operating conditions (Ta=25°C)

Parameter	Symbol	Min.	Typ.	Max.	Unit
Input voltage	V _{IN}	4.5	5.0	5.5	V

● Block diagram

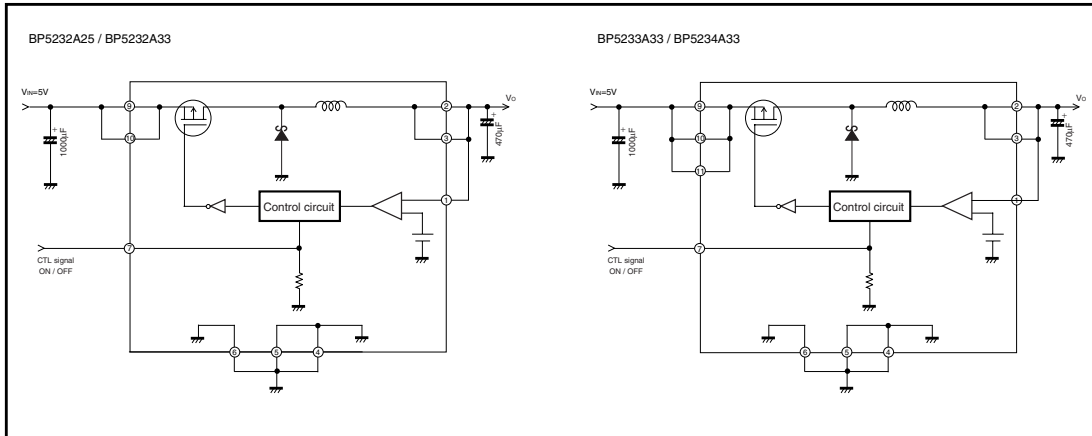

● Pin descriptions

BP5232A25 , 5232A33

Pin No.	Pin description	Pin No.	Pin description
1	Feed back	6	GND
2	V _{OUT1}	7	CTL
3	V _{OUT2}	9	V _{IN1}
4	GND	10	V _{IN2}
5	GND		

Pin 8 is removed.

BP5233A33 , BP5234A33

Pin No.	Pin description	Pin No.	Pin description
1	Feed back	6	GND
2	V _{OUT1}	7	CTL
3	V _{OUT2}	9	V _{IN1}
4	GND	10	V _{IN2}
5	GND	11	V _{IN3}

Pin 8 is removed.

● Electrical characteristics

BP5232A25 (Unless otherwise noted, V_{IN}=5V, I_o=1A, SW=1, T_a=25°C)

Parameter	Symbol	Min.	Typ.	Max.	Unit	Conditions	Measurement circuit
Input voltage	V _{IN}	4.5	5	5.5	V	DC	Fig.1
Output voltage	V _O	2.4	2.5	2.6	V		Fig.1
Output current	I _o	-	-	2	A	*1	Fig.1
Current consumption at no load	I _{IN}	-	200	300	µA	I _o =0A	Fig.1
Load regulation	ΔV _O	-	13	33	mV	I _o =0.1A to 2A	Fig.1
Output ripple voltage	v _γ	-	33	100	mV _{PP}	*2	Fig.1
Power conversion efficiency	η	84	89	-	%		Fig.1
CTL pin ON voltage	V _{ON}	1.8	-	-	V	SW=2	Fig.1
CTL pin OFF voltage	V _{OFF}	-	-	0.3	V	SW=2	Fig.1

*1 Derating required according to the input voltage and ambient temperature.

*2 Pulse noise not included.

BP5232A33 (Unless otherwise noted, $V_{IN}=5V$, $I_O=1A$, $SW=1$, $T_a=25^\circ C$)

Parameter	Symbol	Min.	Typ.	Max.	Unit	Conditions	Measurement circuit
Input voltage	V_{IN}	4.5	5	5.5	V	DC	Fig.1
Output voltage	V_O	3.17	3.3	3.43	V		Fig.1
Output current	I_O	–	–	2	A	*1	Fig.1
Current consumption at no load	I_{IN}	–	200	300	μA	$I_O=0A$	Fig.1
Load regulation	ΔV_O	–	16	42	mV	$I_O=0.1A$ to 2A	Fig.1
Output ripple voltage	v_γ	–	33	100	mV _{PP}		Fig.1
Power conversion efficiency	η	88	93	–	%		Fig.1
CTL pin ON voltage	V_{ON}	1.8	–	–	V	$SW=2$	Fig.1
CTL pin OFF voltage	V_{OFF}	–	–	0.3	V	$SW=2$	Fig.1

*1 Maximum output current must be reduced by ambient temperature.

BP5233A33 (Unless otherwise noted, $V_{IN}=5V$, $I_O=1.5A$, $SW=1$, $T_a=25^\circ C$)

Parameter	Symbol	Min.	Typ.	Max.	Unit	Conditions	Measurement circuit
Input voltage	V_{IN}	4.5	5	5.5	V	DC *2	Fig.2
Output voltage	V_O	3.17	3.3	3.43	V		Fig.2
Output current	I_O	–	–	3	A	*1, 4	Fig.2
Current consumption at no load	I_{IN}	–	200	300	μA	$I_O=0A$	Fig.2
Load regulation	ΔV_O	–	16	42	mV	$I_O=0.1A$ to 3A	Fig.2
Output ripple voltage	v_γ	–	33	150	mV _{PP}	*3	Fig.2
Power conversion efficiency	η	88	93	–	%		Fig.2
CTL pin ON voltage	V_{ON}	1.8	–	–	V	$SW=2$	Fig.2
CTL pin OFF voltage	V_{OFF}	–	–	0.3	V	$SW=2$	Fig.2

*1 Maximum output current must be reduced by ambient temperature.

*2 Give the start time of input as 5ms within.

*3 An output ripple voltage sometimes changes in capacitor to use, the measurement environment.

*4 There is restriction in use time, in the case that the output current is 2.5A over.

Please refer to "the passage output current characteristic" of later description.

BP5234A33 (Unless otherwise noted, $V_{IN}=5V$, $I_O=2A$, $SW=1$, $T_a=25^\circ C$)

Parameter	Symbol	Min.	Typ.	Max.	Unit	Conditions	Measurement circuit
Input voltage	V_{IN}	4.5	5	5.5	V	DC	Fig.2
Output voltage	V_O	3.17	3.3	3.43	V		Fig.2
Output current	I_O	–	–	4	A	*1, 3	Fig.2
Current consumption at no load	I_{IN}	–	300	400	μA	$I_O=0A$	Fig.2
Load regulation	ΔV_O	–	16	42	mV	$I_O=0.1A$ to 4A	Fig.2
Output ripple voltage	v_γ	–	33	150	mV _{PP}	*2	Fig.2
Power conversion efficiency	η	88	93	–	%		Fig.2
CTL pin ON voltage	V_{ON}	1.8	–	–	V	$SW=2$	Fig.2
CTL pin OFF voltage	V_{OFF}	–	–	0.3	V	$SW=2$	Fig.2

*1 Maximum output current must be reduced by ambient temperature.

*2 Give the start time of input as 5ms within.

*3 An output ripple voltage sometimes changes in capacitor to use, the measurement environment.

● Measurement circuit

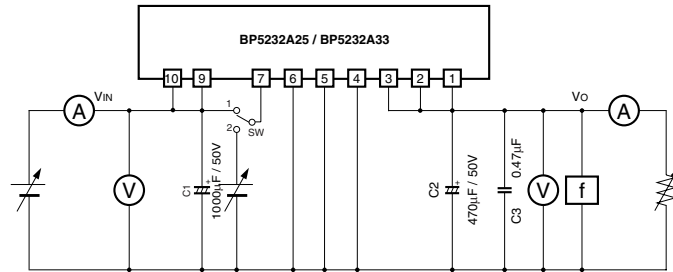

f : frequency counter
 C1, C2 : Low impedance type
 C3 : film capacitor

→A large ripple current flows to the input smoothing capacitor due to the output load. Be minded to use within the allowable ripple current of the capacitor.
 →The capacitor with a particularly low impedance is used as the output smoothing capacitor C2 so as to suppress the output ripple voltage. Select the capacitor according to the purpose of use in each case.

Fig.1

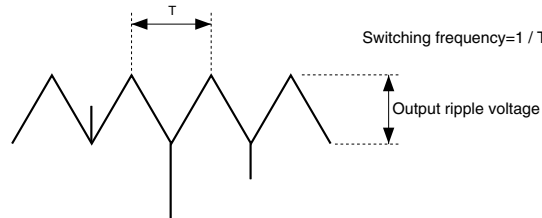

Note that the output ripple voltage depends on the type and characteristics of the output capacitor.

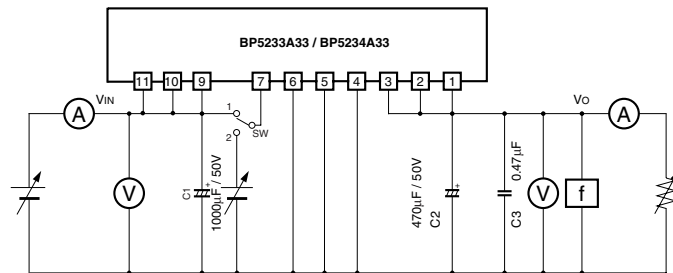

f : frequency counter
 C1, C2 : Low impedance type
 C3 : film capacitor

→A large ripple current flows to the input smoothing capacitor due to the output load. Be minded to use within the allowable ripple current of the capacitor.
 →The capacitor with a particularly low impedance is used as the output smoothing capacitor C2 so as to suppress the output ripple voltage. Select the capacitor according to the purpose of use in each case.

Fig.2

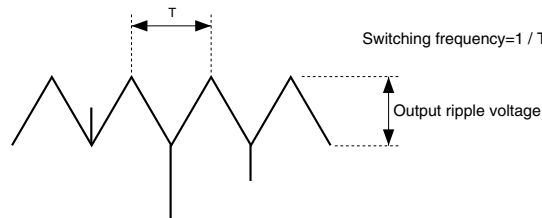

Note that the output ripple voltage depends on the type and characteristics of the output capacitor.

● Circuit operation

- (1) The basic application examples are shown in Fig.3. The externally installed parts are only the input and output smoothing capacitors.
- (2) Switching on and off the output voltage is allowed. The output can be switched off by making pin 7 to be low or open (high impedance). (See Fig.4)
- (3) Fine adjustment of the output voltage is allowed. The fine adjustment of output voltage can be performed from pin 1 via the resistor by connecting the output terminal (pin2, 3) and GND. (See Fig.5)
- (4) Be sure to use a fuse for the safety.

Basic application

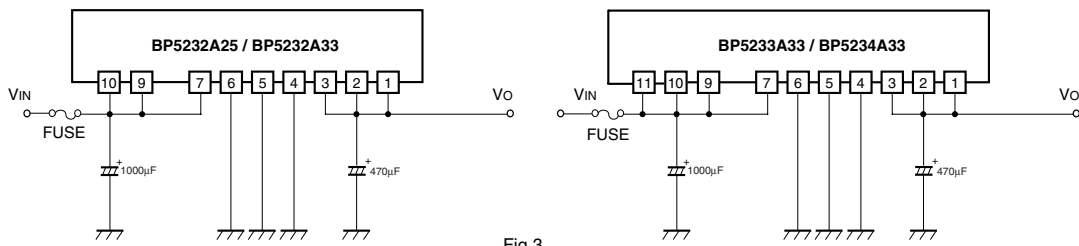

Fig.3

Output ON / OFF control

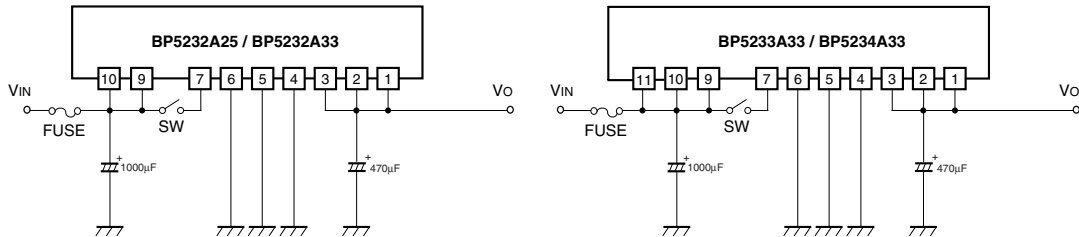
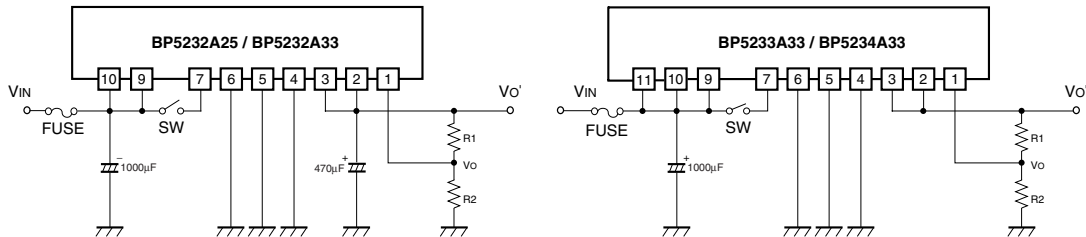

Fig.4

Output voltage fine adjustment



Vo' value setting equations

$$Vo' = Vo \left(1 + \frac{R1}{R2} \right) \quad R1 + R2 \leq 50k\Omega$$

It is recommended that the output voltage should be adjusted within the range of $\pm 10\%$ of the rated output voltage, so that the performance of the module can fully be exhibited.

Fig.5

● Operation notes

- (1) The output current should be reduced according to an increase in the input voltage or ambient temperature. Use the module within the derating curve range.
- (2) In case that the output is controlled by switching on and off utilizing pin 7 or in case that the input voltage is applied, a large inrush electrical current may flow. Be minded to use within the allowable operating range. This allowable operating range is specified by the safety operating range of the switching transistor in the module. The amount of the inrush current varies depending on the output impedance of the input power supply or the capacity value of the capacitor to be connected to the output.
- (3) Protection circuit for output current is incorporated. In case that the output is short-circuited, the output will be latched by switching off. The protection circuit can be canceled by making CTL terminal active state (CTL=HIGH), after once making it standby state (CTL=LOW), or by resupplying the power. However, in case that the protection circuit is canceled by resupplying the power source, it may not be canceled even by resupplying the power source in the state that the electrical charge is remained in CIN (the state that voltage is remained in VIN) even after the power source is switched off.
- (4) The rising time of the input voltage should be made within 5ms. There may be a case that the protection circuit is activated.
- (5) I / O smoothing capacitors should be connected between I / O and GND terminals.
- (6) Normally, use by short-circuiting pins 1, 2, 3, pins 4, 5, 6, and pins 9, 10, 11 (BP5232A25) respectively.
- (7) A large ripple current flows to the input smoothing capacitor due to the output load. Be minded to use within the allowable ripple current of the capacitor.
- (8) The capacitor with a particularly low impedance is used as the output smoothing capacitor C2 so as to suppress the output ripple voltage. Select the capacitor according to the purpose of use in each case.

● Electrical characteristics

BP5232A25

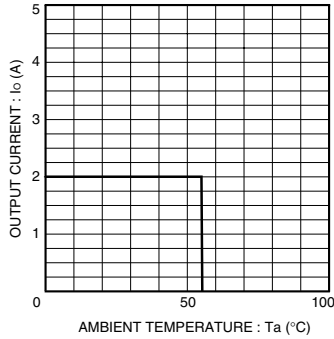

Fig.6 Derating curve

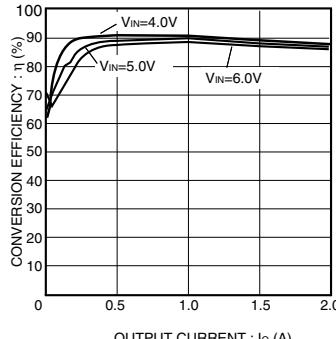

Fig.7 Conversion efficiency

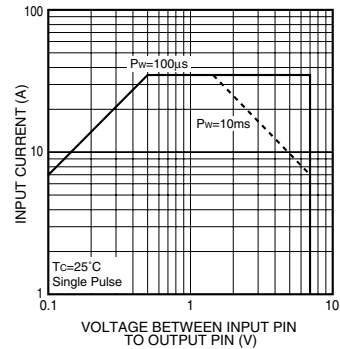

Fig.8 Safe operation range

BP5232A33

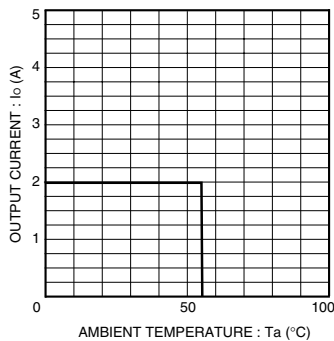

Fig.9 Derating curve

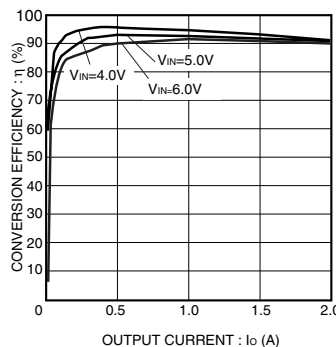

Fig.10 Conversion efficiency

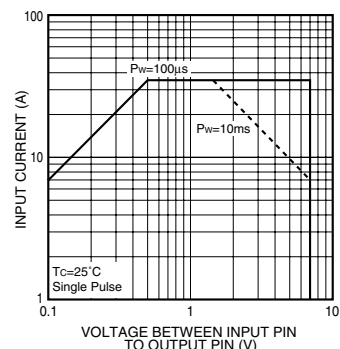

Fig.11 Safe operation range

BP5233A33

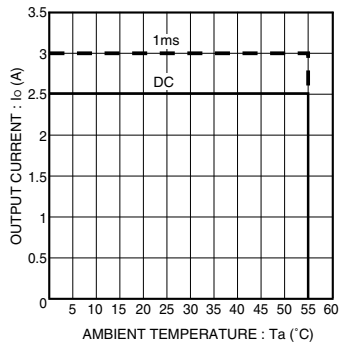

Fig.12 Derating curve

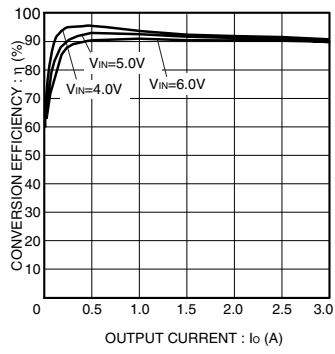

Fig.13 Conversion efficiency

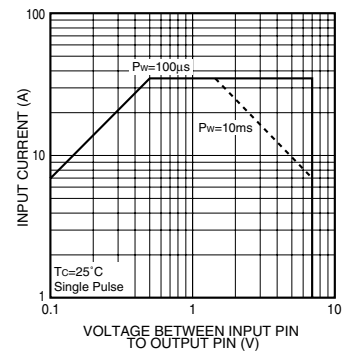

Fig.14 Safe operation range

BP5234A33

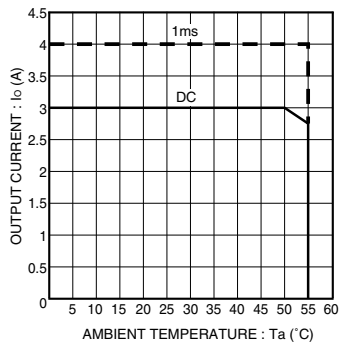

Fig.15 Derating curve

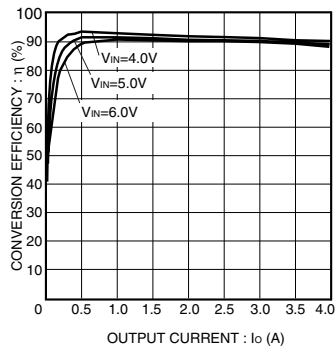

Fig.16 Conversion efficiency

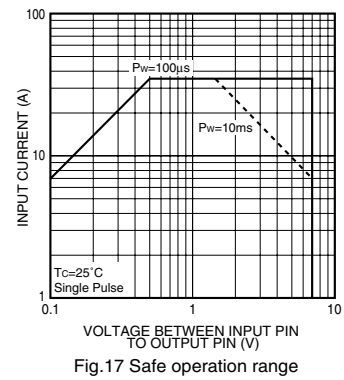

Fig.17 Safe operation range

Notes

- No technical content pages of this document may be reproduced in any form or transmitted by any means without prior permission of ROHM CO.,LTD.
- The contents described herein are subject to change without notice. The specifications for the product described in this document are for reference only. Upon actual use, therefore, please request that specifications to be separately delivered.
- Application circuit diagrams and circuit constants contained herein are shown as examples of standard use and operation. Please pay careful attention to the peripheral conditions when designing circuits and deciding upon circuit constants in the set.
- Any data, including, but not limited to application circuit diagrams information, described herein are intended only as illustrations of such devices and not as the specifications for such devices. ROHM CO.,LTD. disclaims any warranty that any use of such devices shall be free from infringement of any third party's intellectual property rights or other proprietary rights, and further, assumes no liability of whatsoever nature in the event of any such infringement, or arising from or connected with or related to the use of such devices.
- Upon the sale of any such devices, other than for buyer's right to use such devices itself, resell or otherwise dispose of the same, no express or implied right or license to practice or commercially exploit any intellectual property rights or other proprietary rights owned or controlled by
- ROHM CO., LTD. is granted to any such buyer.
- Products listed in this document are no antiradiation design.

The products listed in this document are designed to be used with ordinary electronic equipment or devices (such as audio visual equipment, office-automation equipment, communications devices, electrical appliances and electronic toys).

Should you intend to use these products with equipment or devices which require an extremely high level of reliability and the malfunction of which would directly endanger human life (such as medical instruments, transportation equipment, aerospace machinery, nuclear-reactor controllers, fuel controllers and other safety devices), please be sure to consult with our sales representative in advance.

About Export Control Order in Japan

Products described herein are the objects of controlled goods in Annex 1 (Item 16) of Export Trade Control Order in Japan.

In case of export from Japan, please confirm if it applies to "objective" criteria or an "informed" (by MITI clause) on the basis of "catch all controls for Non-Proliferation of Weapons of Mass Destruction.