

1.1MHz, 650mA SYNCHRONOUS DC-DC BUCK CONVERTER AP3406

General Description

The AP3406 is a 1.1MHz fixed frequency, current mode, PWM synchronous buck (step-down) DC-DC converter, capable of driving a 650mA load with high efficiency, excellent line and load regulation. The device integrates a main switch and a synchronous switch without an external Schottky diode. It is ideal for powering portable equipment that runs from a single Li-ion battery.

A standard series of inductors are available from several different manufacturers optimized for use with the AP3406. This feature greatly simplifies the design of switch-mode power supplies.

This IC is available in TSOT-23-5 and SOT-23-5 packages.

Features

- High Efficiency: up to 95%
- Output Current: 650mA
- Input Voltage Range: 2.5V to 5.5V
- Fixed 1.1MHz Frequency
- Current Mode Control
- 100% Duty Cycle in Dropout
- Built-in Short Circuit Protection
- Built-in Thermal Shutdown Function
- Built-in Current Limit Function
- Shutdown Current: $<1\mu\text{A}$

Applications

- GPS
- WiFi Card
- Portable Media Player
- Digital Still and Video Cameras

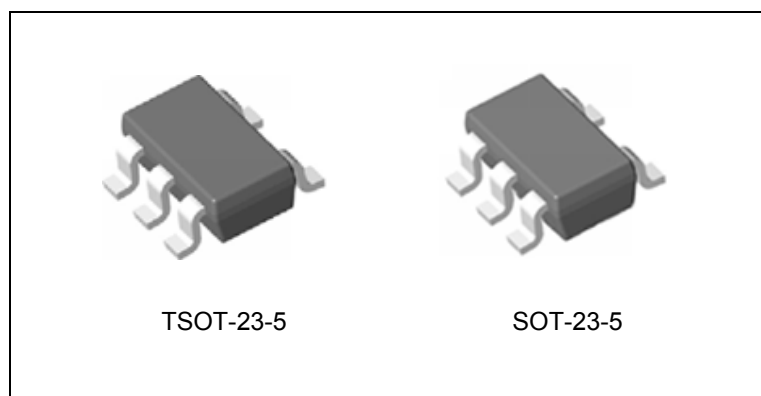


Figure 1. Package Types of AP3406

1.1MHz, 650mA SYNCHRONOUS DC-DC BUCK CONVERTER AP3406
Pin Configuration

KT/K Package
TSOT-23-5/SOT-23-5

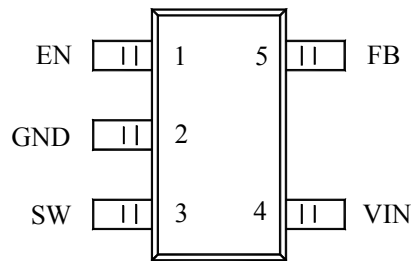


Figure 2. Pin Configuration of AP3406 (Top View)

Pin Description

Pin Number	Pin Name	Function
1	EN	Control input pin. Forcing this pin above 1.5V enables the IC. Forcing this pin below 0.6V shuts down the IC. When the IC is in shutdown mode, all functions are disabled to decrease the supply current below 1 μ A
2	GND	Ground pin
3	SW	Power switch output pin. Inductor connection to drain of the internal PFET and NFET switches
4	VIN	Supply input pin. Bypass to GND with a 4.7 μ F or greater ceramic capacitor
5	FB	Feedback pin. Connect it with an external resistor divider network to program the system output voltage

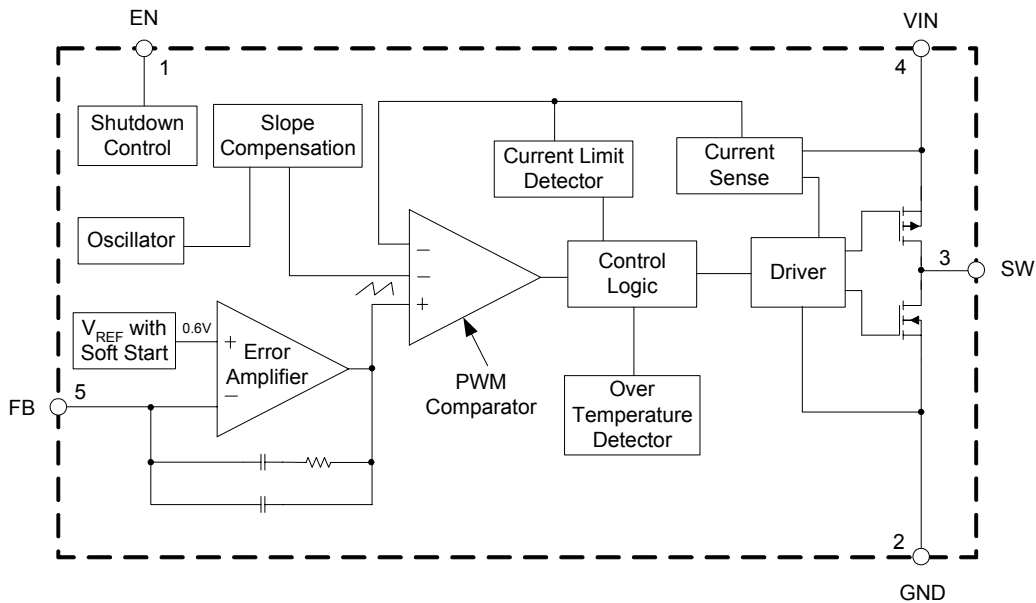
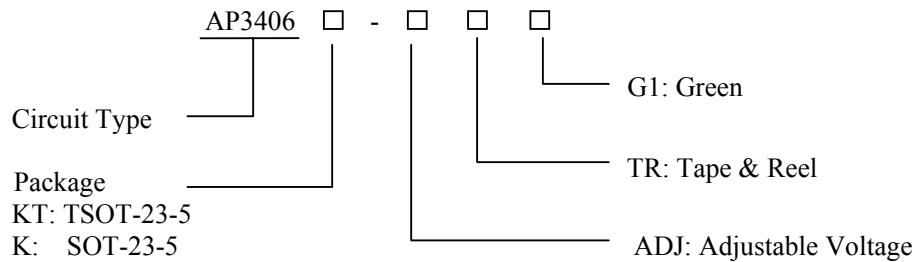
1.1MHz, 650mA SYNCHRONOUS DC-DC BUCK CONVERTER AP3406
Functional Block Diagram


Figure 3. Functional Block Diagram of AP3406

Ordering Information


Package	Temperature Range	Part Number	Marking ID	Packing Type
		Green	Green	
TSOT-23-5	-40 to 85°C	AP3406KT-ADJTRG1	L1B	Tape & Reel
SOT-23-5	-40 to 85°C	AP3406K-ADJTRG1	FBC	Tape & Reel

BCD Semiconductor's Pb-free products, as designated with "E1" suffix in the part number, are RoHS compliant. Products with "G1" suffix are available in green packages.

**1.1MHz, 650mA SYNCHRONOUS DC-DC BUCK CONVERTER AP3406****Absolute Maximum Ratings (Note 1)**

Parameter	Symbol	Value	Unit	
Input Voltage	V_{IN}	-0.3 to 6	V	
Feedback Voltage	V_{FB}	-0.3 to $V_{IN}+0.3$	V	
EN Pin Voltage	V_{EN}	-0.3 to $V_{IN}+0.3$	V	
SW Pin Voltage	V_{SW}	-0.3 to $V_{IN}+0.3$	V	
Thermal Resistance	θ_{JA}	TSOT-23-5	250	°C/W
		SOT-23-5	265	
Operating Junction Temperature	T_J	125	°C	
Storage Temperature	T_{STG}	-65 to 150	°C	
Lead Temperature (Soldering, 10sec)	T_{LEAD}	260	°C	

Note 1: Stresses greater than those listed under “Absolute Maximum Ratings” may cause permanent damage to the device. These are stress ratings only, and functional operation of the device at these or any other conditions beyond those indicated under “Recommended Operating Conditions” is not implied. Exposure to “Absolute Maximum Ratings” for extended periods may affect device reliability.

Recommended Operating Conditions

Parameter	Symbol	Min	Max	Unit
Input Voltage	V_{IN}	2.5	5.5	V
Maximum Output Current	$I_{OUT(MAX)}$	650		mA
Operating Ambient Temperature	T_A	-40	85	°C



1.1MHz, 650mA SYNCHRONOUS DC-DC BUCK CONVERTER AP3406

Electrical Characteristics

$V_{IN}=V_{EN}=3.6V$, $T_A=25^\circ$, unless otherwise specified. Specifications with **boldface type** apply over full operating temperature range from -40 to $85^\circ C$.

Parameters	Symbol	Conditions	Min	Typ	Max	Unit
Supply Current	I_{CC}	$V_{FB}=0.55V$		400	600	μA
Shutdown Supply Current	I_{SHDN}	$V_{EN}=0V$, $V_{IN}=5.5V$		0.01	1	μA
Under Voltage Lockout Threshold	V_{UVLO}	Rising edge	2.10	2.27	2.45	V
Under Voltage Lockout Hysteresis	V_{HUVLO}			200		mV
Feedback Bias Current	I_{FB}	$V_{FB}=0.65V$	-50	0.5	50	nA
Feedback Voltage	V_{FB}	$I_{OUT}=100mA$	0.588/ 0.582	0.600	0.612/ 0.618	V
Maximum Output Current	$I_{OUT(MAX)}$	$V_{IN}=2.5V$, $V_{OUT}=0.9V$	650			mA
		$V_{IN}=3.6V$, $V_{OUT}=1.2V$	650			
		$V_{IN}=4.6V$, $V_{OUT}=3.3V$	650			
Switch Current Limit	I_{LIM}	$V_{FB}=0.55V$	0.85	1.15		A
Oscillator Frequency	f_{OSC}		0.8	1.1	1.4	MHz
EN Pin Threshold	V_{ENL}				0.6	V
	V_{ENH}		1.5			
EN Pin Input Leakage Current	I_H	$V_{EN}=3.6V$	-0.1		0.1	μA
	I_L	$V_{EN}=0V$	-0.1		0.1	μA
Internal PFET On Resistance	R_{DSONP}	$I_{SW}=100mA$		0.44		Ω
Internal NFET On Resistance	R_{DSONN}	$I_{SW}=-100mA$		0.29		Ω
Maximum Duty Cycle	D_{MAX}	$V_{FB}=0.55V$		100		%
Soft-start Time	T_{SS}	$V_{EN}=0V$ to V_{IN} $I_{OUT} = 50mA$		220		μs
Thermal Shutdown Threshold	T_{OTSD}			160		$^\circ C$
Thermal Shutdown Hysteresis	T_{HYS}			30		$^\circ C$



1.1MHz, 650mA SYNCHRONOUS DC-DC BUCK CONVERTER AP3406

Typical Performance Characteristics

$L=10\mu\text{H}$, $C_{\text{OUT}}=10\mu\text{F}$, $T_{\text{A}}=25^{\circ}\text{C}$, unless otherwise noted.

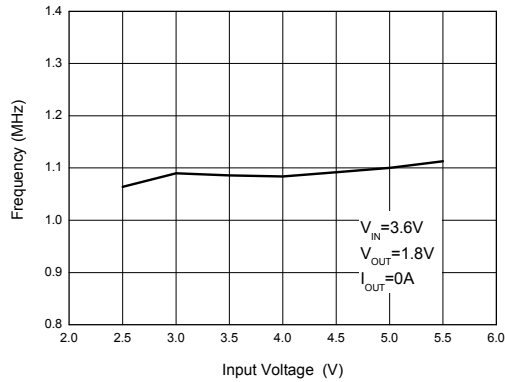


Figure 4. Frequency vs. Input Voltage

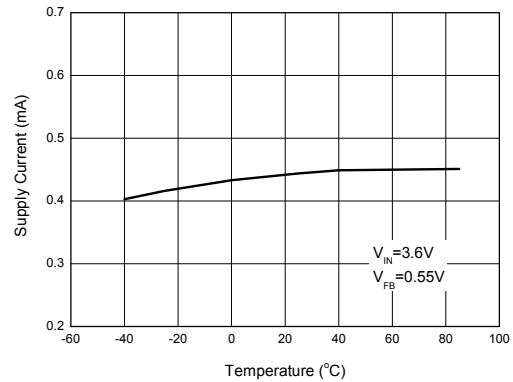


Figure 5. Supply Current vs. Temperature

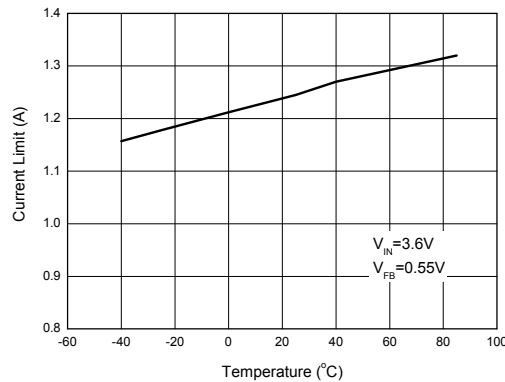


Figure 6. Current Limit vs. Temperature

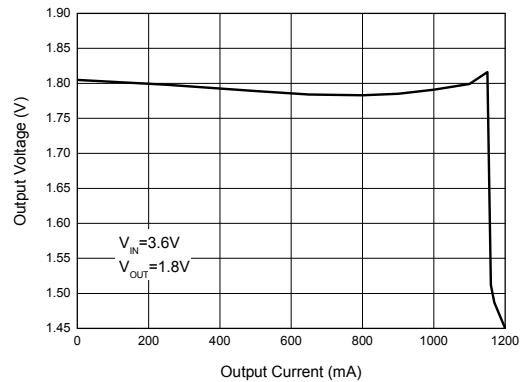


Figure 7. Output Voltage vs. Output Current

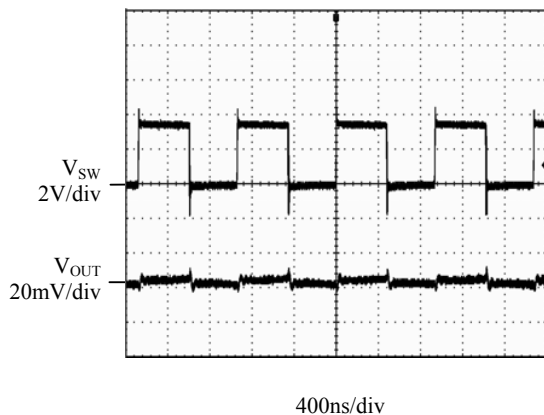
1.1MHz, 650mA SYNCHRONOUS DC-DC BUCK CONVERTER AP3406
Typical Performance Characteristics (Continued)


Figure 8. Light Load Operation
 ($V_{IN}=3.6V$, $V_{OUT}=1.8V$, $I_{OUT}=0mA$)

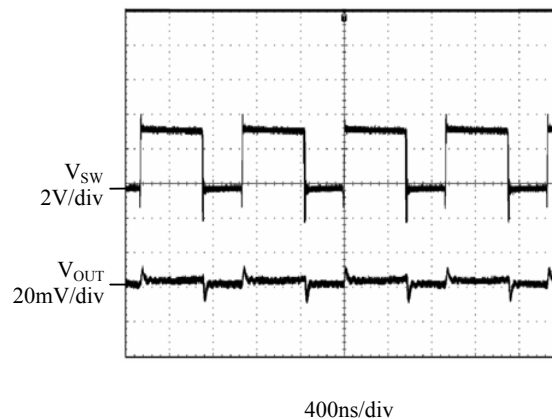


Figure 9. Heavy Load Operation
 ($V_{IN}=3.6V$, $V_{OUT}=1.8V$, $I_{OUT}=600mA$)

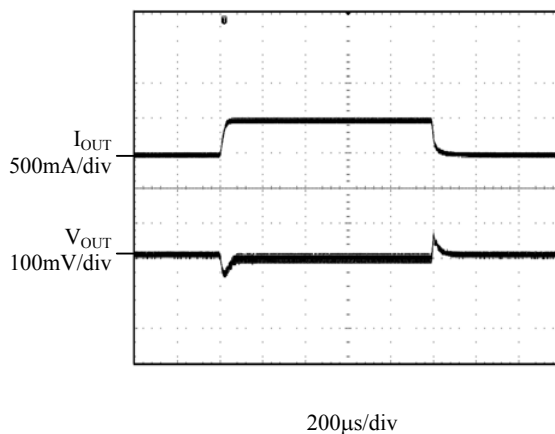


Figure 10. Load Transient
 ($V_{IN}=3.6V$, $V_{OUT}=1.8V$, $I_{OUT}=0mA$ to $500mA$)

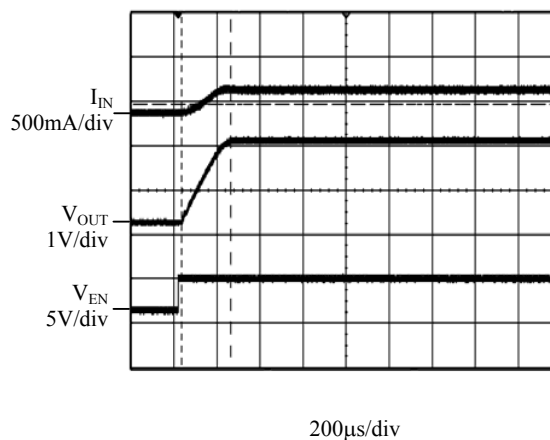


Figure 11. Start up from Shutdown
 ($V_{IN}=3.6V$, $V_{OUT}=1.8V$, $R_{LOAD}=4\Omega$)

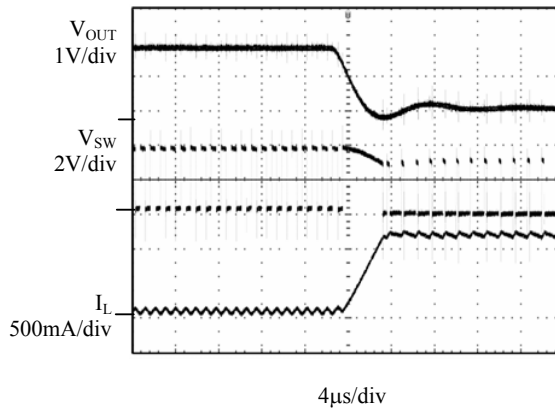
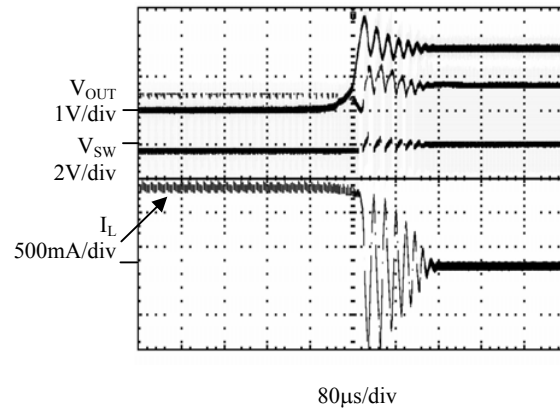
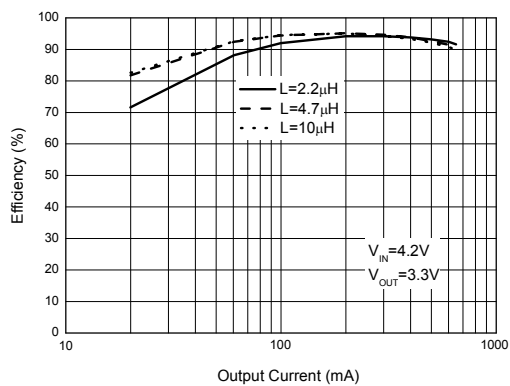
1.1MHz, 650mA SYNCHRONOUS DC-DC BUCK CONVERTER AP3406
Typical Performance Characteristics (Continued)

 Figure 12. Short Circuit Protection
 ($V_{IN}=3.6V$, $V_{OUT}=1.8V$, no load)

 Figure 13. Short Circuit Recovery
 ($V_{IN}=3.6V$, $V_{OUT}=1.8V$, no load)


Figure 14. Efficiency vs. Output Current

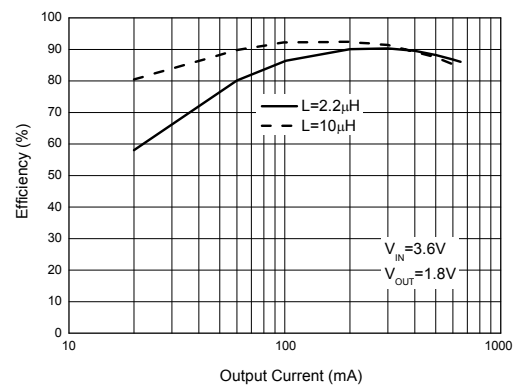


Figure 15. Efficiency vs. Output Current

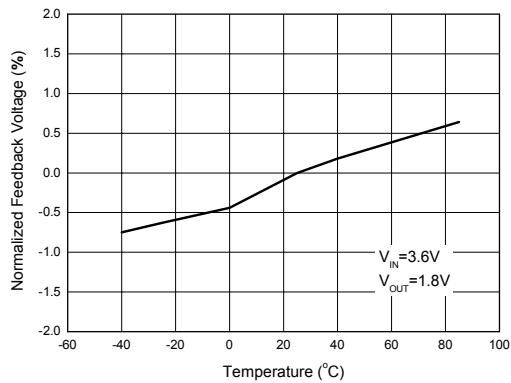
1.1MHz, 650mA SYNCHRONOUS DC-DC BUCK CONVERTER AP3406
Typical Performance Characteristics (Continued)


Figure 16. Normalized Feedback Voltage vs. Temperature

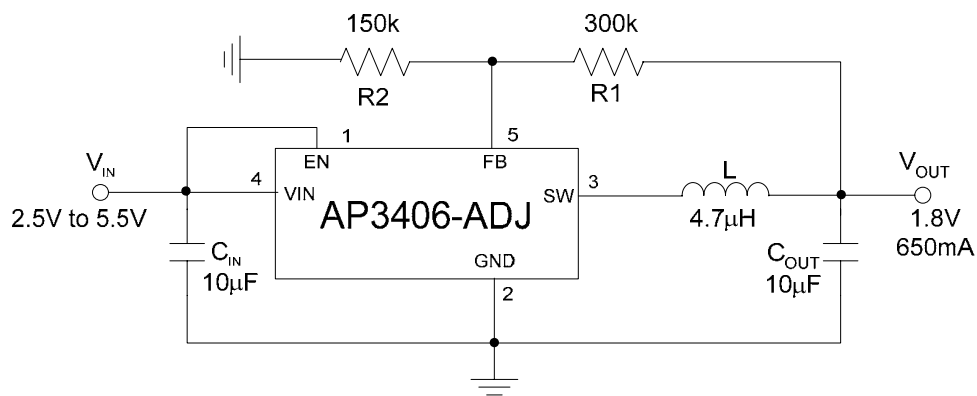
Typical Application


Figure 17. Typical Application of AP3406

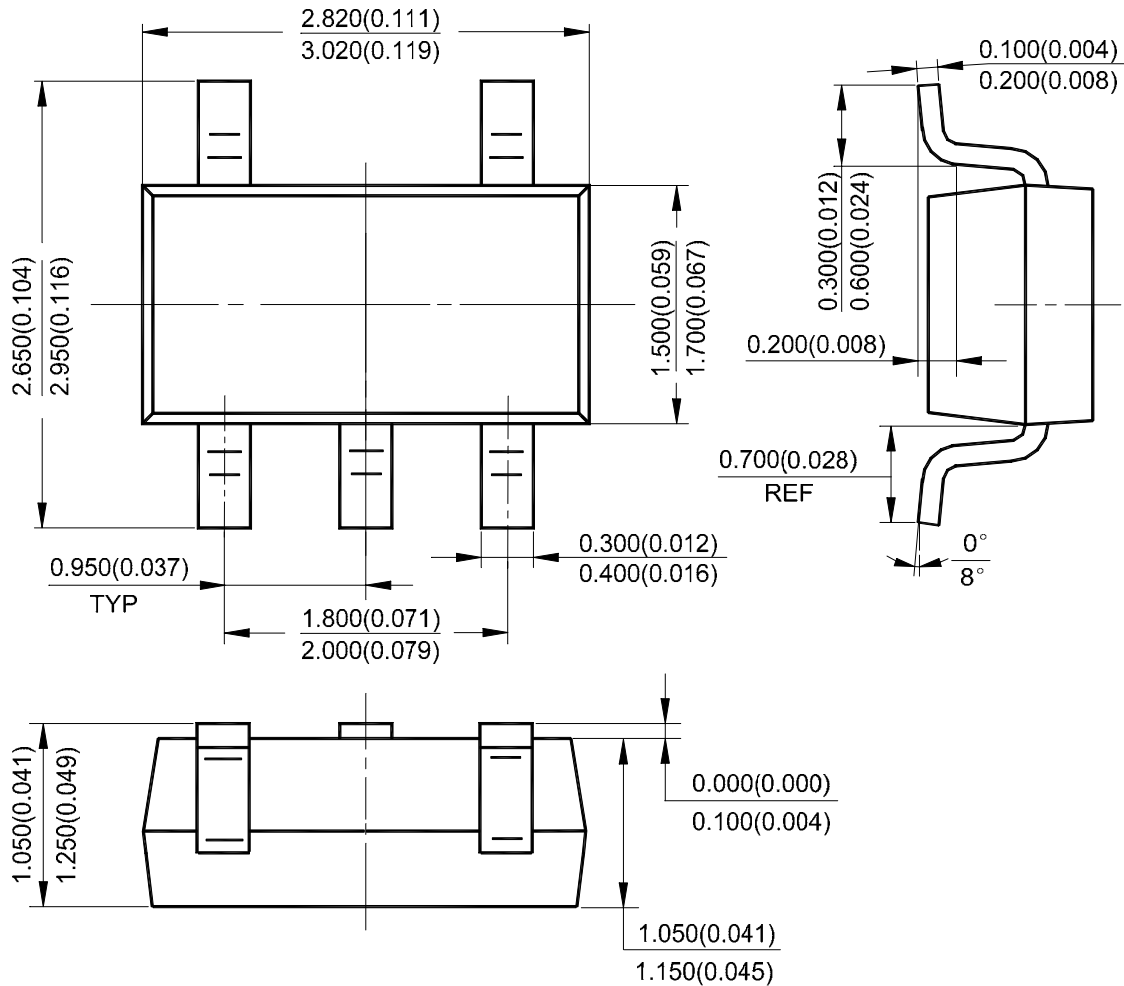


1.1MHz, 650mA SYNCHRONOUS DC-DC BUCK CONVERTER AP3406

Mechanical Dimensions

SOT-23-5

Unit: mm(inch)



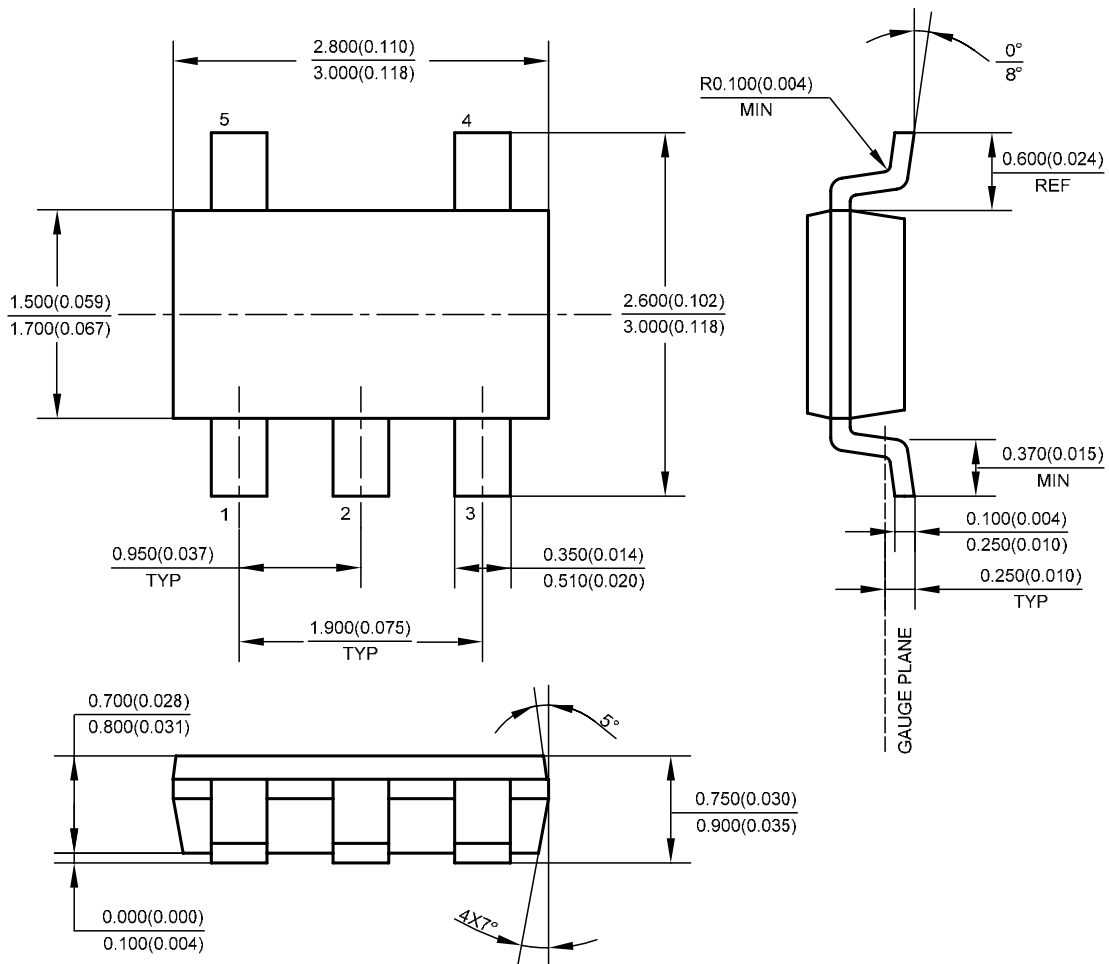


1.1MHz, 650mA SYNCHRONOUS DC-DC BUCK CONVERTER AP3406

Mechanical Dimensions (Continued)

TSOT-23-5

Unit: mm(inch)





BCD Semiconductor Manufacturing Limited

<http://www.bcdsemi.com>

IMPORTANT NOTICE

BCD Semiconductor Manufacturing Limited reserves the right to make changes without further notice to any products or specifications herein. BCD Semiconductor Manufacturing Limited does not assume any responsibility for use of any its products for any particular purpose, nor does BCD Semiconductor Manufacturing Limited assume any liability arising out of the application or use of any its products or circuits. BCD Semiconductor Manufacturing Limited does not convey any license under its patent rights or other rights nor the rights of others.

MAIN SITE

- Headquarters
BCD Semiconductor Manufacturing Limited
No. 1600, Zi Xing Road, Shanghai Zizhu Science-based Industrial Park, 200241, China
Tel: +86-21-24162266, Fax: +86-21-24162277

- Wafer Fab
Shanghai SIM-BCD Semiconductor Manufacturing Co., Ltd.
800 Yi Shan Road, Shanghai 200233, China
Tel: +86-21-6485 1491, Fax: +86-21-5450 0008

REGIONAL SALES OFFICE

Shenzhen Office
Shanghai SIM-BCD Semiconductor Manufacturing Co., Ltd., Shenzhen Office
Room E, 5F, Noble Center, No.1006, 3rd Fuzhong Road, Futian District, Shenzhen, 518026, China
Tel: +86-755-8826 7951
Fax: +86-755-8826 7865

Taiwan Office
BCD Semiconductor (Taiwan) Company Limited
4F, 298-1, Rui Guang Road, Nei-Hu District, Taipei, Taiwan
Tel: +886-2-2656 2808
Fax: +886-2-2656 2806

USA Office
BCD Semiconductor Corp.
30920 Huntwood Ave. Hayward, CA 94544, USA
Tel: +1-510-324-2988
Fax: +1-510-324-2788