

**MICROPOWER 1A LOW DROPOUT
 PMOS VOLTAGE REGULATOR**

FEATURES

- **Stable with Ceramic Capacitor**
- Small, Space Saving MLPM 6-Pin Package
- Guaranteed < 1V Dropout at Full Load Current
- Fast Transient Response
- Ultra-Low Ground Current
- Output Current Limiting
- Built-In Thermal Shutdown

APPLICATIONS

- High Efficiency Linear Regulator
- Hard Disk Drivers, CD-ROMs, DVDs
- ADSL and Cable Modems

DESCRIPTION

The IRU1502-33 is a PMOS low dropout, linear regulator and it is capable of supplying 1A of continuous current over line and temperature range. The IRU1502-33 is stable with low value ceramic capacitors, ensures low noise operation, improves load transient response and enables a smaller circuit size.

IRU1502-33 features ultra low noise, fast start-up and an excellent time and load response. This device also includes built-in output protection with both current limit and thermal shutdown.

TYPICAL APPLICATION

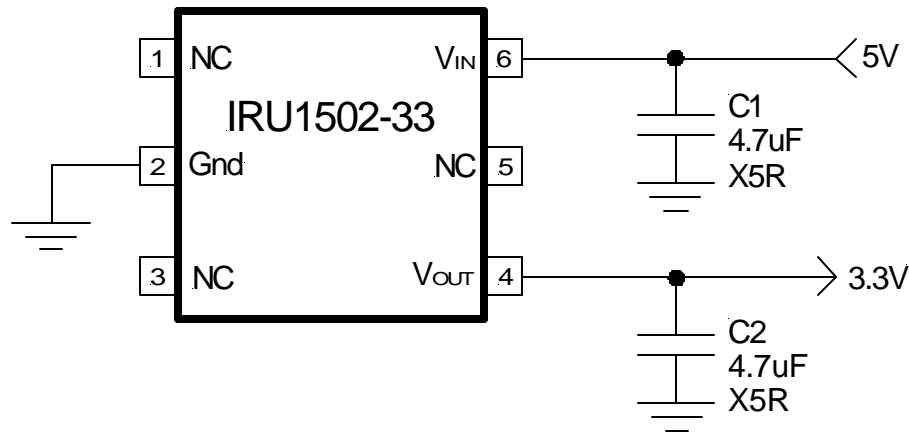

Figure 1 - Typical application of IRU1502-33.

PACKAGE ORDER INFORMATION

T _J (°C)	DEVICE	PACKAGE	MARKING
0 To 125	IRU1502-33CH	6-Pin MLPM 3x3 (H)	1502

ABSOLUTE MAXIMUM RATINGS

Input Voltage (V_{IN}) 6V
 Operating Ambient Temperature Range -40°C To 125°C
 Storage Temperature Range -65°C To 150°C

CAUTION: Stresses above those listed in "Absolute Maximum Ratings" may cause permanent damage to the device.

PACKAGE INFORMATION

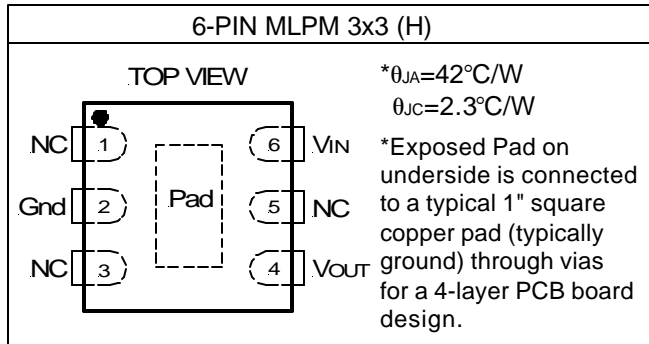

ELECTRICAL SPECIFICATIONS

Unless otherwise specified, these specifications apply over $V_{IN}=4.5V$ to $5.5V$, $I_{OUT}=2mA$ to $1A$, $C_{IN}=10\mu F$, $C_{OUT}=10\mu F$, $0^{\circ}C < T_J < 125^{\circ}C$ and Note 1 and 6.

PARAMETER	SYM	TEST CONDITION	MIN	TYP	MAX	UNITS
Output Voltage 3.3V	$V_{O(3.3)}$	$4.75V < V_{IN} < 5.25V$, $5mA \leq I_o \leq 1A$: $T_J=25^{\circ}C$ $0^{\circ}C \leq T_J \leq 125^{\circ}C$	3.234 3.2175	3.3 3.3	3.366 3.3825	V
Line Regulation	Reg _{LINE}	$4.75V < V_{IN} < 5.25V$, $I_o=5mA$			15	mV
Load Regulation	Reg _{LOAD}	$V_{IN}=4.75V$, $10mA \leq I_o \leq 1A$			100	mV
Dropout Voltage	V_D	$V_{IN}=4V$, $I_o=1A$ $V_{IN}=3.8V$, $I_o=0.8A$, Note 2	3 3		3.3825 3.3825	V
Current Limit	I_S	$V_{IN}=5.5V$	1	1.4		A
Minimum Output Current	$I_{O(MIN)}$	Note 3			2	mA
Temperature Stability	T_S	Note 4, 5		0.5		%
RMS Output Noise	V_N	$10Hz < BW < 10KHz$, Note 5		0.003		% V_o
Ripple Rejection	R_A	$V_{IN}=5V$, $f=120Hz$, Note 5	45	55		dB
Thermal Shutdown	$T_{J(SD)}$	$V_{IN}=4.75V$, $5mA \leq I_o \leq 1A$, Note 5	135			$^{\circ}C$
Quiescent Current	I_{GND}	$V_{IN} \leq 5.5V$, $2mA \leq I_o \leq 1A$			650	μA
Transient Response Step Load Change (light load to full load) Droop Voltage	$\frac{\Delta V_{OUT}}{\Delta I_{OUT}}$	$V_{IN}=5V$, Any 200mA step from 100mA to 1A, $t_r \geq 1\mu s$, Note 5			5	%
Transient Response Step Load Change (full load to light load) Output Voltage	$\frac{\Delta V_{OUT}}{\Delta I_{OUT}}$	$V_{IN}=5V$, 1A to 10mA, $t_r \geq 1\mu s$, Note 5			3.6	V
Transient Response Change of V_{OUT} with Application of V_{IN}	$\frac{\Delta V_{OUT}}{\Delta V_{IN}}$	0 to 5V step input, $t_r \geq 1\mu s$, $10mA \leq I_o \leq 1A$ Note 5			3.6	V
Transient Response Short Circuit Removal Response	$\frac{\Delta V_{OUT}}{\Delta I_{OUT}}$ @ $I_o=Short$	$V_{IN}=5V$, $I_o=I_{SHORT}$ to $I_o=10mA$ Note 5			3.6	V

Note 1: Low duty cycle pulse testing with Kelvin connections is required in order to maintain accurate data.

Note 4: Temperature stability is the change in output from nominal over the operating temperature range.

Note 2: In general, Dropout voltage is defined as the minimum differential voltage between V_{IN} and V_{OUT} required to maintain regulation at V_{OUT} . In this specification, it is the measured output voltage at specified condition.

Note 5: Guaranteed by design, but not tested in production.

Note 3: Minimum load current is defined as the minimum current required at the output in order for the output voltage to maintain regulation.

Note 6: All limits are guaranteed. All electrical characteristics have temperature limits that are tested during $T_A=25^{\circ}\text{C}$ at probing and tested at final production with $T_A=100^{\circ}\text{C}$. All hot and cold limits are guaranteed by correlating the electrical characteristics to process and temperature variations.

PIN DESCRIPTIONS

PIN #	PIN SYMBOL	PIN DESCRIPTION
1,3,5	NC	No connection.
2	Gnd	Ground pin.
4	V_{OUT}	The output of the regulator. A minimum of $4.7\mu\text{F}$ output capacitance must be connected from this pin to ground to insure stability.
6	V_{IN}	The power input pin of the regulator. A minimum of input capacitance must be connected from this pin to ground to insure that the input voltage does not sag below the minimum dropout voltage during the load transient response. This pin must always be higher than the V_{OUT} pin by the amount of dropout voltage (see electrical specification) in order for the device to regulate properly.

BLOCK DIAGRAM

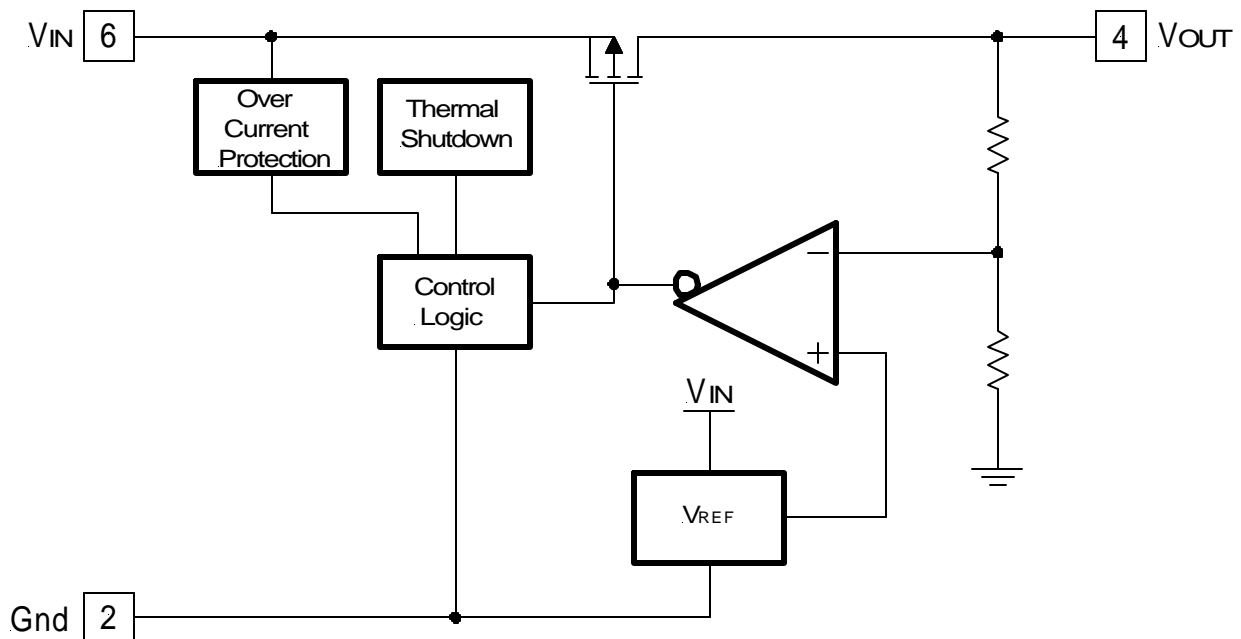

Figure 2 - Simplified block diagram of the IRU1502-33.

TYPICAL PERFORMANCE CHARACTERISTICS

Unless specified, the test data applies: $T_A=25^{\circ}\text{C}$, $C_{IN}=4.7\mu\text{F}$, $C_{OUT}=4.7\mu\text{F}$ ceramic and $V_{IN}=5\text{V}$.

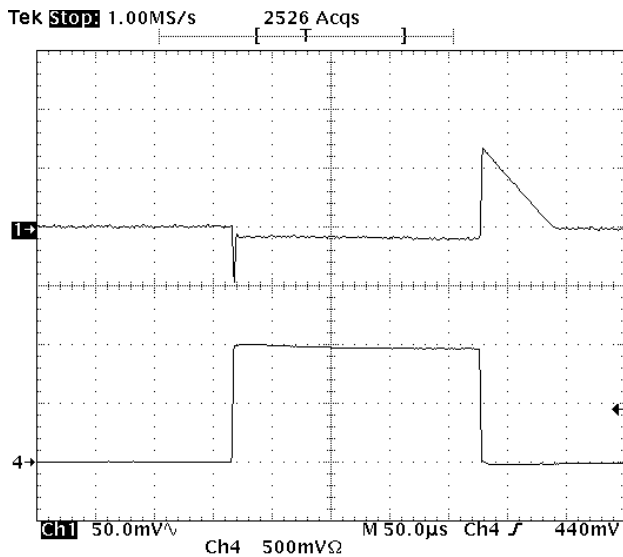

Figure 3 - Step load response from 2mA to 1A, $t_r \geq 1\mu\text{s}$.
 Ch1: Output voltage, AC, 50mV/div
 Ch4: Load Current, 0.5A/div

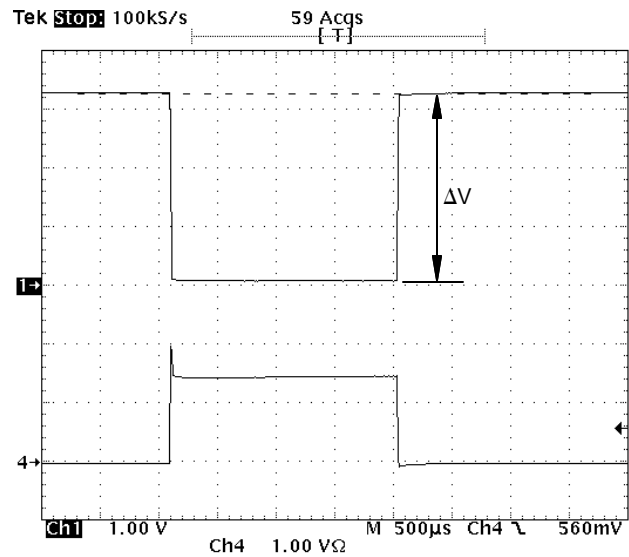

Figure 5 - Output short circuit operation.
 $\Delta V = 3.26\text{V}$
 Ch1: Output voltage, 1V/div
 Ch4: Load Current, 1A/div

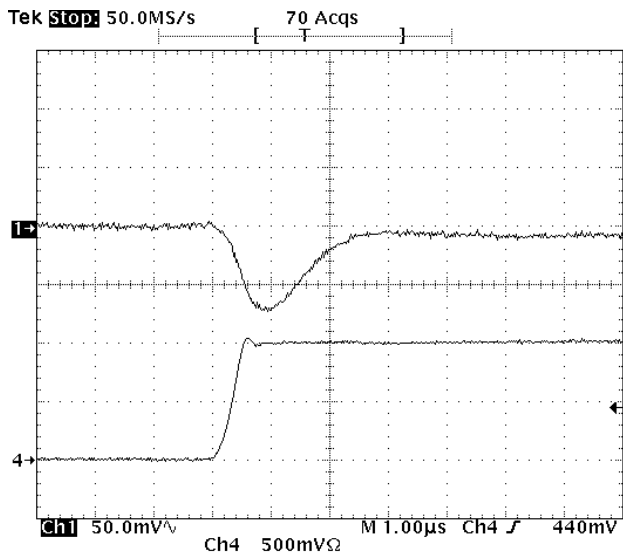

Figure 4 - Step-up transient load response from 2mA to 1A, $t_r < 1\mu\text{s}$.
 Ch1: Output voltage, AC, 50mV/div
 Ch4: Load Current, 0.5A/div

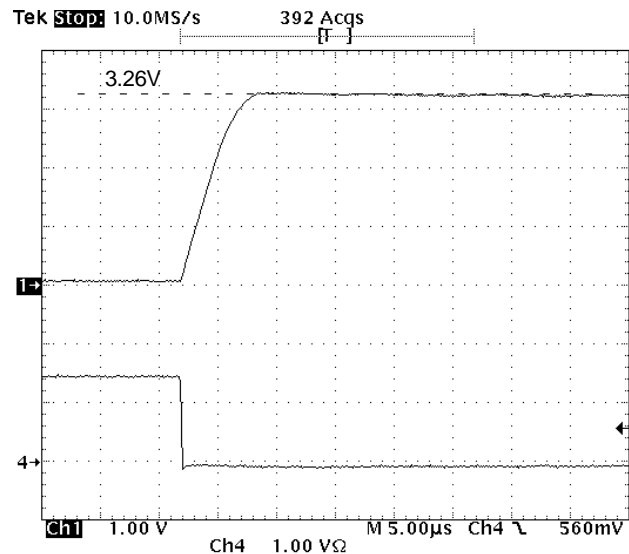

Figure 6 - Short circuit removal, I_{OUT} from short to 10mA.
 Ch1 Peak: 3.26V
 Ch1: Output voltage, 1V/div
 Ch4: Load Current, 1A/div

TYPICAL PERFORMANCE CHARACTERISTICS

Unless specified, the test data applies: $T_A=25^\circ\text{C}$, $C_{IN}=4.7\mu\text{F}$, $C_{OUT}=4.7\mu\text{F}$ ceramic and $V_{IN}=5\text{V}$.

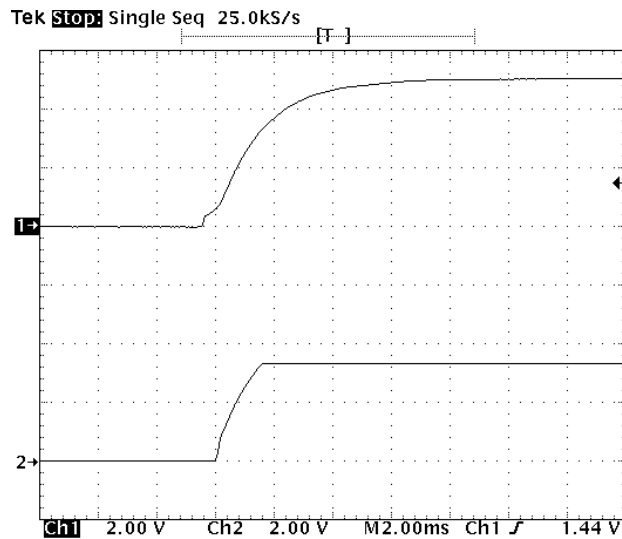

Figure 7 - Start-up at $I_{OUT}=10\text{mA}$.
 Ch1: 5V input voltage, 2V/div
 Ch2: 3.3V output voltage, 2V/div



Figure 9 - Input voltage transient response,
 V_{IN} from 0V to 5V, $C_{OUT}=10\mu\text{F}$.
 Ch2 Peak: 3.48V
 Ch1: 5V input voltage, 2V/div
 Ch2: 3.3V output voltage, 1V/div

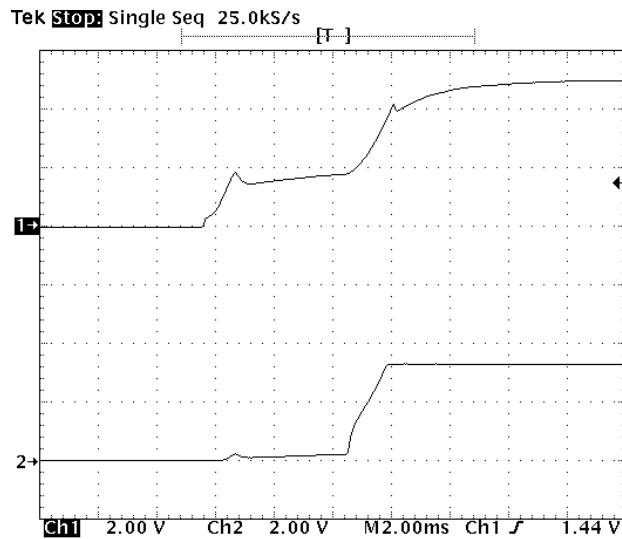

Figure 8 - Start-up at $I_{OUT}=1\text{A}$.
 Ch1: 5V input voltage, 2V/div
 Ch2: 3.3V output voltage, 2V/div

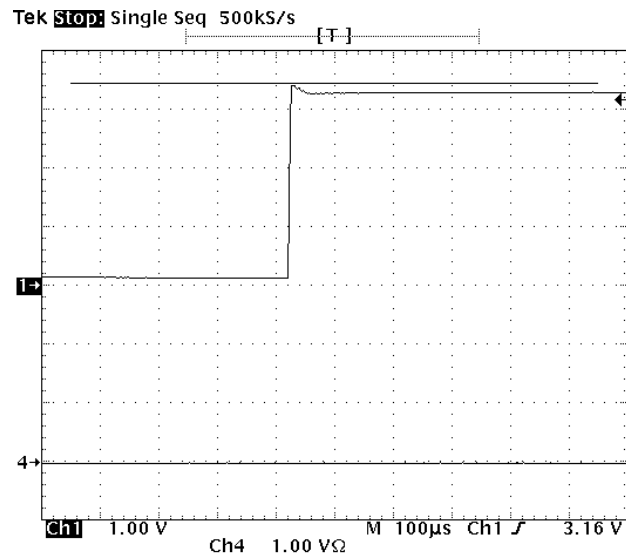

Figure 10 - Thermal shutdown removal response.
 $I_{LOAD} = 10\text{mA}$
 Ch1 Peak: 3.44V
 Ch1: Output voltage, 1V/div
 Ch4: Load Current, 1A/div

TYPICAL PERFORMANCE CHARACTERISTICS

Unless specified, the test data applies: $T_A=25^\circ\text{C}$, $C_{IN}=4.7\mu\text{F}$, $C_{OUT}=4.7\mu\text{F}$ ceramic and $V_{IN}=5\text{V}$.

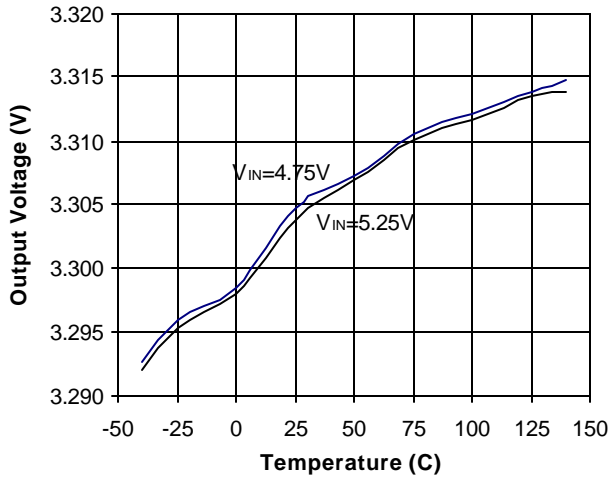

Figure 11 - Output Voltage vs. Temperature ($I_o=5\text{mA}$).

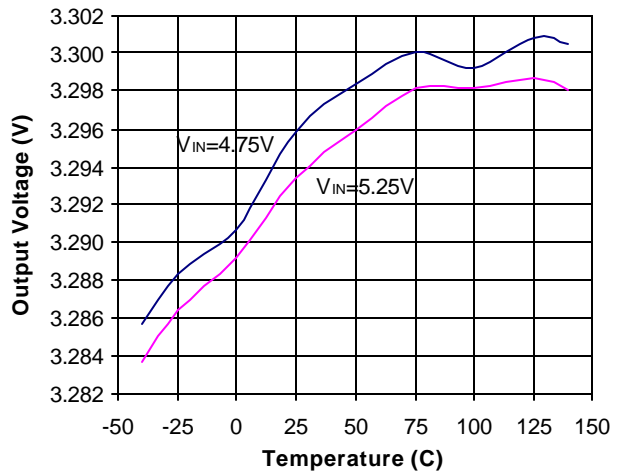

Figure 12 - Output Voltage vs. Temperature ($I_o=1\text{A}$).

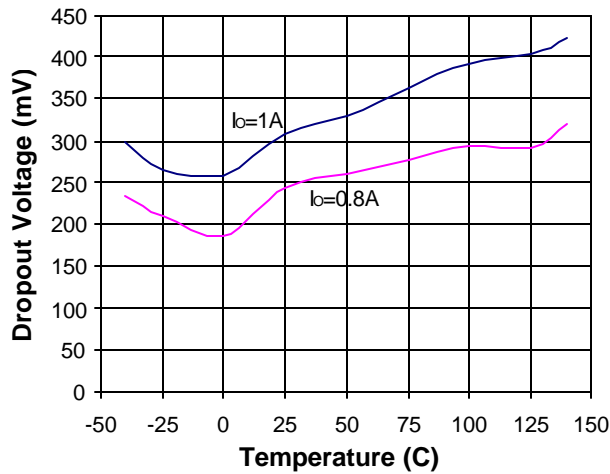

Figure 13 - Dropout Voltage vs. Temperature and Load Current.

TYPICAL PERFORMANCE CHARACTERISTICS

Unless specified, the test data applies: $T_A=25^\circ\text{C}$, $C_{IN}=4.7\mu\text{F}$, $C_{OUT}=4.7\mu\text{F}$ ceramic and $V_{IN}=5\text{V}$.

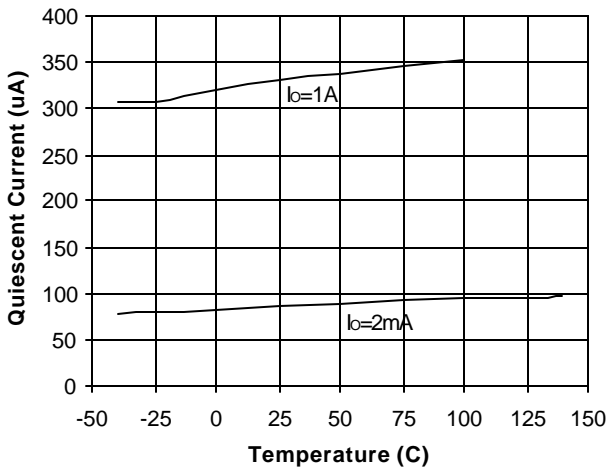

Figure 14 - Quiescent Current vs. Load Current and Temperature.

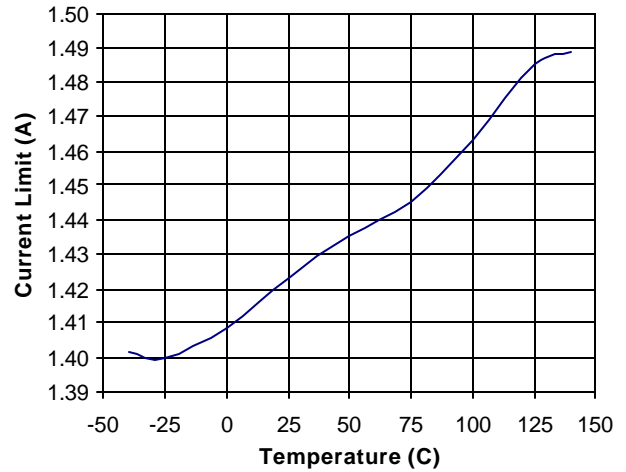

Figure 15 - Typical Current Limit vs. Temperature ($V_{IN}=5.5\text{V}$)

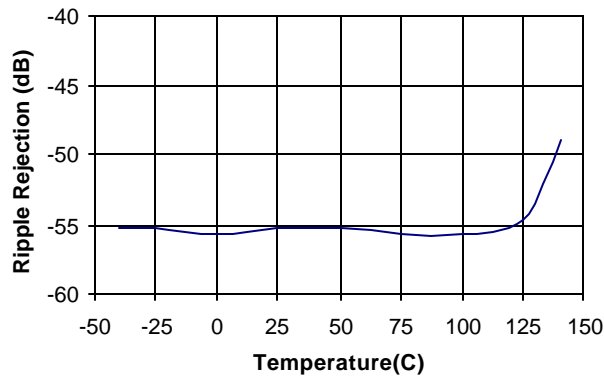

Figure 16 - 120Hz Ripple Rejection vs. Temperature.

APPLICATION INFORMATION

Introduction

The IRU1502-33 regulator is a 3-terminal device offered in a fixed output of 3.3V and it is designed specifically to provide an extremely low dropout voltage.

The IRU1502-33 is designed to meet the fast current transient needs as well as providing an accurate initial voltage, reducing the overall system cost with the need for fewer number of output capacitors.

Thermal Protection

When the junction temperature exceeds 135°C, the internal thermal protection shuts the IRU1502-33 down.

Current Limit Protection

The IRU1502-33 provides Over Current Protection when the output current exceeds typically 1.4A. The output decreases to limit the power dissipation.

Stability

The IRU1502-33 requires the use of an output capacitor as part of the frequency compensation in order to make the regulator stable. A minimum input capacitance of 4.7μF and a minimum output capacitance 4.7μF Ceramic capacitor is needed for regulator stage as well as the specified minimum loads to guarantee stability.

Transient Response and PSRR

The input and output capacitors are critical in order to ensure good transient response and PSRR. The most important aspects of this are capacitor selection, placement and trace routing. Place each capacitor as close as physically possible to its corresponding regulator pin. Use wide traces for a low inductance path. Couple directly to the ground and power planes as possible. The use of low ESR capacitors is crucial to achieving good results. Larger capacitance and lower ESR will improve both PSRR and transient response.

Thermal Design

The IRU1502-33 incorporates an internal thermal shut-down that protects the device when the junction temperature exceeds the allowable maximum junction temperature. Although this device can operate with junction temperatures in the range of 150°C, it is recommended that the selected heat sink be chosen such that during maximum continuous load operation the junction temperature is kept below 125°C. The following shows the typical thermal design.

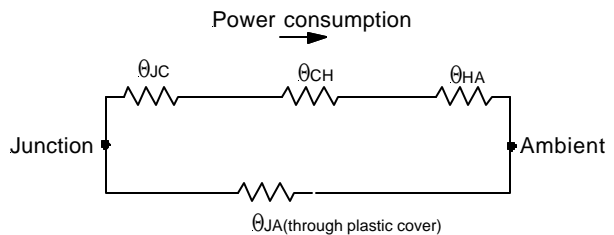

Figure 17 - Thermal resistor diagram for IRU1502-33.

Where:

θ_{JC} is the thermal resistance from junction to case.
 θ_{CH} is the thermal resistance from case to heat sink if applicable.

θ_{HA} is the thermal resistance from heat sink to ambient.

$\theta_{JA(\text{through plastic cover})}$ is the thermal resistance from junction to the ambient through plastic cover. Typically it is very large and can be neglected. Therefore, overall junction-to-ambient thermal resistance can be represented as:

$$\theta_{JA} \cong \theta_{JC} + \theta_{CH} + \theta_{HA}$$

Where θ_{JA} is the junction to ambient thermal resistance.

The thermal pad of MLPM is connected to a 1 inch square copper through vias for a four layer PCB board design. From the datasheet, this thermal junction-to-ambient resistance is given as:

$$\theta_{JA}=42^{\circ}\text{C/W}$$

Where:

$$\theta_{JC} \cong 2.3^{\circ}\text{C}$$

$$\theta_{CH} \cong 1^{\circ}\text{C}$$

$$\theta_{HA} \cong 38.7^{\circ}\text{C}$$

For IRU1502-33, the thermal design needs to be consider so that the resultant junction temperature is lower than the maximum operating temperature, which is 125°C. Therefore:

$$T_J = \theta_{JA} \times P_D + T_A \leq 125^{\circ}\text{C}$$

Assuming, the following conditions:

$$V_{OUT} = 3.3\text{V}$$

$$V_{IN} = 5\text{V}$$

$$I_{OUT} = 1\text{A (DC Avg)}$$

Calculate the maximum power dissipation using the following equation:

$$P_D = I_{OUT} \times (V_{IN} - V_{OUT})$$

$$P_D = 1 \times (5 - 3.3) = 1.7\text{W}$$

For MLPM package, we have:

$$\theta_{JA} = 42^{\circ}\text{C/W}$$

$$T_A = 45^{\circ}\text{C}$$

$$\Delta T = P_D \times \theta_{JA} = 1.7 \times 42 = 71.4$$

$$T_J = T_A + \Delta T = 116.4^{\circ}\text{C}$$

Layout Consideration

The IRU1502-33, like many other high-speed regulators, requires that the output capacitors be close to the device for stability. For power consideration, a ground plane pad of approximately one-inch square on the component side must be dedicated to the device where all ground pins are connected to dissipate the power. If a multilayer board is used, it is recommended that the inner layers of the board are also dedicated to the size of the pad for better thermal characteristics.

(H) MLPM Package
6-Pin

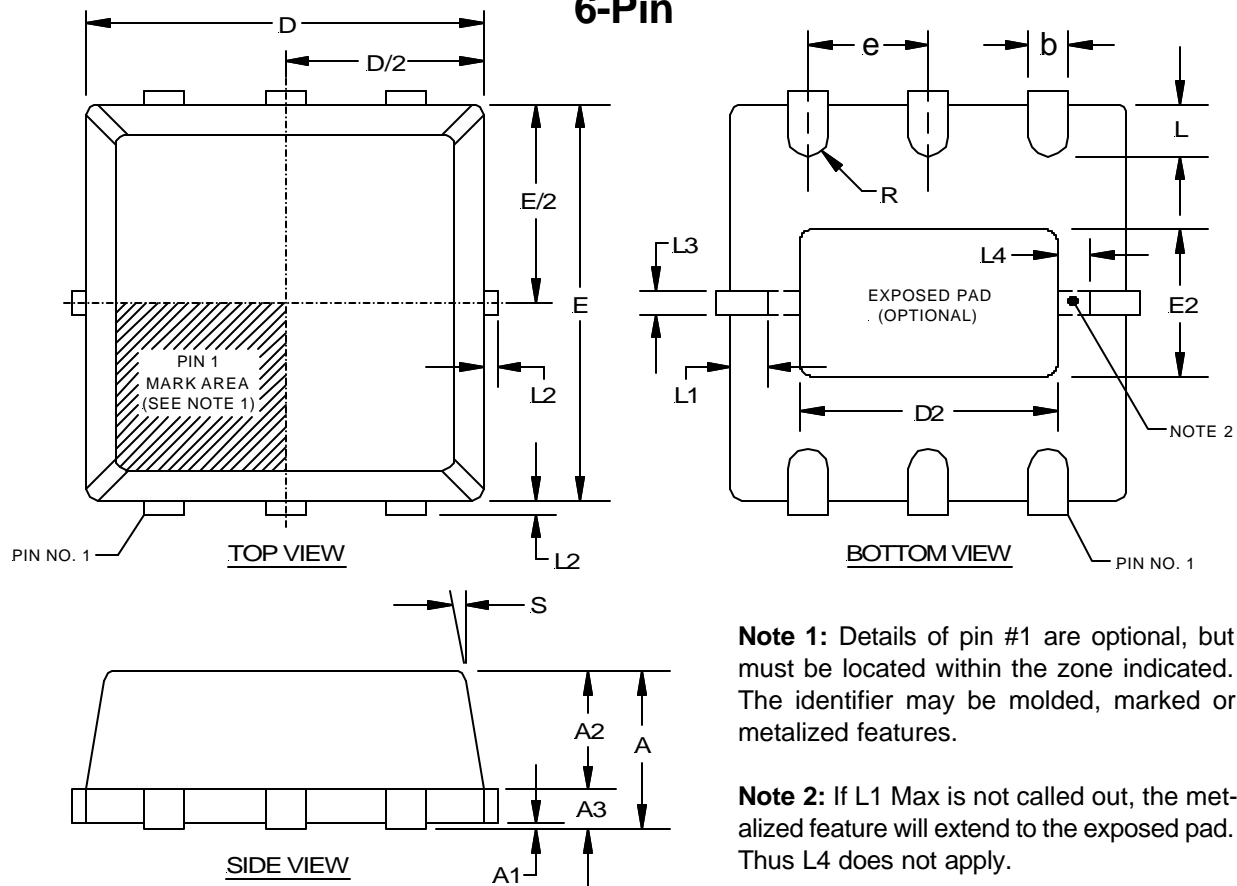

SYMBOL	6-PIN 3x3		
	MIN	NOM	MAX
A	0.80	0.90	1.00
A1	0.00	0.025	0.05
A2	0.65	0.70	0.75
A3	0.15	0.20	0.25
b	0.33	0.35	0.43
D	3.00 BSC		
D2	1.92	2.02	2.12
E	3.00 BSC		
E2	1.11	1.21	1.31
e	0.95		
L	0.20	0.29	0.45
L1	0.16	0.24	0.40
L2	---	---	0.125
L3	0.17	---	0.30
L4	0.17	---	---
R	0.127 REF		
S	0°	10°	12°

NOTE: ALL MEASUREMENTS ARE IN MILLIMETERS.

PACKAGE SHIPMENT METHOD

PKG DESIG	PACKAGE DESCRIPTION	PIN COUNT	PARTS PER TUBE	PARTS PER REEL	T & R Orientation
H	MLPM 3x3	6	---	3000	Fig A

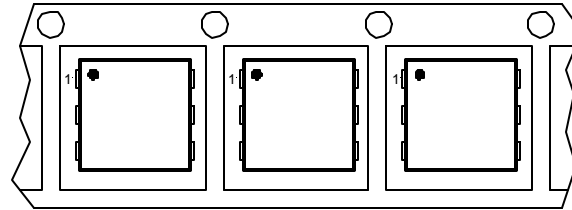

→
 Feed Direction
 Figure A - Live Bug