

ICL8021/ICL8023

High Reliability Low Power Bipolar Operational Amplifier

GENERAL DESCRIPTION

The Intersil ICL8021 series are low power operational amplifiers specifically designed for applications requiring very low standby power consumption over a wide range of supply voltages. The electrical characteristics of the 8021 series can be tailored to a particular application by adjusting an external resistor, R_{SET} , which controls the quiescent current. This is advantageous because I_Q can be made independent of the supply voltages: it can be set to an extremely low value where power is critical, or to a larger value for high slew rate or wideband applications.

Other features of the 8021 series include low input current that remains constant with temperature, low noise, high input impedance, internal compensation and pin-for-pin compatibility with the 741.

The Intersil 8023 consists of three low power operational amplifiers in a single 16-pin DIP. Each amplifier is identical to an 8021 low power op amp, and has separate connections for adjusting its electrical characteristics by means of an external resistor, R_{SET} , which controls the quiescent current of that amplifier.

ORDERING INFORMATION

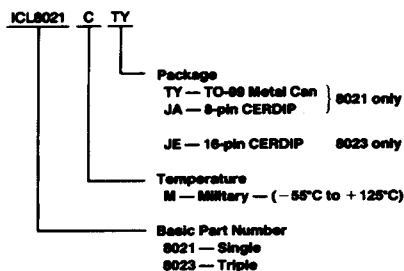

0144-1

FEATURES

- $V_{OS} = 3mV$ Max (Adjustable to Zero)
- $\pm 1.5V$ to $\pm 18V$ Power Supply Operation
- Power Consumption — $20\mu W$ @ $\pm 1V$
- Input Bias Current — $30nA$ Max
- Internal Compensation
- Pin-For-Pin Compatible With 741
- Short Circuit Protected

Part Number	Temperature Range	Package
ICL8021MTY*	-55°C to +125°C	8 Lead Metal Can
ICL8023MJE*	-55°C to +125°C	16 Lead CERDIP

*Add /88313 to Part Number if 883B processing is required.

ICL8021/ICL8023

ABSOLUTE MAXIMUM RATINGS

Supply Voltage	$\pm 18V$
Differential Input Voltage (Note 1)	$\pm 15V$
Common Mode Input Voltage (Note 1)	$\pm 15V$
Output Short Circuit Duration	Indefinite
Power Dissipation (Note 2)	300mW

Operating Temperature Range	8021M/8023M	$-55^{\circ}C$ to $+125^{\circ}C$
Storage Temperature Range		$-65^{\circ}C$ to $+150^{\circ}C$
Lead Temperature (Soldering, 10sec)		$+300^{\circ}C$

NOTE 1: For supply voltages less than $\pm 15V$, the absolute maximum input voltage is equal to the supply voltage.

NOTE 2: Rating applies for case temperatures to $+125^{\circ}C$; derate linearly at $5.6 \text{ mW}/^{\circ}C$ for ambient temperatures above $+95^{\circ}C$.

NOTE: Stresses above those listed under "Absolute Maximum Ratings" may cause permanent damage to the device. These are stress ratings only and functional operation of the device at these or any other conditions above those indicated in the operational sections of the specifications is not implied. Exposure to absolute maximum rating conditions for extended periods may affect device reliability.

2

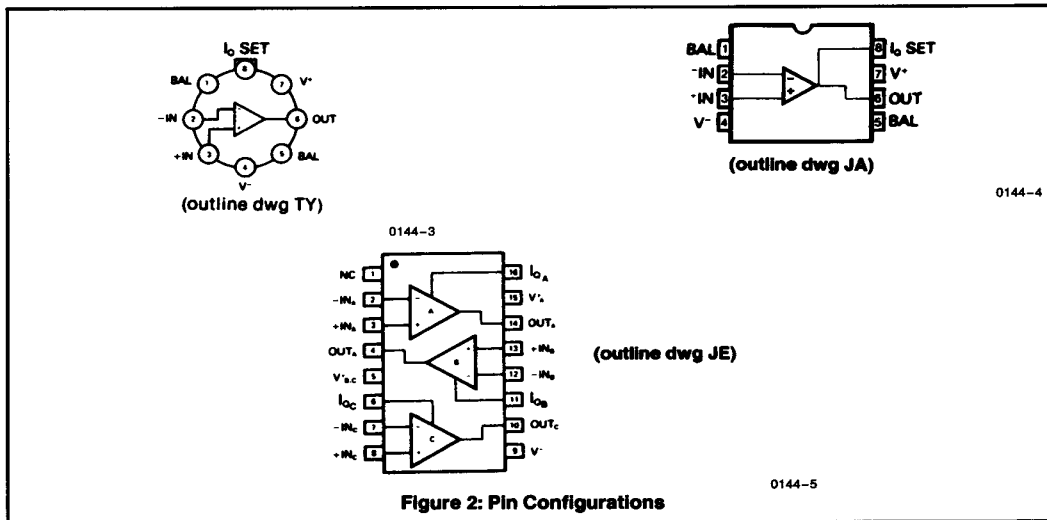
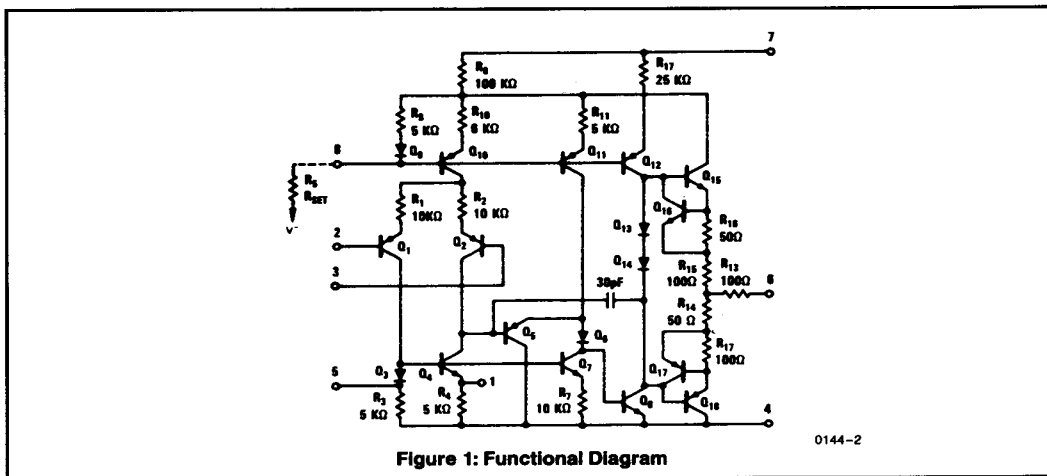

ICL8021/ICL8023

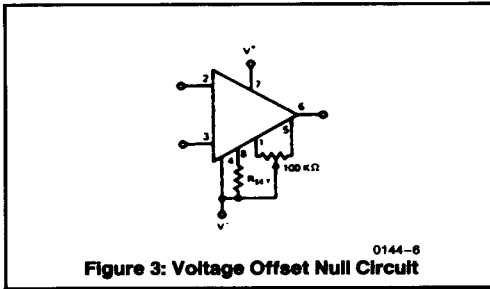

ELECTRICAL CHARACTERISTICS ($V_{SUPPLY} = \pm 6V$, $I_Q = 30\mu A$, unless otherwise specified.)

Characteristics	Test Conditions	8021M			Units
		Min	Typ	Max	
The following specifications apply for $T_A = 25^\circ C$:					
Input Offset Voltage	$R_S \leq 100k\Omega$		2	3	mV
Input Offset Current			0.5	7.5	nA
Input Bias Current			5	20	nA
Input Resistance		3	10		M Ω
Input Voltage Range	$V_{SUPPLY} = \pm 15V$	± 12	± 13		V
Common Mode Rejection Ratio	$R_S \leq 10k\Omega$	70	80		dB
Supply Voltage Rejection Ratio	$R_S \leq 10k\Omega$		30	150	$\mu V/V$
Output Resistance	Open Loop		2		k Ω
Output Voltage Swing	$R_L \geq 20k\Omega$, $V_{SUPPLY} = \pm 15V$	± 12	± 14		V
	$R_L \geq 10k\Omega$, $V_{SUPPLY} = \pm 15V$	± 11	± 13		V
Output Short-Circuit Current			± 13		mA
Power Consumption	$V_{OUT} = 0$		360	480	μW
Slew Rate (Unity Gain)			0.16		V/ μs
Unity Gain Bandwidth	$R_L = 20k\Omega$, $V_{IN} = 20mV$		270		kHz
Transient Response (Unity Gain) Risetime Overshoot	$R_L = 20k\Omega$, $V_{IN} = 20mV$		1.3		μs
			10		%
Specifications Applicable over Temperature		$-55^\circ C \leq T_A \leq +125^\circ C$			
Input Offset Voltage	$R_S \leq 10k\Omega$		2.0	5.0	mV
Input Offset Current			1.0	11	nA
Input Bias Current			10	32	nA
Average Temperature Coefficient of Input Offset Voltage	$R_S \leq 10k\Omega$		5		$\mu V/^\circ C$
Average Temperature Coefficient of Input Offset Current			1.7		pA/ $^\circ C$
Large Signal Voltage Gain	$R_L = 10k\Omega$	50	200		V/mV
Output Voltage Swing	$R_L \geq 10k\Omega$	± 10	± 13		V

ICL8021/ICL8023

QUIESCENT CURRENT ADJUSTMENT
 QUIESCENT CURRENT SETTING RESISTOR
 (PIN 8 to V⁻)

V _S	I _Q			
	10μA	30μA	100μA	300μA
±1.5	1.5MΩ	470kΩ	150kΩ	-
±3	3.3MΩ	1.1MΩ	330kΩ	100kΩ
±6	7.5MΩ	2.7MΩ	750kΩ	220kΩ
±9	13MΩ	4MΩ	1.3MΩ	350kΩ
±12	18MΩ	5.6MΩ	1.5MΩ	510kΩ
±15	22MΩ	7.5MΩ	2.2MΩ	620kΩ

QUIESCENT CURRENT SETTING RESISTOR
 (PIN 8 to V⁻)

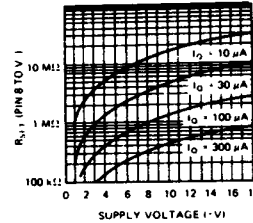

0144-7

2

TYPICAL PERFORMANCE CHARACTERISTICS*

(T_A = +25°C, V_S = ±6V, I_Q = 30μA unless otherwise specified.)

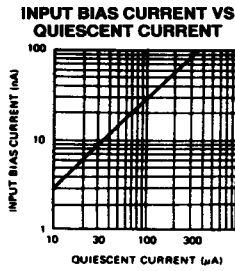

0144-8

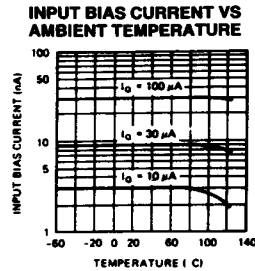

0144-9

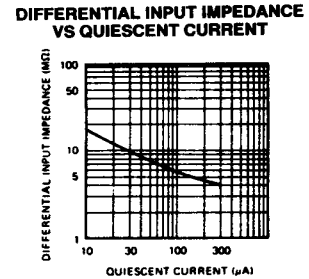

0144-10

ICL8021/ICL8023

TYPICAL PERFORMANCE CHARACTERISTICS*

($T_A = +25^\circ\text{C}$, $V_S = \pm 6\text{V}$, $I_Q = 30\mu\text{A}$ unless otherwise specified.) (Continued)

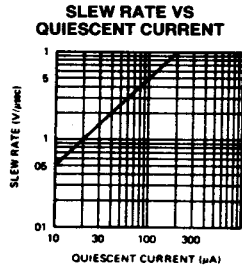

0144-11

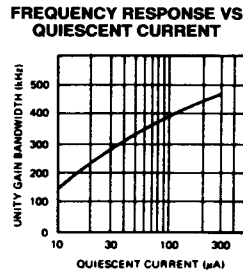

0144-12

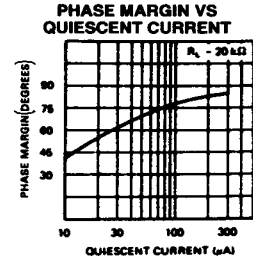

0144-13

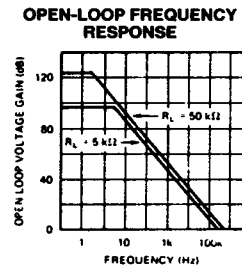

0144-14

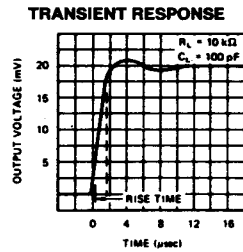

0144-15

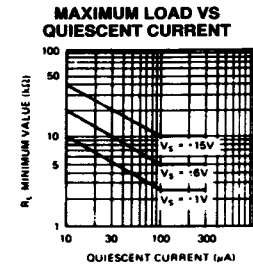

0144-16

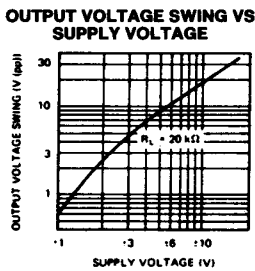

0144-17

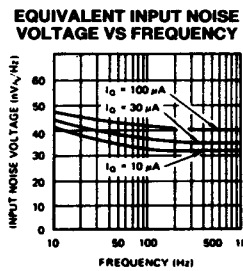

0144-18

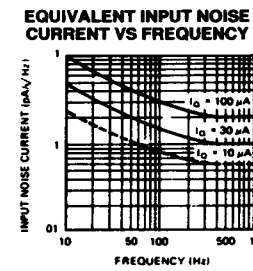

0144-19

*ICL8021C guaranteed only for $0^\circ\text{C} \leq T_A \leq +70^\circ\text{C}$