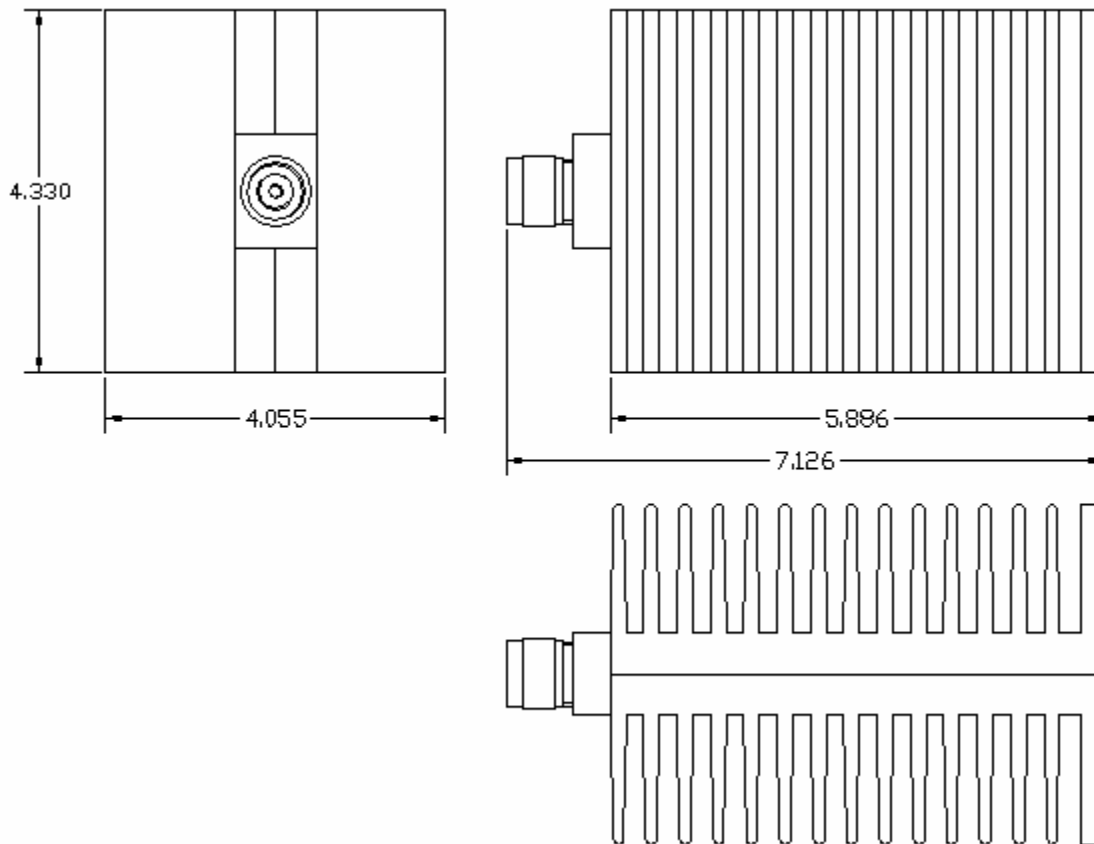

Electrical Specifications:

- Frequency Range: DC~4.0GHz
- VSWR: 1.15:1 below 2GHz, 1.25:1 to 4GHz
- Average Power: 100 Watts
- Peak Power: 5 kWatts, 5 μ S duration
- Connector: 50 ohm N-type Female or male
- Size: 5.886 \times 4.055 \times 4.330 inch
- Weight: ~4.0lb (1.8kg)
- Cooling: Air

**Mechanical Structure:**

Note: All units in inches.