



VRE205

Precision Surface Mount Reference Supply



THALER CORPORATION • 2015 N. FORBES BOULEVARD • TUCSON, AZ. 85745 • (520) 882-4000

FEATURES

- PIN AND FUNCTION COMPATIBLE TO REF02
- VERY HIGH ACCURACY: 5.000 V OUTPUT ± 0.4 mV
- EXTREMELY LOW DRIFT: 0.6 ppm/ $^{\circ}$ C -55 $^{\circ}$ C to +125 $^{\circ}$ C
- EXCELLENT STABILITY: 6 ppm/1000 Hrs. Typ.
- EXCELLENT LINE REGULATION: 6 ppm/V Typ.
- WIDE SUPPLY RANGE: +13.5 V to -22.0 V
- HERMETIC 20 TERMINAL CERAMIC LCC
- MILITARY PROCESSING OPTION

DESCRIPTION

VRE205 Series Precision Voltage References provides ultrastable +5.000 V outputs with ± 0.4 mV initial accuracy and temperature coefficient as low as 0.6 ppm/ $^{\circ}$ C over the full military temperature range. This improvement in accuracy is made possible by a unique, proprietary multipoint laser compensation technique developed by Thaler Corporation. Significant improvements have been made in other performance parameters as well, including initial accuracy, warm-up drift, line regulation, and long-term stability, making the VRE205 series the most accurate and stable 5V references available.

VRE205 series devices are available in two operating temperature ranges, -25 $^{\circ}$ C to +85 $^{\circ}$ C and -55 $^{\circ}$ C to +125 $^{\circ}$ C, and two performance grades. All devices are packaged in 20 terminal ceramic LCC packages for maximum long-term stability. "M" versions are screened for high reliability and quality.

APPLICATIONS

- PRECISION A/D and D/A CONVERTERS
- TRANSDUCER EXCITATION
- ACCURATE COMPARATOR THRESHOLD REFERENCE
- HIGH RESOLUTION SERVO SYSTEMS
- DIGITAL VOLTMETERS
- HIGH PRECISION TEST and MEASUREMENT INSTRUMENTS

SELECTION GUIDE

Type	Output	Temperature Operating Range	Max. Volt Deviation
VRE205C	+5V	-25 $^{\circ}$ C to +85 $^{\circ}$ C	0.4mV
VRE205CA	+5V	-25 $^{\circ}$ C to +85 $^{\circ}$ C	0.2mV
VRE205M	+5V	-55 $^{\circ}$ C to +125 $^{\circ}$ C	0.6mV
VRE205MA	+5V	-55 $^{\circ}$ C to +125 $^{\circ}$ C	0.3mV

ELECTRICAL SPECIFICATIONS

VRE205

Vps = ±15V, T = 25°C, RL = 10kΩ unless otherwise noted.

MODEL	C			CA			M			MA			
PARAMETERS	MIN	TYP	MAX	MIN	TYP	MAX	MIN	TYP	MAX	MIN	TYP	MAX	UNITS
ABSOLUTE MAXIMUM RATINGS													
Power Supply	+13.5		+22	*		*	*		*	*		*	V
Operating Temperature	-25		85	*		*	-55		125	-55		125	°C
Storage Temperature	-65		150	*		*	*		*	*		*	°C
Short Circuit Protection	Continuous				*			*			*		
OUTPUT VOLTAGE													
VRE205		+5			*			*			*		V
OUTPUT VOLTAGE ERRORS													
Initial Error			800			400			800			400	μV
Warmup Drift		2			1			2			1		ppm
T _{min} - T _{max} ⁽¹⁾			400			200			600			300	μV
Long-Term Stability		6			*			*			*		ppm/1000hrs
Noise (.1-10Hz)		3			*			*			*		μVpp
OUTPUT CURRENT													
Range	±10			*			*			*			mA
REGULATION													
Line		6	10		*	*		*	*		*	*	ppm/V
Load		3			*			*			*		ppm/mA
OUTPUT ADJUSTMENT													
Range		10			*			*			*		mV
Temperature Coeff.		4			*			*			*		μV/°C/mV
POWER SUPPLY CURRENTS ⁽²⁾													
VRE205 +PS		5	7		*	*		*	*		*	*	mA

NOTES: *Same as C Models.

1. Using the box method, the specified value is the maximum deviation from the output voltage at 25°C over the specified operating temperature range.

2. The specified values are unloaded.

TYPICAL PERFORMANCE CURVES

V_{OUT} vs. TEMPERATURE

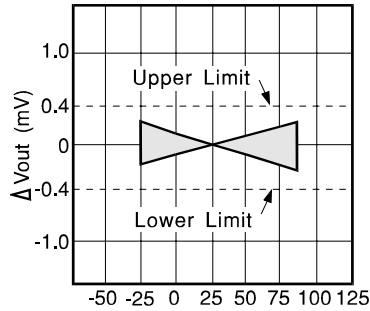

**Temperature °C
VRE205C**

V_{OUT} vs. TEMPERATURE

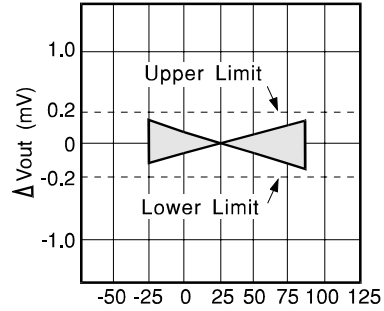

**Temperature °C
VRE205CA**

V_{OUT} vs. TEMPERATURE

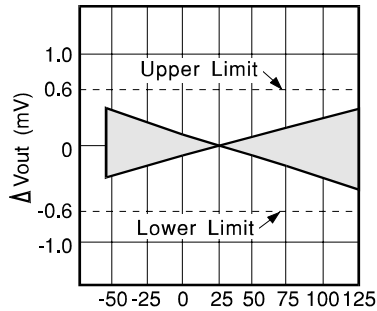

**Temperature °C
VRE205M**

V_{OUT} vs. TEMPERATURE

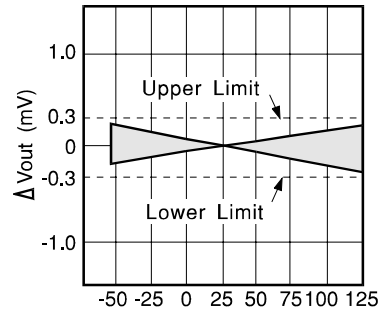

**Temperature °C
VRE205MA**

QUIESCENT CURRENT VS. TEMP

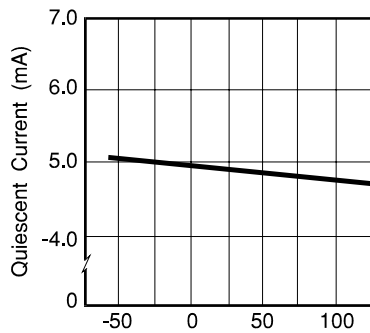

Temperature °C

JUNCTION TEMP. RISE VS. OUTPUT CURRENT

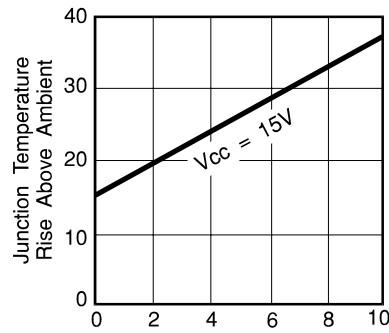

Output Current (mA)

PSRR vs. FREQUENCY

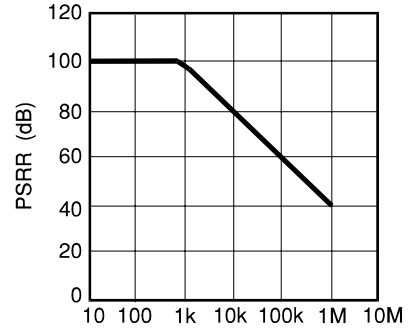

Frequency (Hz)

DISCUSSION OF PERFORMANCE

THEORY OF OPERATION

The following discussion refers to the schematic below. A FET current source is used to bias a 6.3 zener diode. The zener voltage is divided by the resistor network R1 and R2. This voltage is then applied to the noninverting input of the operational amplifier which amplifies the voltage to produce a 5.000V output. The gain is determined by the resistor networks R3 and R4: $G=1 + R4/R3$. The 6.3 zener diode is used because it is the most stable diode over time and temperature.

The current source provides a closely regulated zener current, which determines the slope of the references' voltage vs. temperature function. By trimming the zener current a lower drift over temperature can be achieved. But since the voltage vs. temperature function is nonlinear this compensation technique is not well suited for wide temperature ranges.

Thaler Corporation has developed a nonlinear compensation network of thermistors and resistors that is used in the VRE series voltage references. This proprietary network eliminates most of the nonlinearity in the voltage vs. temperature function. By then adjusting the slope, Thaler Corporation produces a very stable voltage over wide temperature ranges. This network is less than 2% of the overall network resistance so it has a negligible effect on long term stability. By using highly stable resistors in our network, we produce a voltage reference that also has very good long term stability.

APPLICATION INFORMATION

Figure 2 shows the proper connection of the VRE205 series voltage references with the optional trim resistors. Pay careful attention to the circuit layout to avoid noise pickup and voltage drops in the lines.

The VRE205 series voltage references have the ground terminal brought out on two pins (pin 9 and pin 10) which are connected together internally. This allows the user to achieve greater accuracy when using a socket. Voltage references have a voltage drop across their power supply ground pin due to quiescent current flowing through the contact resistance. If the contact resistance was constant with time and temperature, this voltage drop could be trimmed out. When the reference is plugged into a socket, this source of error can be as high as 20ppm. By connecting pin 10 to the power supply ground and pin 9 to a high impedance ground point in the measurement circuit, the error due to the contact resistance can be eliminated. If the unit is soldered into place, the contact resistance is sufficiently small that it does not effect performance.

VRE205

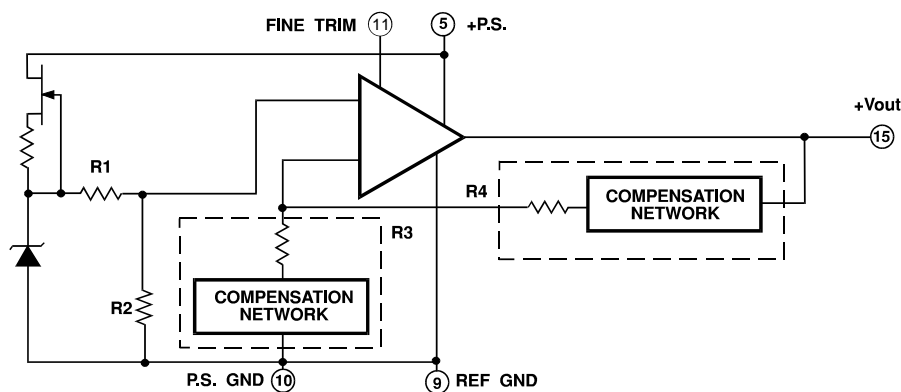

FIGURE 1

EXTERNAL CONNECTIONS

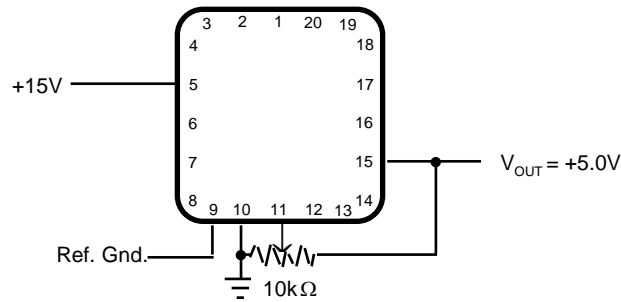
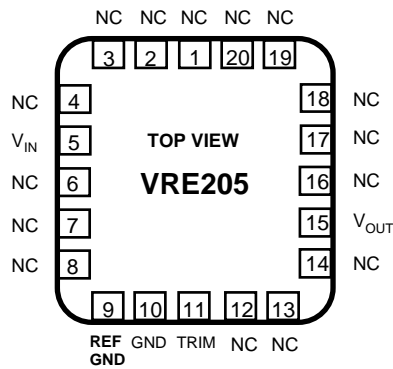
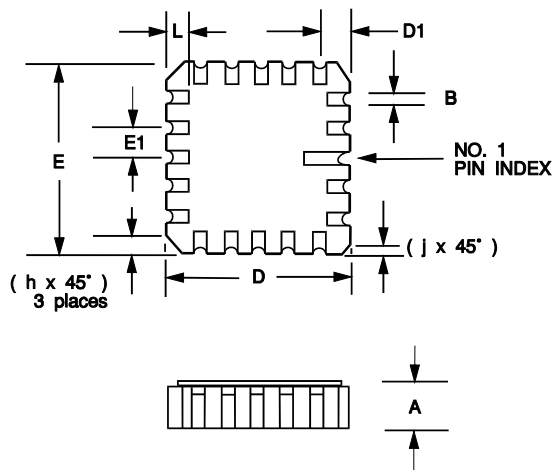

FIGURE 2

PIN CONFIGURATION



MECHANICAL



DIM	INCHES		MILLIMETER	
	MIN	MAX	MIN	MAX
A	0.090	0.110	2.29	2.79
B	0.022	0.028	0.56	0.71
D	0.342	0.358	8.68	9.09
D1	0.065	0.085	1.65	2.16
E	0.342	0.358	8.68	9.09
E1	0.045	0.055	1.14	1.40
j	0.010 REF		.254 REF	
h	0.040 REF		1.02 REF	
L	0.045	0.055	1.14	1.40