



# Digital Output Temperature Sensor

## FEATURES

- -20°C to +125°C Operating Temperature Range
- Supply Range: 3.0V to 3.6V
- I<sup>2</sup>C /SMBus Interface
- JEDEC compliant for DDR3 DIMM applications
- Schmitt Triggers and Noise Suppression Filters on SCL and SDA Inputs
- Low Power CMOS Technology
- RoHS-compliant 2 x 3 x 0.75mm TDFN and 2 x 3 x 0.5mm UDFN packages

For Ordering Information details, see page 19.

## PIN CONFIGURATION

	<b>TDFN (VP2)</b>		
	<b>UDFN (HU3)</b>		
A <sub>0</sub>	1	8	V <sub>CC</sub>
A <sub>1</sub>	2	7	EVENT
A <sub>2</sub>	3	6	SCL
V <sub>SS</sub>	4	5	SDA

**Note:** For the location of Pin 1, please consult the corresponding package drawing.

## PIN FUNCTIONS

Name	Description
A <sub>0</sub> , A <sub>1</sub> , A <sub>2</sub>	Device Address Input
SDA	Serial Data Input/Output
SCL	Serial Clock Input
EVENT	Open-drain Event Output
V <sub>CC</sub>	Power Supply
V <sub>SS</sub>	Ground

## DESCRIPTION

The CAT6095 is a 12-bit (plus Sign bit) Digital Output Temperature Sensor designed for general purpose temperature measurements requiring a digital output.

CAT6095 measures temperature approximately 10 times every second and compares each reading to 3 user programmed temperature limits after each new reading. Temperature readings can be retrieved by the host via the I<sup>2</sup>C/SMBus interface. Temperature readings over and under limit conditions are signaled on the open-drain EVENT pin. The hysteresis for these temperature limits is user programmable and the EVENT pin response can be programmed to operate either as a comparator or in an interrupt mode.

CAT6095 is packaged in space saving TDFN or UDFN packages. These packages offer the added advantage of rapid response to thermal changes by transmitting external environmental conditions directly to the sensing element, making CAT6095 much faster than sensors packaged in conventional SOIC and SOT packages.

## FUNCTIONAL SYMBOL

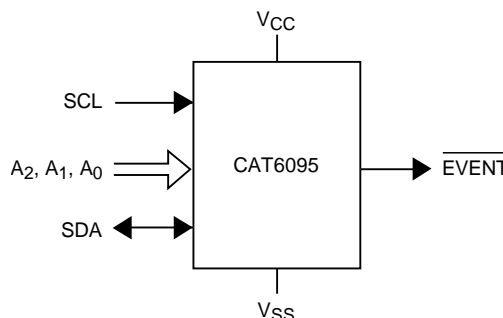

**ABSOLUTE MAXIMUM RATINGS<sup>(1)</sup>**

Operating Temperature	-45°C to +130°C
Storage Temperature	-65°C to +150°C
Voltage on any pin with respect to Ground <sup>(2)</sup>	-0.5V to +6.5V

**TEMPERATURE CHARACTERISTICS**

T<sub>A</sub> = -20°C to +125°C, V<sub>CC</sub> = 3.0 V to 3.6 V, unless otherwise specified

Parameter	Test Conditions/Comments	Max	Unit
Temperature Reading Error Class B, JC42.4 compliant	75°C ≤ T <sub>A</sub> ≤ 95°C, active range	+/- 1.0	°C
	40°C ≤ T <sub>A</sub> ≤ 125°C, monitor range	+/- 2.0	°C
	-20°C ≤ T <sub>A</sub> ≤ 125°C, sensing range	+/- 3.0	°C
ADC Resolution		12	Bits
Temperature Resolution		0.0625	°C
Temperature Conversion Time		100	ms
Thermal Resistance <sup>(3)</sup> θ <sub>JA</sub>	Junction-to-Ambient (Still Air)	92	°C/W

**D.C. OPERATING CHARACTERISTICS**

T<sub>A</sub> = -20°C to +125°C, V<sub>CC</sub> = 3.0V to 3.6V

Symbol	Parameter	Test Conditions/Comments	Min	Max	Unit
I <sub>CC</sub>	Quiescent Current			200	µA
I <sub>SHDN</sub>	Shutdown Current	Thermal Sensor shutdown		5	µA
I <sub>L</sub>	I/O Pin Leakage Current	Pin at GND or V <sub>CC</sub>		5	µA
V <sub>IL</sub>	Input Low Voltage		-0.5	0.2 x V <sub>CC</sub>	V
V <sub>IH</sub>	Input High Voltage		0.8 x V <sub>CC</sub>	V <sub>CC</sub> + 0.5	V
V <sub>OL</sub>	Output Low Voltage	I <sub>OL</sub> = 3mA, V <sub>CC</sub> > 2.5V		0.4	V

**Notes:**

- (1) Stresses above those listed under “Absolute Maximum Ratings” may cause permanent damage to the device. These are stress ratings only, and functional operation of the device at these or any other conditions outside of those listed in the operational sections of this specification is not implied. Exposure to any absolute maximum rating for extended periods may affect device performance and reliability.
- (2) The DC input voltage on any pin should not be lower than -0.5V or higher than V<sub>CC</sub> + 0.5V. During transitions, the voltage on any pin may undershoot to no less than -1.5V or overshoot to no more than V<sub>CC</sub> + 1.5V, for periods of less than 20 ns.
- (3) Power Dissipation is defined as P<sub>J</sub> = (T<sub>J</sub> - T<sub>A</sub>)/θ<sub>JA</sub>, where T<sub>J</sub> is the junction temperature and T<sub>A</sub> is the ambient temperature. The thermal resistance value refers to the case of a package being used on a standard 2-layer PCB.

**A.C. CHARACTERISTICS<sup>(1)</sup>**

$T_A = -20^{\circ}\text{C}$  to  $+125^{\circ}\text{C}$ ,  $V_{CC} = 3.0\text{V}$  to  $3.6\text{V}$

Symbol	Parameter	Min	Max	Units
$F_{SCL}$	Clock Frequency	$10^{(2)}$	400	kHz
$t_{HD:STA}$	START Condition Hold Time	0.6		$\mu\text{s}$
$t_{LOW}$	Low Period of SCL Clock	1.3		$\mu\text{s}$
$t_{HIGH}$	High Period of SCL Clock	0.6		$\mu\text{s}$
$t_{SU:STA}$	START Condition Setup Time	0.6		$\mu\text{s}$
$t_{HD:DAT}$	Data Hold Time	0		ns
$t_{SU:DAT}$	Data Setup Time	100		ns
$t_R$	SDA and SCL Rise Time		300	ns
$t_F^{(1)}$	SDA and SCL Fall Time		300	ns
$t_{SU:STO}$	STOP Condition Setup Time	0.6		$\mu\text{s}$
$t_{BUF}$	Bus Free Time Between STOP and START	1.3		$\mu\text{s}$
$t_{AA}$	SCL Low to SDA Data Out		0.9	$\mu\text{s}$
$t_{DH}$	Data Out Hold Time	100		ns
$T_i^{(1)}$	Noise Pulse Filtered at SCL and SDA Inputs		50	ns
$t_{PU}^{(4)}$	Power-up to Ready Mode		100	ms
$t_{D:SMB}^{(2)}$	SMBus Time-Out (Maximum SCL LOW Time)		10	ms

**A.C. TEST CONDITIONS**

Input Drive Levels	$0.2V_{CC}$ to $0.8V_{CC}$
Input Rise and Fall Time	< 50ns
Input Reference Levels	$0.25V_{CC}$ , $0.75V_{CC}$
Output Reference Level	$0.5V_{CC}$
Output Test Load	$I_{OL} = 3\text{mA}$ ( $V_{CC} > 2.5\text{V}$ ); $I_{OL} = 1\text{mA}$ ( $V_{CC} < 2.5\text{V}$ ); $C_L = 100\text{pF}$

**PIN IMPEDANCE CHARACTERISTICS**

$T_A = 25^{\circ}\text{C}$ ,  $V_{CC} = 3.0\text{V}$  to  $3.6\text{V}$ ,  $f = 100\text{kHz}$ , unless otherwise specified

Symbol	Parameter	Test Conditions/Comments	Min	Max	Unit
$C_{IN}^{(3)}$	SDA, EVENT Pin Capacitance	$V_{IN} = 0$		8	pF
$C_{IN}^{(3)}$	Input Capacitance (other pins)	$V_{IN} = 0$		6	pF

**Notes:**

- (1) Test Conditions according to A.C. TEST CONDITIONS Table.
- (2) The TS interface will release the bus after the SMBus time-out of 10ms.
- (3) These parameters are tested initially and after a design or process change that affects the parameter.
- (4) A valid temperature reading can not be expected sooner than approx. 100ms after  $V_{CC}$  reaches the nominal value of 3.0V.

FUNCTIONAL DIAGRAM

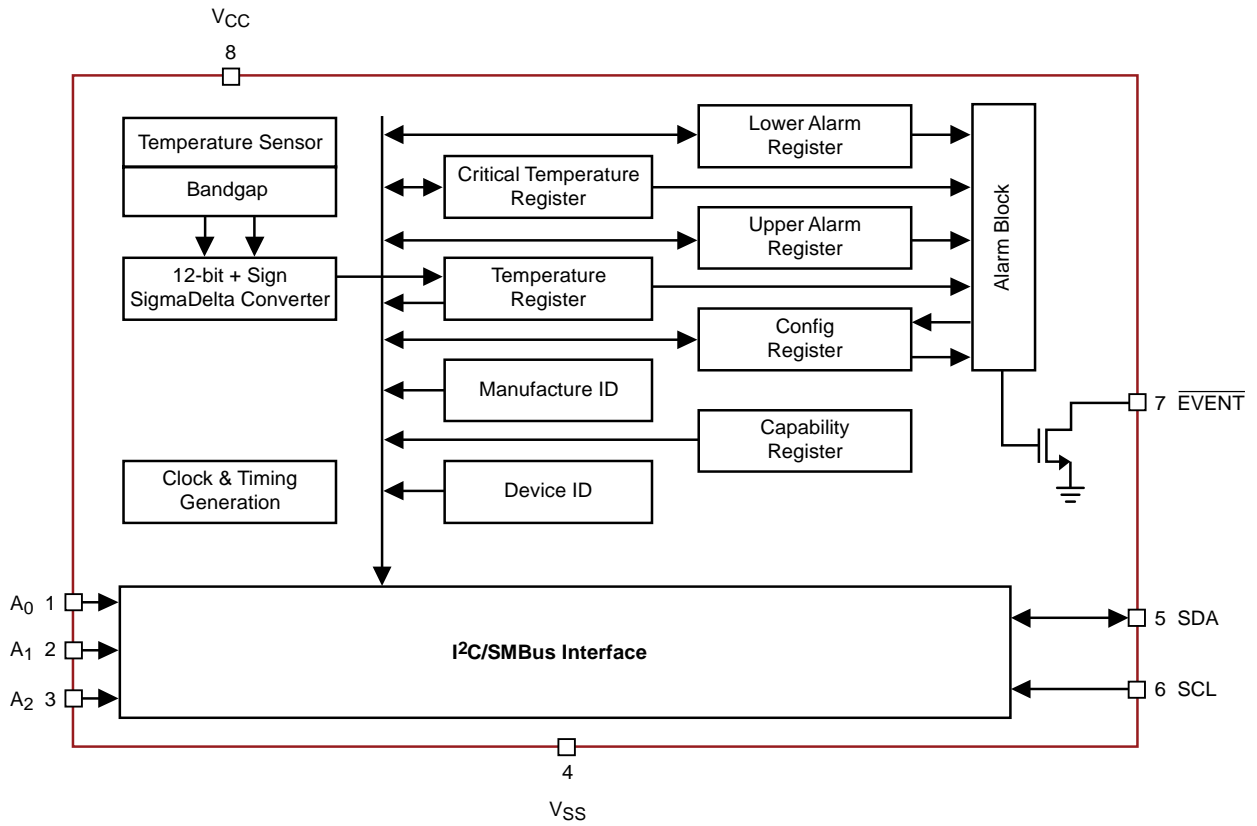

## PIN DESCRIPTION

**SCL:** The Serial Clock input pin accepts the Serial Clock generated by the Master (Host).

**SDA:** The Serial Data I/O pin receives input data and transmits data stored in the internal registers. In transmit mode, this pin is open drain. Data is acquired on the positive edge, and is delivered on the negative edge of SCL.

**A0, A1 and A2:** The Address pins set the device address. These pins have on-chip pull-down resistors and will default to an address of 000 if left unconnected.

**EVENT:** The open-drain EVENT pin can be programmed to signal over/under temperature limit conditions.

## POWER-ON RESET (POR)

The CAT6095 incorporates Power-On Reset (POR) circuitry which monitors the supply voltage, and then resets (initializes) the internal state machine below (above) a POR trigger level of approximately 1.2 V, i.e. well below the minimum recommended  $V_{CC}$  value.

The TS powers-up into conversion mode. The internal state machine will operate properly above the POR trigger level, but valid temperature readings can be expected only after the first conversion cycle.

## DEVICE INTERFACE

The CAT6095 supports I<sup>2</sup>C and SMBus data transmission protocols. These protocols describe serial communication between transmitters and receivers sharing a 2-wire data bus. Data flow is controlled by a Master device, which generates the serial clock and the START and STOP conditions. The CAT6095 acts as a Slave device. Master and Slave alternate as transmitter and receiver. Up to 8 CAT6095 devices may be present on the bus simultaneously, and can be individually addressed by matching the logic state of the address inputs A0, A1, and A2.

## **I<sup>2</sup>C/SMBUS PROTOCOL**

The I<sup>2</sup>C/SMBus uses two 'wires', one for clock (SCL) and one for data (SDA). The two wires are connected to the V<sub>CC</sub> supply via pull-up resistors. Master and Slave devices connect to the bus via their respective SCL and SDA pins. The transmitting device pulls down the SDA line to 'transmit' a '0' and releases it to 'transmit' a '1'.

Data transfer may be initiated only when the bus is not busy (see A.C. Characteristics).

During data transfer, the SDA line must remain stable while the SCL line is HIGH. An SDA transition while SCL is HIGH will be interpreted as a START or STOP condition (Figure 1).

### **START**

The START condition precedes all commands. It consists of a HIGH to LOW transition on SDA while SCL is HIGH. The START acts as a 'wake-up' call to all Slaves. Absent a START, a Slave will not respond to commands.

### **STOP**

The STOP condition completes all commands. It consists of a LOW to HIGH transition on SDA while SCL is HIGH. The STOP tells the Slave that no more data will be written to or read from the Slave.

### **DEVICE ADDRESSING**

The Master initiates data transfer by creating a START condition on the bus. The Master then broadcasts an 8-bit serial Slave address. The first 4 bits of the Slave address (the preamble) select either the Temperature Sensor (TS preamble = 0011) or some other device sharing the bus, as shown in Figure 2. The next 3 bits, A2, A1 and A0, select one of 8 possible TS Slave devices. The last bit, R/ $\bar{W}$ , specifies whether a Read (1) or Write (0) operation is being performed

### **ACKNOWLEDGE**

A matching Slave address is acknowledged (ACK) by the Slave by pulling down the SDA line during the 9<sup>th</sup> clock cycle (Figure 3). After that, the Slave will acknowledge all data bytes sent to the bus by the Master. When the Slave is the transmitter, the Master will in turn acknowledge data bytes in the 9<sup>th</sup> clock cycle. The Slave will stop transmitting after the Master does not respond with acknowledge (NoACK) and then issues a STOP. Bus timing is illustrated in Figure 4.

Figure 1. Start/Stop Timing

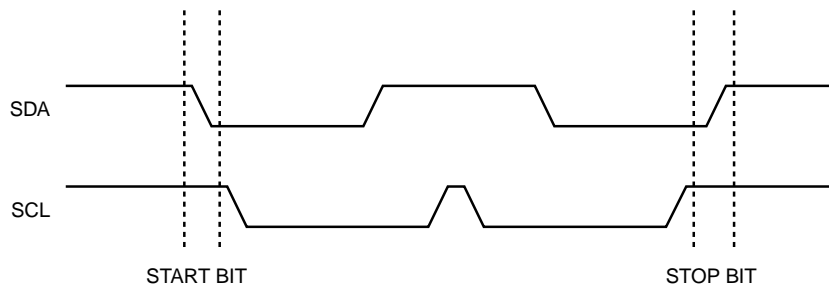

Figure 2. Slave Address Bits

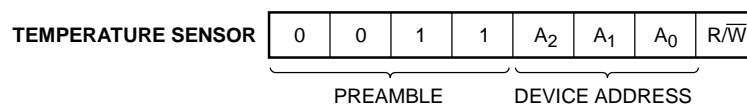

Figure 3. Acknowledge Timing

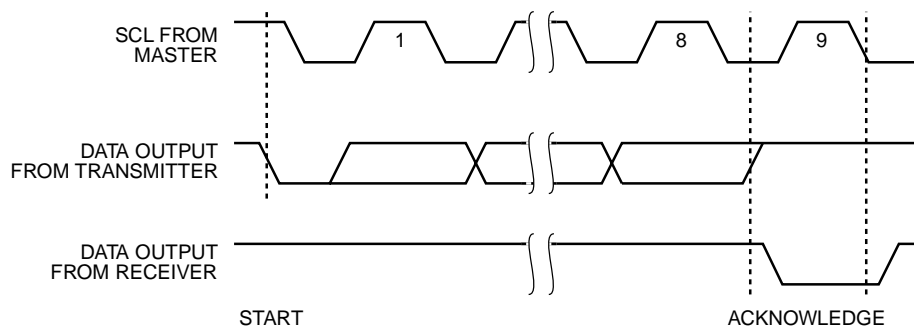
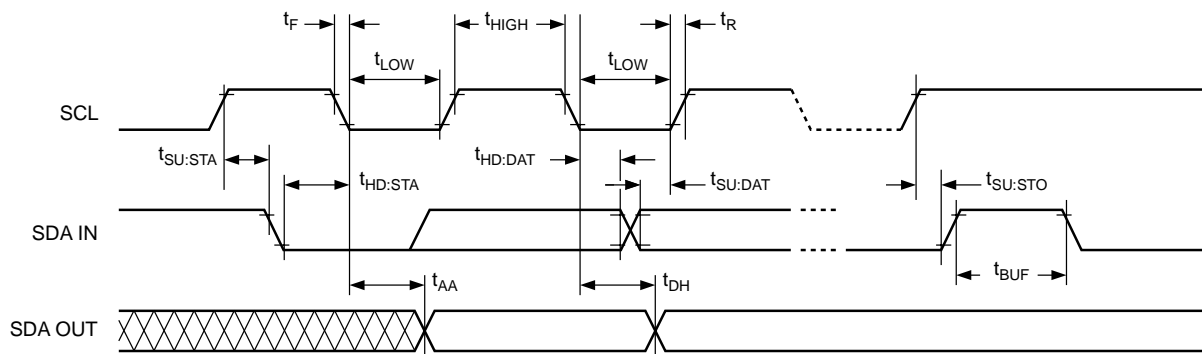

Figure 4. Bus Timing



## **WRITE OPERATIONS**

### **Temperature Sensor Register Write**

To write data to a TS register the Master creates a START condition on the bus, and then sends out the appropriate Slave address (with the R/ $\bar{W}$  bit set to '0'), followed by an address byte and two data bytes. The matching Slave will acknowledge the Slave address, TS register address and the TS register data (Figure 5). The Master then ends the session by creating a STOP condition on the bus. The STOP completes the TS register update. Note that all registers in the TS are 'volatile' meaning any data contained in them is lost when power is removed from the chip.

## **READ OPERATIONS**

### **Immediate Read**

Upon power-up, the Temperature Sensor (TS) address counter is initialized to 00h. The TS address counter will thus point to the Capability Register. This address counter may be updated by subsequent operations.

A CAT6095 presented with a Slave address containing a '1' in the R/ $\bar{W}$  position will acknowledge the Slave address and will then start transmitting data being pointed at by the current TS register address counter. The Master stops this transmission by responding with NoACK, followed by a STOP (Figure 6).

### **Selective Read**

The Read operation can be started at an address different from the one stored in the address counter, by preceding the Immediate Read sequence with a 'data less' Write operation. The Master sends out a START, Slave address and address byte, but rather than following up with data (as in a Write operation), the Master then issues another START and continues with an Immediate Read sequence (Figure 7)



Figure 5. Temperature Sensor Register Write

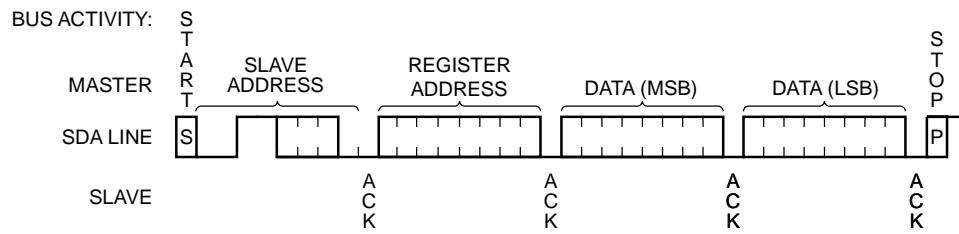

Figure 6. Immediate Read

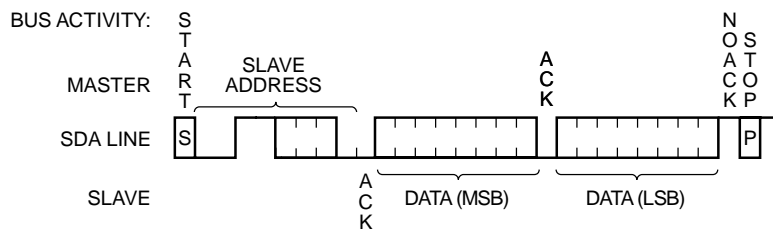
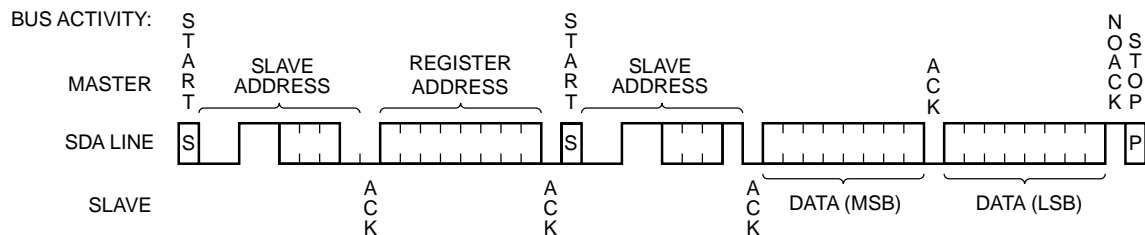

Figure 7. Selective Read



## TEMPERATURE SENSOR OPERATION

The TS component in the CAT6095 combines a Proportional to Absolute Temperature (PTAT) sensor with a  $\Sigma$ - $\Delta$  modulator, yielding a 12 bit (13 bit including sign) digital temperature representation.

The TS is free running on an internal clock, and starts a conversion cycle at least every 100ms. The result of the conversion is stored in the **Temperature Value (TV) Register**. While a conversion is in progress, attempts at reading the **TV** register will yield temperature values corresponding to the previous conversion. **TV** register contents are retained during Shut-down periods.

At the end of the conversion cycle, the value stored in the **TV** register is compared against limit values stored in the **Alarm Temperature Upper Boundary Trip**, the **Alarm Temperature Lower Boundary Trip** and **Critical Temperature Trip** registers. If the measured value is outside the boundary limits or above the critical limit, then the **EVENT** pin may be activated. The **EVENT** output function is programmable, via the **Configuration Register** for interrupt mode, comparator mode and polarity.

The temperature limit registers can be Read or Written by the host, via the serial interface. At power-on, these registers are initialized to default values, and should be updated by the host to the desired values.

## REGISTERS

The CAT6095 contains eight 16-bit wide registers allocated to TS functions, as shown in Table 1. Upon power-up, the internal address counter points to the capability register.

### Capability Register (User Read Only)

This register lists the capabilities of the TS, as detailed in the corresponding bit map.

### Configuration Register (Read/Write)

This register controls the various operating modes of the TS, as detailed in the corresponding bit map.

### Temperature Trip Point Registers (Read/Write)

The CAT6095 features 3 temperature limit registers. They are the Alarm Temperature Upper Boundary Trip register, the Alarm Temperature Lower Boundary Trip register, and the Critical Temperature Trip register. The **TV** register contents are compared to the various

limit values, and the resulting event may be used to activate the **EVENT** pin. To avoid superfluous **EVENT** pin activity, this pin can be disabled while updating the limit registers. The pin may be re-enabled, as soon as a valid comparison can be expected. The format of the limit registers is detailed in the corresponding bit maps. Data format is two's complement with the LSB representing 0.25°C.

### Testing Temperature Trip Point Operation

A common technique for verifying temperature trip points and operation of the upper, lower and critical temperature threshold limits is to maintain a fixed temperature and 'sweep' the trigger limits.

This completely digital technique is faster when compared to raising and/or lowering the device temperature itself (as would happen during normal operation). In the present implementation of the CAT6095, this method may yield false results, since the various flag bits representing the relation between actual temperature and limit values, are updated only at the end of a conversion cycle, rather than all the time. Therefore, the flag bits may take on the correct value as late as perhaps 100 ms after the limit registers have been reset and an attempt at reading the **TV** register is made. Automated programs used in testing temperature sensors would need to take this delay into account in order to produce meaningful results.

### Temperature Value Register (User Read Only)

This register stores the trip status and the temperature measured by the TS, as detailed in the corresponding bit map. The temperature is stored in a 13-bit, two's complement format, with the MSB (D12) representing the sign. The next bit (D11) represents 128°C, and the LSB (D0) represents 0.0625°C. D15, D14 and D13 are the trip status bits, representing the internal temperature trip detection and are not affected by the status of the event or configuration bits. When both the 'above' (D14) and the 'below' (D13) bits are '0', the current temperature reading is within alarm window boundaries, as defined in the configuration register.

### Device ID and Revision Register (Read Only)

The manufacturer assigns the device ID and device revision. The device revision starts at 0 and is incremented by 1 whenever the manufacturer issues an update to the device. The format of this register is detailed in the corresponding bit map.

Table 1. Temperature Sensor Register Set

Register Address	Register Name	Power-On Default	Read/Write
0x00	Capability Register	0x001F	Read
0x01	Configuration Register	0x0000	Read/Write
0x02	Alarm Temperature Upper Boundary Trip Register	0x0400	Read/Write
0x03	Alarm Temperature Lower Boundary Trip Register	0x00A0	Read/Write
0x04	Critical Temperature Trip Register	0x0500	Read/Write
0x05	Temperature Value Register	Undefined	Read
0x06	Manufacturer ID Register	0x1B09	Read
0x07	Device ID/Revision Register	0x080X	Read
0x07	Device ID/Revision Register	0x080X	Read
0x08 – 0xFF <sup>(1)</sup>	Reserved	–	–

## CAPABILITY REGISTER

MSB

LSB

D15	D14	D13	D12	D11	D10	D9	D8	D7	D6	D5	D4	D3	D2	D1	D0
0	0	0	0	0	0	0	0	0	0	0	Resolution		Range	Accuracy	Trip Mode

Bit	Description
D0	1: Alarm and Critical Temperature
D1	1: $\pm 1^{\circ}\text{C}$ over the active range and $\pm 2^{\circ}\text{C}$ over the monitor range (= JEDEC 42.4 Class B)
D2	1: Positive and Negative Temperature
D4:D3	11: LSB = $0.0625^{\circ}\text{C}$
D15:D5	Reserved for future use; must be 0

## Notes:

- (1) Attempts to read from register addresses 0x08 - 0xFF will return NoACK and the content of the last accessed register is output as data. If no register was accessed (read or written) after power-up, the content of the Capability Register (address 0x00, value 0x001F) is output.

CONFIGURATION REGISTER

MSB														LSB	
D15	D14	D13	D12	D11	D10	D9	D8	D7	D6	D5	D4	D3	D2	D1	D0
0	0	0	0	0	Hysteresis		Shut-down mode	Critical lock bit	Alarm lock bit	Clear event	Event output status	Event output control	Critical event only	Event polarity	Event mode

Bit	Description
D0 <sup>(1)</sup>	0: Comparator mode (default) 1: Interrupt mode
D1 <sup>(1)</sup>	0: Active low (default) 1: Active high.
D2 <sup>(1)</sup>	0: EVENT output triggered by alarm or critical temperature event (default) 1: EVENT output triggered by critical temperature event only
D3 <sup>(1)</sup>	0: EVENT output disabled (default) 1: EVENT output enabled
D4 <sup>(2)</sup>	0: EVENT output pin is not being asserted (default) 1: EVENT output pin is being asserted as a result of an alarm or a critical temperature event
D5 <sup>(3)</sup>	0: No effect (default) 1: Clears an active event in interrupt mode only
D6 <sup>(4)</sup>	0: Alarm trip registers can be altered (default) 1: Alarm trip registers cannot be altered
D7 <sup>(4)</sup>	0: Critical trip register can be altered (default) 1: Critical trip register cannot be altered
D8 <sup>(4), (5)</sup>	0: Thermal Sensor (TS) enabled (default) 1: Thermal Sensor (TS) shut down
D10:D9	00: Disable hysteresis (default) 01: Set hysteresis at 1.5°C 10: Set hysteresis at 3°C 11: Set hysteresis at 6°C

Notes:

- (1) Can not be written as long as either one of the two lock bits (D6 or D7) is set.
- (2) The actual cause of an event can be determined by reading the temperature value registers. Interrupt events can be cleared by writing to the clear event bit (D5). This is a read-only bit.
- (3) Writing to this bit has no effect in comparator mode. When read, this bit always returns 0. Once the DUT temperature is greater than the critical temperature, an event cannot be cleared (see Figure 5).
- (4) Cleared at power-on reset (POR). Once set, this bit can only be cleared by a POR condition.
- (5) When the device is shut down, both the band-gap and the ADC are disabled to save power, and no events are generated. Attempts to set this bit are ignored, as long as either one of the two lock bits (D6 or D7) is set. However, the bit can be cleared at any time.

## ALARM TEMPERATURE UPPER BOUNDARY TRIP REGISTER

			Sign MSB									LSB			
D15	D14	D13	D12	D11	D10	D9	D8	D7	D6	D5	D4	D3	D2	D1	D0
0	0	0	Alarm window upper boundary temperature											0	0

## ALARM TEMPERATURE LOWER BOUNDARY TRIP REGISTER

			Sign MSB									LSB			
D15	D14	D13	D12	D11	D10	D9	D8	D7	D6	D5	D4	D3	D2	D1	D0
0	0	0	Alarm window lower boundary temperature											0	0

## CRITICAL TEMPERATURE TRIP REGISTER

			Sign MSB									LSB			
D15	D14	D13	D12	D11	D10	D9	D8	D7	D6	D5	D4	D3	D2	D1	D0
0	0	0	Critical temperature											0	0

## TEMPERATURE VALUE REGISTER

			Sign MSB									LSB			
D15	D14	D13	D12	D11	D10	D9	D8	D7	D6	D5	D4	D3	D2	D1	D0
Above critical trip	Above alarm window	Below alarm window	Temperature												

Bit	Description
D13	0: Temperature is equal to or above the alarm window lower boundary temperature 1: Temperature is below the alarm window lower boundary temperature
D14	0: Temperature is equal to or below the alarm window upper boundary temperature. 1: Temperature is above the alarm window upper boundary temperature
D15	0: Temperature is below the critical temperature setting 1: Temperature is equal to or above the critical temperature setting

## REGISTER DATA FORMAT

The values used in the temperature value register and the 3 temperature trip point registers are expressed in two's complement format. The measured temperature value is expressed with 12-bit resolution, while the 3 trip temperature limits are set with 10-bit resolution. The total temperature range is arbitrarily defined as 256°C, thus yielding an LSB of 0.0625°C for the measured temperature and 0.25°C for the 3 limit settings. Bit D12 in all temperature registers represents the sign, with a '0' indicating a positive, and a '1' a negative value. In two's complement format, negative values are obtained by complementing their positive counterpart and adding a '1', so that the sum of opposite signed numbers, but of equal absolute value, adds up to zero.

Note that trailing '0' bits, are '0' irrespective of polarity. Therefore the don't care bits (D1 and D0) in the 10-bit resolution temperature limit registers, are always '0'. Also note that temperatures below -20°C will produce erroneous readings.

### 12-Bit Temperature Data Format

Binary (D12 to D0)	Hex	Temperature
1 1110 1100 0000	1EC0	-20°C
1 1111 1111 1111	1FFF	-0.0625°C
0 0000 0000 0000	000	0°C
0 0000 0000 0001	001	+0.0625°C
0 0001 1001 0000	190	+25°C
0 0011 0010 0000	320	+50°C
0 0111 1101 0000	7D0	+125°C

## EVENT PIN FUNCTIONALITY

The EVENT output reacts to temperature changes as illustrated in Figure 8, and according to the operating mode defined by the Configuration register.

In **Interrupt Mode** the EVENT output can be asserted every time the temperature crosses one of the alarm window limits, and can be de-asserted by writing a '1' to the clear event bit in the configuration register. When the temperature exceeds the critical limit, the device switches to comparator mode and EVENT remains asserted as long as the temperature stays above the critical limit (setting the clear event bit will have no effect in this case). When the temperature drops below the critical limit, the device switches back to either interrupt or comparator mode, as programmed in the configuration register.

In **Comparator Mode**, the EVENT output is asserted outside the alarm window limits, while in **Critical Temperature Mode**, EVENT is asserted only above the critical limit. The exact trip limits are determined by the 3 temperature limit settings and the hysteresis offsets, as dictated by the corresponding Configuration register bits (see also Figure 9).

The EVENT output will retain the state preceding a shut-down command.

Figure 8. Event Detail

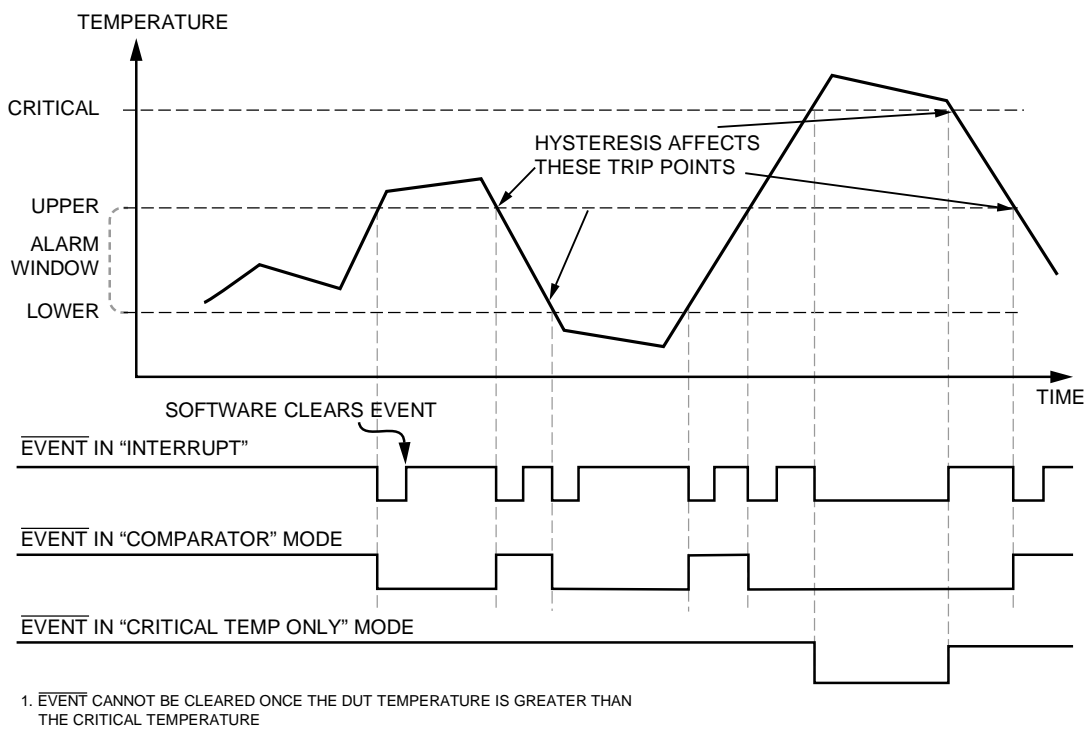
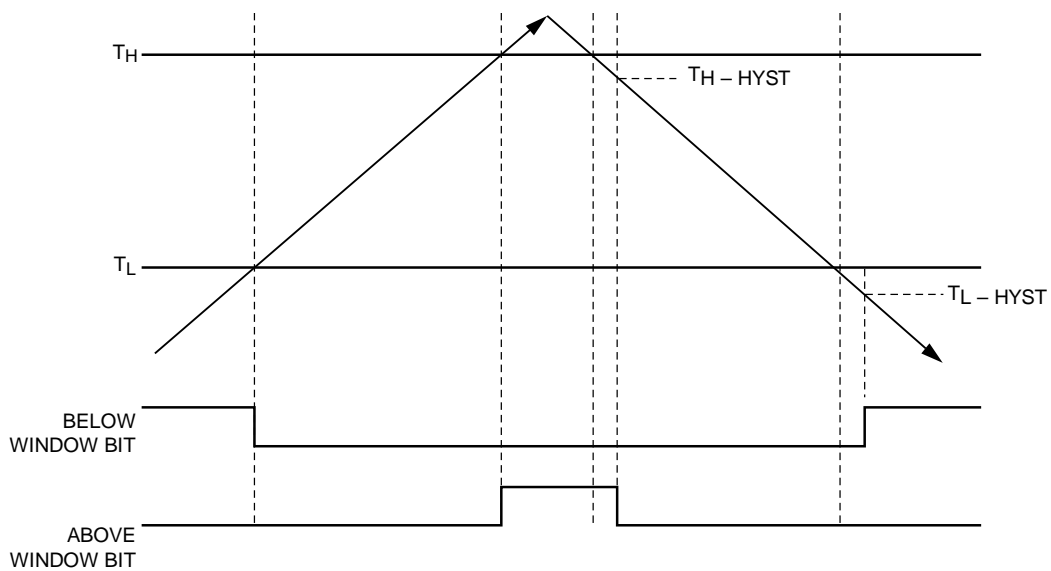

Figure 9. Hysteresis Detail



**TYPICAL CHARACTERISTICS**

$V_{CC} = 3.3V$ , unless otherwise specified.

**Quiescent Current vs. Temperature**

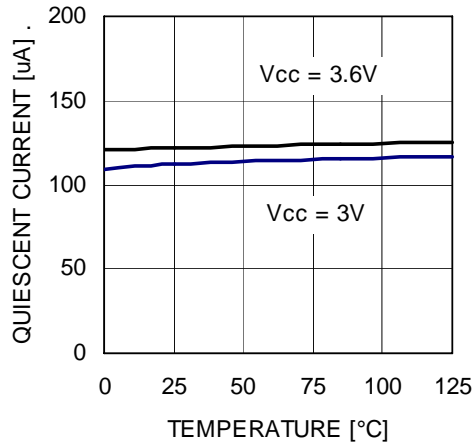

**Accuracy vs. Temperature**

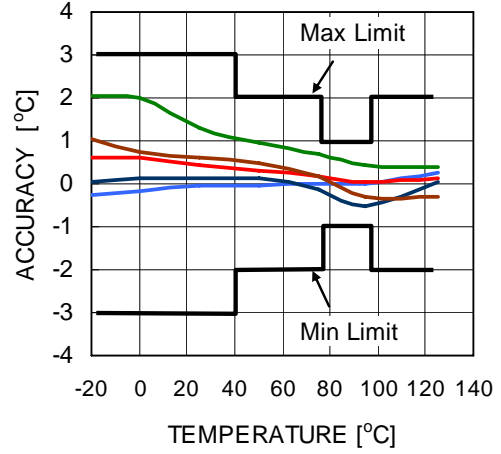



PACKAGE OUTLINE DRAWINGS

TDFN 8-Pad 2 x 3mm (VP2)<sup>(1)(2)</sup>

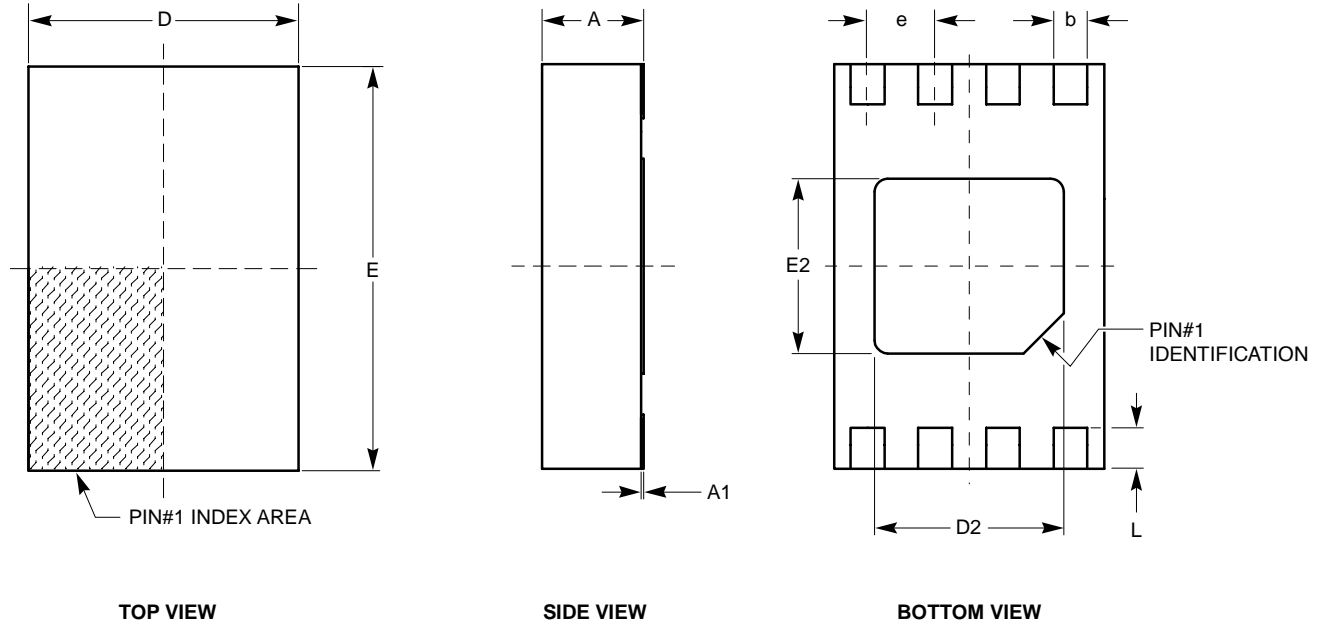

SYMBOL	MIN	NOM	MAX
A	0.70	0.75	0.80
A1	0.00	0.02	0.05
A2	0.45	0.55	0.65
A3	0.20 REF		
b	0.20	0.25	0.30
D	1.90	2.00	2.10
D2	1.30	1.40	1.50
E	2.90	3.00	3.10
E2	1.20	1.30	1.40
e	050 TYP		
L	0.20	0.30	0.40

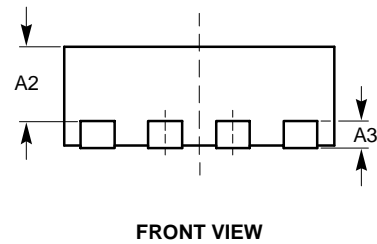

For current Tape and Reel information, download the PDF file from:  
<http://www.catsemi.com/documents/tapeandreeel.pdf>.

Notes:

- (1) All dimensions are in millimeters.
- (2) Complies with JEDEC standard MO-229.

UDFN 8-Pad 2 x 3 x 0.5mm (HU3)<sup>(1)(2)</sup>

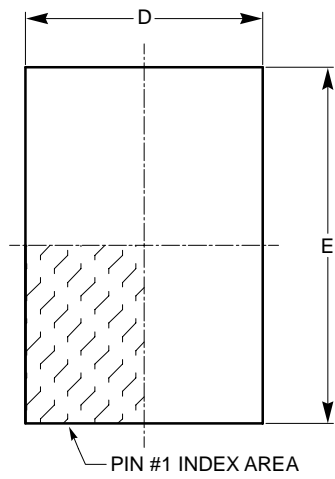

TOP VIEW

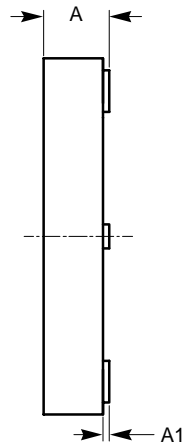

SIDE VIEW

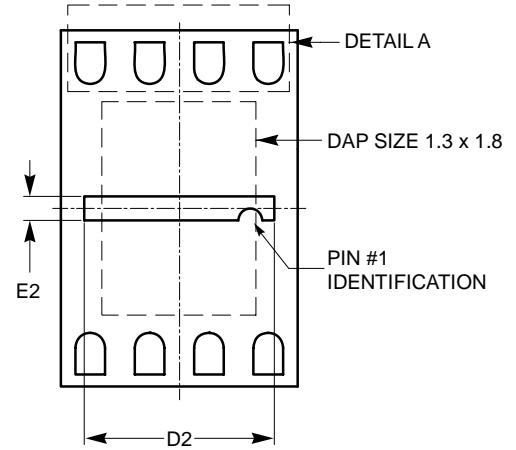

BOTTOM VIEW

SYMBOL	MIN	NOM	MAX
A	0.45	0.50	0.55
A1	0.00	0.02	0.05
A3	0.127 REF		
b	0.20	0.25	0.30
D	1.90	2.00	2.10
D2	1.50	1.60	1.70
E	2.90	3.00	3.10
E2	0.10	0.20	0.30
e	0.50 TYP		
K	0.10 REF		
L	0.30	0.35	0.40

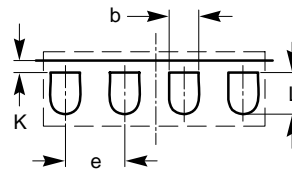

DETAIL A

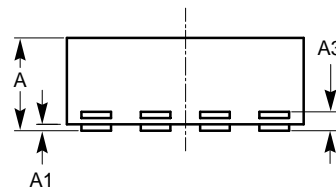

FRONT VIEW

For current Tape and Reel information, download the PDF file from:  
<http://www.catsemi.com/documents/tapeand reel.pdf>.

Notes:

- (1) All dimensions are in millimeters.
- (2) Complies with JEDEC standard MO-229.

## EXAMPLE OF ORDERING INFORMATION

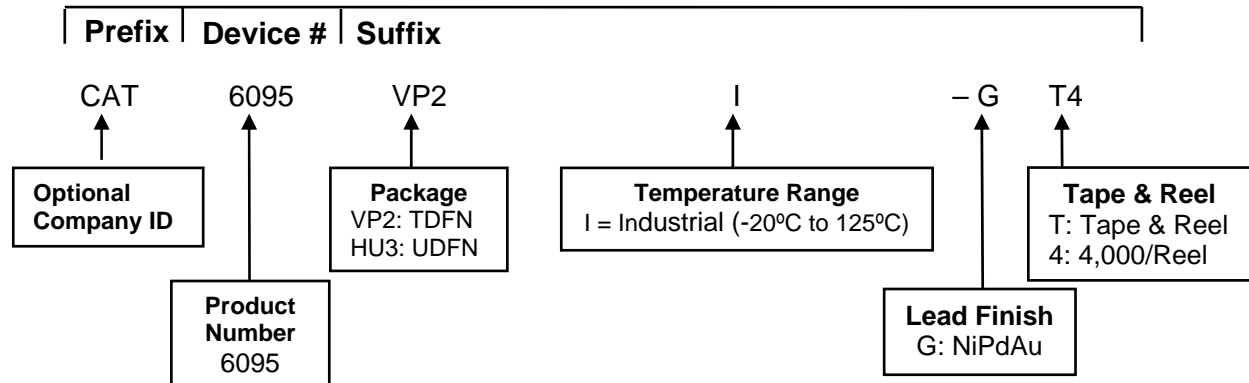

**For Product Top Mark Codes, click here:**  
<http://www.catsemi.com/techsupport/producttopmark.asp>

**Notes:**

- (1) All packages are RoHS-compliant (Lead-free, Halogen-free).
- (2) The standard lead finish is NiPdAu.
- (3) This device used in the above example is a CAT6095VP2I-GT4 (i.e. TDFN, Industrial Temperature, NiPdAu, Tape & Reel, 4,000/Reel).
- (4) For additional package and temperature options, please contact your nearest ON Semiconductor Sales office.

**REVISION HISTORY**

Date	Revision	Description
16-Sept-08	A	Initial Release
3-Nov-08	B	Change logo and fine print to ON Semiconductor

ON Semiconductor and  are registered trademarks of Semiconductor Components Industries, LLC (SCILLC). SCILLC reserves the right to make changes without further notice to any products herein. SCILLC makes no warranty, representation or guarantee regarding the suitability of its products for any particular purpose, nor does SCILLC assume any liability arising out of the application or use of any product or circuit, and specifically disclaims any and all liability, including without limitation special, consequential or incidental damages. "Typical" parameters which may be provided in SCILLC data sheets and/or specifications can and do vary in different applications and actual performance may vary over time. All operating parameters, including "Typicals" must be validated for each customer application by customer's technical experts. SCILLC does not convey any license under its patent rights nor the rights of others. SCILLC products are not designed, intended, or authorized for use as components in systems intended for surgical implant into the body, or other applications intended to support or sustain life, or for any other application in which the failure of the SCILLC product could create a situation where personal injury or death may occur. Should Buyer purchase or use SCILLC products for any such unintended or unauthorized application, Buyer shall indemnify and hold SCILLC and its officers, employees, subsidiaries, affiliates, and distributors harmless against all claims, costs, damages, and expenses, and reasonable attorney fees arising out of, directly or indirectly, any claim of personal injury or death associated with such unintended or unauthorized use, even if such claim alleges that SCILLC was negligent regarding the design or manufacture of the part. SCILLC is an Equal Opportunity/Affirmative Action Employer. This literature is subject to all applicable copyright laws and is not for resale in any manner.

**PUBLICATION ORDERING INFORMATION**

**LITERATURE FULFILLMENT:**

**Literature Distribution Center for ON Semiconductor**  
 P.O. Box 5163, Denver, Colorado 80217 USA  
**Phone:** 303-675-2175 or 800-344-3860 Toll Free USA/Canada  
**Fax:** 303-675-2176 or 800-344-3867 Toll Free USA/Canada  
**Email:** orderlit@onsemi.com

**N. American Technical Support:** 800-282-9855 Toll Free  
 USA/Canada  
**Europe, Middle East and Africa Technical Support:**  
 Phone: 421 33 790 2910  
**Japan Customer Focus Center:**  
 Phone: 81-3-5773-3850

**ON Semiconductor Website:** [www.onsemi.com](http://www.onsemi.com)  
**Order Literature:** <http://www.onsemi.com/orderlit>  
 For additional information, please contact your local Sales Representative