

W83697HF/F
WINBOND I/O

W83697HF/F Data Sheet Revision History

	Pages	Dates	Version	Version on Web	Main Contents
1	n.a.	08/23/99	0.40		First published. For Beta Site customers only
2	98, 107, 116	11/15/99	0.41		H/W monitor register correction
3	All	11/15/2000	0.50		New composition
4	All	9/3/2001	0.6		Add W83697F pin assignment & Notice
5		2/19/2002	0.7		New Update
6					
7					
8					
9					
10					

Please note that all data and specifications are subject to change without notice. All the trade marks of products and companies mentioned in this data sheet belong to their respective owners.

LIFE SUPPORT APPLICATIONS

These products are not designed for use in life support appliances, devices, or systems where malfunction of these products can reasonably be expected to result in personal injury. Winbond customers using or selling these products for use in such applications do so at their own risk and agree to fully indemnify Winbond for any damages resulting from such improper use or sales.



TABLE OF CONTENTS

GENERAL DESCRIPTION	1
1. PIN DESCRIPTION	5
1.1 LPC INTERFACE.....	6
1.2 FDC INTERFACE.....	7
1.3 MULTI-MODE PARALLEL PORT	8
1.4 SERIAL PORT INTERFACE.....	13
1.5 INFRARED PORT	14
1.6 FRESH ROM INTERFACE	14
1.7 HARDWARE MONITOR INTERFACE	15
1.8 GAME PORT & MIDI PORT	16
1.9 POWER PINS.....	17
2. LPC (LOW PIN COUNT) INTERFACE.....	18
3. FDC FUNCTIONAL DESCRIPTION.....	19
3.1 W83697HF FDC.....	19
3.1.1 AT interface.....	19
3.1.2 FIFO (Data).....	19
3.1.3 Data Separator.....	20
3.1.4 Write Precompensation.....	20
3.1.5 FDC Core	21
3.1.6 FDC Commands	21
3.1.7 FDC Commands	21
3.2 REGISTER DESCRIPTIONS	34
3.2.1 Status Register A (SA Register) (Read base address + 0).....	34
3.2.2 Status Register B (SB Register) (Read base address + 1).....	36
3.2.3 Digital Output Register (DO Register) (Write base address + 2).....	38
3.2.4 Tape Drive Register (TD Register) (Read base address + 3).....	38
3.2.5 Main Status Register (MS Register) (Read base address + 4).....	39



3.2.6	Data Rate Register (DR Register) (Write base address + 4).....	40
3.2.7	FIFO Register (R/W base address + 5).....	41
3.2.8	Digital Input Register (DI Register) (Read base address + 7).....	44
3.2.9	Configuration Control Register (CC Register) (Write base address + 7).....	45
4.	UART PORT.....	46
4.1	UNIVERSAL ASYNCHRONOUS RECEIVER/TRANSMITTER (UART A, UART B)	46
4.2	REGISTER ADDRESS	46
4.2.1	UART Control Register (UCR) (Read/Write).....	46
4.2.2	UART Status Register (USR) (Read/Write).....	48
4.2.3	Handshake Control Register (HCR) (Read/Write).....	50
4.2.4	Handshake Status Register (HSR) (Read/Write).....	51
4.2.5	UART FIFO Control Register (UFR) (Write only).....	52
4.2.6	Interrupt Status Register (ISR) (Read only).....	53
4.2.7	Interrupt Control Register (ICR) (Read/Write)	54
4.2.8	Programmable Baud Generator (BLL/BHL) (Read/Write)	54
4.2.9	User-defined Register (UDR) (Read/Write).....	55
5.	CIR RECEIVER PORT.....	56
5.1	CIR REGISTERS	56
5.1.1	Bank0.Reg0- Receiver Buffer Registers (RBR) (Read)	56
5.1.2	Bank0.Reg1- Interrupt Control Register (ICR)	56
5.1.3	Bank0.Reg2- Interrupt Status Register (ISR).....	56
5.1.4	Bank0~3.Reg3 - CIR Control Register 0/Bank Select Register (CTR0/BSR) (BANK0~3).....	57
5.1.5	Bank0.Reg4- CIR Control Register (CTR)	58
5.1.6	Bank0.Reg5- UART Line Status Register (USR)	59
5.1.7	Bank0.Reg6- Remote Infrared Config Register (RIR_CFG).....	59
5.1.8	Bank0.Reg7- User Defined Register (UDR/AUDR)	60
5.1.9	Bank1.Reg0~1 - Baud Rate Divisor Latch (BLL/BHL).....	61
5.1.10	Bank1.Reg2- Version ID Register I (VID)	62
5.1.11	Bank0~3.Reg3 - CIR Control Register 0/Bank Select Register (CTR0/BSR) (BANK0~3)	62
5.1.12	Bank1.Reg4- Timer Low Byte Register (TMRL).....	62
5.1.13	Bank1.Reg5- Timer High Byte Register (TMRH).....	62
6.	PARALLEL PORT.....	63
6.1	PRINTER INTERFACE LOGIC.....	63



6.2 ENHANCED PARALLEL PORT (EPP).....	64
6.2.1 Data Swapper.....	65
6.2.2 Printer Status Buffer.....	65
6.2.3 Printer Control Latch and Printer Control Swapper	66
6.2.4 EPP Address Port.....	66
6.2.5 EPP Data Port 0-3.....	67
6.2.6 Bit Map of Parallel Port and EPP Registers.....	67
6.2.7 EPP Pin Descriptions.....	68
6.2.8 EPP Operation.....	68
6.3 EXTENDED CAPABILITIES PARALLEL (ECP) PORT.....	69
6.3.1 ECP Register and Mode Definitions.....	69
6.3.2 Data and ecpAFifo Port.....	70
6.3.3 Device Status Register (DSR).....	70
6.3.4 Device Control Register (DCR).....	71
6.3.5 cFifo (Parallel Port Data FIFO) Mode = 010.....	72
6.3.6 ecpDFifo (ECP Data FIFO) Mode = 011.....	72
6.3.7 tFifo (Test FIFO Mode) Mode = 110.....	72
6.3.8 cnfgA (Configuration Register A) Mode = 111	72
6.3.9 cnfgB (Configuration Register B) Mode = 111	72
6.3.10 ecr (Extended Control Register) Mode = all	73
6.3.11 Bit Map of ECP Port Registers.....	74
6.3.12 ECP Pin Descriptions.....	75
6.3.13 ECP Operation.....	76
6.3.14 FIFO Operation	76
6.3.15 DMA Transfers.....	77
6.3.16 Programmed I/O (NON-DMA) Mode	77
6.4 EXTENSION FDD MODE (EXTFDD).....	77
6.5 EXTENSION 2FDD MODE (EXT2FDD).....	77
7. GENERAL PURPOSE I/O.....	78
8. ACPI REGISTERS FEATURES	81
9. HARDWARE MONITOR	82
9.1 GENERAL DESCRIPTION	82
9.2 ACCESS INTERFACE.....	82



9.2.1 LPC interface.....	82
9.3 ANALOG INPUTS.....	84
9.3.1 Monitor over 4.096V voltage:.....	84
9.3.2 Monitor negative voltage:.....	85
9.3.3 Temperature Measurement Machine.....	86
9.4 FAN SPEED COUNT AND FAN SPEED CONTROL.....	87
9.4.1 Fan speed count.....	87
9.4.2 Fan speed control.....	89
9.5 SMI# INTERRUPT MODE.....	90
9.5.1 Voltage SMI# mode :.....	90
9.5.2 Fan SMI# mode :.....	90
9.5.3 Temperature SMI# mode.....	91
9.5.4 The W83697HF temperature sensor 2 and sensor 3 SMI# interrupt has two modes and it is programmed at CR[4Ch] bit 6.....	92
9.6 OVT# INTERRUPT MODE.....	93
9.7 REGISTERS AND RAM.....	94
9.7.1 Address Register (Port x5h).....	94
9.7.2 Data Register (Port x6h).....	97
9.7.3 Configuration Register ¾Index 40h.....	97
9.7.4 Interrupt Status Register 1¾Index 41h.....	98
9.7.5 Interrupt Status Register 2 ¾Index 42h.....	98
9.7.6 SMI# Mask Register 1 ¾Index 43h.....	99
9.7.7 SMI# Mask Register 2 ¾Index 44h.....	99
9.7.8 Reserved Register ¾Index 45h.....	100
9.7.9 Chassis Clear Register -- Index 46h.....	100
9.7.10 VID/Fan Divisor Register ¾Index 47h.....	100
9.7.11 Value RAM ¾Index 20h- 3Fh or 60h - 7Fh (auto-increment).....	101
9.7.12 Device ID Register - Index 49h.....	102
9.7.13 Pin Control Register - Index 4Bh.....	102
9.7.14 SMI#/OVT# Property Select Register- Index 4Ch.....	103
9.7.15 FAN IN/OUT and BEEP Control Register- Index 4Dh.....	103
9.7.16 Register 50h ~ 5Fh Bank Select Register- Index 4Eh (No Auto Increase).....	104
9.7.17 Winbond Vendor ID Register - Index 4Fh (No Auto Increase).....	105
9.7.18 Winbond Test Register-- Index 50h - 55h (Bank 0).....	105
9.7.19 BEEP Control Register 1-- Index 56h (Bank 0).....	105



9.7.20 BEEP Control Register 2-- Index 57h (Bank 0).....	106
9.7.21 Chip ID -- Index 58h (Bank 0).....	107
9.7.22 Reserved Register -- Index 59h (Bank 0).....	107
9.7.23 PWMOUT1 Control -- Index 5Ah (Bank 0).....	108
9.7.24 PWMOUT2 Control -- Index 5Bh (Bank 0).....	108
9.7.25 PWMOUT1/2 Clock Select -- Index 5Ch (Bank 0).....	108
9.7.26 VBAT Monitor Control Register -- Index 5Dh (Bank 0).....	108
9.7.27 Reserved Register-- 5Eh (Bank 0).....	109
9.7.28 Reserved Register -- Index 5Fh (Bank 0).....	109
9.7.29 Temperature Sensor 2 Temperature (High Byte) Register - Index 50h (Bank 1).....	109
9.7.30 Temperature Sensor 2 Temperature (Low Byte) Register - Index 51h (Bank 1).....	109
9.7.31 Temperature Sensor 2 Configuration Register - Index 52h (Bank 1).....	110
9.7.32 Temperature Sensor 2 Hysteresis (High Byte) Register - Index 53h (Bank 1).....	110
9.7.33 Temperature Sensor 2 Hysteresis (Low Byte) Register - Index 54h (Bank 1).....	111
9.7.34 Temperature Sensor 2 Over-temperature (High Byte) Register - Index 55h (Bank 1).....	111
9.7.35 Temperature Sensor 2 Over-temperature (Low Byte) Register - Index 56h (Bank 1).....	112
9.7.36 Interrupt Status Register 3 -- Index 50h (BANK4).....	112
9.7.37 SMI# Mask Register 3 -- Index 51h (BANK 4)	113
9.7.38 Reserved Register-- Index 52h (Bank 4).....	113
9.7.39 BEEP Control Register 3-- Index 53h (Bank 4).....	113
9.7.40 Temperature Sensor 1 Offset Register -- Index 54h (Bank 4).....	114
9.7.41 Temperature Sensor 2 Offset Register -- Index 55h (Bank 4).....	114
9.7.42 Reserved Register-- Index 57h--58h.....	114
9.7.43 Real Time Hardware Status Register I -- Index 59h (Bank 4).....	115
9.7.44 Real Time Hardware Status Register II -- Index 5Ah (Bank 4).....	115
9.7.45 Real Time Hardware Status Register III -- Index 5Bh (Bank 4).....	116
9.7.46 Reserved Register-- Index 5Ch (Bank 4).....	117
9.7.47 VID Output Register -- Index 5Dh (Bank 4).....	117
9.7.48 Value RAM 2¾Index 50h- 5Ah (auto-increment) (BANK 5).....	117
9.7.49 Winbond Test Register -- Index 50h (Bank 6).....	117
9.7.50 FAN 1 Pre-Scale Register ndex00h.....	117
9.7.51 FAN 1 Duty Cycle Select Register-- 01h (Bank 0).....	118
9.7.52 FAN 2 Pre-Scale Register-- Index 02h.....	118
9.7.53 FAN2 Duty Cycle Select Register-- Index 03h	119
9.7.54 FAN Configuration Register-- Index 04h.....	119



9.7.55 CPUT1 Target Temperature Register/ Fan 1 Target Speed Register -- Index 05h..... 120

9.7.56 CPUT2 Target Temperature Register/ Fan 2 Target Speed Register -- Index 06h..... 120

9.7.57 Tolerance of Target Temperature or Target Speed Register -- Index 07h 121

9.7.58 Fan 1 PWM Stop Duty Cycle Register -- Index 08h 121

9.7.59 Fan 2 PWM Stop Duty Cycle Register -- 09h (Bank 0)..... 121

9.7.60 Fan 1 Start-up Duty Cycle Register -- Index 0Ah 122

9.7.61 Fan 2 Start-up Duty Cycle Register -- Index 0Bh 122

9.7.62 Fan 1 Stop Time Register -- Index 0Ch..... 122

9.7.63 Fan 2 Stop Time Register -- Index 0Dh 122

9.7.64 Fan Step Down Time Register -- Index 0Eh 123

9.7.65 Fan Step Up Time Register -- Index 0Fh 123

10. CONFIGURATION REGISTER..... 124

10.1 PLUG AND PLAY CONFIGURATION 124

10.2 COMPATIBLE PNP 124

 10.2.1 Extended Function Registers..... 124

 10.2.2 Extended Functions Enable Registers (EFERs)..... 125

 10.2.3 Extended Function Index Registers (EFIRs), Extended Function Data Registers(EFDRs)..... 125

10.3 CONFIGURATION SEQUENCE 126

 10.3.1 Enter the extended function mode..... 126

 10.3.2 Configure the configuration registers 126

 10.3.3 Exit the extended function mode..... 126

 10.3.4 Software programming example..... 126

10.4 CHIP (GLOBAL) CONTROL REGISTER..... 128

10.5 LOGICAL DEVICE 0 (FDC)..... 132

10.6 LOGICAL DEVICE 1 (PARALLEL PORT) 136

10.7 LOGICAL DEVICE 2 (UART A)..... 137

10.8 LOGICAL DEVICE 3 (UART B) 137

10.9 LOGICAL DEVICE 6 (CIR)..... 139

10.10 LOGICAL DEVICE 7 (GAME PORT GPIO PORT 1)..... 139

10.11 LOGICAL DEVICE 8 (MIDI PORT AND GPIO PORT 5)..... 140

10.12 LOGICAL DEVICE 9 (GPIO PORT 2 ~ GPIO PORT 4)..... 142

10.13 LOGICAL DEVICE A (ACPI)..... 144

10.14 LOGICAL DEVICE B (HARDWARE MONITOR)..... 148



11. ORDERING INSTRUCTION.....	149
12. HOW TO READ THE TOP MARKING.....	149
13. PACKAGE DIMENSIONS.....	150



GENERAL DESCRIPTION

The W83697HF is evolving product from Winbond's most popular I/O family. They feature a whole new interface, namely LPC (**Low Pin Count**) interface, which will be supported in the new generation chip-set. This interface as its name suggests is to provide an economical implementation of I/O's interface with lower pin count and still maintains equivalent performance as its ISA interface counterpart. Approximately 40 pin counts are saved in LPC I/O comparing to ISA implementation. With this additional freedom, we can implement more devices on a single chip as demonstrated in W83697HF's integration of Game Port and MIDI Port. It is fully transparent in terms of software which means no BIOS or device driver update is needed except chip-specific configuration.

The disk drive adapter functions of W83697HF include a floppy disk drive controller compatible with the industry standard 82077/ 765, data separator, write pre-compensation circuit, decode logic, data rate selection, clock generator, drive interface control logic, and interrupt and DMA logic. The wide range of functions integrated onto the W83697HF greatly reduces the number of components required for interfacing with floppy disk drives. The W83697HF supports four 360K, 720K, 1.2M, 1.44M, or 2.88M disk drives and data transfer rates of 250 Kb/s, 300 Kb/s, 500 Kb/s, 1 Mb/s, and 2 Mb/s.

The W83697HF provides two high-speed serial communication ports (UARTs), one of which supports serial Infrared communication. Each UART includes a 16-byte send/receive FIFO, a programmable baud rate generator, complete modem control capability, and a processor interrupt system. Both UARTs provide legacy speed with baud rate up to 115.2k bps and also advanced speed with baud rates of **230k**, **460k**, or **921k bps** which support higher speed modems. In addition, the W83697HF provides IR functions: **IrDA 1.0 (SIR** for 1.152K bps) and TV remote IR (**Consumer IR**, supporting NEC, RC-5, extended RC-5, and RECS-80 protocols).

The W83697HF supports one PC-compatible printer port (SPP), Bi-directional Printer port (BPP) and also Enhanced Parallel Port (EPP) and Extended Capabilities Port (ECP). Through the printer port interface pins, also available are: Extension FDD Mode and Extension 2FDD Mode allowing one or two external floppy disk drives to be connected.

The configuration registers support mode selection, function enable/disable, and power down function selection. Furthermore, the configurable PnP features are compatible with the plug-and-play feature demand of Windows 95/98™, which makes system resource allocation more efficient than ever.

The W83697HF provides a set of flexible I/O control functions to the system designer through a set of General Purpose I/O ports. These GPIO ports may serve as simple I/O or may be individually configured to provide a predefined alternate function. General Purpose Port 1 is designed to be functional even in power down mode (VCC is off).

The W83697HF is made to fully comply with **Microsoft[®] PC98 and PC99 Hardware Design Guide, and meet the requirements of ACPI.**

The W83697HF contains a game port and a MIDI port. The game port is designed to support 2 joysticks and can be applied to all standard PC game control devices, They are very important for a entertainment or consumer computer.

The W83697HF provides Flash ROM interface. That can support up to 4M legacy flash ROM.

The W83697HF support hardware status monitoring for personal computers. It can be used to monitor several critical hardware parameters of the system, including power supply voltages, fan speeds, and temperatures, which are very important for a high-end computer system to work stably and properly. Moreover, W83697HF support the Smart Fan control system, including the "Thermal Cruise™" and "Speed Cruise™" functions. Smart Fan can make system more stable and user friendly.

FEATURES

General

- Meet LPC Spec. 1.01
- Support LDRQ#(LPC DMA), SERIRQ (serial IRQ)
- Include all the features of Winbond I/O W83877TF
- Integrate Hardware Monitor functions
- Compliant with Microsoft PC98/PC99 Hardware Design Guide
- Support DPM (Device Power Management), ACPI
- Programmable configuration settings
- Single 24 or 48 MHz clock input

FDC

- Compatible with IBM PC AT disk drive systems
- Variable write pre-compensation with track selectable capability
- Support vertical recording format
- DMA enable logic
- 16-byte data FIFOs
- Support floppy disk drives and tape drives
- Detects all overrun and underrun conditions
- Built-in address mark detection circuit to simplify the read electronics
- FDD anti-virus functions with software write protect and FDD write enable signal (write data signal was forced to be inactive)
- Support up to four 3.5-inch or 5.25-inch floppy disk drives
- Completely compatible with industry standard 82077
- 360K/720K/1.2M/1.44M/2.88M format; 250K, 300K, 500K, 1M, 2M bps data transfer rate
- Support **3-mode FDD, and its Win95/98 driver**

UART

- Two high-speed 16550 compatible UARTs with 16-byte send/receive FIFOs
- MIDI compatible
- Fully programmable serial-interface characteristics:
 - 5, 6, 7 or 8-bit characters
 - Even, odd or no parity bit generation/detection
 - 1, 1.5 or 2 stop bits generation
- Internal diagnostic capabilities:
 - Loop-back controls for communications link fault isolation
 - Break, parity, overrun, framing error simulation
- Programmable baud generator allows division of 1.8461 MHz and 24 MHz by 1 to ($2^{16}-1$)
- Maximum baud rate up to **921k bps** for 14.769 MHz and 1.5M bps for 24 MHz

Infrared

- Support IrDA version 1.0 SIR protocol with maximum baud rate up to 115.2K bps
- Support SHARP ASK-IR protocol with maximum baud rate up to 57,600 bps
- Support Consumer IR with Wake-Up function.

Parallel Port

- Compatible with IBM parallel port
- Support PS/2 compatible bi-directional parallel port
- Support Enhanced Parallel Port (EPP) – Compatible with IEEE 1284 specification
- Support Extended Capabilities Port (ECP) – Compatible with IEEE 1284 specification
- Extension FDD mode supports disk drive B; and Extension 2FDD mode supports disk drives A and B through parallel port
- Enhanced printer port back-drive current protection

Game Port

- Support two separate Joysticks
- Support every Joystick two axes (X,Y) and two buttons (S1,S2) controllers

MIDI Port

- The baud rate is 31.25 Kbaud
- 16-byte input FIFO
- 16-byte output FIFO



Flash ROM Interface

- Support up to 4M flash ROM

General Purpose I/O Ports

- 48 programmable general purpose I/O ports
- General purpose I/O ports can serve as simple I/O ports, watch dog timer output, power LED output, infrared I/O pins, suspend LED output, Beep output
- Functional in power down mode

Hardware Monitor Functions

- Smart fan control system, support "Thermal Cruise™" and "Speed Cruise™"
- 2 thermal inputs from optionally remote thermistors or 2N3904 transistors or Pentium™ I/III thermal diode output
- 6 positive voltage inputs (typical for +12V, -12V, +5V, -5V, +3.3V, Vcore)
- 2 intrinsic voltage monitoring (typical for Vbat, +5VSB)
- 2 fan speed monitoring inputs
- 2 fan speed control
- Build in Case open detection circuit
- WATCHDOG comparison of all monitored values
- Programmable hysteresis and setting points for all monitored items
- Over temperature indicate output
- Automatic Power On voltage detection Beep
- Issue SMI#, IRQ, OVT# to activate system protection
- Winbond Hardware Doctor™ Support
- Intel LDCM™ / Acer ADM™ compatible

Package

- 128-pin PQFP

PIN CONFIGURATION FOR 697HF

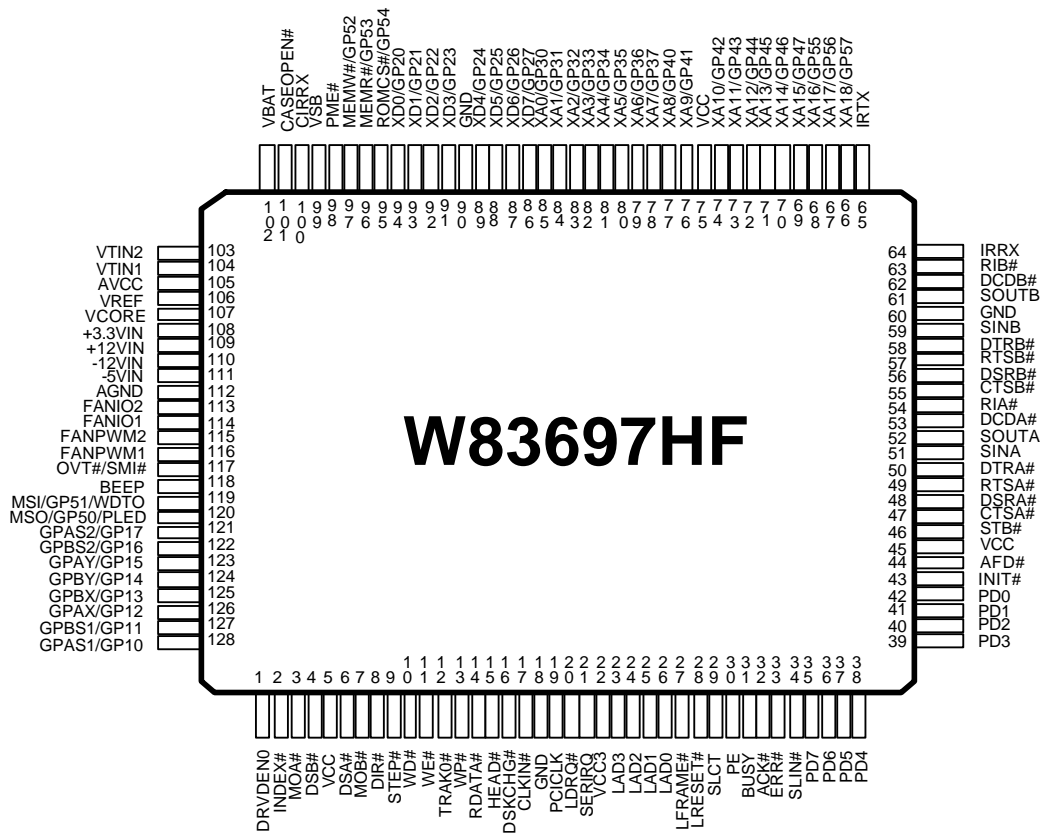

1. PIN DESCRIPTION

Note: Please refer to Section 13.2 DC CHARACTERISTICS for details.

I/O _{8t}	- TTL level bi-directional pin with 8 mA source-sink capability
I/O _{12t}	- TTL level bi-directional pin with 12 mA source-sink capability
I/O _{12tp3}	- 3.3V TTL level bi-directional pin with 12 mA source-sink capability
I/OD _{12t}	- TTL level bi-directional pin open drain output with 12 mA sink capability
I/O _{24t}	- TTL level bi-directional pin with 24 mA source-sink capability
OUT _{12t}	- TTL level output pin with 12 mA source-sink capability
OUT _{12tp3}	- 3.3V TTL level output pin with 12 mA source-sink capability
OD ₁₂	- Open-drain output pin with 12 mA sink capability
OD ₂₄	- Open-drain output pin with 24 mA sink capability
IN _{cs}	- CMOS level Schmitt-trigger input pin
IN _t	- TTL level input pin
IN _{td}	- TTL level input pin with internal pull down resistor
IN _{ts}	- TTL level Schmitt-trigger input pin
IN _{tsp3}	- 3.3V TTL level Schmitt-trigger input pin

1.1 LPC Interface

SYMBOL	PIN	I/O	FUNCTION
CLKIN	17	IN _t	System clock input. According to the input frequency 24MHz or 48MHz, it is selectable through register. Default is 24MHz input.
PME#	98	OD ₁₂	Generated PME event.
PCICLK	19	IN _{tsp3}	PCI clock input.
LDRQ#	20	O _{12tp3}	Encoded DMA Request signal.
SERIRQ	21	I/OD _{12t}	Serial IRQ input/Output.
LAD[3:0]	23-26	I/O _{12tp3}	These signal lines communicate address, control, and data information over the LPC bus between a host and a peripheral.
LFRAME#	27	IN _{tsp3}	Indicates start of a new cycle or termination of a broken cycle.
LRESET#	28	IN _{tsp3}	Reset signal. It can connect to PCIRST# signal on the host.

1.2 FDC Interface

SYMBOL	PIN	I/O	FUNCTION
DRVDE#	1	OD ₂₄	Drive Density Select bit 0.
INDEX#	2	IN _{CS}	This Schmitt-triggered input from the disk drive is active low when the head is positioned over the beginning of a track marked by an index hole. This input pin is pulled up internally by a 1 K Ω resistor. The resistor can be disabled by bit 7 of L0-CRF0 (FIPURDWN).
MOA#	3	OD ₂₄	Motor A On. When set to 0, this pin enables disk drive 0. This is an open drain output.
DSB#	4	OD ₂₄	Drive Select B. When set to 0, this pin enables disk drive B. This is an open drain output.
DSA#	6	OD ₂₄	Drive Select A. When set to 0, this pin enables disk drive A. This is an open drain output.
MOB#	7	OD ₂₄	Motor B On. When set to 0, this pin enables disk drive 1. This is an open drain output.
DIR#	8	OD ₂₄	Direction of the head step motor. An open drain output. Logic 1 = outward motion Logic 0 = inward motion
STEP#	9	OD ₂₄	Step output pulses. This active low open drain output produces a pulse to move the head to another track.
WD#	10	OD ₂₄	Write data. This logic low open drain writes pre-compensation serial data to the selected FDD. An open drain output.
WE#	11	OD ₂₄	Write enable. An open drain output.
TRAK0#	12	IN _{CS}	Track 0. This Schmitt-triggered input from the disk drive is active low when the head is positioned over the outermost track. This input pin is pulled up internally by a 1 K Ω resistor. The resistor can be disabled by bit 7 of L0-CRF0 (FIPURDWN).
WP#	13	IN _{CS}	Write protected. This active low Schmitt input from the disk drive indicates that the diskette is write-protected. This input pin is pulled up internally by a 1 K Ω resistor. The resistor can be disabled by bit 7 of L0-CRF0 (FIPURDWN).
RDATA#	14	IN _{CS}	The read data input signal from the FDD. This input pin is pulled up internally by a 1 K Ω resistor. The resistor can be disabled by bit 7 of L0-CRF0 (FIPURDWN).



1.2 FDC Interface, continued

SYMBOL	PIN	I/O	FUNCTION
HEAD#	15	OD ₂₄	Head select. This open drain output determines which disk drive head is active. Logic 1 = side 0 Logic 0 = side 1
DSKCHG#	16	IN _{CS}	Diskette change. This signal is active low at power on and whenever the diskette is removed. This input pin is pulled up internally by a 1 K Ω resistor. The resistor can be disabled by bit 7 of L0-CRF0 (FIPURDWN).

1.3 Multi-Mode Parallel Port

The following pins have alternate functions, which are controlled by CR28 and L3-CRF0.

SYMBOL	PIN	I/O	FUNCTION
SLCT	29	IN _t OD ₁₂ OD ₁₂	<p>PRINTER MODE: An active high input on this pin indicates that the printer is selected. This pin is pulled high internally. Refer to the description of the parallel port for definition of this pin in ECP and EPP mode.</p> <p>EXTENSION FDD MODE: WE2# This pin is for Extension FDD B; its function is the same as the WE# pin of FDC.</p> <p>EXTENSION 2FDD MODE: WE2# This pin is for Extension FDD A and B; its function is the same as the WE# pin of FDC.</p>
PE	30	IN _t OD ₁₂ OD ₁₂	<p>PRINTER MODE: An active high input on this pin indicates that the printer has detected the end of the paper. This pin is pulled high internally. Refer to the description of the parallel port for the definition of this pin in ECP and EPP mode.</p> <p>EXTENSION FDD MODE: WD2# This pin is for Extension FDD B; its function is the same as the WD# pin of FDC.</p> <p>EXTENSION 2FDD MODE: WD2# This pin is for Extension FDD A and B; its function is the same as the WD# pin of FDC.</p>

1.3 Multi-Mode Parallel Port, continued

SYMBOL	PIN	I/O	FUNCTION
BUSY	31	IN _t OD ₁₂ OD ₁₂	PRINTER MODE: An active high input indicates that the printer is not ready to receive data. This pin is pulled high internally. Refer to the description of the parallel port for definition of this pin in ECP and EPP mode. EXTENSION FDD MODE: MOB2# This pin is for Extension FDD B; its function is the same as the MOB# pin of FDC. EXTENSION 2FDD MODE: MOB2# This pin is for Extension FDD A and B; its function is the same as the MOB# pin of FDC.
ACK#	32	IN _t OD ₁₂ OD ₁₂	PRINTER MODE: ACK# An active low input on this pin indicates that the printer has received data and is ready to accept more data. This pin is pulled high internally. Refer to the description of the parallel port for the definition of this pin in ECP and EPP mode. EXTENSION FDD MODE: DSB2# This pin is for the Extension FDD B; its functions is the same as the DSB# pin of FDC. EXTENSION 2FDD MODE: DSB2# This pin is for Extension FDD A and B; its function is the same as the DSB# pin of FDC.
ERR#	33	IN _t OD ₁₂ OD ₁₂	PRINTER MODE: ERR# An active low input on this pin indicates that the printer has encountered an error condition. This pin is pulled high internally. Refer to the description of the parallel port for the definition of this pin in ECP and EPP mode. EXTENSION FDD MODE: HEAD2# This pin is for Extension FDD B; its function is the same as the HEAD#pin of FDC. EXTENSION 2FDD MODE: HEAD2# This pin is for Extension FDD A and B; its function is the same as the HEAD# pin of FDC.

1.3 Multi-Mode Parallel Port, continued

SYMBOL	PIN	I/O	FUNCTION
SLIN#	34	OD ₁₂	PRINTER MODE: SLIN# Output line for detection of printer selection. This pin is pulled high internally. Refer to the description of the parallel port for the definition of this pin in ECP and EPP mode.
		OD ₁₂	EXTENSION FDD MODE: STEP2# This pin is for Extension FDD B; its function is the same as the STEP# pin of FDC.
		OD ₁₂	EXTENSION 2FDD MODE: STEP2# This pin is for Extension FDD A and B; its function is the same as the STEP# pin of FDC.
INIT#	43	OD ₁₂	PRINTER MODE: INIT# Output line for the printer initialization. This pin is pulled high internally. Refer to the description of the parallel port for the definition of this pin in ECP and EPP mode.
		OD ₁₂	EXTENSION FDD MODE: DIR2# This pin is for Extension FDD B; its function is the same as the DIR# pin of FDC.
		OD ₁₂	EXTENSION 2FDD MODE: DIR2# This pin is for Extension FDD A and B; its function is the same as the DIR# pin of FDC.
AFD#	44	OD ₁₂	PRINTER MODE: AFD# An active low output from this pin causes the printer to auto feed a line after a line is printed. This pin is pulled high internally. Refer to the description of the parallel port for the definition of this pin in ECP and EPP mode.
		OD ₁₂	EXTENSION FDD MODE: DRVDEN0 This pin is for Extension FDD B; its function is the same as the DRVDEN0 pin of FDC.
		OD ₁₂	EXTENSION 2FDD MODE: DRVDEN0 This pin is for Extension FDD A and B; its function is the same as the DRVDEN0 pin of FDC.

1.3 Multi-Mode Parallel Port, continued

SYMBOL	PIN	I/O	FUNCTION
STB#	46	OD ₁₂ - -	<p>PRINTER MODE: STB#</p> <p>An active low output is used to latch the parallel data into the printer. This pin is pulled high internally. Refer to the description of the parallel port for the definition of this pin in ECP and EPP mode.</p> <p>EXTENSION FDD MODE: This pin is a tri-state output.</p> <p>EXTENSION 2FDD MODE: This pin is a tri-state output.</p>
PD0	42	I/O _{12t} IN _t IN _t	<p>PRINTER MODE: PD0</p> <p>Parallel port data bus bit 0. Refer to the description of the parallel port for the definition of this pin in ECP and EPP mode.</p> <p>EXTENSION FDD MODE: INDEX2#</p> <p>This pin is for Extension FDD B; its function is the same as the INDEX# pin of FDC. It is pulled high internally.</p> <p>EXTENSION 2FDD MODE: INDEX2#</p> <p>This pin is for Extension FDD A and B; its function is the same as the INDEX# pin of FDC. It is pulled high internally.</p>
PD1	41	I/O _{12t} IN _t IN _t	<p>PRINTER MODE: PD1</p> <p>Parallel port data bus bit 1. Refer to the description of the parallel port for the definition of this pin in ECP and EPP mode.</p> <p>EXTENSION FDD MODE: TRAK02#</p> <p>This pin is for Extension FDD B; its function is the same as the TRAK0# pin of FDC. It is pulled high internally.</p> <p>EXTENSION. 2FDD MODE: TRAK02#</p> <p>This pin is for Extension FDD A and B; its function is the same as the TRAK0# pin of FDC. It is pulled high internally.</p>
PD2	40	I/O _{12t} IN _t IN _t	<p>PRINTER MODE: PD2</p> <p>Parallel port data bus bit 2. Refer to the description of the parallel port for the definition of this pin in ECP and EPP mode.</p> <p>EXTENSION FDD MODE: WP2#</p> <p>This pin is for Extension FDD B; its function is the same as the WP# pin of FDC. It is pulled high internally.</p> <p>EXTENSION. 2FDD MODE: WP2#</p> <p>This pin is for Extension FDD A and B; its function is the same as the WP# pin of FDC. It is pulled high internally.</p>

1.3 Multi-Mode Parallel Port, continued

SYMBOL	PIN	I/O	FUNCTION
PD3	39	I/O _{12t} IN _t IN _t	<p>PRINTER MODE: PD3 Parallel port data bus bit 3. Refer to the description of the parallel port for the definition of this pin in ECP and EPP mode.</p> <p>EXTENSION FDD MODE: RDATA2# This pin is for Extension FDD B; its function is the same as the RDATA# pin of FDC. It is pulled high internally.</p> <p>EXTENSION 2FDD MODE: RDATA2# This pin is for Extension FDD A and B; its function is the same as the RDATA# pin of FDC. It is pulled high internally.</p>
PD4	38	I/O _{12t} IN _t IN _t	<p>PRINTER MODE: PD4 Parallel port data bus bit 4. Refer to the description of the parallel port for the definition of this pin in ECP and EPP mode.</p> <p>EXTENSION FDD MODE: DSKCHG2# This pin is for Extension FDD B; the function of this pin is the same as the DSKCHG# pin of FDC. It is pulled high internally.</p> <p>EXTENSION 2FDD MODE: DSKCHG2# This pin is for Extension FDD A and B; this function of this pin is the same as the DSKCHG# pin of FDC. It is pulled high internally.</p>
PD5	37	I/O _{12t} - -	<p>PRINTER MODE: PD5 Parallel port data bus bit 5. Refer to the description of the parallel port for the definition of this pin in ECP and EPP mode.</p> <p>EXTENSION FDD MODE: This pin is a tri-state output.</p> <p>EXTENSION 2FDD MODE: This pin is a tri-state output.</p>
PD6	36	I/OD _{12t} - OD ₁₂	<p>PRINTER MODE: PD6 Parallel port data bus bit 6. Refer to the description of the parallel port for the definition of this pin in ECP and EPP mode.</p> <p>EXTENSION FDD MODE: This pin is a tri-state output.</p> <p>EXTENSION. 2FDD MODE: MOA2# This pin is for Extension FDD A; its function is the same as the MOA# pin of FDC.</p>
PD7	35	I/OD _{12t} - OD ₁₂	<p>PRINTER MODE: PD7 Parallel port data bus bit 7. Refer to the description of the parallel port for the definition of this pin in ECP and EPP mode.</p> <p>EXTENSION FDD MODE: This pin is a tri-state output.</p> <p>EXTENSION 2FDD MODE: DSA2# This pin is for Extension FDD A; its function is the same as the DSA# pin of FDC.</p>

1.4 Serial Port Interface

SYMBOL	PIN	I/O	FUNCTION
CTSA# CTSB#	47 55	IN _t	Clear To Send. It is the modem control input. The function of these pins can be tested by reading bit 4 of the handshake status register.
DSRA# DSRB#	48 56	IN _t	Data Set Ready. An active low signal indicates the modem or data set is ready to establish a communication link and transfer data to the UART.
RTSA# HEFRAS	49	I/O _{8t}	UART A Request To Send. An active low signal informs the modem or data set that the controller is ready to send data. During power-on reset, this pin is pulled down internally and is defined as HEFRAS, which provides the power-on value for CR26 bit 6 (HEFRAS). A 4.7 k Ω is recommended if intends to pull up. (select 4EH as configuration I/O port's address)
RTSB#	57	I/O _{8t}	UART B Request To Send. An active low signal informs the modem or data set that the controller is ready to send data.
DTRA# PNPCSV#	50	I/O _{8t}	UART A Data Terminal Ready. An active low signal informs the modem or data set that the controller is ready to communicate. During power-on reset, this pin is pulled down internally and is defined as PNPCSV#, which provides the power-on value for CR24 bit 0 (PNPCSV#). A 4.7 k Ω is recommended if intends to pull up. (clear the default value of FDC, UARTs, and PRT)
DTRB#	58	I/O _{8t}	UART B Data Terminal Ready. An active low signal informs the modem or data set that controller is ready to communicate.
SINA SINB	51 59	IN _t	Serial Input. It is used to receive serial data through the communication link.
SOUTA PENROM#	52	I/O _{8t}	UART A Serial Output. It is used to transmit serial data out to the communication link. During power on reset , this pin is pulled down internally and is defined as PENROM#, which provides the power on value for CR24 bit 1. A 4.7k Ω is recommended if intends to pull up .
SOUTB PEN48	61	I/O _{8t}	UART B Serial Output. During power-on reset, this pin is pulled down internally and is defined as PEN48, which provides the power-on value for CR24 bit 6 (EN48). A 4.7 k Ω resistor is recommended if intends to pull up.
DCDA# DCDB#	53 62	IN _t	Data Carrier Detect. An active low signal indicates the modem or data set has detected a data carrier.
RIA# RIB#	54 63	IN _t	Ring Indicator. An active low signal indicates that a ring signal is being received from the modem or data set.



1.5 Infrared Port

SYMBOL	PIN	I/O	FUNCTION
IRRX	64	Ints	Alternate Function Input: Infrared Receiver input. General purpose I/O port 3 bit 6.
IRTX	65	OUT _{12t}	Alternate Function Output: Infrared Transmitter Output. General purpose I/O port 3 bit 7.
CIRRX#	100	IN _t	Consumer IR receiving input. This pin can Wake-Up system from S ₅ ^{cold} .

1.6 Fresh ROM Interface

SYMBOL	PIN	I/O	FUNCTION
XA18-XA16 GP57-GP55	66-68	I/O _{12t} I/OD _{12t}	Flash ROM interface Address[18:16] General purpose I/O port 5 bit7-5
XA15-XA10 GP47-GP42	69-74	I/O _{12t} I/OD _{12t}	Flash ROM interface Address[15:10] General purpose I/O port 4 bit7-2
XA9-XA8 GP41-GP40	76-77	I/O _{12t} I/OD _{12t}	Flash ROM interface Address[9:8] General purpose I/O port 4 bit1-0
XA7-XA0 GP37-GP30	78-85	O I/OD _{12t}	Flash ROM interface Address[7:0] General purpose I/O port 3 bit7-0
XD7-XD4 GP27-GP24	86-89	O I/OD _{12t}	Flash ROM interface Data Bus[7:4] General purpose I/O port 2 bit7-4
XD3-XD0 GP23-GP20	91-94	I/O _{12t} I/OD _{12t}	Flash ROM interface Data Bus [3:0] General purpose I/O port 2 bit3-0
ROMCS# GP54	95	I/O _{12t} I/OD _{12t}	Flash ROM interface Chip Slect General purpose I/O port 5 bit4
MEMR# GP53	96	I/O _{12t} I/OD _{12t}	Flash ROM interface Memory Read Enable General purpose I/O port 5 bit3
MEMW# GP52	97	I/O _{12t} I/OD _{12t}	Flash ROM interface Memory Write Enable General purpose I/O port 5 bit2

1.7 Hardware Monitor Interface

SYMBOL	PIN	I/O	FUNCTION
CASEOPEN#	101	IN _t	CASE OPEN. An active low signal from an external device when case is opened.
VBAT	102	Power	Battery Voltage Input
VTIN2	103	AIN	Temperature sensor 2 input. It is used for CPU temperature measurement.
VTIN1	104	AIN	Temperature sensor 1 input. It is used for system temperature measurement.
VREF	106	AOUT	Reference Voltage for temperature measurement.
VCORE	107	AIN	0V to 4.096V FSR Analog Inputs.
+3.3VIN	108	AIN	0V to 4.096V FSR Analog Inputs.
+12VIN	109	AIN	0V to 4.096V FSR Analog Inputs.
-12VIN	110	AIN	0V to 4.096V FSR Analog Inputs.
-5VIN	111	AIN	0V to 4.096V FSR Analog Inputs.
FANIO[2:1]	113- 114	I/O _{12ts}	0V to +5V amplitude fan tachometer input. Alternate Function: Fan on-off control output. These multifunctional pins can be programmable input or output.
FANPWM[2: 1]	115- 116	O ₁₂	Fan speed control. Use the Pulse Width Modulation (PWM) technique to control the Fan's RPM.
OVT# / SMI#	117	OD ₁₂	Over temperature Shutdown Output. It indicates the VTIN1 or VTIN2 is over temperature limit. System Management Interrupt.
BEEP	118	OD ₁₂	Beep function for hardware monitor. This pin is low after system reset.

1.8 Game Port & MIDI Port

SYMBOL	PIN	I/O	FUNCTION
MSI GP51 WDTO	119	INt I/OD ₁₂ OD _{24t}	MIDI serial data input . General purpose I/O port 5 bit 1. Alternate Function Output(Default) Power LED output, this signal is low after system reset.
MSO GP50 PLED	120	OUT _{12t} I/OD ₁₂ OD _{24t}	MIDI serial data output. General purpose I/O port 5 bit 0. Alternate Function : Watch dog timer output.
GPAS2 GP17	121	INcs I/OD ₁₂	Active-low, Joystick I switch input 2. This pin has an internal pull-up resistor. (Default) General purpose I/O port 1 bit 7.
GPBS2 GP16	122	INcs I/OD ₁₂	Active-low, Joystick II switch input 2. This pin has an internal pull-up resistor. (Default) General purpose I/O port 1 bit 6.
GPAY GP15	123	I/OD ₁₂ I/OD ₁₂	Joystick I timer pin. this pin connect to Y positioning variable resistors for the Josystick. (Default) General purpose I/O port 1 bit 5.
GPBY GP14	124	I/OD ₁₂ I/OD ₁₂	Joystick II timer pin. this pin connect to Y positioning variable resistors for the Josystick. (Default) General purpose I/O port 1 bit 4.
GPBX GP13	125	I/OD ₁₂ I/OD ₁₂	Joystick II timer pin. this pin connect to X positioning variable resistors for the Josystick. (Default) General purpose I/O port 1 bit 3.
GPAX GP12	126	I/OD ₁₂ I/OD ₁₂	Joystick I timer pin. this pin connect to X positioning variable resistors for the Josystick. (Default) General purpose I/O port 1 bit 2.
GPBS1 GP11	127	INcs I/OD ₁₂	Active-low, Joystick II switch input 1. This pin has an internal pull-up resistor. (Default) General purpose I/O port 1 bit 1.
GPAS1 GP10	128	INcs I/OD ₁₂	Active-low, Joystick I switch input 1. This pin has an internal pull-up resistor. (Default) General purpose I/O port 1 bit 0.

1.9 POWER PINS

SYMBOL	PIN	FUNCTION
VCC	5, 45, 75,	+5V power supply for the digital circuitry.
VSB	99	+5V stand-by power supply for the digital circuitry.
VCC3V	22	+3.3V power supply for driving 3V on host interface.
AVCC	105	Analog VCC input. Internally supplier to all analog circuitry.
AGND	112	Internally connected to all analog circuitry. The ground reference for all analog inputs..
GND	18, 60, 90,	Ground.

2. LPC (LOW PIN COUNT) INTERFACE

LPC interface is to replace ISA interface serving as a bus interface between host (chip-set) and peripheral (Winbond I/O). Data transfer on the LPC bus are serialized over a 4 bit bus. The general characteristics of the interface implemented in Winbond LPC I/O are:

- One control line, namely LFRAME#, which is used by the host to start or stop transfers. No peripherals drive this signal.
- The LAD[3:0] bus, which communicates information serially. The information conveyed are cycle type, cycle direction, chip selection, address, data, and wait states.
- MR (master reset) of Winbond ISA I/O is replaced with a active low reset signal, namely LRESET#, in Winbond LPC I/O.
- An additional 33 MHz PCI clock is needed in Winbond LPC I/O for synchronization.
- DMA requests are issued through LDRQ#.
- Interrupt requests are issued through SERIRQ.
- Power management events are issued through PME#.

Comparing to its ISA counterpart, LPC implementation saves up to 40 pin counts free for integrating more devices on a single chip.

The transition from ISA to LPC is transparent in terms of software which means no BIOS or device driver update is needed except chip-specific configuration.



3. FDC FUNCTIONAL DESCRIPTION

3.1 W83697HF FDC

The floppy disk controller of the W83697HF integrates all of the logic required for floppy disk control. The FDC implements a PC/AT or PS/2 solution. All programmable options default to compatible values. The FIFO provides better system performance in multi-master systems. The digital data separator supports up to 2 M bits/sec data rate.

The FDC includes the following blocks: AT interface, Precompensation, Data Rate Selection, Digital Data Separator, FIFO, and FDC Core.

3.1.1 AT interface

The interface consists of the standard asynchronous signals: RD#, WR#, A0-A3, IRQ, DMA control, and a data bus. The address lines select between the configuration registers, the FIFO and control/status registers. This interface can be switched between PC/AT, Model 30, or PS/2 normal modes. The PS/2 register sets are a superset of the registers found in a PC/AT.

3.1.2 FIFO (Data)

The FIFO is 16 bytes in size and has programmable threshold values. All command parameter information and disk data transfers go through the FIFO. Data transfers are governed by the RQM and DIO bits in the Main Status Register.

The FIFO defaults to disabled mode after any form of reset. This maintains PC/AT hardware compatibility. The default values can be changed through the CONFIGURE command. The advantage of the FIFO is that it allows the system a larger DMA latency without causing disk errors. The following tables give several examples of the delays with a FIFO. The data are based upon the following formula:

$$\text{THRESHOLD \#} \times (1/\text{DATA/RATE}) * 8 - 1.5 \mu\text{S} = \text{DELAY}$$

FIFO THRESHOLD	MAXIMUM DELAY TO SERVICING AT 500K BPS
	Data Rate
1 Byte	$1 \times 16 \mu\text{S} - 1.5 \mu\text{S} = 14.5 \mu\text{S}$
2 Byte	$2 \times 16 \mu\text{S} - 1.5 \mu\text{S} = 30.5 \mu\text{S}$
8 Byte	$8 \times 16 \mu\text{S} - 1.5 \mu\text{S} = 6.5 \mu\text{S}$
15 Byte	$15 \times 16 \mu\text{S} - 1.5 \mu\text{S} = 238.5 \mu\text{S}$
FIFO THRESHOLD	MAXIMUM DELAY TO SERVICING AT 1M BPS
	Data Rate
1 Byte	$1 \times 8 \mu\text{S} - 1.5 \mu\text{S} = 6.5 \mu\text{S}$
2 Byte	$2 \times 8 \mu\text{S} - 1.5 \mu\text{S} = 14.5 \mu\text{S}$
8 Byte	$8 \times 8 \mu\text{S} - 1.5 \mu\text{S} = 62.5 \mu\text{S}$
15 Byte	$15 \times 8 \mu\text{S} - 1.5 \mu\text{S} = 118.5 \mu\text{S}$



At the start of a command the FIFO is always disabled and command parameters must be sent based upon the RQM and DIO bit settings in the main status register. When the FDC enters the command execution phase, it clears the FIFO of any data to ensure that invalid data are not transferred.

An overrun and underrun will terminate the current command and the data transfer. Disk writes will complete the current sector by generating a 00 pattern and valid CRC. Reads require the host to remove the remaining data so that the result phase may be entered.

DMA transfers are enabled with the SPECIFY command and are initiated by the FDC by activating the DRQ pin during a data transfer command. The FIFO is enabled directly by asserting DACK# and addresses need not be valid.

Note that if the DMA controller is programmed to function in verify mode a pseudo read is performed by the FDC based only on DACK#. This mode is only available when the FDC has been configured into byte mode (FIFO disabled) and is programmed to do a read. With the FIFO enabled the above operation is performed by using the new VERIFY command. No DMA operation is needed. ; @

3.1.3 Data Separator

The function of the data separator is to lock onto the incoming serial read data. When a lock is achieved the serial front end logic of the chip is provided with a clock which is synchronized to the read data. The synchronized clock, called the Data Window, is used to internally sample the serial data portion of the bit cell, and the alternate state samples the clock portion. Serial to parallel conversion logic separates the read data into clock and data bytes.

The Digital Data Separator (DDS) has three parts: control logic, error adjustment, and speed tracking. The DDS circuit cycles once every 12 clock cycles ideally. Any data pulse input will be synchronized and then adjusted by immediate error adjustment. The control logic will generate RDD and RWD for every pulse input. During any cycle where no data pulse is present, the DDS cycles are based on speed. A digital integrator is used to keep track of the speed changes in the input data stream.

3.1.4 Write Precompensation

The write precompensation logic is used to minimize bit shifts in the RDDATA stream from the disk drive. Shifting of bits is a known phenomenon in magnetic media and is dependent on the disk media and the floppy drive.

The FDC monitors the bit stream that is being sent to the drive. The data patterns that require precompensation are well known. Depending upon the pattern, the bit is shifted either early or late relative to the surrounding bits.



3.1.5 Perpendicular Recording Mode

The FDC is also capable of interfacing directly to perpendicular recording floppy drives. Perpendicular recording differs from the traditional longitudinal method in that the magnetic bits are oriented vertically. This scheme packs more data bits into the same area.

FDCs with perpendicular recording drives can read standard 3.5" floppy disks and can read and write perpendicular media. Some manufacturers offer drives that can read and write standard and perpendicular media in a perpendicular media drive.

A single command puts the FDC into perpendicular mode. All other commands operate as they normally do. The perpendicular mode requires a 1 Mbps data rate for the FDC. At this data rate the FIFO eases the host interface bottleneck due to the speed of data transfer to or from the disk.

3.1.6 FDC Core

The W83697HF FDC is capable of performing twenty commands. Each command is initiated by a multi-byte transfer from the microprocessor. The result can also be a multi-byte transfer back to the microprocessor. Each command consists of three phases: command, execution, and result.

Command

The microprocessor issues all required information to the controller to perform a specific operation.

Execution

The controller performs the specified operation.

Result

After the operation is completed, status information and other housekeeping information is provided to the microprocessor.

3.1.7 FDC Commands

Command Symbol Descriptions:

C:	Cylinder number 0 - 256
D:	Data Pattern
DIR:	Step Direction
	DIR = 0, step out
	DIR = 1, step in
DS0:	Disk Drive Select 0
DS1:	Disk Drive Select 1
DTL:	Data Length
EC:	Enable Count
EOT:	End of Track
EFIFO:	Enable FIFO
EIS:	Enable Implied Seek



EOT:	End of track
FIFOTHR:	FIFO Threshold
GAP:	Gap length selection
GPL:	Gap Length
H:	Head number
HDS:	Head number select
HLT:	Head Load Time
HUT:	Head Unload Time
LOCK:	Lock EFIFO, FIFOTHR, PTRTRK bits prevent affected by software reset
MFM:	MFM or FM Mode
MT:	Multitrack
N:	The number of data bytes written in a sector
NCN:	New Cylinder Number
ND:	Non-DMA Mode
OW:	Overwritten
PCN:	Present Cylinder Number
POLL:	Polling Disable
PRETRK:	Precompensation Start Track Number
R:	Record
RCN:	Relative Cylinder Number
R/W:	Read/Write
SC:	Sector/per cylinder
SK:	Skip deleted data address mark
SRT:	Step Rate Time
ST0:	Status Register 0
ST1:	Status Register 1
ST2:	Status Register 2
ST3:	Status Register 3
WG:	Write gate alters timing of WE



(1) Read Data

PHASE	R/W	D7	D6	D5	D4	D3	D2	D1	D0	REMARKS	
Command	W	MT	MFM	SK	0	0	1	1	0	Command codes Sector ID information prior to command execution	
	W	0	0	0	0	0	HDS	DS1	DS0		
	W										----- C -----
	W										----- H -----
	W										----- R -----
	W										----- N -----
	W										----- EOT -----
	W										----- GPL -----
	W										----- DTL -----
Execution										Data transfer between the FDD and system	
Result	R									Status information after command execution Sector ID information after command execution	
	R										----- ST0 -----
	R										----- ST1 -----
	R										----- ST2 -----
	R										----- C -----
	R										----- H -----
	R										----- R -----
R									----- N -----		



(2) Read Deleted Data

PHASE	R/W	D7	D6	D5	D4	D3	D2	D1	D0	REMARKS	
Command	W	MT	MFM	SK	0	1	1	0	0	Command codes Sector ID information prior to command execution	
	W	0	0	0	0	0	HDS	DS1	DS0		
	W										----- C -----
	W										----- H -----
	W										----- R -----
	W										----- N -----
	W										----- EOT -----
	W										----- GPL -----
	W										----- DTL -----
Execution										Data transfer between the FDD and system	
Result	R									Status information after command execution Sector ID information after command execution	
	R										----- ST0 -----
	R										----- ST1 -----
	R										----- ST2 -----
	R										----- C -----
	R										----- H -----
	R										----- R -----
R									----- N -----		



(3) Read A Track

PHASE	R/W	D7	D6	D5	D4	D3	D2	D1	D0	REMARKS	
Command	W	0	MFM	0	0	0	0	1	0	Command codes Sector ID information prior to command execution	
	W	0	0	0	0	0	HDS	DS1	DS0		
	W										----- C -----
	W										----- H -----
	W										----- R -----
	W										----- N -----
	W										----- EOT -----
	W										----- GPL -----
	W										----- DTL -----
Execution										Data transfer between the FDD and system; FDD reads contents of all cylinders from index hole to EOT	
Result	R									----- ST0 -----	Status information after command execution Sector ID information after command execution
	R									----- ST1 -----	
	R									----- ST2 -----	
	R									----- C -----	
	R									----- H -----	
	R									----- R -----	
	R									----- N -----	



(4) Read ID

PHASE	R/W	D7	D6	D5	D4	D3	D2	D1	D0	REMARKS
Command	W	0	MFM	0	0	1	0	1	0	Command codes
	W	0	0	0	0	0	HDS	DS1	DS0	
Execution										The first correct ID information on the cylinder is stored in Data Register
Result	R									Status information after command execution
	R									
	R									
	R									Disk status after the command has been completed
	R									
	R									
	R									
R										



(5) Verify

PHASE	R/W	D7	D6	D5	D4	D3	D2	D1	D0	REMARKS	
Command	W	MT	MFM	SK	1	0	1	1	0	Command codes Sector ID information prior to command execution	
	W	EC	0	0	0	0	HDS	DS1	DS0		
	W										----- C -----
	W										----- H -----
	W										----- R -----
	W										----- N -----
	W										----- EOT -----
	W										----- GPL ----- ----- DTL/SC -----
Execution										No data transfer takes place	
Result	R									----- ST0 -----	Status information after command execution
	R									----- ST1 -----	
	R									----- ST2 -----	
	R									----- C -----	Sector ID information after command execution
	R									----- H -----	
	R									----- R -----	
	R									----- N -----	



(6) Version

PHASE	R/W	D7	D6	D5	D4	D3	D2	D1	D0	REMARKS
Command	W	0	0	0	1	0	0	0	0	Command code
Result	R	1	0	0	1	0	0	0	0	Enhanced controller

(7) Write Data

PHASE	R/W	D7	D6	D5	D4	D3	D2	D1	D0	REMARKS	
Command	W	MT	MFM	0	0	0	1	0	1	Command codes	
	W	0	0	0	0	0	HDS	DS1	DS0		
	W										Sector ID information prior to Command execution
	W										
	W										
	W										
	W										
	W										
	W										
Execution										Data transfer between the FDD and system	
Result	R									Status information after Command execution	
	R										
	R										
	R										Sector ID information after Command execution
	R										
	R										
	R										



(8) Write Deleted Data

PHASE	R/W	D7	D6	D5	D4	D3	D2	D1	D0	REMARKS	
Command	W	MT	MFM	0	0	1	0	0	1	Command codes Sector ID information prior to command execution	
	W	0	0	0	0	0	HDS	DS1	DS0		
	W										----- C -----
	W										----- H -----
	W										----- R -----
	W										----- N -----
	W										----- EOT -----
	W										----- GPL -----
	W										----- DTL -----
Execution										Data transfer between the FDD and system	
Result	R									Status information after command execution Sector ID information after command execution	
	R										----- ST0 -----
	R										----- ST1 -----
	R										----- ST2 -----
	R										----- C -----
	R										----- H -----
	R										----- R -----
R									----- N -----		



(9) Format A Track

PHASE	R/W	D7	D6	D5	D4	D3	D2	D1	D0	REMARKS	
Command	W	0	MFM	0	0	1	1	0	1	Command codes	
	W	0	0	0	0	0	HDS	DS1	DS0		
	W	----- N -----									Bytes/Sector
	W	----- SC -----									Sectors/Cylinder
	W	----- GPL -----									Gap 3
W	----- D -----								Filler Byte		
Execution for Each Sector Repeat:	W	----- C -----								Input Sector Parameters	
	W	----- H -----									
	W	----- R -----									
	W	----- N -----									
Result	R	----- ST0 -----								Status information after command execution	
	R	----- ST1 -----									
	R	----- ST2 -----									
	R	----- Undefined -----									
	R	----- Undefined -----									
	R	----- Undefined -----									
R	----- Undefined -----										

(10) Recalibrate

PHASE	R/W	D7	D6	D5	D4	D3	D2	D1	D0	REMARKS
Command	W	0	0	0	0	0	1	1	1	Command codes
	W	0	0	0	0	0	0	DS1	DS0	
Execution										Head retracted to Track 0 Interrupt



(11) Sense Interrupt Status

PHASE	R/W	D7	D6	D5	D4	D3	D2	D1	D0	REMARKS
Command	W	0	0	0	0	1	0	0	0	Command code
Result	R	----- ST0 -----								
	R	----- PCN -----								

(12) Specify

PHASE	R/W	D7	D6	D5	D4	D3	D2	D1	D0	REMARKS
Command	W	0	0	0	0	0	0	1	1	Command codes
	W	-----SRT ----- ----- HUT -----								
	W	----- HLT ----- ND								

(13) Seek

PHASE	R/W	D7	D6	D5	D4	D3	D2	D1	D0	REMARKS
Command	W	0	0	0	0	1	1	1	1	Command codes
	W	0	0	0	0	0	HDS	DS1	DS0	
	W	----- NCN -----								
Execution	R									Head positioned over proper cylinder on diskette

(14) Configure

PHASE	R/W	D7	D6	D5	D4	D3	D2	D1	D0	REMARKS	
Command	W	0	0	0	1	0	0	1	1	Configure information	
	W	0	0	0	0	0	0	0	0		
	W	0	EIS EFIFO POLL ----- FIFOTHR ----								
	W	-----PRETRK -----									
Execution										Internal registers written	



(15) Relative Seek

PHASE	R/W	D7	D6	D5	D4	D3	D2	D1	D0	REMARKS
Command	W	1	DIR	0	0	1	1	1	1	Command codes
	W	0	0	0	0	0	HDS	DS1	DS0	
	W	----- RCN -----								

(16) Dumpreg

PHASE	R/W	D7	D6	D5	D4	D3	D2	D1	D0	REMARKS
Command	W	0	0	0	0	1	1	1	0	Registers placed in FIFO
Result	R	----- PCN-Drive 0-----								
	R	----- PCN-Drive 1 -----								
	R	----- PCN-Drive 2-----								
	R	----- PCN-Drive 3 -----								
	R	-----SRT -----				----- HUT -----				
	R	----- HLT -----							ND	
	R	----- SC/EOT -----								
	R	LOCK	0	D3	D2	D1	D0	GAP	WG	
	R	0	EIS EFIFO POLL			---- FIFOTHR -----				
	R	-----PRETRK -----								

(17) Perpendicular Mode

PHASE	R/W	D7	D6	D5	D4	D3	D2	D1	D0	REMARKS
Command	W	0	0	0	1	0	0	1	0	Command Code
	W	OW	0	D3	D2	D1	D0	GAP	WG	

(18) Lock

PHASE	R/W	D7	D6	D5	D4	D3	D2	D1	D0	REMARKS
Command	W	LOCK	0	0	1	0	1	0	0	Command Code
Result	R	0	0	0	LOCK	0	0	0	0	



(19) Sense Drive Status

PHASE	R/W	D7	D6	D5	D4	D3	D2	D1	D0	REMARKS
Command	W	0	0	0	0	0	1	0	0	Command Code
	W	0	0	0	0	0	HDS	DS1	DS0	
Result	R	----- ST3 -----								Status information about disk drive

(20) Invalid

PHASE	R/W	D7	D6	D5	D4	D3	D2	D1	D0	REMARKS
Command	W	----- Invalid Codes -----								Invalid codes (no operation- FDC goes to standby state) ST0 = 80H
Result	R	----- ST0 -----								



3.2 Register Descriptions

There are several status, data, and control registers in W83697HF. These registers are defined below:

ADDRESS OFFSET	REGISTER	
	READ	WRITE
base address + 0	SA REGISTER	
base address + 1	SB REGISTER	
base address + 2		DO REGISTER
base address + 3	TD REGISTER	TD REGISTER
base address + 4	MS REGISTER	DR REGISTER
base address + 5	DT (FIFO) REGISTER	DT (FIFO) REGISTER
base address + 7	DI REGISTER	CC REGISTER

3.2.1 Status Register A (SA Register) (Read base address + 0)

This register is used to monitor several disk interface pins in PS/2 and Model 30 modes. In PS/2 mode, the bit definitions for this register are as follows:

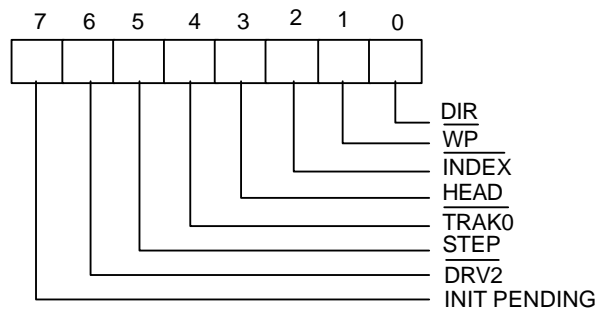

INIT PENDING (Bit 7):

This bit indicates the value of the floppy disk interrupt output.

DRV2# (Bit 6):

- 0 A second drive has been installed
- 1 A second drive has not been installed

STEP (Bit 5):

This bit indicates the complement of STEP# output.

TRAK0# (Bit 4):

This bit indicates the value of TRAK0# input.



HEAD (Bit 3):

This bit indicates the complement of HEAD# output.

- 0 side 0
- 1 side 1

INDEX# (Bit 2):

This bit indicates the value of INDEX# output.

WP# (Bit 1):

- 0 disk is write-protected
- 1 disk is not write-protected

DIR (Bit 0)

This bit indicates the direction of head movement.

- 0 outward direction
- 1 inward direction

In PS/2 Model 30 mode, the bit definitions for this register are as follows:

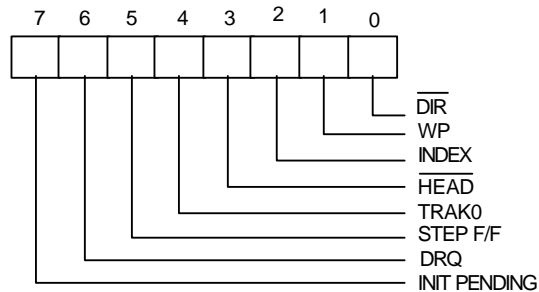

INIT PENDING (Bit 7):

This bit indicates the value of the floppy disk interrupt output.

DRQ (Bit 6):

This bit indicates the value of DRQ output pin.

STEP F/F (Bit 5):

This bit indicates the complement of latched STEP# output.

TRAK0 (Bit 4):

This bit indicates the complement of TRAK0# input.



HEAD# (Bit 3):

This bit indicates the value of HEAD# output.

- 0 side 1
- 1 side 0

INDEX (Bit 2):

This bit indicates the complement of INDEX# output.

WP (Bit 1):

- 0 disk is not write-protected
- 1 disk is write-protected

DIR# (Bit 0)

This bit indicates the direction of head movement.

- 0 inward direction
- 1 outward direction

3.2.2 Status Register B (SB Register) (Read base address + 1)

This register is used to monitor several disk interface pins in PS/2 and Model 30 modes. In PS/2 mode, the bit definitions for this register are as follows:

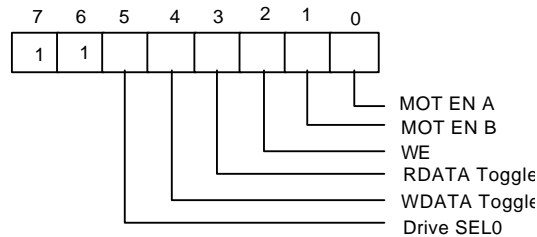

Drive SEL0 (Bit 5):

This bit indicates the status of DO REGISTER bit 0 (drive select bit 0).

WDATA Toggle (Bit 4):

This bit changes state at every rising edge of the WD# output pin.

RDATA Toggle (Bit 3):

This bit changes state at every rising edge of the RDATA# output pin.

WE (Bit 2):

This bit indicates the complement of the WE# output pin.



MOT EN B (Bit 1)

This bit indicates the complement of the MOB# output pin.

MOT EN A (Bit 0)

This bit indicates the complement of the MOA# output pin.

In PS/2 Model 30 mode, the bit definitions for this register are as follows:

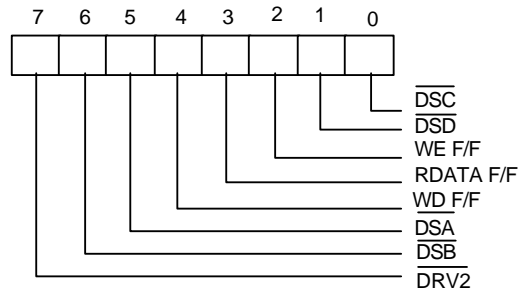

DRV2# (Bit 7):

- 0 A second drive has been installed
- 1 A second drive has not been installed

DSB# (Bit 6):

This bit indicates the status of DSB# output pin.

DSA# (Bit 5):

This bit indicates the status of DSA# output pin.

WD F/F (Bit 4):

This bit indicates the complement of the latched WD# output pin at every rising edge of the WD# output pin.

RDATA F/F (Bit 3):

This bit indicates the complement of the latched RDATA# output pin .

WE F/F (Bit 2):

This bit indicates the complement of latched WE# output pin.

DSD# (Bit 1):

- 0 Drive D has been selected
- 1 Drive D has not been selected

DSC# (Bit 0):

- 0 Drive C has been selected
- 1 Drive C has not been selected



3.2.3 Digital Output Register (DO Register) (Write base address + 2)

The Digital Output Register is a write-only register controlling drive motors, drive selection, DRQ/IRQ enable, and FDC resetting. All the bits in this register are cleared by the MR pin. The bit definitions are as follows:

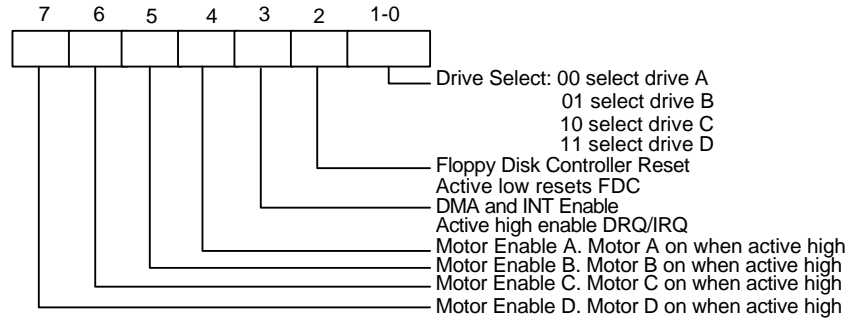

3.2.4 Tape Drive Register (TD Register) (Read base address + 3)

This register is used to assign a particular drive number to the tape drive support mode of the data separator. This register also holds the media ID, drive type, and floppy boot drive information of the floppy disk drive. In normal floppy mode, this register includes only bit 0 and 1. The bit definitions are as follows:

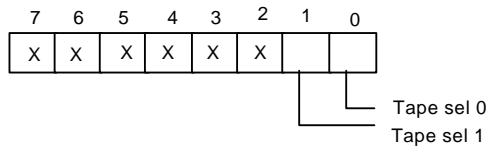

If three mode FDD function is enabled (EN3MODE = 1 in CR9), the bit definitions are as follows:

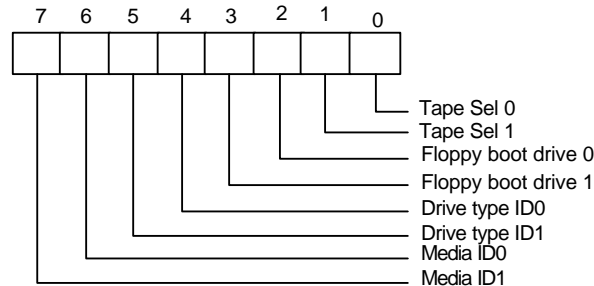



Media ID1 Media ID0 (Bit 7, 6):

These two bits are read only. These two bits reflect the value of CR8 bit 3, 2.

Drive type ID1 Drive type ID0 (Bit 5, 4):

These two bits reflect two of the bits of CR7. Which two bits are reflected depends on the last drive selected in the DO REGISTER.

Floppy Boot drive 1, 0 (Bit 3, 2):

These two bits reflect the value of CR8 bit 1, 0.

Tape Sel 1, Tape Sel 0 (Bit 1, 0):

These two bits assign a logical drive number to the tape drive. Drive 0 is not available as a tape drive and is reserved as the floppy disk boot drive.

TAPE SEL 1	TAPE SEL 0	DRIVE SELECTED
0	0	None
0	1	1
1	0	2
1	1	3

3.2.5 Main Status Register (MS Register) (Read base address + 4)

The Main Status Register is used to control the flow of data between the microprocessor and the controller. The bit definitions for this register are as follows:

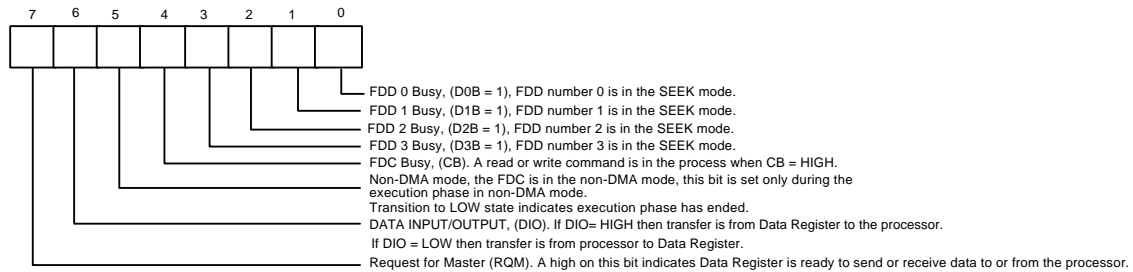



3.2.6 Data Rate Register (DR Register) (Write base address + 4)

The Data Rate Register is used to set the transfer rate and write precompensation. The data rate of the FDC is programmed by the CC REGISTER for PC-AT and PS/2 Model 30 and PS/2 mode, and not by the DR REGISTER. The real data rate is determined by the most recent write to either of the DR REGISTER or CC REGISTER.

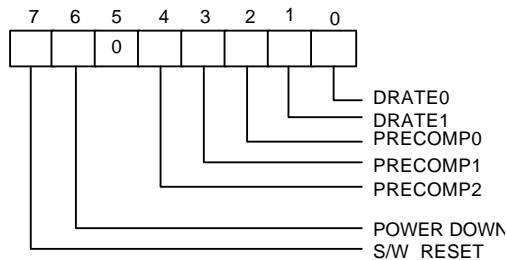

S/W RESET (Bit 7):

This bit is the software reset bit.

POWER-DOWN (Bit 6):

- 0 FDC in normal mode
- 1 FDC in power-down mode

PRECOMP2 PRECOMP1 PRECOMP0 (Bit 4, 3, 2):

These three bits select the value of write precompensation. The following tables show the precompensation values for the combination of these bits.

PRECOMP			PRECOMPENSATION DELAY	
2	1	0	250K - 1 Mbps	2 Mbps Tape drive
0	0	0	Default Delays	Default Delays
0	0	1	41.67 nS	20.8 nS
0	1	0	83.34 nS	41.17 nS
0	1	1	125.00 nS	62.5nS
1	0	0	166.67 nS	83.3 nS
1	0	1	208.33 nS	104.2 nS
1	1	0	250.00 nS	125.00 nS
1	1	1	0.00 nS (disabled)	0.00 nS (disabled)

DATA RATE	DEFAULT PRECOMPENSATION DELAYS
250 KB/S	125 nS
300 KB/S	125 nS
500 KB/S	125 nS
1 MB/S	41.67nS
2 MB/S	20.8 nS

DRATE1 DRATE0 (Bit 1, 0):

These two bits select the data rate of the FDC and reduced write current control.

- 00 500 KB/S (MFM), 250 KB/S (FM), $\overline{RWC} = 1$
- 01 300 KB/S (MFM), 150 KB/S (FM), $\overline{RWC} = 0$
- 10 250 KB/S (MFM), 125 KB/S (FM), $\overline{RWC} = 0$
- 11 1 MB/S (MFM), Illegal (FM), $\overline{RWC} = 1$

The 2 MB/S data rate for Tape drive is only supported by setting 01 to DRATE1 and DRATE0 bits, as well as setting 10 to DRT1 and DRT0 bits which are two of the Configure Register CRF4 or CRF5 bits in logic device 0. Please refer to the function description of CRF4 or CRF5 and data rate table for individual data rates setting.

3.2.7 FIFO Register (R/W base address + 5)

The Data Register consists of four status registers in a stack with only one register presented to the data bus at a time. This register stores data, commands, and parameters and provides diskette-drive status information. Data bytes are passed through the data register to program or obtain results after a command. In the W83697HF, this register defaults to FIFO disabled mode after reset. The FIFO can change its value and enable its operation through the CONFIGURE command.

Status Register 0 (ST0)

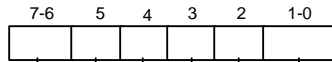

US1, US0 Drive Select:

- 00 Drive A selected
- 01 Drive B selected
- 10 Drive C selected
- 11 Drive D selected

HD Head address:

- 1 Head selected
- 0 Head selected

NR Not Ready:

- 1 Drive is not ready
- 0 Drive is ready

EC Equipment Check:

- 1 When a fault signal is received from the FDD or the track
- 0 signal fails to occur after 77 step pulses

SE Seek end:

- 1 seek end
- 0 seek error

IC Interrupt Code:

- 00 Normal termination of command
- 01 Abnormal termination of command
- 10 Invalid command issue
- 11 Abnormal termination because the ready signal from FDD changed state during command execution

Status Register 1 (ST1)

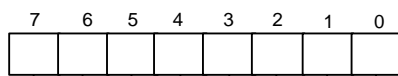

Missing Address Mark. 1 When the FDC cannot detect the data address mark or the data address mark has been deleted.

NW (Not Writable). 1 If a write Protect signal is detected from the diskette drive during execution of write data.

ND (No DATA). 1 If specified sector cannot be found during execution of a read, write or verify data.

Not used. This bit is always 0.

OR (Over Run). 1 If the FDC is not serviced by the host system within a certain time interval during data transfer.

DE (data Error). 1 When the FDC detects a CRC error in either the ID field or the data field.

Not used. This bit is always 0.

EN (End of track). 1 When the FDC tries to access a sector beyond the final sector of a cylinder.



Status Register 2 (ST2)

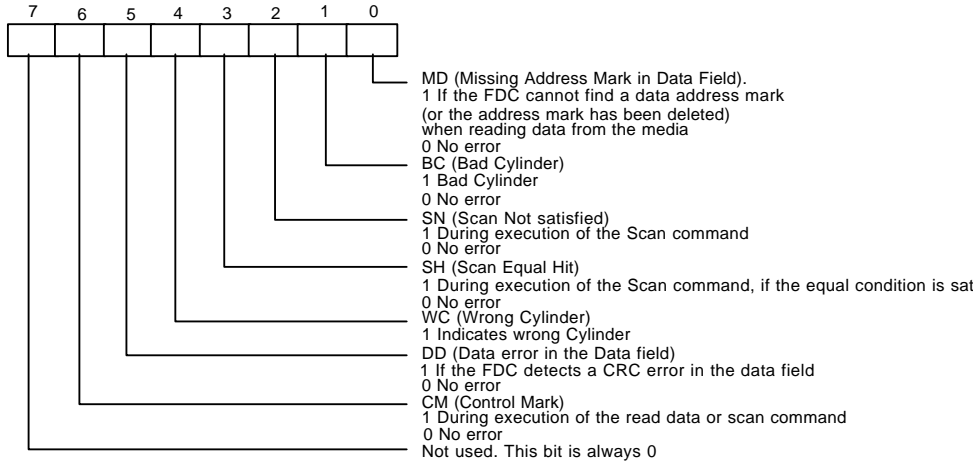

Status Register 3 (ST3)

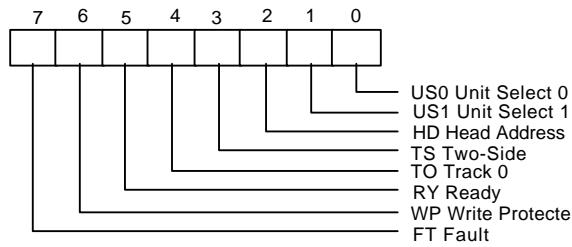



3.2.8 Digital Input Register (DI Register) (Read base address + 7)

The Digital Input Register is an 8-bit read-only register used for diagnostic purposes. In a PC/XT or AT only Bit 7 is checked by the BIOS. When the register is read, Bit 7 shows the complement of DSKCHG#, while other bits of the data bus remain in tri-state. Bit definitions are as follows:

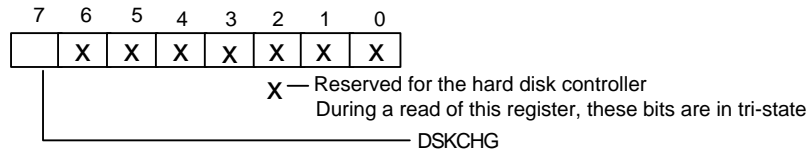

In the PS/2 mode, the bit definitions are as follows:

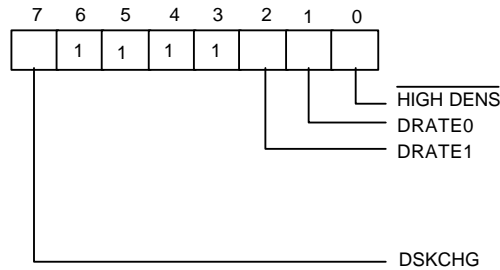

DSKCHG (Bit 7):

This bit indicates the complement of the DSKCHG# input.

Bit 63: These bits are always a logic 1 during a read.

DRATE1 DRATE0 (Bit 2, 1):

These two bits select the data rate of the FDC. Refer to the DR register bits 1 and 0 for the settings corresponding to the individual data rates.

HIGH DENS# (Bit 0):

- 0 500 KB/S or 1 MB/S data rate (high density FDD)
- 1 250 KB/S or 300 KB/S data rate

In the PS/2 Model 30 mode, the bit definitions are as follows:

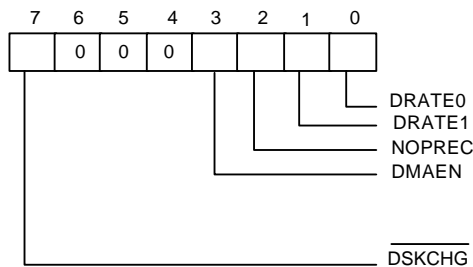



DSKCHG (Bit 7):

This bit indicates the status of DSKCHG# input.

Bit 64: These bits are always a logic 1 during a read.

DMAEN (Bit 3):

This bit indicates the value of DO REGISTER bit 3.

NOPREC (Bit 2):

This bit indicates the value of CC REGISTER NOPREC bit.

DRATE1 DRATE0 (Bit 1, 0):

These two bits select the data rate of the FDC.

3.2.9 Configuration Control Register (CC Register) (Write base address + 7)

This register is used to control the data rate. In the PC/AT and PS/2 mode, the bit definitions are as follows:

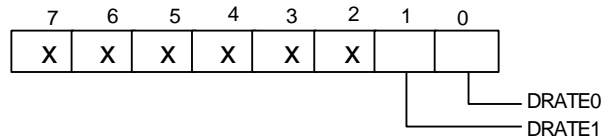

X: Reserved

Bit 7-2: Reserved. These bits should be set to 0.

DRATE1 DRATE0 (Bit 1, 0):

These two bits select the data rate of the FDC.

In the PS/2 Model 30 mode, the bit definitions are as follows:

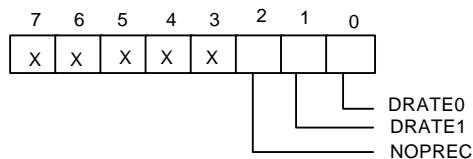

X: Reserved

Bit 7-3: Reserved. These bits should be set to 0.

NOPREC (Bit 2):

This bit indicates no precompensation. It has no function and can be set by software.

DRATE1 DRATE0 (Bit 1, 0):

These two bits select the data rate of the FDC.

4. UART PORT

4.1 Universal Asynchronous Receiver/Transmitter (UART A, UART B)

The UARTs are used to convert parallel data into serial format on the transmit side and convert serial data to parallel format on the receiver side. The serial format, in order of transmission and reception, is a start bit, followed by five to eight data bits, a parity bit (if programmed) and one, one and half (five-bit format only) or two stop bits. The UARTs are capable of handling divisors of 1 to 65535 and producing a 16x clock for driving the internal transmitter logic. Provisions are also included to use this 16x clock to drive the receiver logic. The UARTs also support the MIDI data rate. Furthermore, the UARTs also include complete modem control capability and a processor interrupt system that may be software trailed to the computing time required to handle the communication link. The UARTs have a FIFO mode to reduce the number of interrupts presented to the CPU. In each UART, there are 16-byte FIFOs for both receive and transmit mode.

4.2 Register Address

4.2.1 UART Control Register (UCR) (Read/Write)

The UART Control Register controls and defines the protocol for asynchronous data communications, including data length, stop bit, parity, and baud rate selection.

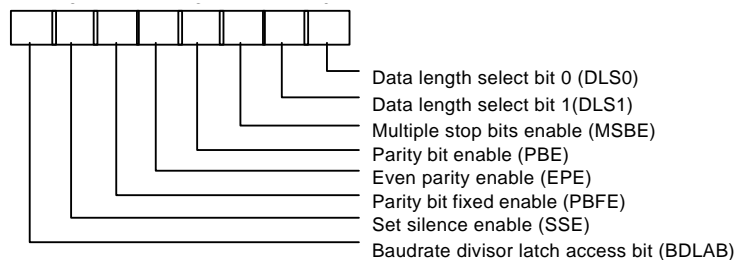

Bit 7: BDLAB. When this bit is set to a logical 1, designers can access the divisor (in 16-bit binary format) from the divisor latches of the baudrate generator during a read or write operation. When this bit is reset, the Receiver Buffer Register, the Transmitter Buffer Register, or the Interrupt Control Register can be accessed.

Bit 6: SSE. A logical 1 forces the Serial Output (SOUT) to a silent state (a logical 0). Only IRTX is affected by this bit; the transmitter is not affected.

Bit 5: PBFE. When PBE and PBFE of UCR are both set to a logical 1,

- (1) if EPE is logical 1, the parity bit is fixed as logical 0 to transmit and check.
- (2) if EPE is logical 0, the parity bit is fixed as logical 1 to transmit and check.



TABLE 4-1 UART Register Bit Map

Register Address Base		Bit Number								
			0	1	2	3	4	5	6	7
+ 0 BDLAB = 0	Receiver Buffer Register (Read Only)	RBR	RX Data Bit 0	RX Data Bit 1	RX Data Bit 2	RX Data Bit 3	RX Data Bit 4	RX Data Bit 5	RX Data Bit 6	RX Data Bit 7
+ 0 BDLAB = 0	Transmitter Buffer Register (Write Only)	TBR	TX Data Bit 0	TX Data Bit 1	TX Data Bit 2	TX Data Bit 3	TX Data Bit 4	TX Data Bit 5	TX Data Bit 6	TX Data Bit 7
+ 1 BDLAB = 0	Interrupt Control Register	ICR	RBR Data Ready Interrupt Enable (ERDRI)	TBR Empty Interrupt Enable (ETBREI)	USR Interrupt Enable (EUSRI)	HSR Interrupt Enable (EHSRI)	0	0	0	0
+ 2	Interrupt Status Register (Read Only)	ISR	"0" if Interrupt Pending	Interrupt Status Bit (0)	Interrupt Status Bit (1)	Interrupt Status Bit (2)**	0	0	FIFOs Enabled **	FIFOs Enabled **
+ 2	UART FIFO Control Register (Write Only)	UFR	FIFO Enable	RCVR FIFO Reset	XMIT FIFO Reset	DMA Mode Select	Reserved	Reversed	RX Interrupt Active Level (LSB)	RX Interrupt Active Level (MSB)
+ 3	UART Control Register	UCR	Data Length Select Bit 0 (DLS0)	Data Length Select Bit 1 (DLS1)	Multiple Stop Bits Enable (MSBE)	Parity Bit Enable (PBE)	Even Parity Enable (EPE)	Parity Bit Fixed Enable (PBFE)	Set Silence Enable (SSE)	Baudrate Divisor Latch Access Bit (BDLAB)
+ 4	Handshake Control Register	HCR	Data Terminal Ready (DTR)	Request to Send (RTS)	Loopback RI Input	IRQ Enable	Internal Loopback Enable	0	0	0
+ 5	UART Status Register	USR	RBR Data Ready (RDR)	Overrun Error (OER)	Parity Bit Error (PBER)	No Stop Bit Error (NSER)	Silent Byte Detected (SBD)	TBR Empty (TBRE)	TSR Empty (TSRE)	RX FIFO Error Indication (RFEI) **
+ 6	Handshake Status Register	HSR	CTS Toggling (TCTS)	DSR Toggling (TDSR)	RI Falling Edge (FERI)	DCD Toggling (TDCD)	Clear to Send (CTS)	Data Set Ready (DSR)	Ring Indicator (RI)	Data Carrier Detect (DCD)
+ 7	User Defined Register	UDR	Bit 0	Bit 1	Bit 2	Bit 3	Bit 4	Bit 5	Bit 6	Bit 7
+ 0 BDLAB = 1	Baudrate Divisor Latch Low	BLL	Bit 0	Bit 1	Bit 2	Bit 3	Bit 4	Bit 5	Bit 6	Bit 7
+ 1 BDLAB = 1	Baudrate Divisor Latch High	BHL	Bit 8	Bit 9	Bit 10	Bit 11	Bit 12	Bit 13	Bit 14	Bit 15

*: Bit 0 is the least significant bit. The least significant bit is the first bit serially transmitted or received.

** : These bits are always 0 in 16450 Mode.



- Bit 4: EPE. This bit describes the number of logic 1's in the data word bits and parity bit only when bit 3 is programmed. When this bit is set, an even number of logic 1's are sent or checked. When the bit is reset, an odd number of logic 1's are sent or checked.
- Bit 3: PBE. When this bit is set, the position between the last data bit and the stop bit of the SOUT will be stuffed with the parity bit at the transmitter. For the receiver, the parity bit in the same position as the transmitter will be detected.
- Bit 2: MSBE. This bit defines the number of stop bits in each serial character that is transmitted or received.
- (1) If MSBE is set to a logical 0, one stop bit is sent and checked.
 - (2) If MSBE is set to a logical 1, and data length is 5 bits, one and a half stop bits are sent and checked.
 - (3) If MSBE is set to a logical 1, and data length is 6, 7, or 8 bits, two stop bits are sent and checked.
- Bits 0 and 1: DLS0, DLS1. These two bits define the number of data bits that are sent or checked in each serial character.

TABLE 4-2 WORD LENGTH DEFINITION

DLS1	DLS0	DATA LENGTH
0	0	5 bits
0	1	6 bits
1	0	7 bits
1	1	8 bits

4.2.2 UART Status Register (USR) (Read/Write)

This 8-bit register provides information about the status of the data transfer during communication.

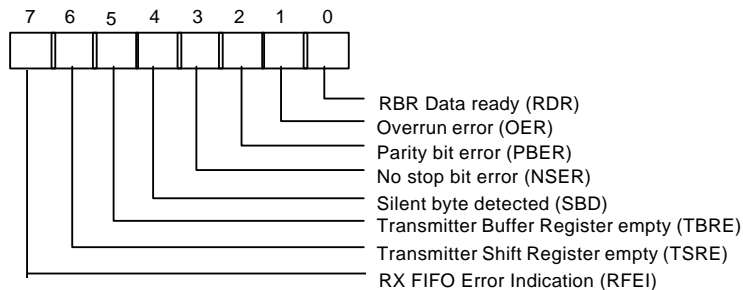

- Bit 7: RFEI. In 16450 mode, this bit is always set to a logic 0. In 16550 mode, this bit is set to a logic 1 when there is at least one parity bit error, no stop bit error or silent byte detected in the FIFO. In 16550 mode, this bit is cleared by reading from the USR if there are no remaining errors left in the FIFO.
- Bit 6: TSRE. In 16450 mode, when TBR and TSR are both empty, this bit will be set to a logical 1. In 16550 mode, if the transmit FIFO and TSR are both empty, it will be set to a logical 1. Other than these two cases, this bit will be reset to a logical 0.
- Bit 5: TBRE. In 16450 mode, when a data character is transferred from TBR to TSR, this bit will be set to a logical 1. If ETREI or ICR is a logical 1, an interrupt will be generated to notify the CPU to write the next data. In 16550 mode, this bit will be set to a logical 1 when the transmit FIFO is empty. It will be reset to a logical 0 when the CPU writes data into TBR or FIFO.
- Bit 4: SBD. This bit is set to a logical 1 to indicate that received data are kept in silent state for a full word time, including start bit, data bits, parity bit, and stop bits. In 16550 mode, it indicates the same condition for the data on top of the FIFO. When the CPU reads USR, it will clear this bit to a logical 0.
- Bit 3: NSER. This bit is set to a logical 1 to indicate that the received data have no stop bit. In 16550 mode, it indicates the same condition for the data on top of the FIFO. When the CPU reads USR, it will clear this bit to a logical 0.
- Bit 2: PBER. This bit is set to a logical 1 to indicate that the parity bit of received data is wrong. In 16550 mode, it indicates the same condition for the data on top of the FIFO. When the CPU reads USR, it will clear this bit to a logical 0.
- Bit 1: OER. This bit is set to a logical 1 to indicate received data have been overwritten by the next received data before they were read by the CPU. In 16550 mode, it indicates the same condition instead of FIFO full. When the CPU reads USR, it will clear this bit to a logical 0.
- Bit 0: RDR. This bit is set to a logical 1 to indicate received data are ready to be read by the CPU in the RBR or FIFO. After no data are left in the RBR or FIFO, the bit will be reset to a logical 0.

4.2.3 Handshake Control Register (HCR) (Read/Write)

This register controls the pins of the UART used for handshaking peripherals such as modem, and controls the diagnostic mode of the UART.

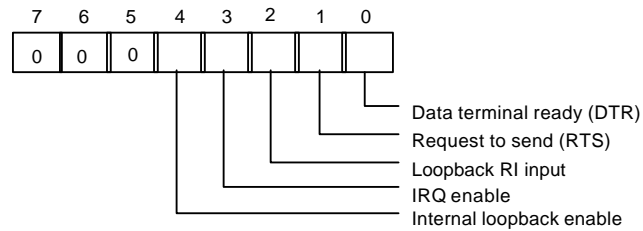

Bit 4: When this bit is set to a logical 1, the UART enters diagnostic mode by an internal loopback, as follows:

- (1) SOUT is forced to logical 1, and SIN is isolated from the communication link instead of the TSR.
- (2) Modem output pins are set to their inactive state.
- (3) Modem input pins are isolated from the communication link and connect internally as DTR (bit 0 of HCR) \rightarrow \overline{DSR} , RTS (bit 1 of HCR) \rightarrow \overline{CTS} , Loopback RI input (bit 2 of HCR) \rightarrow \overline{RI} and IRQ enable (bit 3 of HCR) \rightarrow \overline{DCD} .

Aside from the above connections, the UART operates normally. This method allows the CPU to test the UART in a convenient way.

Bit 3: The UART interrupt output is enabled by setting this bit to a logic 1. In the diagnostic mode this bit is internally connected to the modem control input \overline{DCD} .

Bit 2: This bit is used only in the diagnostic mode. In the diagnostic mode this bit is internally connected to the modem control input \overline{RI} .

Bit 1: This bit controls the \overline{RTS} output. The value of this bit is inverted and output to \overline{RTS} .

Bit 0: This bit controls the \overline{DTR} output. The value of this bit is inverted and output to \overline{DTR} .

4.2.4 Handshake Status Register (HSR) (Read/Write)

This register reflects the current state of four input pins for handshake peripherals such as a modem and records changes on these pins.

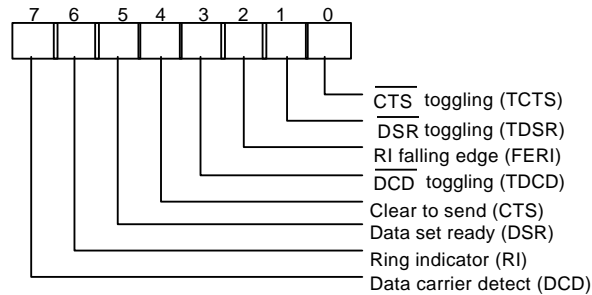

Bit 7: This bit is the opposite of the $\overline{\text{DCD}}$ input. This bit is equivalent to bit 3 of HCR in loopback mode.

Bit 6: This bit is the opposite of the $\overline{\text{RI}}$ input. This bit is equivalent to bit 2 of HCR in loopback mode.

Bit 5: This bit is the opposite of the $\overline{\text{DSR}}$ input. This bit is equivalent to bit 0 of HCR in loopback mode.

Bit 4: This bit is the opposite of the $\overline{\text{CTS}}$ input. This bit is equivalent to bit 1 of HCR in loopback mode.

Bit 3: TDCD. This bit indicates that the $\overline{\text{DCD}}$ pin has changed state after HSR was read by the CPU.

Bit 2: FERL. This bit indicates that the $\overline{\text{RI}}$ pin has changed from low to high state after HSR was read by the CPU.

Bit 1: TDSR. This bit indicates that the $\overline{\text{DSR}}$ pin has changed state after HSR was read by the CPU.

Bit 0: TCTS. This bit indicates that the $\overline{\text{CTS}}$ pin has changed state after HSR was read.



4.2.5 UART FIFO Control Register (UFR) (Write only)

This register is used to control the FIFO functions of the UART.

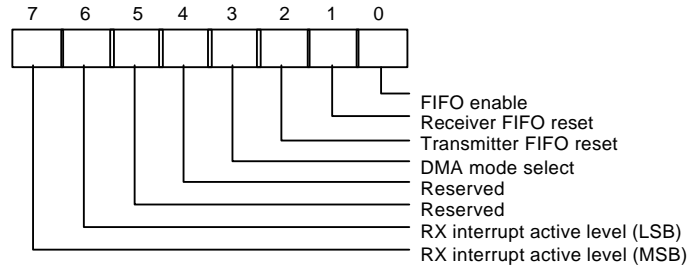

Bit 6, 7: These two bits are used to set the active level for the receiver FIFO interrupt. For example, if the interrupt active level is set as 4 bytes, once there are more than 4 data characters in the receiver FIFO, the interrupt will be activated to notify the CPU to read the data from the FIFO.

TABLE 4-3 FIFO TRIGGER LEVEL

BIT 7	BIT 6	RX FIFO INTERRUPT ACTIVE LEVEL (BYTES)
0	0	01
0	1	04
1	0	08
1	1	14

Bit 4, 5: Reserved

Bit 3: When this bit is programmed to logic 1, the DMA mode will change from mode 0 to mode 1 if UFR bit 0 = 1.

Bit 2: Setting this bit to a logical 1 resets the TX FIFO counter logic to initial state. This bit will clear to a logical 0 by itself after being set to a logical 1.

Bit 1: Setting this bit to a logical 1 resets the RX FIFO counter logic to initial state. This bit will clear to a logical 0 by itself after being set to a logical 1.

Bit 0: This bit enables the 16550 (FIFO) mode of the UART. This bit should be set to a logical 1 before other bits of UFR are programmed.



4.2.6 Interrupt Status Register (ISR) (Read only)

This register reflects the UART interrupt status, which is encoded by different interrupt sources into 3 bits.

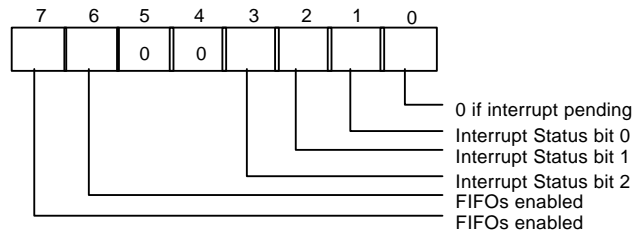

Bit 7, 6: These two bits are set to a logical 1 when UFR bit 0 = 1.

Bit 5, 4: These two bits are always logic 0.

Bit 3: In 16450 mode, this bit is 0. In 16550 mode, both bit 3 and 2 are set to a logical 1 when a time-out interrupt is pending.

Bit 2, 1: These two bits identify the priority level of the pending interrupt, as shown in the table below.

Bit 0: This bit is a logical 1 if there is no interrupt pending. If one of the interrupt sources has occurred, this bit will be set to a logical 0.

TABLE 4-4 INTERRUPT CONTROL FUNCTION

ISR				INTERRUPT SET AND FUNCTION			
Bit 3	Bit 2	Bit 1	Bit 0	Interrupt priority	Interrupt Type	Interrupt Source	Clear Interrupt
0	0	0	1	-	-	No Interrupt pending	-
0	1	1	0	First	UART Receive Status	1. OER = 1 2. PBER =1 3. NSER = 1 4. SBD = 1	Read USR
0	1	0	0	Second	RBR Data Ready	1. RBR data ready 2. FIFO interrupt active level reached	1. Read RBR 2. Read RBR until FIFO data under active level
1	1	0	0	Second	FIFO Data Timeout	Data present in RX FIFO for 4 characters period of time since last access of RX FIFO.	Read RBR
0	0	1	0	Third	TBR Empty	TBR empty	1. Write data into TBR 2. Read ISR (if priority is third)
0	0	0	0	Fourth	Handshake status	1. TCTS = 1 2. TDSR = 1 3. FER1 = 1 4. TDCD = 1	Read HSR

** Bit 3 of ISR is enabled when bit 0 of UFR is logical 1.

4.2.7 Interrupt Control Register (ICR) (Read/Write)

This 8bit register allows the five types of controller interrupts to activate the interrupt output signal separately. The interrupt system can be totally disabled by resetting bits 0 through 3 of the Interrupt Control Register (ICR). A selected interrupt can be enabled by setting the appropriate bits of this register to a logical 1.

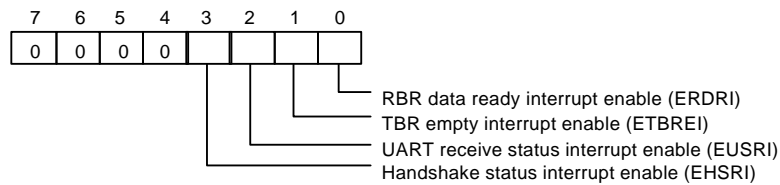

Bit 7-4: These four bits are always logic 0.

Bit 3: EHSRI. Setting this bit to a logical 1 enables the handshake status register interrupt.

Bit 2: EUSRI. Setting this bit to a logical 1 enables the UART status register interrupt.

Bit 1: ETBREI. Setting this bit to a logical 1 enables the TBR empty interrupt.

Bit 0: ERDRI. Setting this bit to a logical 1 enables the RBR data ready interrupt.

4.2.8 Programmable Baud Generator (BLL/BHL) (Read/Write)

Two 8bit registers, BLL and BHL, compose a programmable baud generator that uses 24 MHz to generate a 1.8461 MHz frequency and divides it by a divisor from 1 to $2^{16}-1$. The output frequency of the baud generator is the baud rate multiplied by 16, and this is the base frequency for the transmitter and receiver. The table in the next page illustrates the use of the baud generator with a frequency of 1.8461 MHz. In high-speed UART mode (refer to CROC bit7 and CROC bit6), the programmable baud generator directly uses 24 MHz and the same divisor as the normal speed divisor. In high-speed mode, the data transmission rate can be as high as 1.5M bps.



4.2.9 User-defined Register (UDR) (Read/Write)

This is a temporary register that can be accessed and defined by the user.

TABLE 4-5 BAUD RATE TABLE

BAUD RATE FROM DIFFERENT PRE-DIVIDER				
Pre-Div: 13 1.8461M Hz	Pre-Div:1.625 14.769M Hz	Pre-Div: 1.0 24M Hz	Decimal divisor used to generate 16X clock	Error Percentage between desired and actual
50	400	650	2304	**
75	600	975	1536	**
110	880	1430	1047	0.18%
134.5	1076	1478.5	857	0.099%
150	1200	1950	768	**
300	2400	3900	384	**
600	4800	7800	192	**
1200	9600	15600	96	**
1800	14400	23400	64	**
2000	16000	26000	58	0.53%
2400	19200	31200	48	**
3600	28800	46800	32	**
4800	38400	62400	24	**
7200	57600	93600	16	**
9600	76800	124800	12	**
19200	153600	249600	6	**
38400	307200	499200	3	**
57600	460800	748800	2	**
115200	921600	1497600	1	**

** The percentage error for all baud rates, except where indicated otherwise, is 0.16%.

Note. Pre-Divisor is determined by CRF0 of UART A and B.

5. CIR RECEIVER PORT

5.1 CIR Registers

5.1.1 Bank0.Reg0 - Receiver Buffer Registers (RBR) (Read)

Receiver Buffer Register is read only. When the CIR pulse train has been detected and passed by the internal signal filter, the data sampled and shifted into shifter register will write into Receiver Buffer Register. In the CIR, this port is only supports PIO mode and the address port is defined in the PnP.

5.1.2 Bank0.Reg1 - Interrupt Control Register (ICR)

Power on default <7:0> = 00000000 binary

Bit	Name	Read/Write	Description
7	EN_GLBI	Read/Write	Enable Global Interrupt. Write 1, enable interrupt. Write 0, disable global interrupt.
6-3	Reserved	-	Reserved
2	EN_TMR_I	Read/Write	Enable Timer Interrupt.
1	En_LSR_I	Read/Write	Enable Line-Status-Register interrupt.
0	EN_RX_I	Read/Write	Receiver Thershold-Level Interrupt Enable.

5.1.3 Bank0.Reg2 - Interrupt Status Register (ISR)

Power on default <7:0> = 00000000 binary

Bit	Name	Read/Write	Description
7-3	Reserved		Reserved
2	TMR_I	Read Only	Timer Interrupt. Set to 1 when timer count to 0. This bit will be affected by (1) the timer registers are defined in Bank4.Reg0 and Bank1.Reg0~1, (2) EN_TMR(Enable Timer, in Bank0.Reg3.Bit2) should be set to 1, (3) ENTMR_I (Enable Timer Interrupt, in Bank0.Reg1.Bit2) should be set to 1.
1	LSR_I	Read Only	Line-Status-Register interrupt. Set to 1 when overrun, or parity bit, or stop bit, or silent byte detected error in the Line Status Register (LSR) sets to 1. Clear to 0 when LSR is read.
0	RXTH_I	Read Only	Receiver Thershold-Level Interrupt. Set to 1 when (1) the Receiver Buffer Register (RBR) is equal or larger than the threshold level, (2) RBR occurs time-out if the receiver buffer register has valid data and below the threshold level. Clear to 0 when RBR is less than threshold level from reading RBR.



5.1.4 Bank0~3.Reg3 - CIR Control Register 0/Bank Select Register (CTR0/BSR) (BANK0~3)

Power on default <7:0> = 00000000 binary

Bit	Name	Read/Write	Description
7-6	BNK_SEL<1:0>	Read/Write	Bank Select Register. These two bits are shared same address so that <i>Bank Select Register (BSR)</i> can be programmed to desired Bank in any Bank. BNK_SEL<1:0> = 00 Select Bank 0. BNK_SEL<1:0> = 01 Select Bank 1. BNK_SEL<1:0> = Reserved. BNK_SEL<1:0> = Reserved.
5-4	RXFTL1/0	Read/Write	Receiver FIFO Threshold Level. It is to determine the RXTH_I to become 1 when the Receiver FIFO Threshold Level is equal or larger than the defined value shown as follow. RXFTL<1:0> = 00 -- 1 byte RXFTL<1:0> = 01 -- 4 bytes RXFTL<1:0> = 10 -- 8 bytes RXFTL<1:0> = 11 -- 14 bytes
3	TMR_TST	Read/Write	Timer Test. Write to 1, then reading the TMRL/TMRH will return the programmed values of TMRL/TMRH, that is, does not return down count counter value. This bit is for test timer register.
2	EN_TMR	Read/Write	Enable timer. Write to 1, enable the timer
1	RXF_RST	Read/Write	Setting this bit to a logical 1 resets the RX FIFO counter logic to initial state. This bit will clear to a logical 0 by itself after being set to a logical 1.
0	TMR_CLK	Read/Write	Timer input clock. Winbond test register



5.1.5 Bank0.Reg4 - CIR Control Register (CTR)

Power on default <7:0> = 0010,1001 binary

Bit	Name	Read/Write	Description
7-5	RX_FR<2:0>	Read/Write	Receiver Frequency Range 2~0. These bits select the input frequency of the receiver ranges. For the input signal, that is through a band pass filter, i.e., the frequency of the input signal is located at this defined range then the signal will be received.
4-0	RX_FSL<4:0>	Read/Write	Receiver Frequency Select 4~0. Select the receiver operation frequency.

Table: Low Frequency range select of receiver.

RX_FSL4~0	RX_FR2~0 (Low Frequency)					
	001		010		011	
	Min.	Max.	Min.	Max.	Min.	Max.
00010	26.1	29.6	24.7	31.7	23.4	34.2
00011	28.2	32.0	26.7	34.3	25.3	36.9
00100	29.4	33.3	27.8	35.7	26.3	38.4
00101	30.0	34.0	28.4	36.5	26.9	39.3
00110	31.4	35.6	29.6	38.1	28.1	41.0
00111	32.1	36.4	30.3	39.0	28.7	42.0
01000	32.8	37.2	31.0	39.8	29.4	42.9
01001	33.6*	38.1*	31.7	40.8	30.1	44.0
01011	34.4	39.0	32.5	41.8	30.8	45.0
01100	36.2	41.0	34.2	44.0	32.4	47.3
01101	37.2	42.1	35.1	45.1	33.2	48.6
01111	38.2	43.2	36.0	46.3	34.1	49.9
10000	40.3	45.7	38.1	49.0	36.1	52.7
10010	41.5	47.1	39.2	50.4	37.2	54.3
10011	42.8	48.5	40.4	51.9	38.3	56.0
10101	44.1	50.0	41.7	53.6	39.5	57.7
10111	45.5	51.6	43.0	55.3	40.7	59.6
11010	48.7	55.2	46.0	59.1	43.6	63.7
11011	50.4	57.1	47.6	61.2	45.1	65.9
11101	54.3	61.5	51.3	65.9	48.6	71.0

Note that the other non-defined values are reserved.



5.1.6 Bank0.Reg5 - UART Line Status Register (USR)

Power on default <7:0> = 0000,0000 binary

Bit	Name	Read/Write	Description
7-3	Reserved	-	-
2	RX_TO	Read/Write	Set to 1 when receiver FIFO or frame status FIFO occurs time-out. Read this bit will be cleared.
1	OV_ERR	Read/Write	Received FIFO overrun. Read to clear.
0	RDR	Read/Write	This bit is set to a logical 1 to indicate received data are ready to be read by the CPU in the RBR or FIFO. After no data are left in the RBR or FIFO, the bit will be reset to a logical 0.

5.1.7 Bank0.Reg6 - Remote Infrared Config Register (RIR_CFG)

Power on default <7:0> = 0000,0000 binary

Bit	Name	Read/Write	Description
7-6	SMPSEL<1:0>	Read/Write	<p>Sampling Mode Select. Select internal decoder methodology from the internal filter. Selected decoder mode will determine the receive data format. The sampling mode is shown as below:</p> <p>SMPSEL<1:0> = 00 T-Period Sample Mode. SMPSEL<1:0> = 01 Over-Sampling Mode. SMPSEL<1:0> = 10 Over-Sampling with re-sync. SMPSEL<1:0> = 11 FIFO Test Mode.</p> <p>The T-period code format is defined as follows.</p> <div style="text-align: center;"> </div> <p>The Bit value is set to 0, then the high pulse will be received. The Bit value is set to 1, then no energy will be received. The opposite results will be generated when the bit RXINV (Bank0.Reg6.Bit0) is set to 1.</p>



5.1.7 Bank0.Reg6 - Remote Infrared Config Register (RIR_CFG), continued

Power on default <7:0> = 0000,0000 binary

Bit	Name	Read/Write	Description
5-4	LP_SL<1:0>	Read/Write	Low pass filter source selection. LP_SL<1:0> = 00 Select raw IRRX signal. LP_SL<1:0> = 01 Select R.B.P. signal LP_SL<1:0> = 10 Select D.B.P. signal. LP_SL<1:0> = 11 Reserved.
3-2	RXDMSL<1:0>	Read/Write	Receiver Demodulation Source Selection. RXDMSL<1:0> = 00 select B.P. and L.P. filter. RXDMSL<1:0> = 01 select B.P. but not L.P. RXDMSL<1:0> = 10 Reserved. RXDMSL<1:0> = 11 do not pass demodulation.
1	PRE_DIV	Read/Write	Baud Rate Pre-divisor. Set to 1, the baud rate generator input clock is set to 1.8432M Hz which is set to pre-divisor into 13. When set to 0, the pre-divisor is set to 1, that is, the input clock of baud rate generator is set to 24M Hz.
0	RXINV	Read/Write	Receiving Signal Invert. Write to 1, Invert the receiving signal.

5.1.8 Bank0.Reg7 - User Defined Register (UDR/AUDR)

Power on default <7:0> = 0000,0000 binary

Bit	Name	Read/Write	Description
7	RXACT	Read/Write	Receive Active. Set to 1 whenever a pulse or pulse-train is detected by the receiver. If a 1 is written into the bit position, the bit is cleared and the receiver is de-activated. When this bit is set, the receiver samples the IR input continuously at the programmed baud rate and transfers the data to the receiver FIFO.
6	RX_PD	Read Only	Set to 1 whenever a pulse or pulse-train (modulated pulse) is detected by the receiver. Can be used by the software to detect idle condition Cleared Upon Read.
5	Reserved	-	-
4-0	FOLVAL	Read Only	FIFO Level Value. Indicate that how many bytes are there in the current received FIFO. Can read these bits then get the FIFO level value and successively read RBR by the prior value.

5.1.9 Bank1.Reg0~1 - Baud Rate Divisor Latch (BLL/BHL)

The two registers of BLL and BHL are baud rate divisor latch in the legacy UART/SIR/ASK-IR mode. Read/Write these registers, if set in Advanced UART mode, will occur backward operation, that is, will go to legacy UART mode and clear some register values shown table as follows.

TABLE :BAUD RATE TABLE

BAUD RATE USING 24 MHZ TO GENERATE 1.8461 MHZ		
Desired Baud Rate	Decimal divisor used to generate 16X clock	Percent error difference between desired and actual
50	2304	**
75	1536	**
110	1047	0.18%
134.5	857	0.099%
150	768	**
300	384	**
600	192	**
1200	96	**
1800	64	**
2000	58	0.53%
2400	48	**
3600	32	**
4800	24	**
7200	16	**
9600	12	**
19200	6	**
38400	3	**
57600	2	**
115200	1	**
1.5M	¹ Note 1	0%

Note 1: Only use in high speed mode, when Bank0.Reg6.Bit7 is set.

** The percentage error for all baud rates, except where indicated otherwise, is 0.16%



5.1.10 Bank1.Reg2 - Version ID Register I (VID)

Power on default <7:0> = 0001,0000 binary

Bit	Name	Read/Write	Description
7-0	VID	Read Only	Version ID, default is set to 0x10.

5.1.11 Bank0~3.Reg3 - CIR Control Register 0/Bank Select Register (CTR0/BSR) (BANK0~3)

This register is defined same as in Bank0.Reg3.

5.1.12 Bank1.Reg4 - Timer Low Byte Register (TMRL)

Power on default <7:0> = 0000,0000 binary

Bit	Name	Read/Write	Description
7-0	TMRL	Read/Write	Timer Low Byte Register. This is a 12-bit timer (another 4 bit is defined in Bank1.Reg5) which resolution is 1 ms, that is, the programmed maximum time is $2^{12}-1$ ms. The timer is a down-counter. The timer start down count when the bit EN_TMR (Enable Timer) of Bank0.Reg2. is set to 1. When the timer down count to zero and EN_TMR=1, the TMR_I is set to 1. When the counter down count to zero, a new initial value will be re-loaded into timer counter.

5.1.13 Bank1.Reg5 - Timer High Byte Register (TMRH)

Power on default <7: 0> = 0000,0000 binary

Bit	Name	Read/Write	Description
7-4	Reserved		Reserved.
3-0	TMRH	Read/Write	Timer High Byte Register. See Bank1.Reg4.

6. PARALLEL PORT

6.1 Printer Interface Logic

The parallel port of the W83627HF makes possible the attachment of various devices that accept eight bits of parallel data at standard TTL level. The W83627HF supports an IBM XT/AT compatible parallel port (SPP), bi-directional parallel port (BPP), Enhanced Parallel Port (EPP), Extended Capabilities Parallel Port (ECP), Extension FDD mode (EXTFDD), Extension 2FDD mode (EXT2FDD) on the parallel port. Refer to the configuration registers for more information on disabling, power-down, and on selecting the mode of operation.

Table 6-1 shows the pin definitions for different modes of the parallel port.

TABLE 6-1-1 PARALLEL PORT CONNECTOR AND PIN DEFINITIONS

HOST CONNECTOR	PIN NUMBER OF W83627HF	PIN ATTRIBUTE	SPP	EPP	ECP
1	36	O	nSTB	nWrite	nSTB, HostClk ²
2-9	31-26, 24-23	I/O	PD<0:7>	PD<0:7>	PD<0:7>
10	22	I	nACK	Intr	nACK, PeriphClk ²
11	21	I	BUSY	nWait	BUSY, PeriphAck ²
12	19	I	PE	PE	PEerror, nAckReverse ²
13	18	I	SLCT	Select	SLCT, Xflag ²
14	35	O	nAFD	nDStrb	nAFD, HostAck ²
15	34	I	nERR	nError	nFault ¹ , nPeriphRequest ²
16	33	O	nINIT	nInit	nINIT ¹ , nReverseRqs ²
17	32	O	nSLIN	nAStrb	nSLIN ¹ , ECPMode ²

Notes:

n<name > : Active Low

1. Compatible Mode

2. High Speed Mode

3. For more information, refer to the IEEE 1284 standard.



TABLE 6-1-2 PARALLEL PORT CONNECTOR AND PIN DEFINITIONS

HOST CONNECTOR	PIN NUMBER OF W83627HF	PIN ATTRIBUTE	SPP	PIN ATTRIBUTE	EXT2FDD	PIN ATTRIBUTE	EXTFDD
1	36	O	nSTB	---	---	---	---
2	31	I/O	PD0	I	INDEX2#	I	INDEX2#
3	30	I/O	PD1	I	TRAK02#	I	TRAK02#
4	29	I/O	PD2	I	WP2#	I	WP2#
5	28	I/O	PD3	I	RDATA2#	I	RDATA2#
6	27	I/O	PD4	I	DSKCHG2#	I	DSKCHG2#
7	26	I/O	PD5	---	---	---	---
8	24	I/O	PD6	OD	MOA2#	---	---
9	23	I/O	PD7	OD	DSA2#	---	---
10	22	I	nACK	OD	DSB2#	OD	DSB2#
11	21	I	BUSY	OD	MOB2#	OD	MOB2#
12	19	I	PE	OD	WD2#	OD	WD2#
13	18	I	SLCT	OD	WE2#	OD	WE2#
14	35	O	nAFD	OD	RWC2#	OD	RWC2#
15	34	I	nERR	OD	HEAD2#	OD	HEAD2#
16	33	O	nINIT	OD	DIR2#	OD	DIR2#
17	32	O	nSLIN	OD	STEP2#	OD	STEP2#

6.2 Enhanced Parallel Port (EPP)

TABLE 6-2 PRINTER MODE AND EPP REGISTER ADDRESS

A2	A1	A0	REGISTER	NOTE
0	0	0	Data port (R/W)	1
0	0	1	Printer status buffer (Read)	1
0	1	0	Printer control latch (Write)	1
0	1	0	Printer control swapper (Read)	1
0	1	1	EPP address port (R/W)	2
1	0	0	EPP data port 0 (R/W)	2
1	0	1	EPP data port 1 (R/W)	2
1	1	0	EPP data port 2 (R/W)	2
1	1	1	EPP data port 2 (R/W)	2

Notes:

1. These registers are available in all modes.
2. These registers are available only in EPP mode.

6.2.1 Data Swapper

The system microprocessor can read the contents of the printer's data latch by reading the data swapper.

6.2.2 Printer Status Buffer

The system microprocessor can read the printer status by reading the address of the printer status buffer. The bit definitions are as follows:

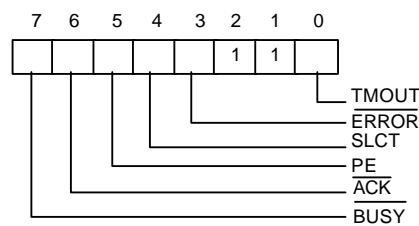

Bit 7: This signal is active during data entry, when the printer is off-line during printing, when the print head is changing position, or during an error state. When this signal is active, the printer is busy and cannot accept data.

Bit 6: This bit represents the current state of the printer's **ACK#** signal. A 0 means the printer has received a character and is ready to accept another. Normally, this signal will be active for approximately 5 microseconds before **BUSY#** stops.

Bit 5: Logical 1 means the printer has detected the end of paper.

Bit 4: Logical 1 means the printer is selected.

Bit 3: Logical 0 means the printer has encountered an error condition.

Bit 1, 2: These two bits are not implemented and are logic one during a read of the status register.

Bit 0: This bit is valid in EPP mode only. It indicates that a 10 μ S time-out has occurred on the EPP bus. A logic 0 means that no time-out error has occurred; a logic 1 means that a time-out error has been detected. Writing a logic 1 to this bit will clear the time-out status bit; writing a logic 0 has no effect.

6.2.3 Printer Control Latch and Printer Control Swapper

The system microprocessor can read the contents of the printer control latch by reading the printer control swapper. Bit definitions are as follows:

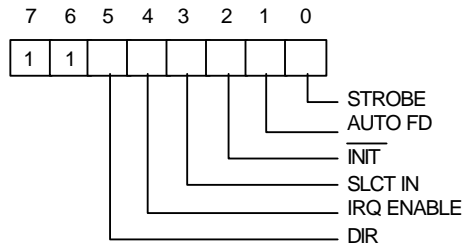

Bit 7, 6: These two bits are a logic one during a read. They can be written.

Bit 5: Direction control bit

When this bit is a logic 1, the parallel port is in input mode (read); when it is a logic 0, the parallel port is in output mode (write). This bit can be read and written. In SPP mode, this bit is invalid and fixed at zero.

Bit 4: A 1 in this position allows an interrupt to occur when ACK# changes from low to high.

Bit 3: A 1 in this bit position selects the printer.

Bit 2: A 0 starts the printer (50 microsecond pulse, minimum).

Bit 1: A 1 causes the printer to line-feed after a line is printed.

Bit 0: A 0.5 microsecond minimum high active pulse clocks data into the printer. Valid data must be present for a minimum of 0.5 microseconds before and after the strobe pulse.

6.2.4 EPP Address Port

The address port is available only in EPP mode. Bit definitions are as follows:

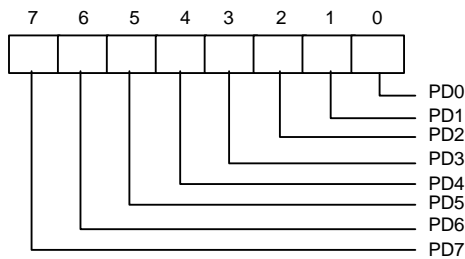



The contents of DB0-DB7 are buffered (non-inverting) and output to ports PD0-PD7 during a write operation. The leading edge of IOW# causes an EPP address write cycle to be performed, and the trailing edge of IOW# latches the data for the duration of the EPP write cycle.

PD0-PD7 ports are read during a read operation. The leading edge of IOR# causes an EPP address read cycle to be performed and the data to be output to the host CPU.

6.2.5 EPP Data Port 0-3

These four registers are available only in EPP mode. Bit definitions of each data port are as follows:

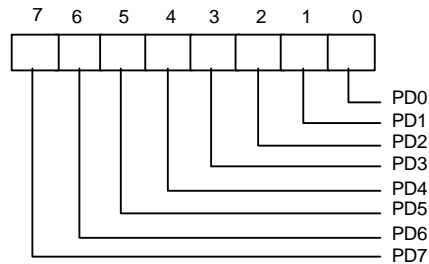

When accesses are made to any EPP data port, the contents of DB0-DB7 are buffered (non-inverting) and output to the ports PD0-PD7 during a write operation. The leading edge of IOW# causes an EPP data write cycle to be performed, and the trailing edge of IOW# latches the data for the duration of the EPP write cycle.

During a read operation, ports PD0-PD7 are read, and the leading edge of IOR# causes an EPP read cycle to be performed and the data to be output to the host CPU.

6.2.6 Bit Map of Parallel Port and EPP Registers

REGISTER	7	6	5	4	3	2	1	0
Data Port (R/W)	PD7	PD6	PD5	PD4	PD3	PD2	PD1	PD0
Status Buffer (Read)	BUSY#	ACK#	PE	SLCT	ERROF#	1	1	TMOUT
Control Swapper (Read)	1	1	1	IRQEN	SLIN	INIT#	AUTOFD#	STROBE#
Control Latch (Write)	1	1	DIR	IRQ	SLIN	INIT#	AUTOFD#	STROBE#
EPP Address Port R/W)	PD7	PD6	PD5	PD4	PD3	PD2	PD1	PD0
EPP Data Port 0 (R/W)	PD7	PD6	PD5	PD4	PD3	PD2	PD1	PD0
EPP Data Port 1 (R/W)	PD7	PD6	PD5	PD4	PD3	PD2	PD1	PD0
EPP Data Port 2 (R/W)	PD7	PD6	PD5	PD4	PD3	PD2	PD1	PD0
EPP Data Port 3 (R/W)	PD7	PD6	PD5	PD4	PD3	PD2	PD1	PD0

6.2.7 EPP Pin Descriptions

EPP NAME	TYPE	EPP DESCRIPTION
nWrite	O	Denotes an address or data read or write operation.
PD<0:7>	I/O	Bi-directional EPP address and data bus.
Intr	I	Used by peripheral device to interrupt the host.
nWait	I	Inactive to acknowledge that data transfer is completed. Active to indicate that the device is ready for the next transfer.
PE	I	Paper end; same as SPP mode.
Select	I	Printer selected status; same as SPP mode.
nDStrb	O	This signal is active low. It denotes a data read or write operation.
nError	I	Error; same as SPP mode.
nInits	O	This signal is active low. When it is active, the EPP device is reset to its initial operating mode.
nAStrb	O	This signal is active low. It denotes an address read or write operation.

6.2.8 EPP Operation

When the EPP mode is selected in the configuration register, the standard and bi-directional modes are also available. The PDx bus is in the standard or bi-directional mode when no EPP read, write, or address cycle is currently being executed. In this condition all output signals are set by the SPP Control Port and the direction is controlled by DIR of the Control Port.

A watchdog timer is required to prevent system lockup. The timer indicates that more than 10 μ S have elapsed from the start of the EPP cycle to the time WAIT# is deasserted. The current EPP cycle is aborted when a time-out occurs. The time-out condition is indicated in Status bit 0.

6.2.8.1 EPP Operation

The EPP operates on a two-phase cycle. First, the host selects the register within the device for subsequent operations. Second, the host performs a series of read and/or write byte operations to the selected register. Four operations are supported on the EPP: Address Write, Data Write, Address Read, and Data Read. All operations on the EPP device are performed asynchronously.

6.2.8.2 EPP Version 1.9 Operation

The EPP read/write operation can be completed under the following conditions:

- If the nWait is active low, when the read cycle (nWrite inactive high, nDStrb/nAStrb active low) or write cycle (nWrite active low, nDStrb/nAStrb active low) starts, the read/write cycle proceeds normally and will be completed when nWait goes inactive high.
- If nWait is inactive high, the read/write cycle will not start. It must wait until nWait changes to active low, at which time it will start as described above.

6.2.8.3 EPP Version 1.7 Operation

The EPP read/write cycle can start without checking whether nWait is active or inactive. Once the read/write cycle starts, however, it will not terminate until nWait changes from active low to inactive high.



6.3 Extended Capabilities Parallel (ECP) Port

This port is software and hardware compatible with existing parallel ports, so it may be used as a standard printer mode if ECP is not required. It provides an automatic high burst-bandwidth channel that supports DMA for ECP in both the forward (host to peripheral) and reverse (peripheral to host) directions. Small FIFOs are used in both forward and reverse directions to improve the maximum bandwidth requirement. The size of the FIFO is 16 bytes. The ECP port supports an automatic handshake for the standard parallel port to improve compatibility mode transfer speed.

The ECP port supports run-length-encoded (RLE) decompression (required) in hardware. Compression is accomplished by counting identical bytes and transmitting an RLE byte that indicates how many times the next byte is to be repeated. Hardware support for compression is optional.

For more information about the ECP Protocol, refer to the Extended Capabilities Port Protocol and ISA Interface Standard.

6.3.1 ECP Register and Mode Definitions

NAME	ADDRESS	I/O	ECP MODES	FUNCTION
data	Base+000h	R/W	000-001	Data Register
ecpAFifo	Base+000h	R/W	011	ECP FIFO (Address)
dsr	Base+001h	R	All	Status Register
dcr	Base+002h	R/W	All	Control Register
cFifo	Base+400h	R/W	010	Parallel Port Data FIFO
ecpDFifo	Base+400h	R/W	011	ECP FIFO (DATA)
tFifo	Base+400h	R/W	110	Test FIFO
cnfgA	Base+400h	R	111	Configuration Register A
cnfgB	Base+401h	R/W	111	Configuration Register B
ecr	Base+402h	R/W	All	Extended Control Register

Note: The base addresses are specified by CR23, which are determined by configuration register or hardware setting.

MODE	DESCRIPTION
000	SPP mode
001	PS/2 Parallel Port mode
010	Parallel Port Data FIFO mode
011	ECP Parallel Port mode
100	EPP mode (If this option is enabled in the CR9 and CR0 to select ECP/EPP mode)
101	Reserved
110	Test mode
111	Configuration mode

Note: The mode selection bits are bit 7-5 of the Extended Control Register.

6.3.2 Data and ecpAFifo Port

Modes 000 (SPP) and 001 (PS/2) (Data Port)

During a write operation, the Data Register latches the contents of the data bus on the rising edge of the input. The contents of this register are output to the PD0-PD7 ports. During a read operation, ports PD0-PD7 are read and output to the host. The bit definitions are as follows:

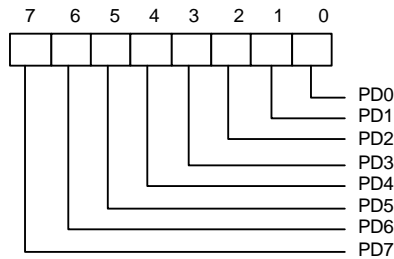

Mode 011 (ECP FIFO-Address/RLE)

A data byte written to this address is placed in the FIFO and tagged as an ECP Address/RLE. The hardware at the ECP port transmits this byte to the peripheral automatically. The operation of this register is defined only for the forward direction. The bit definitions are as follows:

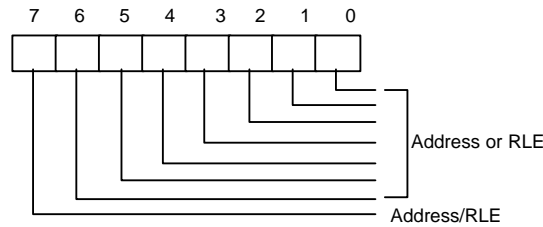

6.3.3 Device Status Register (DSR)

These bits are at low level during a read of the Printer Status Register. The bits of this status register are defined as follows:

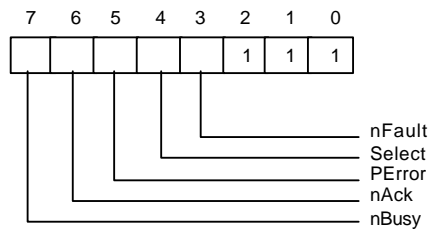

- Bit 7: This bit reflects the complement of the Busy input.
- Bit 6: This bit reflects the nAck input.
- Bit 5: This bit reflects the PError input.
- Bit 4: This bit reflects the Select input.
- Bit 3: This bit reflects the nFault input.
- Bit 2-0: These three bits are not implemented and are always logic one during a read.

6.3.4 Device Control Register (DCR)

The bit definitions are as follows:

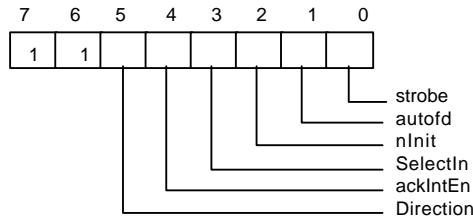

- Bit 6, 7: These two bits are logic one during a read and cannot be written.
- Bit 5: This bit has no effect and the direction is always out if mode = 000 or mode = 010. Direction is valid in all other modes.
 - 0 the parallel port is in output mode.
 - 1 the parallel port is in input mode.
- Bit 4: Interrupt request enable. When this bit is set to a high level, it may be used to enable interrupt requests from the parallel port to the CPU due to a low to high transition on the ACK# input.
- Bit 3: This bit is inverted and output to the SLIN# output.
 - 0 The printer is not selected.
 - 1 The printer is selected.
- Bit 2: This bit is output to the INIT# output.
- Bit 1: This bit is inverted and output to the AFD# output.
- Bit 0: This bit is inverted and output to the STB# output.

6.3.5 cFifo (Parallel Port Data FIFO) Mode = 010

This mode is defined only for the forward direction. The standard parallel port protocol is used by a hardware handshake to the peripheral to transmit bytes written or DMAed from the system to this FIFO. Transfers to the FIFO are byte aligned.

6.3.6 ecpDFifo (ECP Data FIFO) Mode = 011

When the direction bit is 0, bytes written or DMAed from the system to this FIFO are transmitted by a hardware handshake to the peripheral using the ECP parallel port protocol. Transfers to the FIFO are byte aligned.

When the direction bit is 1, data bytes from the peripheral are read under automatic hardware handshake from ECP into this FIFO. Reads or DMA's from the FIFO will return bytes of ECP data to the system.

6.3.7 tFifo (Test FIFO Mode) Mode = 110

Data bytes may be read, written, or DMAed to or from the system to this FIFO in any direction. Data in the tFIFO will not be transmitted to the parallel port lines. However, data in the tFIFO may be displayed on the parallel port data lines.

6.3.8 cnfgA (Configuration Register A) Mode = 111

This register is a read-only register. When it is read, 10H is returned. This indicates to the system that this is an 8-bit implementation.

6.3.9 cnfgB (Configuration Register B) Mode = 111

The bit definitions are as follows:

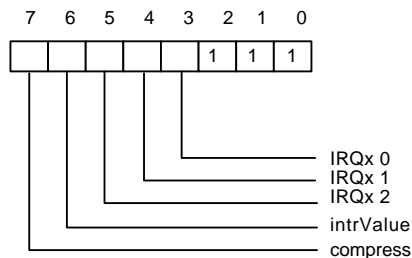

Bit 7: This bit is read-only. It is at low level during a read. This means that this chip does not support hardware RLE compression.

Bit 6: Returns the value on the ISA IRQ line to determine possible conflicts.



Bit 5-3: Reflect the IRQ resource assigned for ECP port.

cnfgB[5:3]	IRQ resource
000	reflect other IRQ resources selected by PnP register (default)
001	IRQ7
010	IRQ9
011	IRQ10
100	IRQ11
101	IRQ14
110	IRQ15
111	IRQ5

Bit 2-0: These five bits are at high level during a read and can be written .

6.3.10 ecr (Extended Control Register) Mode = all

This register controls the extended ECP parallel port functions. The bit definitions are follows:

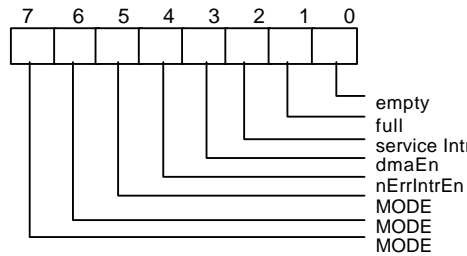

Bit 7-5: These bits are read/write and select the mode.

- 000 Standard Parallel Port mode. The FIFO is reset in this mode.
- 001 PS/2 Parallel Port mode. This is the same as 000 except that direction may be used to tri-state the data lines and reading the data register returns the value on the data lines and not the value in the data register.
- 010 Parallel Port FIFO mode. This is the same as 000 except that bytes are written or DMAed to the FIFO. FIFO data are automatically transmitted using the standard parallel port protocol. This mode is useful only when direction is 0.
- 011 ECP Parallel Port Mode. When the direction is 0 (forward direction), bytes placed into the ecpDFifo and bytes written to the ecpAFifo are placed in a single FIFO and auto transmitted to the peripheral using ECP Protocol. When the direction is 1 (reverse direction), bytes are moved from the ECP parallel port and packed into bytes in the ecpDFifo.
- 100 Selects EPP Mode. In this mode, EPP is activated if the EPP mode is selected.
- 101 Reserved.
- 110 Test Mode. The FIFO may be written and read in this mode, but the data will not be transmitted on the parallel port.
- 111 Configuration Mode. The cnfgA and cnfgB registers are accessible at 0x400 and 0x401 in this mode.



Bit 4: Read/Write (Valid only in ECP Mode)

- 1 Disables the interrupt generated on the asserting edge of nFault.
- 0 Enables an interrupt pulse on the high to low edge of nFault. If nFault is asserted (interrupt) an interrupt will be generated and this bit is written from a 1 to 0.

Bit 3: Read/Write

- 1 Enables DMA.
- 0 Disables DMA unconditionally.

Bit 2: Read/Write

- 1 Disables DMA and all of the service interrupts.
- 0 Enables one of the following cases of interrupts. When one of the service interrupts has occurred, the serviceIntr bit is set to a 1 by hardware. This bit must be reset to 0 to re-enable the interrupts. Writing a 1 to this bit will not cause an interrupt.
 - (a) dmaEn = 1: During DMA this bit is set to a 1 when terminal count is reached.
 - (b) dmaEn = 0 direction = 0: This bit is set to 1 whenever there are writeIntr Threshold or more bytes free in the FIFO.
 - (c) dmaEn = 0 direction = 1: This bit is set to 1 whenever there are readIntr Threshold or more valid bytes to be read from the FIFO.

Bit 1: Read only

- 0 The FIFO has at least 1 free byte.
- 1 The FIFO cannot accept another byte or the FIFO is completely full.

Bit 0: Read only

- 0 The FIFO contains at least 1 byte of data.
- 1 The FIFO is completely empty.

6.3.11 Bit Map of ECP Port Registers

	D7	D6	D5	D4	D3	D2	D1	D0	NOTE
data	PD7	PD6	PD5	PD4	PD3	PD2	PD1	PD0	
ecpAFifo	Addr/RLE	Address or RLE field							2
dsr	nBusy	nAck	PError	Select	nFault	1	1	1	1
dcr	1	1	Directio	ackIntrEn	SelectIn	nInit	autofd	strobe	1
cFifo	Parallel Port Data FIFO								2
ecpDFifo	ECP Data FIFO								2
tFifo	Test FIFO								2
cnfgA	0	0	0	1	0	0	0	0	
cnfgB	compress	intrValue	1	1	1	1	1	1	
ecr	MODE			nErrIntrEn	dmaEn	serviceIntr	full	empty	

Notes:

1. These registers are available in all modes.
2. All FIFOs use one common 16-byte FIFO.



6.3.12 ECP Pin Descriptions

NAME	TYPE	DESCRIPTION
nStrobe (HostClk)	O	The nStrobe registers data or address into the slave on the asserting edge during write operations. This signal handshakes with Busy.
PD<7:0>	I/O	These signals contains address or data or RLE data.
nAck (PeriphClk)	I	This signal indicates valid data driven by the peripheral when asserted. This signal handshakes with nAutoFd in reverse.
Busy (PeriphAck)	I	This signal deasserts to indicate that the peripheral can accept data. It indicates whether the data lines contain ECP command information or data in the reverse direction. When in reverse direction, normal data are transferred when Busy (PeriphAck) is high and an 8-bit command is transferred when it is low.
PError (nAckReverse)	I	This signal is used to acknowledge a change in the direction of the transfer (asserted = forward). The peripheral drives this signal low to acknowledge nReverseRequest. The host relies upon nAckReverse to determine when it is permitted to drive the data bus.
Select (Xflag)	I	Indicates printer on line.
nAutoFd (HostAck)	O	Requests a byte of data from the peripheral when it is asserted. This signal indicates whether the data lines contain ECP address or data in the forward direction. When in forward direction, normal data are transferred when nAutoFd (HostAck) is high and an 8-bit command is transferred when it is low.
nFault (nPeriphRequest)	I	Generates an error interrupt when it is asserted. This signal is valid only in the forward direction. The peripheral is permitted (but not required) to drive this pin low to request a reverse transfer during ECP Mode.
nInit (nReverseRequest)	O	This signal sets the transfer direction (asserted = reverse, deasserted = forward). This pin is driven low to place the channel in the reverse direction.
nSelectIn (ECPMode)	O	This signal is always deasserted in ECP mode.



6.3.13 ECP Operation

The host must negotiate on the parallel port to determine if the peripheral supports the ECP protocol before ECP operation. After negotiation, it is necessary to initialize some of the port bits. The following are required:

- (a) Set direction = 0, enabling the drivers.
- (b) Set strobe = 0, causing the nStrobe signal to default to the deasserted state.
- (c) Set autoFd = 0, causing the nAutoFd signal to default to the deasserted state.
- (d) Set mode = 011 (ECP Mode)

ECP address/RLE bytes or data bytes may be sent automatically by writing the ecpAFifo or ecpDFifo, respectively.

6.3.13.1 Mode Switching

Software will execute P1284 negotiation and all operation prior to a data transfer phase under programmed I/O control (mode 000 or 001). Hardware provides an automatic control line handshake, moving data between the FIFO and the ECP port only in the data transfer phase (mode 011 or 010).

If the port is in mode 000 or 001 it may switch to any other mode. If the port is not in mode 000 or 001 it can only be switched into mode 000 or 001. The direction can be changed only in mode 001.

When in extended forward mode, the software should wait for the FIFO to be empty before switching back to mode 000 or 001. In ECP reverse mode the software waits for all the data to be read from the FIFO before changing back to mode 000 or 001.

6.3.13.2 Command/Data

ECP mode allows the transfer of normal 8-bit data or 8-bit commands. In the forward direction, normal data are transferred when HostAck is high and an 8-bit command is transferred when HostAck is low. The most significant bits of the command indicate whether it is a run-length count (for compression) or a channel address.

In the reverse direction, normal data are transferred when PeriphAck is high and an 8-bit command is transferred when PeriphAck is low. The most significant bit of the command is always zero.

6.3.13.3 Data Compression

The W83627HF supports run length encoded (RLE) decompression in hardware and can transfer compressed data to a peripheral. Note that the odd (RLE) compression in hardware is not supported. In order to transfer data in ECP mode, the compression count is written to the ecpAFifo and the data byte is written to the ecpDFifo.

6.3.14 FIFO Operation

The FIFO threshold is set in configuration register 5. All data transfers to or from the parallel port can proceed in DMA or Programmed I/O (non-DMA) mode, as indicated by the selected mode. The FIFO is used by selecting the Parallel Port FIFO mode or ECP Parallel Port Mode. After a reset, the FIFO is disabled.



6.3.15 DMA Transfers

DMA transfers are always to or from the ecpDFifo, tFifo, or CFifo. The DMA uses the standard PC DMA services. The ECP requests DMA transfers from the host by activating the PDRQ pin. The DMA will empty or fill the FIFO using the appropriate direction and mode. When the terminal count in the DMA controller is reached, an interrupt is generated and serviceIntr is asserted, which will disable the DMA.

6.3.16 Programmed I/O (NON-DMA) Mode

The ECP or parallel port FIFOs can also be operated using interrupt driven programmed I/O. Programmed I/O transfers are to the ecpDFifo at 400H and ecpAFifo at 000H or from the ecpDFifo located at 400H, or to/from the tFifo at 400H. The host must set the direction, state, dmaEn = 0 and serviceIntr = 0 in the programmed I/O transfers.

The ECP requests programmed I/O transfers from the host by activating the IRQ pin. The programmed I/O will empty or fill the FIFO using the appropriate direction and mode.

6.4 Extension FDD Mode (EXTFDD)

In this mode, the W83627HF changes the printer interface pins to FDC input/output pins, allowing the user to install a second floppy disk drive (FDD B) through the DB-25 printer connector. The pin assignments for the FDC input/output pins are shown in Table 6-1.

After the printer interface is set to EXTFDD mode, the following occur:

- (1) Pins MOB# and DSB# will be forced to inactive state.
- (2) Pins DSKCHG#, RDATA#, WP#, TRAK0#, INDEX# will be logically ORed with pins PD4-PD0 to serve as input signals to the FDC.
- (3) Pins PD4-PD0 each will have an internal resistor of about 1K ohm to serve as pull-up resistor for FDD open drain/collector output.
- (4) If the parallel port is set to EXTFDD mode after the system has booted DOS or another operating system, a warm reset is needed to enable the system to recognize the extension floppy drive.

6.5 Extension 2FDD Mode (EXT2FDD)

In this mode, the W83627HF changes the printer interface pins to FDC input/output pins, allowing the user to install two external floppy disk drives through the DB-25 printer connector to replace internal floppy disk drives A and B. The pin assignments for the FDC input/output pins are shown in Table 6-1.

After the printer interface is set to EXTFDD mode, the following occur:

- (1) Pins MOA#, DSA#, MOB#, and DSB# will be forced to inactive state.
- (2) Pins DSKCHG#, RDATA#, WP#, TRAK0#, and INDEX# will be logically ORed with pins PD4-PD0 to serve as input signals to the FDC.
- (3) Pins PD4-PD0 each will have an internal resistor of about 1K ohm to serve as pull-up resistor for FDD open drain/collector output.
- (4) If the parallel port is set to EXT2FDD mode after the system has booted DOS or another operating system, a warm reset is needed to enable the system to recognize the extension floppy drive.



7. GENERAL PURPOSE I/O

W83697HF provides 24 input/output ports that can be individually configured to perform a simple basic I/O function or a pre-defined alternate function. Those 24 GP I/O ports are divided into three groups, each group contains 8 ports. The first group is configured through control registers in logical device 7, the second group in logical device 8, and the third group in logical device 9. Users can configure each individual port to be an input or output port by programming respective bit in selection register (CRF0: 0 = output, 1 = input). Invert port value by setting inversion register (CRF2: 0 = non-inverse, 1 = inverse). Port value is read/written through data register (CRF1). Table 7.1 and 7.2 gives more details on GPIO's assignment. In addition, GPIO1 is designed to be functional even in power loss condition (VCC or VSB is off). Figure 7.1 shows the GP I/O port's structure. Right after Power-on reset, those ports default to perform basic input function except ports in GPIO1 which maintains its previous settings until a battery loss condition.

Table 7.1

SELECTION BIT 0 = OUTPUT 1 = INPUT	INVERSION BIT 0 = NON INVERSE 1 = INVERSE	BASIC I/O OPERATIONS
0	0	Basic non-inverting output
0	1	Basic inverting output
1	0	Basic non-inverting input
1	1	Basic inverting input

Table 7.2

GP I/O PORT DATA REGISTER	REGISTER BIT ASSIGNMENT	GP I/O PORT
GP1	BIT 0	GP10
	BIT 1	GP11
	BIT 2	GP12
	BIT 3	GP13
	BIT 4	GP14
	BIT 5	GP15
	BIT 6	GP16
	BIT 7	GP17
GP2	BIT 0	GP20
	BIT 1	GP21
	BIT 2	GP22
	BIT 3	GP23
	BIT 4	GP24
	BIT 5	GP25
	BIT 6	GP26
	BIT 7	GP27
GP3	BIT 0	GP30
	BIT 1	GP31
	BIT 2	GP32
	BIT 3	GP33
	BIT 4	GP34
	BIT 5	GP35
	BIT 6	GP36
	BIT 7	GP37

8. ACPI REGISTERS FEATURES

W83697HF supports both ACPI and legacy power managements. The switch logic of the power management block generates an $\overline{\text{SMI}}$ interrupt in the legacy mode and an $\overline{\text{PME}}$ interrupt in the ACPI mode. The new ACPI feature routes $\overline{\text{SMI}} / \overline{\text{PME}}$ logic output either to $\overline{\text{SMI}}$ or to $\overline{\text{PME}}$. The $\overline{\text{SMI}} / \overline{\text{PME}}$ logic routes to $\overline{\text{SMI}}$ only when both $\text{PME_EN} = 0$ and $\text{SMIPME_OE} = 1$. Similarly, the $\overline{\text{SMI}} / \overline{\text{PME}}$ logic routes to $\overline{\text{PME}}$ only when both $\text{PME_EN} = 1$ and $\text{SMIPME_OE} = 1$.

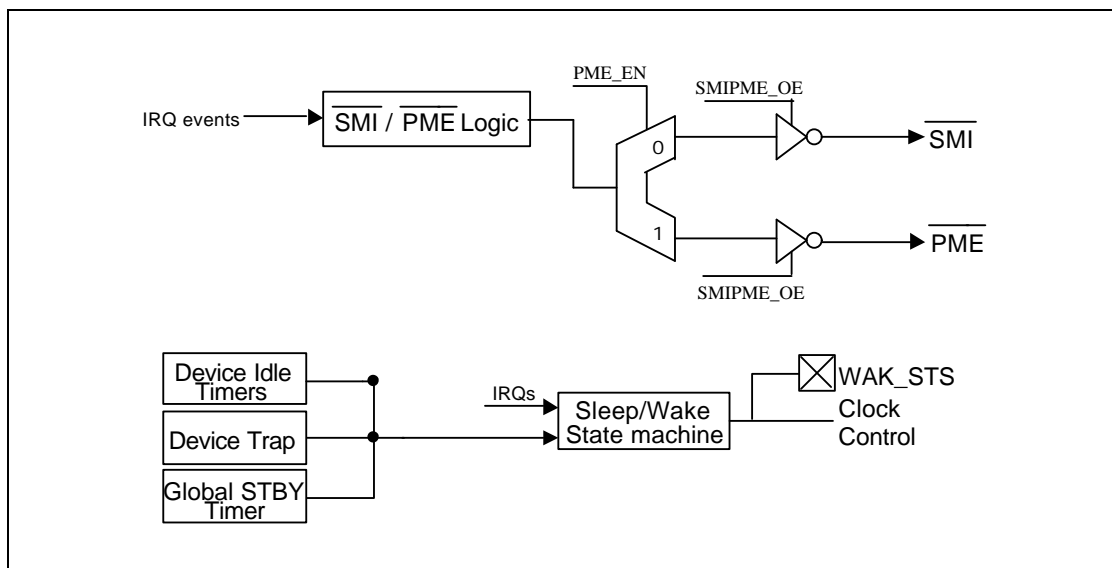



9. HARDWARE MONITOR

9.1 General Description

The W83697HF can be used to monitor several critical hardware parameters of the system, including power supply voltages, fan speeds, and temperatures, which are very important for a high-end computer system to work stable and properly. W83697HF provides LPC interface to access hardware .

An 8-bit analog-to-digital converter (ADC) was built inside W83697HF. The W83697HF can simultaneously monitor 7 analog voltage inputs, 2 fan tachometer inputs, 2 remote temperature, one case-open detection signal. The remote temperature sensing can be performed by thermistors, α 2N3904 NPN-type transistors, or directly from IntelTM Deschutes CPU thermal diode output. Also the W83697HF provides: 2 PWM (pulse width modulation) outputs for the fan speed control; beep tone output for warning; SMI#(through serial IRQ) , OVT#, GPO# signals for system protection events.

Through the application software or BIOS, the users can read all the monitored parameters of system from time to time. And a pop-up warning can be also activated when the monitored item was out of the proper/preset range. The application software could be Winbond's Hardware DoctorTM, or IntelTM LDCM (LanDesk Client Management), or other management application software. Also the users can set up the upper and lower limits (alarm thresholds) of these monitored parameters and to activate one programmable and maskable interrupts. An optional beep tone could be used as warning signal when the monitored parameters is out of the preset range.

9.2 Access Interface

The W83697HF provides two interface for microprocessor to read/write hardware monitor internal registers.

9.2.1 LPC interface

The first interface uses LPC Bus to access which the ports of low byte (bit2~bit0) are defined in the port 5h and 6h. The other higher bits of these ports is set by W83697HF itself. The general decoded address is set to port 295h and port 296h. These two ports are described as following:

Port 295h: Index port.

Port 296h: Data port.

The register structure is showed as the Figure 9.1

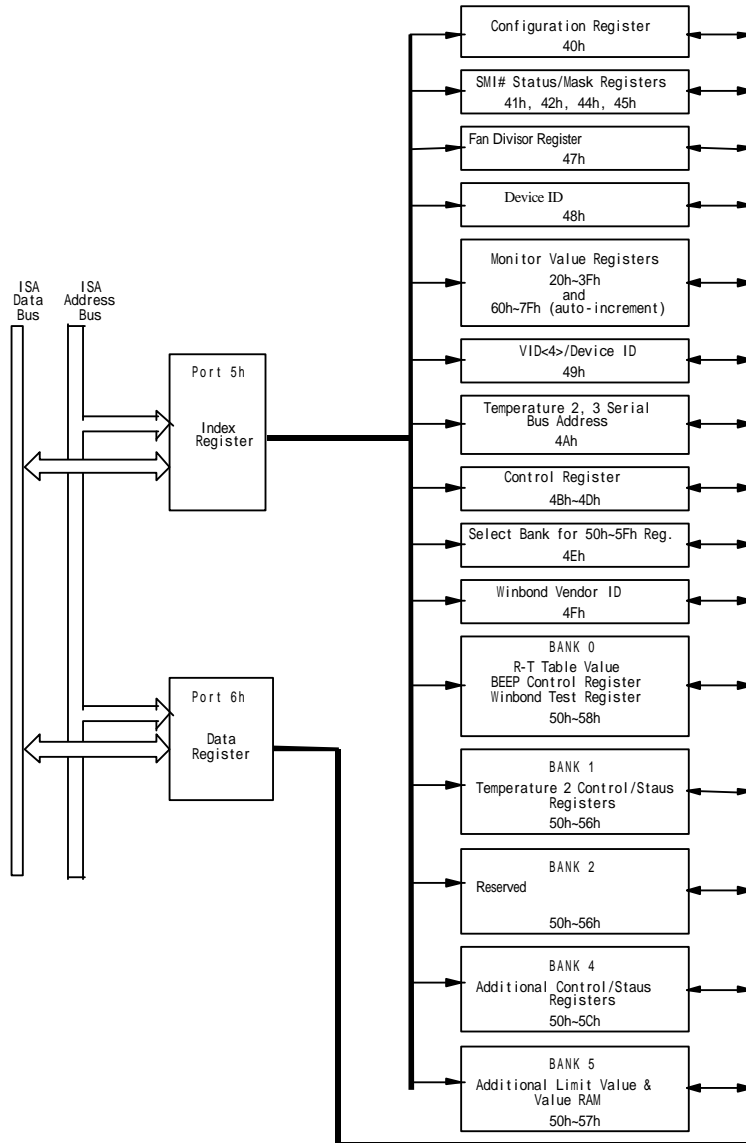

Figure 9.1 : ISA interface access diagram

9.3 Analog Inputs

The maximum input voltage of the analog pin is 4.096V because the 8-bit ADC has a 16mV LSB. Really, the application of the PC monitoring would most often be connected to power suppliers. The CPU V-core voltage ,+3.3V ,battery and 5VSB voltage can directly connected to these analog inputs. The +12V,-12V and -5V voltage inputs should be reduced a factor with external resistors so as to obtain the input range. As Figure 9.2 shows.

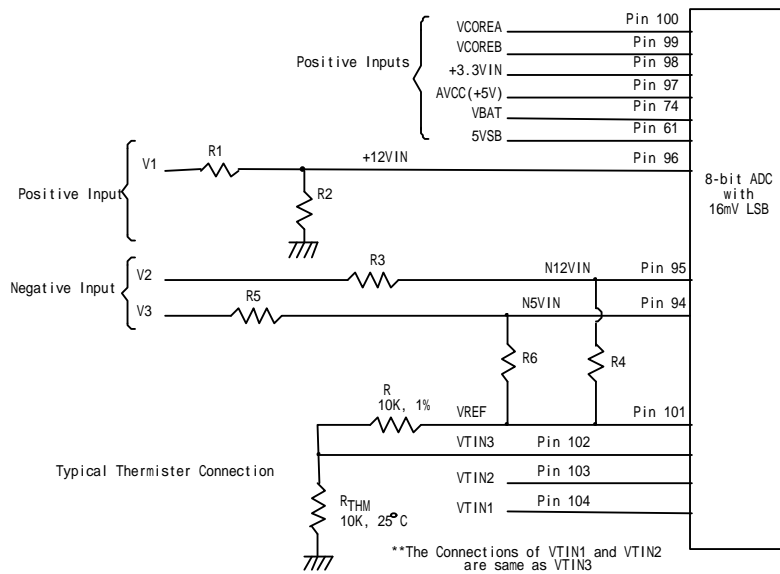

Figure. 9.2

9.3.1 Monitor over 4.096V voltage:

The input voltage +12VIN can be expressed as following equation.

$$12VIN = V_1 \times \frac{R_2}{R_1 + R_2}$$

The value of R1 and R2 can be selected to 28K Ohms and 10K Ohms, respectively, when the input voltage V1 is 12V. The node voltage of +12VIN can be subject to less than 4.096V for the maximum input range of the 8bit ADC. The Pin 97 is connected to the power supply VCC with +5V. There are two functions in this pin with 5V. The first function is to supply internal analog power in the W83697HF and the second function is that this voltage with 5V is connected to internal serial resistors to monitor the +5V voltage. The value of two serial resistors are 34K ohms and 50K ohms so that input voltage to ADC is 2.98V which is less than 4.096V of ADC maximum input voltage. The express equation can represent as follows.

$$V_{in} = VCC \times \frac{50K\Omega}{50K\Omega + 34K\Omega} \cong 2.98V$$

where VCC is set to 5V.

The Pin 61 is connected to 5VSB voltage. W83697HF monitors this voltage and the internal two serial resistors are 17K Ω and 33K Ω so that input voltage to ADC is 3.3V which less than 4.096V of ADC maximum input voltage.

9.3.2 Monitor negative voltage:

The negative voltage should be connected two series resistors and a positive voltage VREF (is equal to 3.6V). In the Figure 9.2, the voltage V2 and V3 are two negative voltage which they are -12V and -5V respectively. The voltage V2 is connected to two serial resistors then is connected to another terminal VREF which is positive voltage. So as that the voltage node N12VIN can be obtain a posedge voltage if the scales of the two serial resistors are carefully selected. It is recommended from Winbond that the scale of two serial resistors are R3=232K ohms and R4=56K ohm. The input voltage of node N12VIN can be calculated by following equation.

$$N12VIN = (VREF + |V_2|) \times \left(\frac{232K\Omega}{232K\Omega + 56K\Omega} \right) + V_2$$

where VREF is equal 3.6V.

If the V2 is equal to -12V then the voltage is equal to 0.567V and the converted hexadecimal data is set to 35h by the 8-bit ADC with 16mV-LSB. This monitored value should be converted to the real negative voltage and the express equation is shown as follows.

$$V_2 = \frac{N12VIN - VREF \times b}{1 - b}$$

Where β is 232K/(232K+56K). If the N2VIN is 0.567 then the V2 is approximately equal to -12V.

The another negative voltage input V3 (approximate -5V) also can be evaluated by the similar method and the serial resistors can be selected with R5=120K ohms and R6=56K ohms by the Winbond recommended. The expression equation of V3 With -5V voltage is shown as follows.

$$V_3 = \frac{N5VIN - VREF \times g}{1 - g}$$

Where the γ is set to 120K/(120K+56K). If the monitored ADC value in the N5VIN channel is 0.8635, VREF=3.6V and the parameter γ is 0.6818 then the negative voltage of V3 can be evaluated to be -5V.



9.3.3 Temperature Measurement Machine

The temperature data format is 8-bit two's-complement for sensor 1 and 9-bit two's-complement for sensor 2. The 8-bit temperature data can be obtained by reading the CR[27h]. The 9-bit temperature data can be obtained by reading the 8 MSBs from the Bank1 CR[50h] and the LSB from the Bank1 CR[51h] bit 7. The format of the temperature data is show in Table 1.

Temperature	8-Bit Digital Output		9-Bit Digital Output	
	8-Bit Binary	8-Bit Hex	9-Bit Binary	9-Bit Hex
+125°C	0111,1101	7Dh	0,1111,1010	0FAh
+25°C	0001,1001	19h	0,0011,0010	032h
+1°C	0000,0001	01h	0,0000,0010	002h
+0.5°C	-	-	0,0000,0001	001h
+0°C	0000,0000	00h	0,0000,0000	000h
-0.5°C	-	-	1,1111,1111	1FFh
-1°C	1111,1111	FFh	1,1111,1110	1FFh
-25°C	1110,0111	E7h	1,1100,1110	1CEh
-55°C	1100,1001	C9h	1,1001,0010	192h

Table 2.

9.3.3.1 Monitor temperature from thermistor:

The W83697HF can connect three thermistors to measure three different envirmnt temperature. The specification of thermistor should be considered to (1) β value is 3435K, (2) resistor value is 10K ohms at 25°C. In the Figure 9.2, the themistor is connected by a serial resistor with 10K Ohms, then connect to VREF (Pin 101).

9.3.3.2 Monitor temperature from Pentium II™ thermal diode or bipolar transistor 2N3904

The W83697HF can alternate the thermistor to Pentium II™ (Deschutes) thermal diode interface or transistor 2N3904 and the circuit connection is shown as Figure 9.3. The pin of Pentium II™ D- is connected to power supply ground (GND) and the pin D+ is connected to pin VTINx in the W83697HF. The resistor R=30K ohms should be connected to VREF to supply the diode bias current and the bypass capacitor C=3300pF should be added to filter the high frequency noise. The transistor 2N3904 should be connected to a form with a diode, that is, the Base (B) and Collector (C) in the 2N3904 should be tied together to act as a thermal diode.

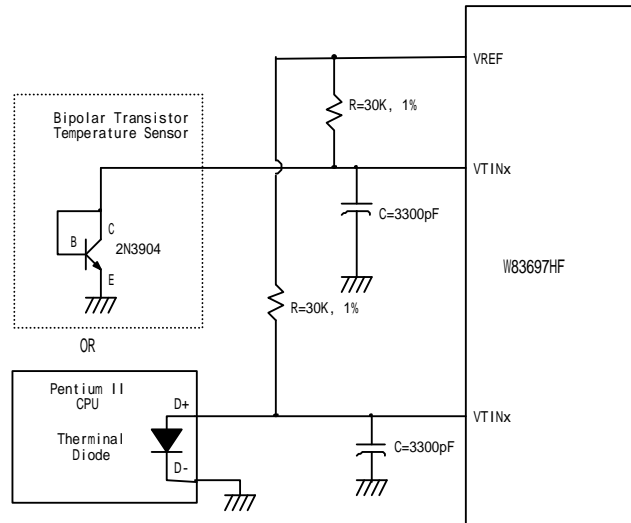

Figure 9.3

9.4 FAN Speed Count and FAN Speed Control

9.4.1 Fan speed count

Inputs are provided for signals from fans equipped with tachometer outputs. The level of these signals should be set to TTL level, and maximum input voltage can not be over +5.5V. If the input signals from the tachometer outputs are over the VCC, the external trimming circuit should be added to reduce the voltage to obtain the input specification. The normal circuit and trimming circuits are shown as Figure 9.4.

Determine the fan counter according to:

$$\text{Count} = \frac{1.35 \times 10^6}{\text{RPM} \times \text{Divisor}}$$

In other words, the fan speed counter has been read from register CR28 or CR29 or CR2A, the fan speed can be evaluated by the following equation.

$$\text{RPM} = \frac{1.35 \times 10^6}{\text{Count} \times \text{Divisor}}$$

The default divisor is 2 and defined at CR47.bit7~4, and Bank0 CR5D.bit5~7 which are three bits for divisor. That provides very low speed fan counter such as power supply fan. The followed table is an example for the relation of divisor, PRM, and count.

Divisor	Nominal PRM	Time per Revolution	Counts	70% RPM	Time for 70%
1	8800	6.82 ms	153	6160	9.74 ms
2 (default)	4400	13.64 ms	153	3080	19.48 ms
4	2200	27.27 ms	153	1540	38.96 ms
8	1100	54.54 ms	153	770	77.92 ms
16	550	109.08 ms	153	385	155.84 ms
32	275	218.16 ms	153	192	311.68 ms
64	137	436.32 ms	153	96	623.36 ms
128	68	872.64 ms	153	48	1246.72 ms

Table 1.

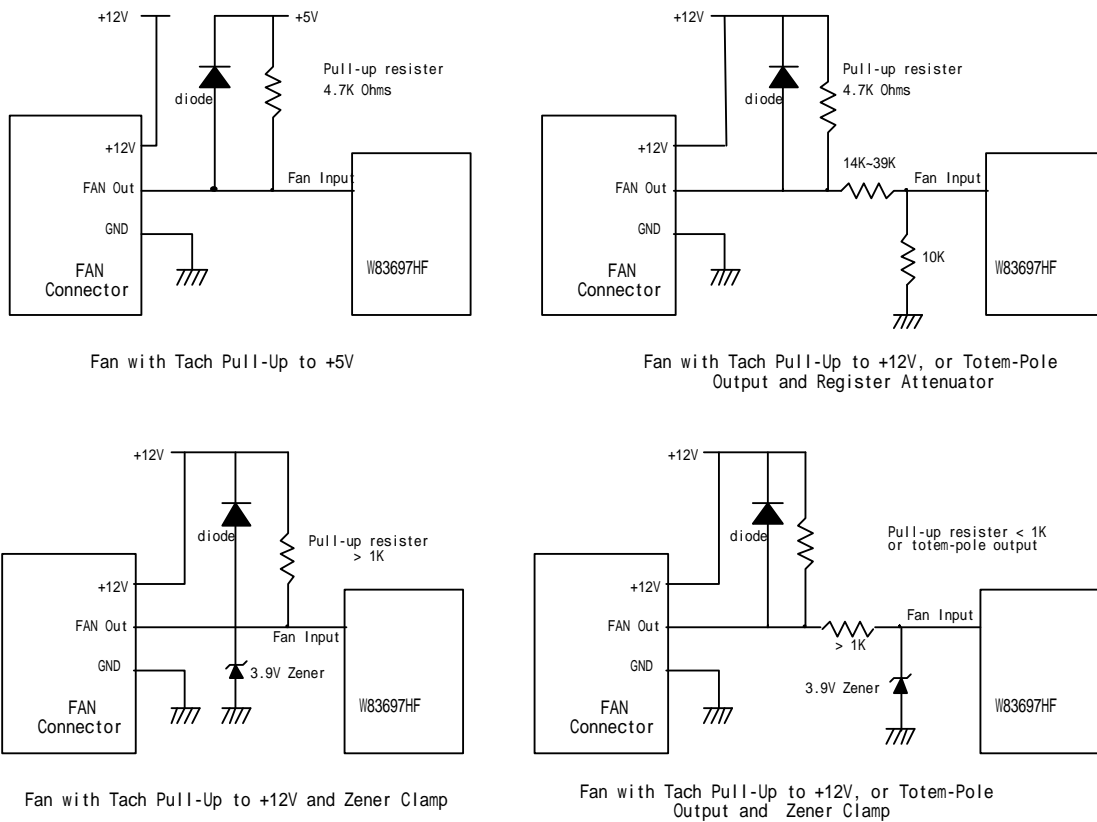

Figure 9.4

Publication Release Date: Feb. 2002
Revision 0.70

9.4.2 Fan speed control

The W83697HF provides 2 sets for fan PWM speed control. The duty cycle of PWM can be programmed by a 8-bit registers which are defined in the Bank0 CR5A and CR5B. The default duty cycle is set to 100%, that is, the default 8-bit registers is set to FFh. The expression of duty can be represented as follows.

$$\text{Duty - cycle(\%)} = \frac{\text{Programmed 8 - bit Register Value}}{255} \times 100\%$$

The PWM clock frequency also can be program and defined in the Bank0.CR5C . The application circuit is shown as follows.

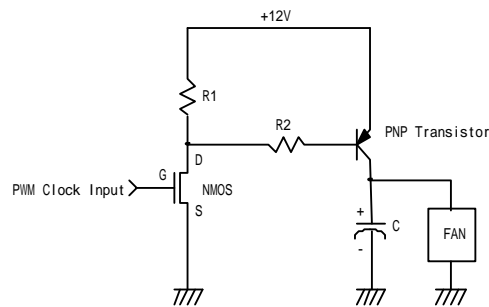

Figure 9.5

9.5 SMI# interrupt mode

9.5.1 Voltage SMI# mode :

SMI# interrupt for voltage is Two-Times Interrupt Mode. Voltage exceeding high limit or going below low limit will causes an interrupt if the previous interrupt has been reset by reading all the interrupt Status Register. (Figure 9.6)

9.5.2 Fan SMI# mode :

SMI# interrupt for fan is Two-Times Interrupt Mode. Fan count exceeding the limit, or exceeding and then going below the limit, will causes an interrupt if the previous interrupt has been reset by reading all the interrupt Status Register. (Figure 9.7)

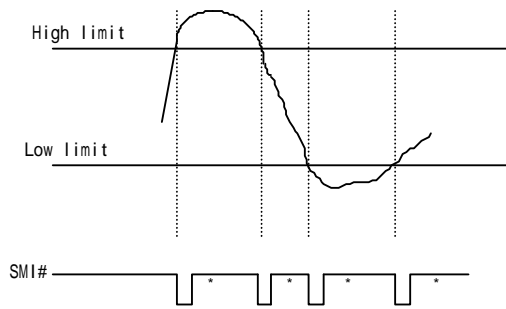

*Interrupt Reset when Interrupt Status Registers are read

Figure 9.6

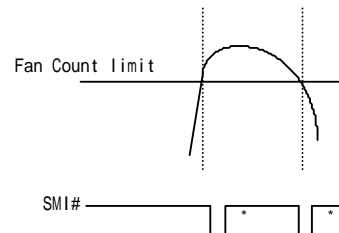

Figure 9.7

9.5.3 The W83697HF temperature sensor 1 SMI# interrupt has two modes:

(1) Comparator Interrupt Mode

Setting the T_{HYST} (Temperature Hysteresis) limit to 127°C will set temperature sensor 1 SMI# to the Comparator Interrupt Mode. Temperature exceeds T_O (Over Temperature) Limit causes an interrupt and this interrupt will be reset by reading all the Interrupt Status Register. Once an interrupt event has occurred by exceeding T_O , then reset, if the temperature remains above the T_O , the interrupt will occur again when the next conversion has completed. If an interrupt event has occurred by exceeding T_O and not reset, the interrupts will not occur again. The interrupts will continue to occur in this manner until the temperature goes below T_O . (Figure 9.8)

(2) Two-Times Interrupt Mode

Setting the T_{HYST} lower than T_O will set temperature sensor 1 SMI# to the Two-Times Interrupt Mode. Temperature exceeding T_O causes an interrupt and then temperature going below T_{HYST} will also cause an interrupt if the previous interrupt has been reset by reading all the interrupt Status Register. Once an interrupt event has occurred by exceeding T_O , then reset, if the temperature remains above the T_{HYST} , the interrupt will not occur. (Figure 9.9)

(3) One-Time Interrupt Mode

Temperature exceeding T_O causes an interrupt and then temperature going below T_{HYST} will not cause an interrupt. Once an interrupt event has occurred by exceeding T_O , then going below T_{HYST} an interrupt will not occur again until the temperature exceeding T_O . (Figure 9.9)

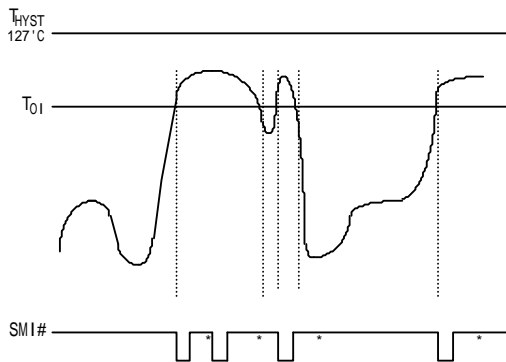

Figure 9.8

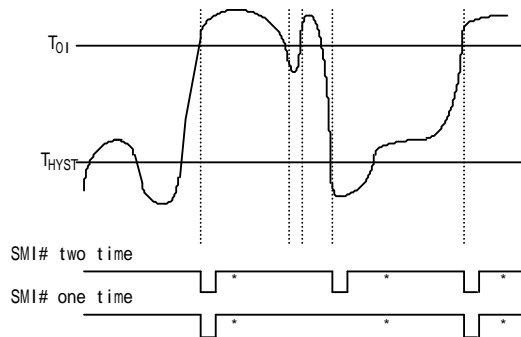

Figure 9.9

*Interrupt Reset when Interrupt Status Registers are read

9.5.4 The W83697HF temperature sensor 2 SMI# interrupt has two modes and it is programmed at CR[4Ch] bit 6.

(1) Comparator Interrupt Mode:

Temperature exceeding T_0 causes an interrupt and this interrupt will be reset by reading all the Interrupt Status Register. Once an interrupt event has occurred by exceeding T_0 , then reset, if the temperature remains above the T_{HYST} , the interrupt will occur again when the next conversion has completed. If an interrupt event has occurred by exceeding T_0 and not reset, the interrupts will not occur again. The interrupts will continue to occur in this manner until the temperature goes below T_{HYST} . (Figure 9.10)

(2) Two-Times Interrupt Mode(Default):

Temperature exceeding T_0 causes an interrupt and then temperature going below T_{HYST} will also cause an interrupt if the previous interrupt has been reset by reading all the interrupt Status Register. Once an interrupt event has occurred by exceeding T_0 , then reset, if the temperature remains above the T_{HYST} , the interrupt will not occur. (Figure 9.11)

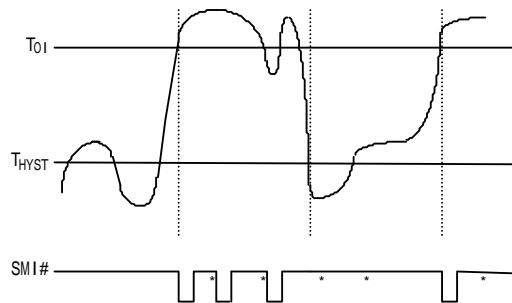

Figure 9.10

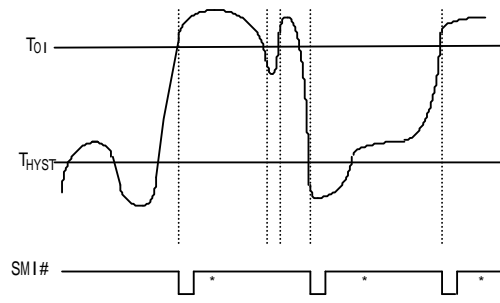

Figure 9.11

*Interrupt Reset when Interrupt Status Registers are read

9.6 OVT# interrupt mode

The OVT# signal is only related with temperature sensor 2.

9.6.1 The W83697HF temperature sensor 2 Over-Temperature (OVT#) has the following modes

(1) Comparator Mode(Default):

Setting Bank1/2 CR[52h] bit 2 to 0 will set OVT# signal to comparator mode. Temperature exceeding T_O causes the OVT# output activated until the temperature is less than T_{HYST} . (Figure 9.12)

(2) Interrupt Mode:

Setting Bank1/2 CR[52h] bit 2 to 1 will set OVT# signal to interrupt mode. Setting Temperature exceeding T_O causes the OVT# output activated indefinitely until reset by reading temperature sensor 2 or sensor 3 registers. Temperature exceeding T_O , then OVT# reset, and then temperature going below T_{HYST} will also cause the OVT# activated indefinitely until reset by reading temperature sensor2 or sensor 3 registers. Once the OVT# is activated by exceeding T_O , then reset, if the temperature remains above T_{HYST} , the OVT# will not be activated again.(Figure 9.12)

Temperature sensor 2 and 3 Over-Temperature output (OVT#) in ACPI mode

Setting CR[4Ch] bit 1 to 1 will set OVT# signal to ACPI mode. At this mode, temperature exceeding one level of temperature separation, starting from 0 degree, causes the OVT# output activated. OVT# will be activated again once temperature exceeding the next level. OVT# output will act the same manner when temperature goes down. (Figure 17,18). If temperature goes around the current level, the OVT# will not act.(Refer the arrow in the figure). The granularity of temperature separation between each OVT# output signal can be programmed at Bank0 CR[5Fh].

The priority of this mode is higher than Comparator mode and Interrupt mode .

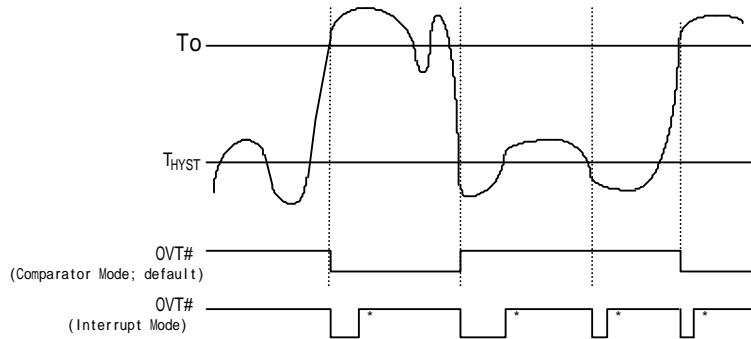

*Interrupt Reset when Temperature 2/3 is read

OVT# pin signal in ACPI mode

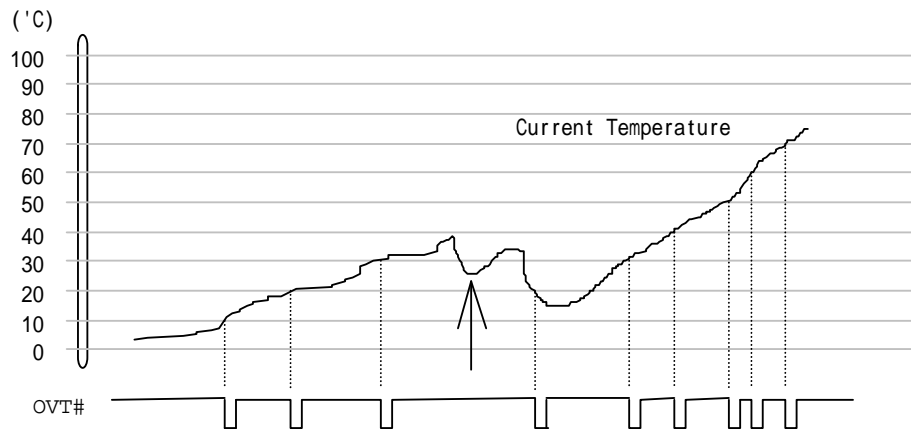



9.7 REGISTERS AND RAM

9.7.1 Address Register (Port x5h)

Data Port: Port x5h
 Power on Default Value: 00h
 Attribute: Bit 6:0 Read/write , Bit 7: Read Only
 Size: 8 bits

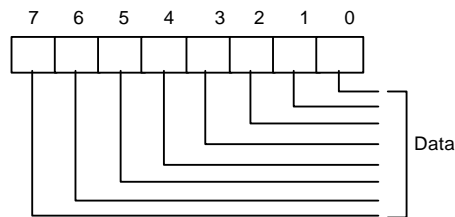

Bit7: Read Only

The logical 1 indicates the device is busy because of a Serial Bus transaction or another LPC bus transaction. With checking this bit, multiple LPC drivers can use W83697HF hardware monitor without interfering with each other or a Serial Bus driver.

It is the user's responsibility not to have a Serial Bus and LPC bus operations at the same time.

This bit is:

Set: with a write to Port x5h or when a Serial Bus transaction is in progress.

Reset: with a write or read from Port x6h if it is set by a write to Port x5h.

Bit 6-0: Read/Write

Bit 7	Bit 6	Bit 5	Bit 4	Bit 3	Bit 2	Bit 1	Bit 0
Busy (Power On default 0)	Address Pointer (Power On default 00h)						
	A6	A5	A4	A3	A2	A1	A0



Address Pointer Index (A6-A0)

Registers and RAM	A6-A0 in Hex	Power On Value of Registers: <k7:0>in Binary	Notes
Configuration Register	40h	00001000	
Interrupt Status Register 1	41h	00000000	Auto-increment to the address of Interrupt Status Register 2 after a read or write to Port x6h.
Interrupt Status Register 2	42h	00000000	
SMI#Y Mask Register 1	43h	00000000	Auto-increment to the address of SMIY Mask Register 2 after a read or write to Port x6h.
SMIY Mask Register 2	44h	00000000	
NMI Mask Register 1	45h	00000000	Auto-increment to the address of NMI Mask Register 2 after a read or write to Port x6h
NMI Mask Register 2	46h	01000000	
Fan Divisor Register	47h	<7:4> = 0101;	
Reserved	48h		
Device ID Register	49h	<7:1> = 0000001	
Reserved	4Ah		
Reserved	4Bh		
SMI#/OVT# Property Select Register	4Ch	<7:0> = 00000000	
FAN IN/OUT and BEEP Control Register	4Dh	<7:0> = 00010101	
Register 50h-5Fh Bank Select Register	4Eh	<7> = 1 ; <6:3> = Reserved ; <2:0> = 000	
Winbond Vendor ID Register	4Fh	<7:0> = 01011100 (High Byte) <7:0> = 10100011 (Low Byte)	



Address Pointer Index (A6-A0), continued

Registers and RAM	A6-A0 in Hex	Power On Value of Registers: <k7:0>in Binary	Notes
POST RAM	00-1Fh		Auto-increment to the next location after a read or write to Port x6h and stop at 1Fh.
Value RAM	20-3Fh		
Value RAM	60-7Fh		Auto-increment to the next location after a read or write to Port x6h and stop at 7Fh.
Temperature 2 Registers	Bank1 50h-56h		
Reserved	Bank2 50h-56h		
Additional Configuration Registers	Bank4 50h-5Dh		

9.7.2 Data Register (Port x6h)

Data Port: Port x6h
 Power on Default Value: 00h
 Attribute: Read/write
 Size: 8 bits

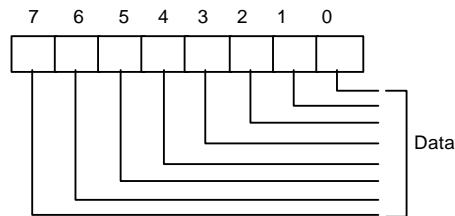

Bit 7-0: Data to be read from or to be written to RAM and Register.

9.7.3 Configuration Register ^{3/4} Index 40h

Register Location: 40h
 Power on Default Value: 01h
 Attribute: Read/write
 Size: 8 bits

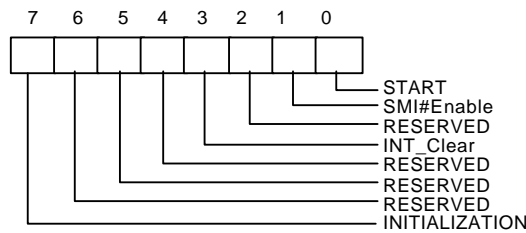

Bit 7: A one restores power on default value to all registers except the Serial Bus Address register. This bit clears itself since the power on default is zero.

Bit 6: Reserced

Bit 5: Reserved

Bit 4: Reserved

Bit 3: A one disables the SMI# output without affecting the contents of Interrupt Status Registers. The device will stop monitoring. It will resume upon clearing of this bit.

Bit 2: Reserved

Bit 1: A one enables the SMI# Interrupt output.

Bit 0: A one enables startup of monitoring operations, a zero puts the part in standby mode.

Note: The outputs of Interrupt pins will not be cleared if the user writes a zero to this location after an interrupt has occurred unlike "INT_Clear" bit.



9.7.4 Interrupt Status Register 1^{3/4} Index 41h

Register Location: 41h
 Power on Default Value 00h
 Attribute: Read Only
 Size: 8 bits

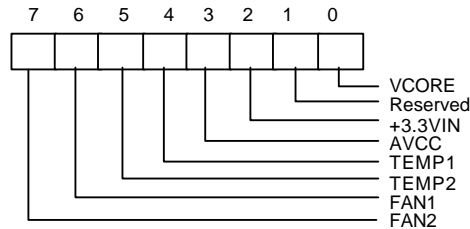

- Bit 7: A one indicates the fan count limit of FAN2 has been exceeded.
- Bit 6: A one indicates the fan count limit of FAN1 has been exceeded.
- Bit 5: A one indicates a High limit of VTIN2 has been exceeded from temperature sensor 2.
- Bit 4: A one indicates a High limit of VTIN1 has been exceeded from temperature sensor 1.
- Bit 3: A one indicates a High or Low limit of +5VIN has been exceeded.
- Bit 2: A one indicates a High or Low limit of +3.3VIN has been exceeded.
- Bit 1: Reserved
- Bit 0: A one indicates a High or Low limit of VCORE has been exceeded.

9.7.5 Interrupt Status Register 2^{3/4} Index 42h

Register Location: 42h
 Power on Default Value 00h
 Attribute: Read Only
 Size: 8 bits

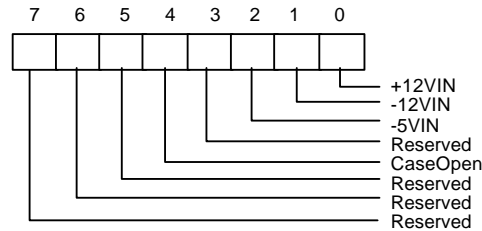

- Bit 7-6: Reserved. This bit should be set to 0.
- Bit 5: Reserved.
- Bit 4: A one indicates case has been opened.
- Bit 3: Reserved.
- Bit 2: A one indicates a High or Low limit of -5VIN has been exceeded.
- Bit 1: A one indicates a High or Low limit of -12VIN has been exceeded.
- Bit 0: A one indicates a High or Low limit of +12VIN has been exceeded.

9.7.6 SMI# Mask Register 1 ³/₄ Index 43h

Register Location: 43h
 Power on Default Value 00h
 Attribute: Read/Write
 Size: 8 bits

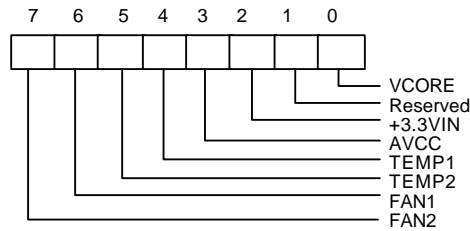

Bit 7-0: A one disables the corresponding interrupt status bit for $\overline{\text{SMI}}$ interrupt.

9.7.7 SMI# Mask Register 2 ³/₄ Index 44h

Register Location: 44h
 Power on Default Value 00h
 Attribute: Read/Write
 Size: 8 bits

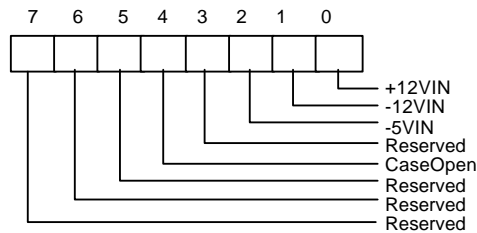

Bit 7-6: Reserved. This bit should be set to 0.
 Bit 5-0: A one disables the corresponding interrupt status bit for $\overline{\text{SMI}}$ interrupt.



9.7.8 Reserved Register ³/₄ Index 45h

9.7.9 Chassis Clear Register -- Index 46h

Register Location: 46h
 Power on Default Value 00h
 Attribute: Read/Write
 Size: 8 bits

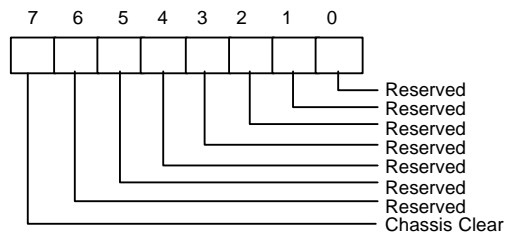

Bit 7: Set 1 , clear case open event. This bit self clears after clearing case open event.
 Bit 6-0:Reserved. This bit should be set to 0.

9.7.10 Fan Divisor Register ³/₄ Index 47h

Register Location: 47h
 Power on Default Value
 Attribute: Read/Write
 Size: 8 bits

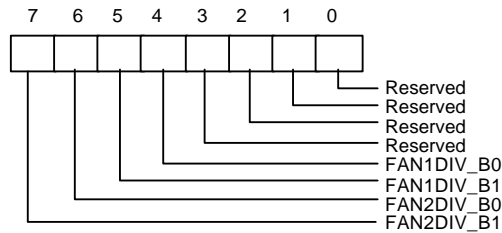

Bit 7-6: FAN2 Speed Control.
 Bit 5-4: FAN1 Speed Control.
 Bit 3-0: Reserved
 Note : Please refer to Bank0 CR[5Dh] , Fan divisor table.

9.7.11 Value RAM $\frac{3}{4}$ Index 20h- 3Fh or 60h - 7Fh (auto-increment)

Address A6-A0	Address A6-A0 with Auto-Increment	Description
20h	60h	VCORE reading
21h	61h	Reserved
22h	62h	+3.3VIN reading
23h	63h	AVCC(+5V) reading
24h	64h	+12VIN reading
25h	65h	-12VIN reading
26h	66h	-5VIN reading
27h	67h	Temperature sensor 1 reading
28h	68h	FAN1 reading Note: This location stores the number of counts of the internal clock per revolution.
29h	69h	FAN2 reading Note: This location stores the number of counts of the internal clock per revolution.
2Ah	6Ah	FAN3 reading Note: This location stores the number of counts of the internal clock per revolution.
2Bh	6Bh	VCORE High Limit
2Ch	6Ch	VCORE Low Limit
2Dh	6Dh	Reserved
2Eh	6Eh	Reserved
2Fh	6Fh	+3.3VIN High Limit
30h	70h	+3.3VIN Low Limit
31h	71h	AVCC(+5V) High Limit
32h	72h	AVCC(+5V) Low Limit
33h	73h	+12VIN High Limit
34h	74h	+12VIN Low Limit
35h	75h	-12VIN High Limit



9.7.11 Value RAM — Index 20h- 3Fh or 60h - 7Fh (auto-increment), continued

Address A6-A0	Address A6-A0 with Auto-Increment	Description
36h	76h	-12VIN Low Limit
37h	77h	-5VIN High Limit
38h	78h	-5VIN Low Limit
39h	79h	Temperature sensor 1 (VTIN1) High Limit
3Ah	7Ah	Temperature sensor 1 (VTIN1) Hysteresis Limit
3Bh	7Bh	FAN1 Fan Count Limit Note: It is the number of counts of the internal clock for the Low Limit of the fan speed.
3Ch	7Ch	FAN2 Fan Count Limit Note: It is the number of counts of the internal clock for the Low Limit of the fan speed.
3Dh	7Dh	Reserved.
3E- 3Fh	7E- 7Fh	Reserved

Setting all ones to the high limits for voltages and fans (0111 1111 binary for temperature) means interrupts will never be generated except the case when voltages go below the low limits.

9.7.12 Device ID Register - Index 49h

Register Location: 49h
 Power on Default Value <7:1> is 000,0002 binary
 Size: 8 bits

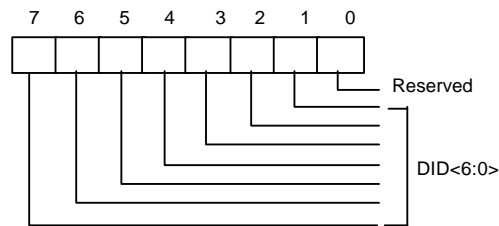

Bit 7-1: Read Only - Device ID<6:0>

Bit 0 : Reserved



9.7.13 Reserved - Index 4Bh



9.7.14 SMI#/OVT# Property Select Register- Index 4Ch

Register Location: 4Ch
 Power on Default Value 00h
 Attribute: Read/Write
 Size: 8 bits

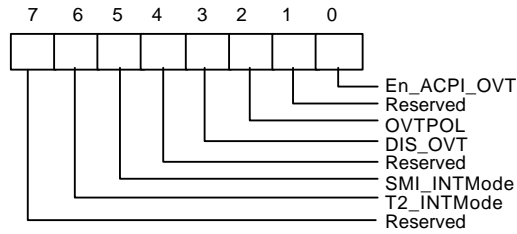

- Bit 7: Reserved. User Defined.
- Bit6: Set to 1, the SMI# output type of Temperature 2(VTIN2) is set to Comparator Interrupt mode. Set to 0, the SMI# output type is set to Two-Times Interrupt mode. (default 0)
- Bit5: This bit will be worked, when bit 6 set to 0. Set to 1, the interrupt mode is One time interrupt. Set to 0, the interrupt mode is two times interrupt.
- Bit 4: Reserved
- Bit 3: Disable temperature sensor 2 over-temperature (OVT) output if set to 1. Default 0, enable OVT1 output through pin OVT#.
- Bit 2: Over-temperature polarity. Write 1, OVT# active high. Write 0, OVT# active low. Default 0.
- Bit 1: Reserved.
- Bit 0: Reserved.

9.7.15 FAN IN/OUT and BEEP Control Register- Index 4Dh

Register Location: 4Dh
 Power on Default Value 15h
 Attribute: Read/Write
 Size: 8 bits

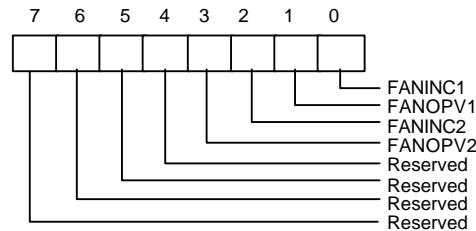

Bit 7~4: Reserved.

Bit 3: FAN 2 output value if FANINC2 sets to 0. Write 1, then pin 113 always generate logic high signal. Write 0, pin 113 always generates logic low signal. This bit default 0.

Bit 2: FAN 2 Input Control. Set to 1, pin 113 acts as FAN clock input, which is default value. Set to 0, this pin 113 acts as FAN control signal and the output value of FAN control is set by this register bit 3.

Bit 1: FAN 1 output value if FANINC1 sets to 0. Write 1, then pin 114 always generate logic high signal. Write 0, pin 114 always generates logic low signal. This bit default 0.

Bit 0: FAN 1 Input Control. Set to 1, pin 114 acts as FAN clock input, which is default value. Set to 0, this pin 114 acts as FAN control signal and the output value of FAN control is set by this register bit 1.

9.7.16 Register 50h ~ 5Fh Bank Select Register - Index 4Eh

Register Location: 4Eh

Power on Default Value 80h

Attribute: Read/Write

Size: 8 bits

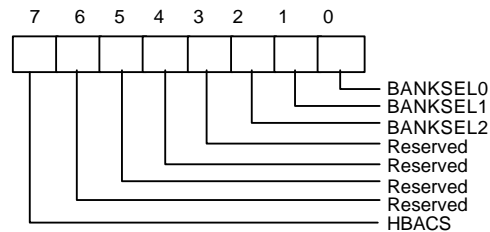

Bit 7: HBACS- High byte access. Set to 1, access Register 4Fh high byte register.

Set to 0, access Register 4Fh low byte register. Default 1.

Bit 6-3: Reserved. This bit should be set to 0.

Bit 2-0: Index ports 0x50~0x5F Bank select.



9.7.17 Winbond Vendor ID Register - Index 4Fh (No Auto Increase)

Register Location: 4Fh
 Power on Default Value <15:0> = 5CA3h
 Attribute: Read Only
 Size: 16 bits

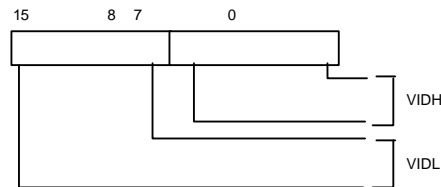

Bit 15-8: Vendor ID High Byte if CR4E.bit7=1. Default 5Ch.

Bit 7-0: Vendor ID Low Byte if CR4E.bit7=0. Default A3h.

9.7.18 Winbond Test Register -- Index 50h - 55h (Bank 0)

9.7.19 BEEP Control Register 1-- Index 56h (Bank 0)

Register Location: 56h
 Power on Default Value 00h
 Attribute: Read/Write
 Size: 8 bits

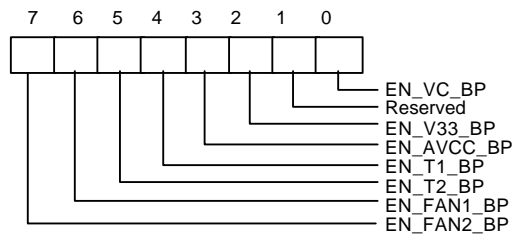

Bit 7: Enable BEEP Output from FAN 2 if the monitor value exceed the limit value. Write 1, enable BEEP output, which is default value.

Bit 6: Enable BEEP Output from FAN 1 if the monitor value exceed the limit value. Write 1, enable BEEP output, which is default value.



Bit 5: Enable BEEP Output from Temperature Sensor 2 if the monitor value exceed the limit value.
Write 1, enable BEEP output. Default 0



- Bit 4: Enable BEEP output for Temperature Sensor 1 if the monitor value exceed the limit value. Write 1, enable BEEP output. Default 0
- Bit 3: Enable BEEP output from AVCC (+5V), Write 1, enable BEEP output if the monitor value exceed the limits value. Default 0, that is disable BEEP output.
- Bit 2: Enable BEEP output from +3.3V. Write 1, enable BEEP output, which is default value.
- Bit 1: Reserved
- Bit 0: Enable BEEP Output from VCORE if the monitor value exceed the limits value. Write 1, enable BEEP output, which is default value

9.7.20 BEEP Control Register 2- Index 57h (Bank 0)

Register Location: 57h

Power on Default Value 80h

Attribute: Read/Write

Size: 8 bits

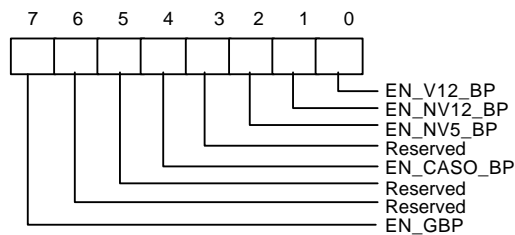

- Bit 7: Enable Global BEEP. Write 1, enable global BEEP output. Default 1. Write 0, disable all BEEP output.
- Bit 6: Reserved. This bit should be set to 0.
- Bit 5: Reserved
- Bit 4: Enable BEEP output for case open if case opened. Write 1, enable BEEP output. Default 0.
- Bit 3: Reserved
- Bit 2: Enable BEEP output from -5V, Write 1, enable BEEP output if the monitor value exceed the limits value. Default 0, that is disable BEEP output.
- Bit 1: Enable BEEP output from -12V, Write 1, enable BEEP output if the monitor value exceed the limits value. Default 0, that is disable BEEP output.
- Bit 0: Enable BEEP output from +12V, Write 1, enable BEEP output if the monitor value exceed the limits value. Default 0, that is disable BEEP output.



9.7.21 Chip ID – Index 58h (Bank 0)

Register Location: 58h
 Power on Default Value 60h
 Attribute: Read Only
 Size: 8 bits

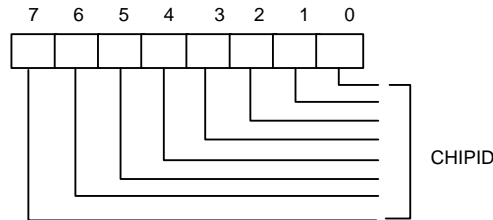

Bit 7: Winbond Chip ID number. Read this register will return 60h.

9.7.22 Reserved Register -- Index 59h (Bank 0)

Register Location: 59h
 Power on Default Value <7>=0 and <6:4> = 111 and <3:0> = 0000
 Attribute: Read/Write
 Size: 8 bits

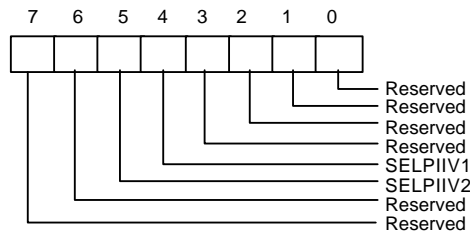

Bit 7-6: Reserved

Bit 5: Temperature sensor diode 2. Set to 1, select CPU compatible Diode. Set to 0 to select 2N3904 Bipolar mode.

Bit 4: Temperature sensor diode 1. Set to 1, select CPU compatible Diode. Set to 0 to select 2N3904 Bipolar mode.

Bit 3-0: Reserved



9.7.23 Reserved -- Index 5Ah (Bank 0)

9.7.24 Reserved -- Index 5Bh (Bank 0)

9.7.25 Reserved -- Index 5Ch (Bank 0)

9.7.26 VBAT Monitor Control Register -- Index 5Dh (Bank 0)

Register Location: 5Dh
 Power on Default Value 00h
 Attribute: Read/Write
 Size: 8 bits

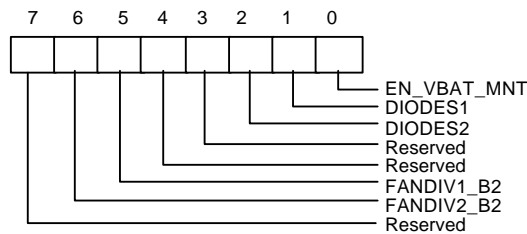

- Bit 7: Reserved.
- Bit 6: Fan2 divisor Bit 2.
- Bit 5: Fan1 divisor Bit 2.
- Bit 4 –3 : Reserved.
- Bit 2: Sensor 2 type selection. Set to 1, select bipolar sensor. Set to 0, select thermistor sensor.
- Bit 1: Sensor 1 type selection. Set to 1, select bipolar sensor. Set to 0, select thermistor sensor.
- Bit 0: Set to 1, enable battery voltage monitor. Set to 0, disable battery voltage monitor. If enable this bit, the monitor value is value after one monitor cycle. Note that the monitor cycle time is at least 300ms for W83697HF hardware monitor.

Fan divisor table :

Bit 2	Bit 1	Bit 0	Fan Divisor	Bit 2	Bit 1	Bit 0	Fan Divisor
0	0	0	1	1	0	0	16
0	0	1	2	1	0	1	32
0	1	0	4	1	1	0	64
0	1	1	8	1	1	1	128



9.7.27 Reserved Register -- 5Eh (Bank 0)

9.7.28 Reserved Register -- 5Fh (Bank 0)

9.7.29 Temperature Sensor 2 Temperature (High Byte) Register - Index 50h (Bank 1)

Register Location: 50h
 Attribute: Read Only
 Size: 8 bits

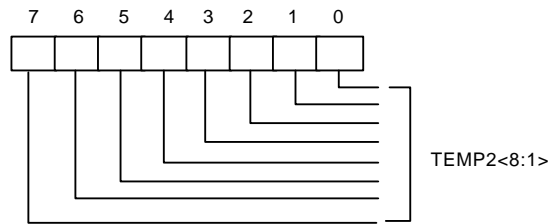

Bit 7: Temperature <8:1> of sensor 2, which is high byte, means 1°C.

9.7.30 Temperature Sensor 2 Temperature (Low Byte) Register - Index 51h (Bank 1)

Register Location: 51h
 Attribute: Read Only
 Size: 8 bits

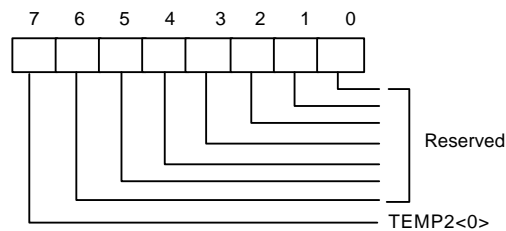

Bit 7: Temperature <0> of sensor2, which is low byte, means 0.5°C.

Bit 6-0: Reserved.

9.7.31 Temperature Sensor 2 Configuration Register - Index 52h (Bank 1)

Register Location: 52h
 Power on Default Value 00h
 Size: 8 bits

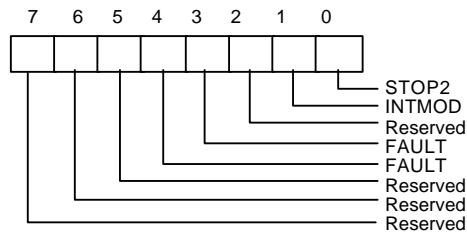

Bit 7-5: Read - Reserved. This bit should be set to 0.

Bit 4-3: Read/Write - Number of faults to detect before setting OVT# output to avoid false tripping due to noise.

Bit 2: Read - Reserved. This bit should be set to 0.

Bit 1: Read/Write - OVT# Interrupt mode select. This bit default is set to 0, which is compared mode. When set to 1, interrupt mode will be selected.

Bit 0: Read/Write - When set to 1 the sensor will stop monitor.

9.7.32 Temperature Sensor 2 Hysteresis (High Byte) Register - Index 53h (Bank 1)

Register Location: 53h
 Power on Default Value 4Bh
 Attribute: Read/Write
 Size: 8 bits

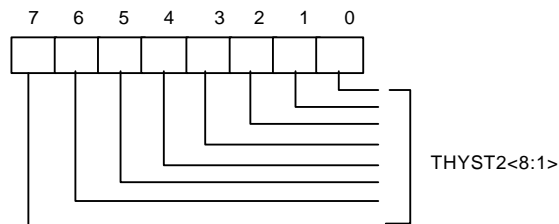

Bit 7-0: Temperature hysteresis bit 8-1, which is High Byte. The temperature default 75 degree C.



9.7.33 Temperature Sensor 2 Hysteresis (Low Byte) Register - Index 54h (Bank 1)

Register Location: 54h

Power on Default Value 00h

Attribute: Read/Write

Size: 8 bits

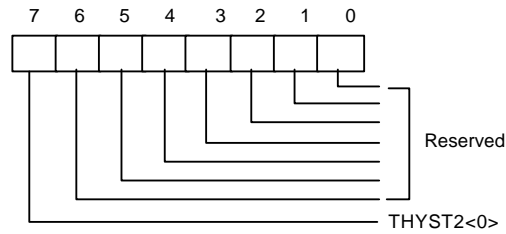

Bit 7: Hysteresis temperature bit 0, which is low Byte.

Bit 6-0: Reserved.

9.7.34 Temperature Sensor 2 Over-temperature (High Byte) Register - Index 55h (Bank 1)

Register Location: 55h

Power on Default Value 50h

Attribute: Read/Write

Size: 8 bits

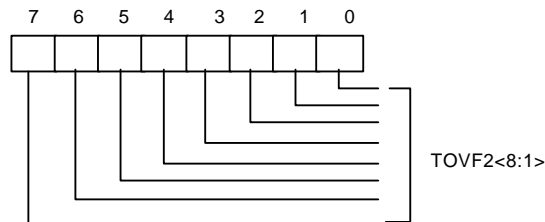

Bit 7-0: Over-temperature bit 8-1, which is High Byte. The temperature default 80 degree C.



9.7.35 Temperature Sensor 2 Over-temperature (Low Byte) Register - Index 56h (Bank 1)

Register Location: 56h

Power on Default Value 00h

Attribute: Read/Write

Size: 8 bits

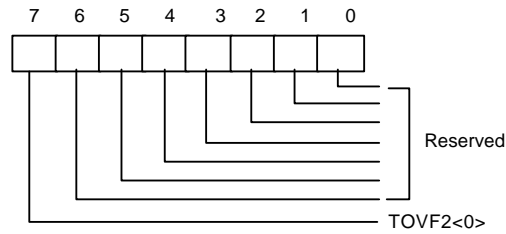

Bit 7: Over-temperature bit 0, which is low Byte.

Bit 6-0: Reserved.

9.7.36 Interrupt Status Register 3 – Index 50h (BANK4)

Register Location: 50h

Power on Default Value 00h

Attribute: Read Only

Size: 8 bits

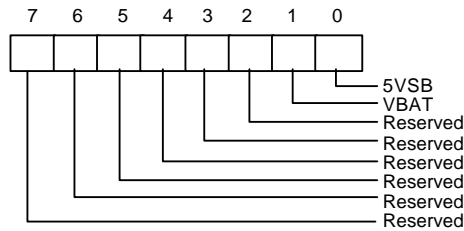

Bit 7-2: Reserved.

Bit 1: A one indicates a High or Low limit of VBAT has been exceeded.

Bit 0: A one indicates a High or Low limit of 5VSB has been exceeded.



9.7.37 SMI# Mask Register 3 -- Index 51h (BANK 4)

Register Location: 51h

Power on Default Value 00h

Attribute: Read/Write

Size: 8 bits

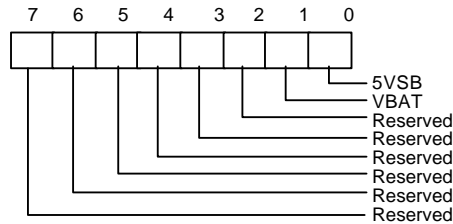

Bit 7-2: Reserved.

Bit 1: A one disables the corresponding interrupt status bit for $\overline{\text{SMI}}$ interrupt.

Bit 0: A one disables the corresponding interrupt status bit for $\overline{\text{SMI}}$ interrupt.

9.7.38 Reserved Register -- Index 52h (Bank 4)

9.7.39 BEEP Control Register 3-- Index 53h (Bank 4)

Register Location: 53h

Power on Default Value 00h

Attribute: Read/Write

Size: 8 bits

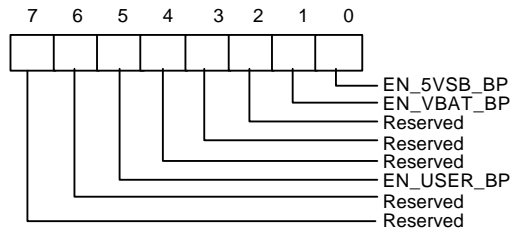

Bit 7-6: Reserved.

Bit 5: User define BEEP output function. Write 1, the BEEP is always active. Write 0, this function is inactive. (Default 0)

Bit 4-2: Reserved.

Bit 1: Enable BEEP output from VBAT. Write 1, enable BEEP output, which is default value.

Bit 0: Enable BEEP Output from 5VSB. Write 1, enable BEEP output, which is default value.



9.7.40 Temperature Sensor 1 Offset Register -- Index 54h (Bank 4)

Register Location: 54h
 Power on Default Value 00h
 Attribute: Read/Write
 Size: 8 bits

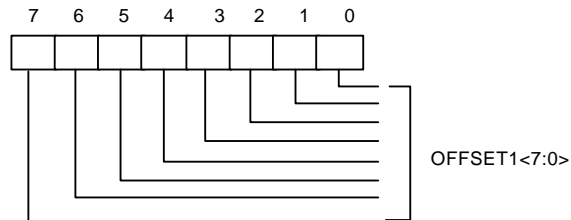

Bit 7-0: Temperature 1 base temperature. The temperature is added by both monitor value and offset value.

9.7.41 Temperature Sensor 2 Offset Register -- Index 55h (Bank 4)

Register Location: 55h
 Power on Default Value 00h
 Attribute: Read/Write
 Size: 8 bits

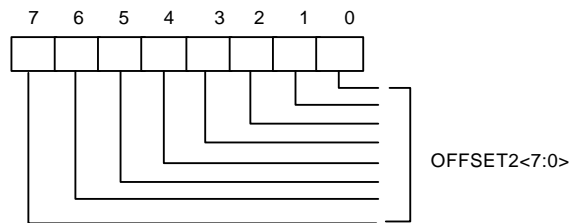

Bit 7-0: Temperature 2 base temperature. The temperature is added by both monitor value and offset value.

9.7.42 Reserved Register -- Index 57h--58h



9.7.43 Real Time Hardware Status Register I -- Index 59h (Bank 4)

Register Location: 59h
 Power on Default Value 00h
 Attribute: Read Only
 Size: 8 bits

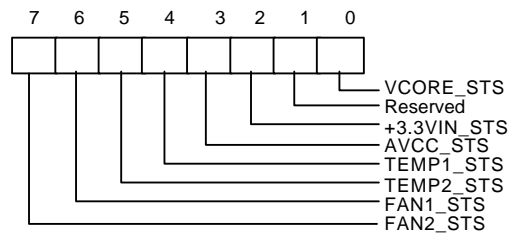

- Bit 7: FAN 2 Status. Set 1, the fan speed counter is over the limit value. Set 0, the fan speed counter is in the limit range.
- Bit 6: FAN 1 Status. Set 1, the fan speed counter is over the limit value. Set 0, the fan speed counter is in the limit range.
- Bit 5: Temperature sensor 2 Status. Set 1, the voltage of temperature sensor is over the limit value. Set 0, the voltage of temperature sensor is in the limit range.
- Bit 4: Temperature sensor 1 Status. Set 1, the voltage of temperature sensor is over the limit value. Set 0, the voltage of temperature sensor is in the limit range.
- Bit 3: AVCC Voltage Status. Set 1, the voltage of +5V is over the limit value. Set 0, the voltage of +5V is in the limit range.
- Bit 2: +3.3V Voltage Status. Set 1, the voltage of +3.3V is over the limit value. Set 0, the voltage of +3.3V is in the limit range.
- Bit 1: Reserved
- Bit 0: VCORE Voltage Status. Set 1, the voltage of VCORE A is over the limit value. Set 0, the voltage of VCORE A is in the limit range.

9.7.44 Real Time Hardware Status Register II -- Index 5Ah (Bank 4)

Register Location: 5Ah
 Power on Default Value 00h
 Attribute: Read Only
 Size: 8 bits

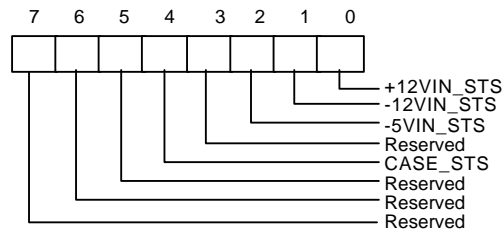

Bit 7-6: Reserved

Bit 5: Reserved

Bit 4: Case Open Status. Set 1, the case open sensor is sensed the high value. Set 0

Bit 3: Reserved

Bit 2: -5V Voltage Status. Set 1, the voltage of -5V is over the limit value. Set 0, the voltage of -5V is during the limit range.

Bit 1: -12V Voltage Status. Set 1, the voltage of -12V is over the limit value. Set 0, the voltage of -12V is during the limit range.

Bit 0: +12V Voltage Status. Set 1, the voltage of +12V is over the limit value. Set 0, the voltage of +12V is in the limit range.

9.7.45 Real Time Hardware Status Register III -- Index 5Bh (*Bank 4*)

Register Location: 5Bh

Power on Default Value 00h

Attribute: Read Only

Size: 8 bits

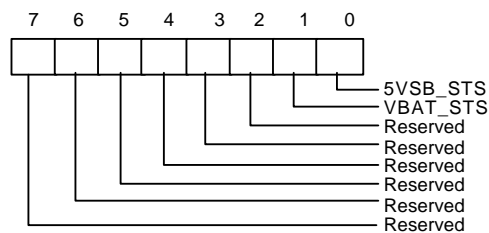

Bit 7-2: Reserved.

Bit 1: VBAT Voltage Status. Set 1, the voltage of VBAT is over the limit value. Set 0, the voltage of VBAT is during the limit range.

Bit 0: 5VSB Voltage Status. Set 1, the voltage of 5VSB is over the limit value. Set 0, the voltage of 5VSB is in the limit range.



9.7.46 Reserved Register -- Index 5Ch (Bank 4)

9.7.47 Reserved Register -- Index 5Dh (Bank 4)

9.7.48 Value RAM $2^{3/4}$ Index 50h - 5Ah (auto-increment) (BANK 5)

Address A6-A0 Auto-Increment	Description
50h	5VSB reading
51h	VBAT reading
52h	Reserved
53h	Reserved
54h	5VSB High Limit
55h	5VSB Low Limit.
56h	VBAT High Limit
57h	VBAT Low Limit

9.7.49 Winbond Test Register -- Index 50h (Bank 6)

9.7.50 FAN 1 Pre-Scale Register--Index00h

Power on default [7:0] = 0000-0001 b

Bit	Name	Read/Write	Description
7	PWM_CLK_SEL1	Read/Write	PWM Input Clock Select. This bit select Fan 1 input clock to pre-scale divider. 0: 24 MHz 1: 180 KHz
6-0	PRE_SCALE1[6:0]	Read/Write	Fan 1 Input Clock Pre-Scale. The divider of input clock is the number defined by pre-scale. Thus, writing 1 transfers the input clock directly to counter. The maximum divider is 128 (7Fh). 01h : divider is 1 02h : divider is 2 03h : divider is 3

$$\text{PWM frequency} = (\text{Input Clock} / \text{Pre-scale}) / 256$$



9.7.51 FAN 1 Duty Cycle Select Register-- 01h (Bank 0)

Power on default [7:0] 1111,1111 b

Bit	Name	Read/Write	Description
7-0	F1_DC[7:0]	Read/Write	<p>FanPWM1 Duty Cycle. This 8-bit register determines the number of input clock cycles, out of 256-cycle period, during which the PWM output is high. During smart fan 1 control mode, read this register will return smart fan duty cycle.</p> <p>00h: PWM output is always logical Low.</p> <p>FFh: PWM output is always logical High.</p> <p>XXh: PWM output logical High percentage is $(XX/256*100\%)$ during one cycle.</p>

9.7.52 FAN 2 Pre-Scale Register-- Index 02h

Power on default [7:0] = 0000,0001 b

Bit	Name	Read/Write	Description
7	PWM_CLK_SEL2	Read/Write	<p>PWM 2 Input Clock Select. This bit select Fan 2 input clock to pre-scale divider.</p> <p>0: 1 MHz</p> <p>1: 125 KHz</p>
6-0	PRE_SCALE2[6:0]	Read/Write	<p>Fan 2 Input Clock Pre-Scale. The divider of input clock is the number defined by pre-scale. Thus, writing 0 transfers the input clock directly to counter. The maximum divider is 128 (7Fh).</p> <p>01h : divider is 1</p> <p>02h : divider is 2</p> <p>03h : divider is 3</p> <p style="text-align: center;">:</p> <p style="text-align: center;">:</p>

PWM frequency = (Input Clock / Pre-scale) / 256



9.7.53 FAN2 Duty Cycle Select Register-- Index 03h

Power on default [7:0] = 1111,1111 b

Bit	Name	Read/Write	Description
7-0	F2_DC[7:0]	Read/Write	<p>FanPWM2 Duty Cycle. This 8-bit register determines the number of input clock cycles, out of 256-cycle period, during which the PWM output is high. During smart fan 2 control mode, read this register will return smart fan duty cycle.</p> <p>00h: PWM output is always logical Low.</p> <p>FFh: PWM output is always logical High.</p> <p>XXh: PWM output logical High percentage is $XX/256*100\%$ during one cycle.</p>

9.7.54 FAN Configuration Register-- Index 04h

Power on default [7:0] = 0000,0000 b

Bit	Name	Read/Write	Description
7-2	Reserved	Read/Write	Reserved
5-4	FAN2_MODE	Read/Write	<p>FAN 2 PWM Control Mode.</p> <p>00 - Manual PWM Control Mode. (Default)</p> <p>01 - Thermal Cruise mode.</p> <p>10 - Fan Speed Cruise Mode.</p> <p>11 - Reserved.</p>
3-2	FAN1_MODE	Read/Write	<p>FAN 1 PWM Control Mode.</p> <p>00 - Manual PWM Control Mode. (Default)</p> <p>01 - Thermal Cruise mode.</p> <p>10 - Fan Speed Cruise Mode.</p> <p>11 - Reserved.</p>
1	FAN2_OB	Read/Write	<p>Enable Fan 2 as Output Buffer. Set to 0, FANPWM2 can drive logical high or logical low. Set to 1, FANPWM2 is open-drain</p>
0	FAN1_OB	Read/Write	<p>Enable Fan 1 as Output Buffer. Set to 0, FANPWM1 can drive logical high or logical low. Set to 1, FANPWM1 is open-drain</p>



9.7.55 VTIN1 Target Temperature Register/ Fan 1 Target Speed Register – Index 05h

Power on default [7:0] = 0000,0000 b

CPUT1 target temperature register for Thermal Cruise mode.

Bit	Name	Read/Write	Description
7	Reserved	Read/Write	Reserved.
6-0	TEMP_TAR_T1[6:0]	Read/Write	VTIN1 Target Temperature. Only for Thermal Cruise Mode while CR84h bit3-2 is 01.

Fan 1 target speed register for Fan Speed Cruise mode.

Bit	Name	Read/Write	Description
7-0	SPD_TAR_FAN1[7:0]	Read/Write	Fan 1 Target Speed Control. Only for Fan Speed Cruise Mode while CR84h bit3-2 is 10.

9.7.56 VTIN2 Target Temperature Register/ Fan 2 Target Speed Register – Index 06h

Power on - [7:0] = 0000,0000 b

CPUT2 target temperature register for Thermal Cruise mode.

Bit	Name	Read/Write	Description
7	Reserved	Read/Write	Reserved.
6-0	TEMP_TAR_T2[6:0]	Read/Write	VTIN2 Target Temperature. Only for Thermal Cruise Mode while CR84h bit5-4 is 01.

Fan 2 target speed register for Fan Speed Cruise mode.

Bit	Name	Read/Write	Description
7-0	SPD_TAR_FAN2[7:0]	Read/Write	Fan 2 Target Speed Control. Only for Fan Speed Cruise Mode while CR84h bit5-4 is 10.



9.7.57 Tolerance of Target Temperature or Target Speed Register -- Index 07h

Power on default [7:0] = 0001,0001 b

Tolerance of CPUT1/CPUT2 target temperature register.

Bit	Name	Read/Write	Description
7-4	TOL_T2[3:0]	Read/Write	Tolerance of VTIN2 Target Temperature. Only for Thermal Cruise mode.
3-0	TOL_T1[3:0]	Read/Write	Tolerance of VTIN1 Target Temperature. Only for Thermal Cruise mode.

Tolerance of Fan 1/2 target speed register.

Bit	Name	Read/Write	Description
7-4	TOL_FS2[3:0]	Read/Write	Tolerance of Fan 2 Target Speed Count. Only for Fan Speed Cruise mode.
3-0	TOL_FS1[3:0]	Read/Write	Tolerance of Fan 1 Target Speed Count. Only for Fan Speed Cruise mode.

9.7.58 Fan 1 PWM Stop Duty Cycle Register -- Index 08h

Power on default [7:0] = 0000,0001 b

Bit	Name	Read/Write	Description
7-0	STOP_DC1[7:0]	Read/Write	In Thermal Cruise mode, PWM duty will be 0 if it decreases to under this value. This register should be written a non-zero minimum PWM stop duty cycle.

9.7.59 Fan 2 PWM Stop Duty Cycle Register -- 09h (Bank 0)

Power on default [7:0] = 0000,0001 b

Bit	Name	Read/Write	Description
7-0	STOP_DC2[7:0]	Read/Write	In Thermal Cruise mode, PWM duty will be 0 if it decreases to under this register value. This register should be written a non-zero minimum PWM stop duty cycle.



9.7.60 Fan 1 Start-up Duty Cycle Register – Index 0Ah

Power on default [7:0] = 0000,0001 b

Bit	Name	Read/Write	Description
7-0	START_DC1[7:0]	Read/Write	In Thermal Cruise mode, PWM duty will increase from 0 to this register value to provide a minimum duty cycle to turn on the fan. This register should be written a fan start-up duty cycle.

9.7.61 Fan 2 Start-up Duty Cycle Register – Index 0Bh

Power on default [7:0] = 0000,0001 b

Bit	Name	Read/Write	Description
7-0	START_DC2[7:0]	Read/Write	In Thermal Cruise mode, PWM duty will increase from 0 to this register value to provide a minimum duty cycle to turn on the fan. This register should be written a fan start-up duty cycle.

9.7.62 Fan 1 Stop Time Register – Index 0Ch

Power on default [7:0] = 0011,1100 b

Bit	Name	Read/Write	Description
7-0	STOP_TIME1[7:0]	Read/Write	In Thermal Cruise mode, this register determines the time of which PWM duty is from stop duty cycle to 0 duty cycle. The unit of this register is 0.1 second. The default value is 6 seconds.

9.7.63 Fan 2 Stop Time Register – Index 0Dh

Power on default [7:0] = 0011,1100 b

Bit	Name	Read/Write	Description
7-0	STOP_TIME2[7:0]	Read/Write	In Thermal Cruise mode, this register determines the time of which PWM duty is from stop duty cycle to 0 duty cycle. The unit of this register is 0.1 second. The default value is 6 seconds.

**9.7.64 Fan Step Down Time Register -- Index 0Eh**

Power on default [7:0] = 0000,1010 b

Bit	Name	Read/Write	Description
7-0	STEP_UP_T[7:0]	Read/Write	The time interval, which is 0.1 second unit, to decrease PWM duty in Smart Fan Control mode.

9.7.65 Fan Step Up Time Register -- Index 0Fh

Power on default [7:0] = 0000,1010 b

Bit	Name	Read/Write	Description
7-0	STEP_DOWN_T[7:0]	Read/Write	The time interval, which is 0.1 second unit, to increase PWM duty in Smart Fan Control mode.

10 CONFIGURATION REGISTER

10.1 Plug and Play Configuration

The W83697HF uses Compatible PNP protocol to access configuration registers for setting up different types of configurations. In W83697HF, there are eleven Logical Devices (from Logical Device 0 to Logical Device B with the exception of logical device 4 for backward compatibility) which correspond to eleven individual functions: FDC (logical device 0), PRT (logical device 1), UART1 (logical device 2), UART2 (logical device 3), CIR (Consumer IR, logical device 6), GPIO1 (logical device 7), GPIO5 (logical device 8), GPIO2 ~GPIO4 (logical device 9), ACPI ((logical device A), and Hardware monitor (logical device B). Each Logical Device has its own configuration registers (above CR30). Host can access those registers by writing an appropriate logical device number into logical device select register at CR7.

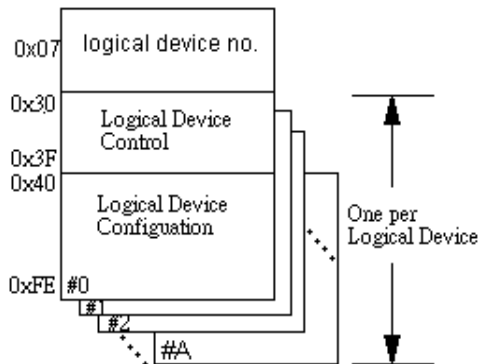

10.2 Compatible PnP

10.2.1 Extended Function Registers

In Compatible PnP, there are two ways to enter Extended Function and read or write the configuration registers. HEFRAS (CR26 bit 6) can be used to select one out of these two methods of entering the Extended Function mode as follows:

HEFRAS	address and value
0	write 87h to the location 2Eh twice
1	write 87h to the location 4Eh twice

After Power-on reset, the value on RTSA# (pin 49) is latched by HEFRAS of CR26. In Compatible PnP, a specific value (87h) must be written twice to the Extended Functions Enable Register (I/O port address 2Eh or 4Eh). Secondly, an index value (02h, 07h-FFh) must be written to the Extended Functions Index Register (I/O port address 2Eh or 4Eh same as Extended Functions Enable Register) to identify which configuration register is to be accessed. The designer can then access the desired configuration register through the Extended Functions Data Register (I/O port address 2Fh or 4Fh).

After programming of the configuration register is finished, an additional value (AAh) should be written to EFERs to exit the Extended Function mode to prevent unintentional access to those configuration registers. The designer can also set bit 5 of CR26 (LOCKREG) to high to protect the configuration registers against accidental accesses.

The configuration registers can be reset to their default or hardware settings only by a cold reset (pin MR = 1). A warm reset will not affect the configuration registers.

10.2.2 Extended Functions Enable Registers (EFERs)

After a power-on reset, the W83697HF enters the default operating mode. Before the W83697HF enters the extended function mode, a specific value must be programmed into the Extended Function Enable Register (EFER) so that the extended function register can be accessed. The Extended Function Enable Registers are write-only registers. On a PC/AT system, their port addresses are 2Eh or 4Eh (as described in previous section).

10.2.3 Extended Function Index Registers (EFIRs), Extended Function Data Registers(EFDRs)

After the extended function mode is entered, the Extended Function Index Register (EFIR) must be loaded with an index value (02h, 07h-FEh) to access Configuration Register 0 (CR0), Configuration Register 7 (CR07) to Configuration Register FE (CRFE), and so forth through the Extended Function Data Register (EFDR). The EFIRs are write-only registers with port address 2Eh or 4Eh (as described in section 12.2.1) on PC/AT systems; the EFDRs are read/write registers with port address 2Fh or 4Fh (as described in section 9.2.1) on PC/AT systems.



10.3 Configuration Sequence

To program W83697HF configuration registers, the following configuration sequence must be followed:

- (1). Enter the extended function mode
- (2). Configure the configuration registers
- (3). Exit the extended function mode

10.3.1 Enter the extended function mode

To place the chip into the extended function mode, two successive writes of 0x87 must be applied to Extended Function Enable Registers(EFERs, i.e. 2Eh or 4Eh).

10.3.2 Configure the configuration registers

The chip selects the logical device and activates the desired logical devices through Extended Function Index Register(EFIR) and Extended Function Data Register(EFDR). EFIR is located at the same address as EFER, and EFDR is located at address (EFIR+1).

First, write the Logical Device Number (i.e.,0x07) to the EFIR and then write the number of the desired logical device to the EFDR. If accessing the Chip(Global) Control Registers, this step is not required.

Secondly, write the address of the desired configuration register within the logical device to the EFIR and then write (or read) the desired configuration register through EFDR.

10.3.3 Exit the extended function mode

To exit the extended function mode, one write of 0xAA to EFER is required. Once the chip exits the extended function mode, it is in the normal running mode and is ready to enter the configuration mode.

10.3.4 Software programming example

The following example is written in Intel 8086 assembly language. It assumes that the EFER is located at 2Eh, so EFIR is located at 2Eh and EFDR is located at 2Fh. If HEFRAS (CR26 bit 6) is set, 4Eh can be directly replaced by 4Eh and 2Fh replaced by 4Fh.



```
-----  
; Enter the extended function mode ,interruptible double-write |  
-----  
MOV DX,2EH  
MOV AL,87H  
OUT DX,AL  
OUT DX,AL  
-----  
; Configurate logical device 1, configuration register CRF0 |  
-----  
MOV DX,2EH  
MOV AL,07H  
OUT DX,AL ; point to Logical Device Number Reg.  
MOV DX,2FH  
MOV AL,01H  
OUT DX,AL ; select logical device 1  
;  
MOV DX,2EH  
MOV AL,F0H  
OUT DX,AL ; select CRF0  
MOV DX,2FH  
MOV AL,3CH  
OUT DX,AL ; update CRF0 with value 3CH  
-----  
; Exit extended function mode |  
-----  
MOV DX,2EH  
MOV AL,AAH  
OUT DX,AL
```



10.4 Chip (Global) Control Register

CR02 (Default 0x00)

- Bit 7 - 1 : Reserved.
- Bit 0 : SWRST --> Soft Reset.

CR07

- Bit 7 - 0 : LDNB7 - LDNB0 --> Logical Device Number Bit 7 - 0

CR20

- Bit 7 - 0 : DEVIDB7 - DEBIDB0 --> Device ID Bit 7 - Bit 0 = 0x 60 (read only).

CR21

- Bit 7 - 0 : DEVREVB7 - DEBREVB0 --> Device Rev = 0x1X (read only).
- X : Version change number .(Bit 3~0).

CR22 (Default 0xff)

- Bit 7~ 5 : Reserved.
- Bit 4 : HMPWD
 - = 0 Power down
 - = 1 No Power down
- Bit 3 : URBPWD
 - = 0 Power down
 - = 1 No Power down
- Bit 2 : URAPWD
 - = 0 Power down
 - = 1 No Power down
- Bit 1 : PRTPWD
 - = 0 Power down
 - = 1 No Power down
- Bit 0 : FDCPWD
 - = 0 Power down
 - = 1 No Power down



CR23 (Default 0x00)

Bit 7 ~ 1 : Reserved.

Bit 0 : IPD (Immediate Power Down). When set to 1, it will put the whole chip into power down mode immediately.

CR24 (Default 0x00)

Bit 7 : Reserved.

Bit 6 : CLKSEL(Enable 48Mhz)
= 0 The clock input on Pin 1 should be 24 Mhz.
= 1 The clock input on Pin 1 should be 48 Mhz.
The corresponding power-on setting pin is SOUTB (pin 61).

Bit[5:4] : ROM size select

=00 1M
=01 2M
=10 4M
=11 Reserved

Bit 3 :MEMW# Select (PIN97)

= 0 MEMW# Disable
= 1 MEMW# Enable

Bit 2 :Reserved

Bit 1 : Enable Flash ROM Interface

= 0 Flash ROM Interface is enabled after hardware reset
= 1 Flash ROM Interface is disabled after hardware reset

This bit is read only, and set/reset by power-on setting pin. The corresponding power-on setting pin is PENROM#(pin 52)

Bit 0 : PNPCSV

= 0 The Compatible PnP address select registers have default values.
= 1 The Compatible PnP address select registers have no default value.

The corresponding power-on setting pin is DTRA# (pin 50).

CR25 (Default 0x00)

Bit 7 ~ 4 : Reserved

Bit 3 : URBTRI

Bit 2 : URATRI

Bit 1 : PRITRI

Bit 0 : FDCTRI.

CR26 (Default 0x00)

- Bit 7 : SEL4FDD
= 0 Select two FDD mode.
= 1 Select four FDD mode
- Bit 6 : HEFRAS
These two bits define how to enable Configuration mode. The corresponding power-on setting pin is RTSA #(pin 49).
HEFRAS Address and Value
= 0 Write 87h to the location 2E twice.
= 1 Write 87h to the location 4E twice.
- Bit 5 : LOCKREG
= 0 Enable R/W Configuration Registers.
= 1 Disable R/W Configuration Registers.
- Bit 4 : Reserved
- Bit 3 : DSFDLGRQ
= 0 Enable FDC legacy mode on IRQ and DRQ selection, then DO register bit 3 is effective on selecting IRQ
= 1 Disable FDC legacy mode on IRQ and DRQ selection, then DO register bit 3 is not effective on selecting IRQ
- Bit 2 : DSPRLGRQ
= 0 Enable PRT legacy mode on IRQ and DRQ selection, then DCR bit 4 is effective on selecting IRQ
= 1 Disable PRT legacy mode on IRQ and DRQ selection, then DCR bit 4 is not effective on selecting IRQ
- Bit 1 : DSUALGRQ
= 0 Enable UART A legacy mode IRQ selecting, then MCR bit 3 is effective on selecting IRQ
= 1 Disable UART A legacy mode IRQ selecting, then MCR bit 3 is not effective on selecting IRQ
- Bit 0 : DSUBLGRQ
= 0 Enable UART B legacy mode IRQ selecting, then MCR bit 3 is effective on selecting IRQ
= 1 Disable UART B legacy mode IRQ selecting, then MCR bit 3 is not effective on selecting IRQ



CR28 (Default 0x00)

- Bit 7 - 3 : Reserved.
- Bit 2 - 0 : PRTMODS2 - PRTMODS0
 - = 0xx Parallel Port Mode
 - = 100 Reserved
 - = 101 External FDC Mode
 - = 110 Reserved
 - = 111 External two FDC Mode

CR29 (GPIO1,5(50~51) & Game port & MIDI port Select default 0x00)

- Bit 7 : Port Select (select Game Port or General Purpose I/O Port 1)
 - = 0 Game Port
 - = 1 General Purpose I/O Port 1 (pin121~128 select function GP10~GP17)
- Bit [6:5] : (Pin119)
 - =00 MSI
 - =01 WDTO
 - =10 Reserved
 - =11 GP51
- Bit[4:3] : (Pin 120)
 - =00 MSO
 - =01 PLED
 - =10 Reserved
 - =11 GP50
- Bit 2 : (Pin117)
 - OVT# & SMI Select(Pin117)
 - = 0 OVT#
 - = 1 SMI#
- Bit 1~0 : Reserved

CR2A(GPIO2 ~ 5& Fresh ROM Interface Select

Default 0xFF if PENROM# = 0 during POR, default 0x00 otherwise)

- Bit 7 : (PIN 86 ~89 & 91 ~94)
 - = 0 GPIO 2
 - = 1 Fresh IF (xD7 ~ XD0)
- Bit 6 : (PIN 78 ~ 85)
 - = 0 GPIO 3
 - = 1 Fresh IF (XA7 ~ XA0)



- Bit 5 : (PIN 69 ~ 74 & 76 ~ 77)
 - = 0 GPIO 4
 - = 1 Fresh IF (XA15 ~ XA10 & XA7 ~ A0)
- Bit 4 : (PIN 66 ~ 68 & 95 ~ 97)
 - = 0 GPIO 5(GP52 ~ 57)
 - = 1 Fresh IF(XA18 ~ XA16 , ROMCS#, MEMR #, MEMW#)
- Bit 0~3 : Reserved

10.5 Logical Device 0 (FDC)

CR30 (Default 0x01 if PNPCSV = 0 during POR, default 0x00 otherwise)

- Bit 7 - 1 : Reserved.
- Bit 0 = 1 Activates the logical device.
- = 0 Logical device is inactive.

CR60, CR 61 (Default 0x03, 0xf0 if PNPCSV = 0 during POR, default 0x00, 0x00 otherwise)

These two registers select FDC I/O base address [0x100:0xFF8] on 8 byte boundary.

CR70 (Default 0x06 if PNPCSV = 0 during POR, default 0x00 otherwise)

- Bit 7 - 4 : Reserved.
- Bit 3 - 0 : These bits select IRQ resource for FDC.

CR74 (Default 0x02 if PNPCSV = 0 during POR, default 0x04 otherwise)

- Bit 7 - 3 : Reserved.
- Bit 2 - 0 : These bits select DRQ resource for FDC.
 - = 000 DMA0
 - = 001 DMA1
 - = 010 DMA2
 - = 011 DMA3
 - = 100 - No DMA active
 - 111



CRF0 (Default 0x0E)

FDD Mode Register

- Bit 7 : FIPURDWN
This bit controls the internal pull-up resistors of the FDC input pins RDATA, INDEX, TRAK0, DSKCHG, and WP.
= 0 The internal pull-up resistors of FDC are turned on.(Default)
= 1 The internal pull-up resistors of FDC are turned off.
- Bit 6 : INVERTZ
This bit determines the polarity of all FDD interface signals.
= 0 FDD interface signals are active low.
= 1 FDD interface signals are active high.
- Bit 5 : DRV2EN (PS2 mode only)
When this bit is a logic 0, indicates a second drive is installed and is reflected in status register A.
- Bit 4 : Swap Drive 0, 1 Mode
= 0 No Swap (Default)
= 1 Drive and Motor select 0 and 1 are swapped.
- Bit 3 - 2 Interface Mode
= 11 AT Mode (Default)
= 10 (Reserved)
= 01 PS/2
= 00 Model 30
- Bit 1 : FDC DMA Mode
= 11 Burst Mode is enabled
= 10 Non-Burst Mode (Default)
- Bit 0 : Floppy Mode
= 11 Normal Floppy Mode (Default)
= 10 Enhanced 3-mode FDD

CRF1 (Default 0x00)

- Bit 7 - 6 : Boot Floppy
= 00 FDD A
= 01 FDD B
= 10 FDD C
= 11 FDD D
- Bit 5, 4 : Media ID1, Media ID0. These bits will be reflected on FDC's Tape Drive Register bit 7, 6.



Bit 3 - 2 : Density Select

- = 00 Normal (Default)
- = 01 Normal
- = 10 1 (Forced to logic 1)
- = 11 0 (Forced to logic 0)

Bit 1 : DISFDDWR

- = 0 Enable FDD write.
- = 1 Disable FDD write(forces pins WE, WD stay high).

Bit 0: SWWP

- = 0 Normal, use WP to determine whether the FDD is write protected or not.
- = 1 FDD is always write-protected.

CRF2 (Default 0xFF)

Bit 7 - 6 : FDD D Drive Type

Bit 5 - 4 : FDD C Drive Type

Bit 3 - 2 : FDD B Drive Type

Bit 1 - 0 : FDD A Drive Type

CRF4 (Default 0x00)

FDD0 Selection:

Bit 7: Reserved.

Bit 6 : Pre-comp Disable.

- = 1 Disable FDC Pre-compensation.
- = 0 Enable FDC Pre-compensation.

Bit 5 : Reserved.

Bit 4 - 3 : DRTS1, DRTS0: Data Rate Table select (Refer to TABLE A).

- = 00 Select Regular drives and 2.88 format
- = 01 3-mode drive
- = 10 2 Meg Tape
- = 11 Reserved

Bit 2 : Reserved.

Bit 1:0 : DTYPE0, DTYPE1: Drive Type select (Refer to TABLE B).

CRF5 (Default 0x00)

FDD1 Selection: Same as FDD0 of CRF4.



TABLE A

Drive Rate Table Select		Data Rate		Selected Data Rate		SELDEN
DRTS1	DRTS0	DRATE1	DRATE0	MFM	FM	
0	0	1	1	1Meg	---	1
		0	0	500K	250K	1
		0	1	300K	150K	0
		1	0	250K	125K	0
0	1	1	1	1Meg	---	1
		0	0	500K	250K	1
		0	1	500K	250K	0
		1	0	250K	125K	0
1	0	1	1	1Meg	---	1
		0	0	500K	250K	1
		0	1	2Meg	---	0
		1	0	250K	125K	0

TABLE B

DTYPE0	DTYPE1	DRV DEN0(pin 2)	DRV DEN1(pin 3)	DRIVE TYPE
0	0	SELDEN	DRATE0	4/2/1 MB 3.5" " 2/1 MB 5.25" " 2/1.6/1 MB 3.5" (3-MODE)
0	1	DRATE1	DRATE0	
1	0	$\overline{\text{SELDEN}}$	DRATE0	
1	1	DRATE0	DRATE1	

10.6 Logical Device 1 (Parallel Port)

CR30 (Default 0x01 if PNPCSV = 0 during POR, default 0x00 otherwise)

- Bit 7 - 1 : Reserved.
- Bit 0 = 1 Activates the logical device.
- = 0 Logical device is inactive.

CR60, CR 61 (Default 0x03, 0x78 if PNPCSV = 0 during POR, default 0x00, 0x00 otherwise)

These two registers select Parallel Port I/O base address.
[0x100:0xFFC] on 4 byte boundary (EPP not supported) or
[0x100:0xFF8] on 8 byte boundary (all modes supported, EPP is only available when the base address is on 8 byte boundary).

CR70 (Default 0x07 if PNPCSV = 0 during POR, default 0x00 otherwise)

- Bit 7 - 4 : Reserved.
- Bit [3:0] : These bits select IRQ resource for Parallel Port.

CR74 (Default 0x04)

- Bit 7 - 3 : Reserved.
- Bit 2 - 0 : These bits select DRQ resource for Parallel Port.
 - 000=DMA0
 - 001=DMA1
 - 010=DMA2
 - 011=DMA3
 - 100 – 111= No DMA active

CRF0 (Default 0x3F)

- Bit 7 : Reserved.
- Bit 6 - 3 : ECP FIFO Threshold.
- Bit 2 - 0 : Parallel Port Mode (CR28 PRTMODS2 = 0)
 - = 100 Printer Mode (Default)
 - = 000 Standard and Bi-direction (SPP) mode
 - = 001 EPP - 1.9 and SPP mode
 - = 101 EPP - 1.7 and SPP mode
 - = 010 ECP mode
 - = 011 ECP and EPP - 1.9 mode
 - = 111 ECP and EPP - 1.7 mode.

10.7 Logical Device 2 (UART A)

CR30 (Default 0x01 if PNPCSV = 0 during POR, default 0x00 otherwise)

Bit 7 - 1 : Reserved.

Bit 0 = 1 Activates the logical device.

= 0 Logical device is inactive.

CR60, CR 61 (Default 0x03, 0xF8 if PNPCSV = 0 during POR, default 0x00, 0x00 otherwise)

These two registers select Serial Port 1 I/O base address [0x100:0xFF8] on 8 byte boundary.

CR70 (Default 0x04 if PNPCSV = 0 during POR, default 0x00 otherwise)

Bit 7 - 4 : Reserved.

Bit 3 - 0 : These bits select IRQ resource for Serial Port 1.

CRF0 (Default 0x00)

Bit 7 - 2 : Reserved.

Bit 1 - 0 : SUACLKB1, SUACLKB0

= 00 UART A clock source is 1.8462 Mhz (24MHz/13)

= 01 UART A clock source is 2 Mhz (24MHz/12)

= 10 UART A clock source is 24 Mhz (24MHz/1)

= 11 UART A clock source is 14.769 Mhz (24mhz/1.625)

10.8 Logical Device 3 (UART B)

CR30 (Default 0x01 if PNPCSV = 0 during POR, default 0x00 otherwise)

Bit 7 - 1 : Reserved.

Bit 0 = 1 Activates the logical device.

= 0 Logical device is inactive.

CR60, CR 61 (Default 0x02, 0xF8 if PNPCSV = 0 during POR, default 0x00, 0x00 otherwise)

These two registers select Serial Port 2 I/O base address [0x100:0xFF8] on 8 byte boundary.

CR70 (Default 0x03 if PNPCSV = 0 during POR, default 0x00 otherwise)

Bit 7 - 4 : Reserved.

Bit [3:0] : These bits select IRQ resource for Serial Port 2.



CRF0 (Default 0x00)

- Bit 7 - 4 : Reserved.
- Bit 3 : RXW4C
 - = 0 No reception delay when SIR is changed from TX mode to RX mode.
 - = 1 Reception delays 4 characters-time (40 bit-time) when SIR is changed from TX mode to RX mode.
- Bit 2 : TXW4C
 - = 0 No transmission delay when SIR is changed from RX mode to TX mode.
 - = 1 Transmission delays 4 characters-time (40 bit-time) when SIR is changed from RX mode to TX mode.
- Bit 1 - 0 : SUBCLKB1, SUBCLKB0
 - = 00 UART B clock source is 1.8462 Mhz (24MHz/13)
 - = 01 UART B clock source is 2 Mhz (24MHz/12)
 - = 10 UART B clock source is 24 Mhz (24MHz/1)
 - = 11 UART B clock source is 14.769 Mhz (24mhz/1.625)

CRF1 (Default 0x00)

- Bit 7 : Reserved.
- Bit 6 : IRLOCSEL. IR I/O pins' location select.
 - = 0 Through SINB/SOUTB.
 - = 1 Through IRRX/IRTX.
- Bit 5 : IRMODE2. IR function mode selection bit 2.
- Bit 4 : IRMODE1. IR function mode selection bit 1
- Bit 3 : IRMODE0. IR function mode selection bit 0.

IR MODE	IR FUNCTION	IRTX	IRRX
00X	Disable	tri-state	high
010*	IrDA	Active pulse 1.6 μ S	Demodulation into SINB/IRRX
011*	IrDA	Active pulse 3/16 bit time	Demodulation into SINB/IRRX
100	ASK-IR	Inverting IRTX/SOUTB pin	routed to SINB/IRRX
101	ASK-IR	Inverting IRTX/SOUTB & 500 KHZ clock	routed to SINB/IRRX
110	ASK-IR	Inverting IRTX/SOUTB	Demodulation into SINB/IRRX
111*	ASK-IR	Inverting IRTX/SOUTB & 500 KHZ clock	Demodulation into SINB/IRRX

Note: The notation is normal mode in the IR function.

- Bit 2 : HDUPLX. IR half/full duplex function select.
= 0 The IR function is Full Duplex.
= 1 The IR function is Half Duplex.
- Bit 1 : TX2INV.
= 0 the SOUTB pin of UART B function or IRTX pin of IR function in normal condition.
= 1 inverse the SOUTB pin of UART B function or IRTX pin of IR function.
- Bit 0 : RX2INV.
= 0 the SINB pin of UART B function or IRRX pin of IR function in normal condition.
= 1 inverse the SINB pin of UART B function or IRRX pin of IR function

10.9 Logical Device 6 (CIR)

CR30 (Default 0x00)

- Bit 7 - 1 : Reserved.
- Bit 0 = 1 Activates the logical device.
= 0 Logical device is inactive.

CR60, CR 61 (Default 0x00, 0x00)

These two registers select CIR I/O base address [0x100:0xFF8] on 8 byte boundary.

CR70 (Default 0x00)

- Bit 7 - 4 : Reserved.
- Bit [3:0] : These bits select IRQ resource for CIR.

10.10 Logical Device 7 (Game Port GPIO Port 1)

CR30 (Default 0x00)

- Bit 7 - 1 : Reserved.
- Bit 0 = 1 Activate Game Port./GP1
= 0 Game Port/GP1 is inactive.

CR60, CR 61 (Default 0x02, 0x01 if PNPCSV = 0 during POR, default 0x00 otherwise)

These two registers select the Game Port base address [0x100:0xFFFF] on 8 byte boundary.



CR62, CR 63 (Default 0x00, 0x00)

These two registers select the GPIO1 base address [0x100:0xFFFF] on 1 byte boundary
IO address : CRF1 base address

CRF0 (GP10-GP17 I/O selection register. Default 0xFF)

When set to a '1', respective GPIO port is programmed as an input port.
When set to a '0', respective GPIO port is programmed as an output port.

CRF1 (GP10-GP17 data register. Default 0x00)

If a port is programmed to be an output port, then its respective bit can be read/written
If a port is programmed to be an input port, then its respective bit can only be read.

CRF2 (GP10-GP17 inversion register. Default 0x00)

When set to a '1', the incoming/outgoing port value is inverted.
When set to a '0', the incoming/outgoing port value is the same as in data register.

10.11 Logical Device 8 (MIDI Port and GPIO Port 5)

CR30 (MIDI Port Default 0x00)

Bit 7 - 1 : Reserved.
Bit 0 = 1 MIDI/GP5 port is Activate
= 0 MIDI/GP5 port is inactive.

CR60, CR 61 (Default 0x03, 0x30 if PNPCSV = 0 during POR, default 0x00 otherwise)

These two registers select the MIDI Port base address [0x100:0xFFFF] on 2byte boundary.

CR62, CR 63 (Default 0x00, 0x00)

These two registers select the GPIO5 base address [0x100:0xFFFF] on 4byte boundary.
IO address : CRF1 base address
IO address + 1 : CRF3 base address
IO address + 2 : CRF4 base address
IO address + 3 : CRF5 base address



CR70 (Default 0x09 if PNPCSV = 0 during POR, default 0x00 otherwise)

Bit 7 - 4 : Reserved.

Bit [3:0] : These bits select IRQ resource for MIDI Port .

CRF0 (GP5 selection register. Default 0xFF)

When set to a '1', respective GPIO port is programmed as an input port.

When set to a '0', respective GPIO port is programmed as an output port.

CRF1 (GP5 data register. Default 0x00)

If a port is programmed to be an output port, then its respective bit can be read/written.

If a port is programmed to be an input port, then its respective bit can only be read.

CRF2 (GP5 inversion register. Default 0x00)

When set to a '1', the incoming/outgoing port value is inverted.

When set to a '0', the incoming/outgoing port value is the same as in data register.

CRF3 (PLED mode register. Default 0x00)

Bit 7 ~ 3 : Reserved .

Bit 2 : select WDTO count mode.

= 0 second

= 1 minute

Bit 1 ~ 0 : select PLED mode

= 00 Power LED pin is tri-stated.

= 01 Power LED pin is droved low.

= 10 Power LED pin is a 1Hz toggle pulse with 50 duty cycle.

= 11 Power LED pin is a 1/4Hz toggle pulse with 50 duty cycle.



CRF4 (Default 0x00)

Watch Dog Timer Time-out value. Writing a non-zero value to this register causes the counter to load the value to Watch Dog Counter and start counting down. Reading this register returns current value in Watch Dog Counter instead of Watch Dog Timer Time-out value.

- Bit 7 - 0 = 0x00 Time-out Disable
- = 0x01 Time-out occurs after 1 second/minute
- = 0x02 Time-out occurs after 2 second/minutes
- = 0x03 Time-out occurs after 3 second/minutes
-
- = 0xFF Time-out occurs after 255 second/minutes

CRF5 (Default 0x00)

- Bit 7 ~ 6 : Reserved .
- Bit 5 : Force Watch Dog Timer Time-out, Write only*
 - = 1 Force Watch Dog Timer time-out event; this bit is selfclearing.
- Bit 4 : Watch Dog Timer Status, R/W
 - = 1 Watch Dog Timer time-out occurred.
 - = 0 Watch Dog Timer counting
- Bit 3 - 0 : These bits select IRQ resource for Watch Dog. Setting of 2 selects SMI.

10.12 Logical Device 9 (GPIO Port 2 ~ GPIO Port 4)

CR30 (Default 0x00)

- Bit 7 ~ 3 : Reserved.
- Bit 2 = 1 Activate GPIO4.
 - = 0 GPIO4 is inactive
- Bit 1 = 1 Activate GPIO3.
 - = 0 GPIO3 is inactive
- Bit 0 = 1 Activate GPIO2.
 - = 0 GPIO2 is inactive.

CR60,61(Default 0x00,0x00).

These two registers select the GP2,3,4 base address(0x100:FFE) ON 3 bytes boundary.

- IO address: : CRF1 base address
- IO address + 1 : CRF3 base address
- IO address + 2 : CRF7 base address



CRF0 (GP2 I/O selection register. Default 0xFF)

When set to a '1', respective GPIO port is programmed as an input port.

When set to a '0', respective GPIO port is programmed as an output port.

CRF1 (GP2 data register. Default 0x00)

If a port is programmed to be an output port, then its respective bit can be read/written.

If a port is programmed to be an input port, then its respective bit can only be read.

CRF2 (GP2 inversion register. Default 0x00)

When set to a '1', the incoming/outgoing port value is inverted.

When set to a '0', the incoming/outgoing port value is the same as in data register.

CRF3 (GP3 I/O selection register. Default 0xFF)

When set to a '1', respective GPIO port is programmed as an input port.

When set to a '0', respective GPIO port is programmed as an output port.

CRF4 (GP3 data register. Default 0x00)

If a port is programmed to be an output port, then its respective bit can be read/written.

If a port is programmed to be an input port, then its respective bit can only be read.

CRF5 (GP3 inversion register. Default 0x00)

When set to a '1', the incoming/outgoing port value is inverted.

When set to a '0', the incoming/outgoing port value is the same as in data register.

CRF6 (GP4 I/O selection register. Default 0xFF)

When set to a '1', respective GPIO port is programmed as an input port.

When set to a '0', respective GPIO port is programmed as an output port.

CRF7 (GP4 data register. Default 0x00)

If a port is programmed to be an output port, then its respective bit can be read/written.

If a port is programmed to be an input port, then its respective bit can only be read.

CRF8 (GP5 inversion register. Default 0x00)

When set to a '1', the incoming/outgoing port value is inverted.

When set to a '0', the incoming/outgoing port value is the same as in data register.

10.13 Logical Device A (ACPI)

CR30 (Default 0x00)

- Bit 7 - 1 : Reserved.
- Bit 0 = 1 : Activates the logical device.
- = 0 : Logical device is inactive.

CR70 (Default 0x00)

- Bit 7 - 4 : Reserved.
- Bit 3 - 0 : These bits select IRQ resources for $\overline{\text{SMI}}$ / $\overline{\text{PME}}$

CRE0 (Default 0x00)

- Bit 7 : ENCIRWAKEUP. Enable CIR to wake-up system .
 - = 0 : Disable CIR wake up function
 - = 1 : Enable CIR wake up function
- Bit 5 : CIR_STS. This bit is cleared by reading 1 this register.
 - = 0 : Disable
 - = 1 : Enable
- Bit 6, 4 ~ 0 : Reserved

CRE 1 (Default 0x00) CIR wake up index register

The range of CIR wake up index register is 0x20 ~ px2F .

CRE 2 CIR wake up data register

This register holds the value of wake up key register indicated by CRE1. This register can be read/written.

CRE5 (Default 0x00)

- Bit 7 : Reserved
- Bit 6 ~ 0 : Compared Code Length . When the compared codes are storage in the data register, these data length should be written to this register.

CRE6 (Default 0x00)

- Bit 7 - 6 : Reserved.
- Bit 5 - 0 : CIR Baud Rate Divisor. The clock base of CIR is 32khz, so that the baud rate is 32khz divided by (CIR Baud Rate Divisor + 1).

CRE7 (Default 0x00)

Bit 7 - 3 : Reserved.

Bit 2 :Reset CIR Power-On function. After using CIR power-on, the software should write logical 1 to restart CIR power-on function.

Bit 1 : Invert RX Data.
= 1 Inverting RX Data.
= 0 Not inverting RX Data.

Bit 0 : Enable Demodulation.
= 1 Enable received signal to demodulate.
= 0 Disable received signal to demodulate.

CRF0 (Default 0x00)

- Bit 7 : CHIPPME. Chip level auto power management enable.
= 0 disable the auto power management functions
= 1 enable the auto power management functions.
- Bit 6 : CIRPME. Consumer IR port auto power management enable.
= 0 disable the auto power management functions
= 1 enable the auto power management functions.
- Bit 5 : MIDIPME. MIDI port auto power management enable.
= 0 disable the auto power management functions
= 1 enable the auto power management functions.
- Bit 4 : Reserved. Return zero when read.
- Bit 3 : PRTPME. Printer port auto power management enable.
= 0 disable the auto power management functions.
= 1 enable the auto power management functions
- Bit 2 : FDCPME. FDC auto power management enable.
= 0 disable the auto power management functions.
= 1 enable the auto power management functions.
- Bit 1 : URAPME. UART A auto power management enable.
= 0 disable the auto power management functions.
= 1 enable the auto power management functions.
- Bit 0 : URBPME. UART B auto power management enable.
= 0 disable the auto power management functions.
= 1 enable the auto power management functions.

CRF1 (Default 0x00)

- Bit 7 : WAK_STS. This bit is set when the chip is in the sleeping state and an enabled resume event occurs. Upon setting this bit, the sleeping/working state machine will transition the system to the working state. This bit is only set by hardware and is cleared by writing a 1 to this bit position or by the sleeping/working state machine automatically when the global standby timer expires.
- = 0 the chip is in the sleeping state.
 - = 1 the chip is in the working state.
- Bit 6-5 : Devices' trap status.
- Bit 4 : Reserved. Return zero when read.
- Bit 3-0 : Devices' trap status.

CRF3 (Default 0x00)

- Bit 7~4 : Reserved. Return zero when read.
- Bit 3~0 : Device's IRQ status.
- These bits indicate the IRQ status of the individual device respectively. The device's IRQ status bit is set by their source device and is cleared by writing a 1. Writing a 0 has no effect.
- Bit 3 : PRTIRQSTS. printer port IRQ status.
- Bit 2 : FDCIRQSTS. FDC IRQ status.
- Bit 1 : URAIRQSTS. UART A IRQ status.
- Bit 0 : URBIRQSTS. UART B IRQ status.

CRF4 (Default 0x00)

- Bit 7~4 : Reserved. Return zero when read.
- Bit 3~0 : These bits indicate the IRQ status of the individual GPIO function or logical device respectively. The status bit is set by their source function or device and is cleared by writing a 1. Writing a 0 has no effect.
- Bit 3 : HMIRQSTS. Hardware monitor IRQ status.
- Bit 2 : WDTIRQSTS. Watch dog timer IRQ status.
- Bit 1 : CIRIRQSTS. Consumer IR IRQ status.
- Bit 0 : MIDIRQSTS. MIDI IRQ status.

CRF6 (Default 0x00)

Bit 7~4 : Reserved. Return zero when read.

Bit 3~0 : Enable bits of the $\overline{\text{PME}}/\overline{\text{SMI}}$ generation due to the device's IRQ.

These bits enable the generation of an $\overline{\text{SMI}}/\overline{\text{PME}}$ interrupt due to any IRQ of the devices.

$\overline{\text{SMI}}/\overline{\text{PME}}$ logic output = (PRTIRQEN and PRTIRQSTS) or (FDCIRQEN and FDCIRQSTS)
 or (URAIQEN and URAIQSTS) or (URBIQEN and URBIQSTS) or
 (HMIRQEN and HMIRQSTS) or (WDTIRQEN and WDTIRQSTS) or
 (IRQIN3EN and IRQIN3STS) or (IRQIN2EN and IRQIN2STS) or (IRQIN1EN
 and IRQIN1STS) or (IRQIN0EN and IRQIN0STS)

Bit 3 : PRTIRQEN.

= 0 disable the generation of an $\overline{\text{SMI}}/\overline{\text{PME}}$ interrupt due to printer port's IRQ.

= 1 enable the generation of an $\overline{\text{SMI}}/\overline{\text{PME}}$ interrupt due to printer port's IRQ.

Bit 2 : FDCIRQEN.

= 0 disable the generation of an $\overline{\text{SMI}}/\overline{\text{PME}}$ interrupt due to FDC's IRQ.

= 1 enable the generation of an $\overline{\text{SMI}}/\overline{\text{PME}}$ interrupt due to FDC's IRQ.

Bit 1 : URAIQEN.

= 0 disable the generation of an $\overline{\text{SMI}}/\overline{\text{PME}}$ interrupt due to UART A's IRQ.

= 1 enable the generation of an $\overline{\text{SMI}}/\overline{\text{PME}}$ interrupt due to UART A's IRQ.

Bit 0 : URBIQEN.

= 0 disable the generation of an $\overline{\text{SMI}}/\overline{\text{PME}}$ interrupt due to UART B's IRQ.

= 1 enable the generation of an $\overline{\text{SMI}}/\overline{\text{PME}}$ interrupt due to UART B's IRQ.

CRF7 (Default 0x00)

Bit 7~4 : Reserved. Return zero when read.

Bit 3~0 : Enable bits of the $\overline{\text{SMI}}/\overline{\text{PME}}$ generation due to the GPIO IRQ function or device's IRQ.

Bit 3 : HMIRQEN.

= 0 disable the generation of an $\overline{\text{SMI}}/\overline{\text{PME}}$ interrupt due to hardware monitor's IRQ.

= 1 enable the generation of an $\overline{\text{SMI}}/\overline{\text{PME}}$ interrupt due to hardware monitor's IRQ.

Bit 2 : WDTIRQEN.

= 0 disable the generation of an $\overline{\text{SMI}}/\overline{\text{PME}}$ interrupt due to watch dog timer's IRQ.

= 1 enable the generation of an $\overline{\text{SMI}}/\overline{\text{SMI}}$ interrupt due to watch dog timer's IRQ.



- Bit 1 : CIRIRQEN.
= 0 disable the generation of an $\overline{\text{SMI}}/\overline{\text{PME}}$ interrupt due to CIR's IRQ.
= 1 enable the generation of an $\overline{\text{SMI}}/\overline{\text{PME}}$ interrupt due to CIR's IRQ.
- Bit 0 : MIDIIRQEN.
= 0 disable the generation of an $\overline{\text{SMI}}/\overline{\text{PME}}$ interrupt due to MIDI's IRQ.
= 1 enable the generation of an $\overline{\text{SMI}}/\overline{\text{PME}}$ interrupt due to MIDI's IRQ.

CRF9 (Default 0x00)

- Bit 7- 3 : Reserved. Return zero when read.
- Bit 2 : PME_EN: Select the power management events to be either an $\overline{\text{PME}}$ or $\overline{\text{SMI}}$ interrupt for the IRQ events. Note that: this bit is valid only when SMIPME_OE = 1.
= 0 the power management events will generate an $\overline{\text{SMI}}$ event.
= 1 the power management events will generate an $\overline{\text{PME}}$ event.
- Bit 1 : FSLEEP: This bit selects the fast expiry time of individual devices.
= 0 1 S
= 1 8 mS
- Bit 0 : SMIPME_OE: This is the $\overline{\text{SMI}}$ and $\overline{\text{PME}}$ output enable bit.
= 0 neither $\overline{\text{SMI}}$ nor $\overline{\text{PME}}$ will be generated. Only the IRQ status bit is set.
= 1 an $\overline{\text{SMI}}$ or $\overline{\text{PME}}$ event will be generated.

10.14 Logical Device B (Hardware Monitor)

CR30 (Default 0x00)

- Bit 7- 1 : Reserved.
- Bit 0 = 1 Activates the logical device.
= 0 Logical device is inactive.

CR60, CR 61 (Default 0x00, 0x00)

These two registers select Hardware Monitor base address [0x100:0xFFFF] on 8-byte boundary.

CR70 (Default 0x00)

- Bit 7- 4 : Reserved.
- Bit 3- 0 : These bits select IRQ resource for Hardware Monitor.



11 ORDERING INSTRUCTION

PART NO.	PACKAGE	REMARKS
W83697HF	128-pin QFP	

12 HOW TO READ THE TOP MARKING

Example: The top marking of W83697HF



1st line: Winbond logo

2nd line: the type number: W83697HF

3th line: the tracking code 921 A 2 C 28201234

821: packages made in '98, week 21

A: assembly house ID; A means ASE, S means SPIL.... etc.

2: Winbond internal use.

B: IC revision; A means version A, B means version B

282012345: wafer production series lot number

13 PACKAGE DIMENSIONS (128-pin PQFP)

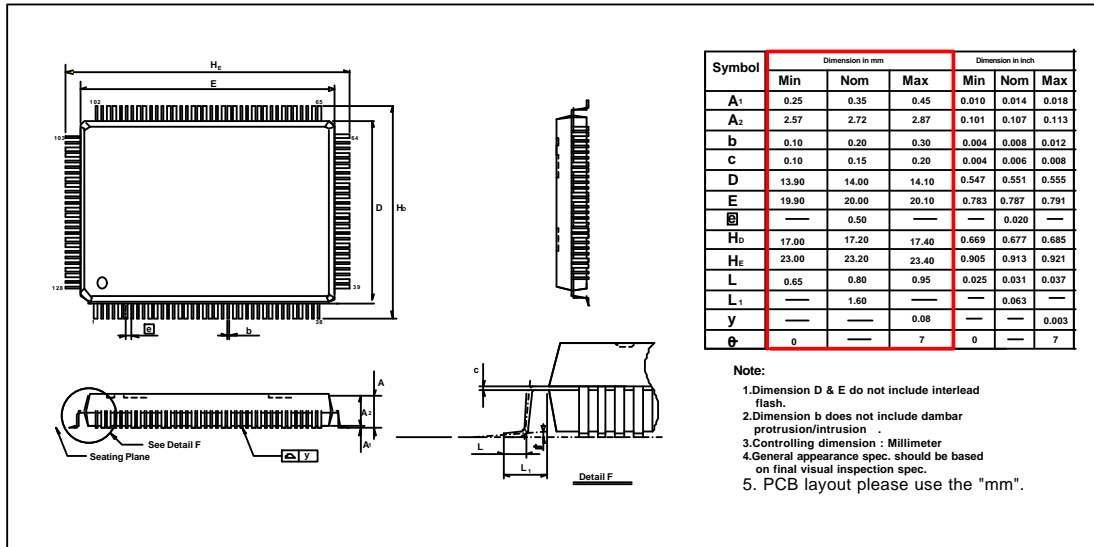

Headquarters

No. 4, Creation Rd. III
Science-Based Industrial Park
Hsinchu, Taiwan
TEL: 886-35-770066
FAX: 886-35-789467
www: <http://www.winbond.com.tw/>

Taipei Office

9F, No. 480, Rueiguang Road, Neihu District,
Taipei, 114, Taiwan
TEL: 886-2-81777168
FAX: 886-2-87153579

Winbond Electronics (H.K.) Ltd.

Rm. 803, World Trade Square, Tower II
123 Hoi Bun Rd., Kwun Tong
Kowloon, Hong Kong
TEL: 852-27516023-7
FAX: 852-27552064

Winbond Electronics

(North America) Corp.

2727 North First Street
San Jose, California 95134
TEL: 1-408-9436666
FAX: 1-408-9436668

Please note that all data and specifications are subject to change without notice. All the trade marks of products and companies mentioned in this data sheet belong to their original owners