

KA2803B

Earth Leakage Detector

Features

- Low Power Consumption $P_D = 5mW$, 100V/200V
- Built-in Voltage Regulator
- High Gain Differential Amplifier
- 0.4mA Output Current Pulse to Trigger SCR' S
- Low External Part Count
- DIP Package (8-DIP), High Packing Density
- High Noise Immunity, Large Surge Margin
- Super Temperature Characteristic of Input Sensitivity
- Wide Operating Temperature Range ($T_A = -25^{\circ}C \sim +80^{\circ}C$)
- Operation from 12 to 20V Input

Functions

- Differential Amplifier
- Level Comparator
- Latch Circuit

Description

The KA2803B is designed for use in earth leakage circuit interrupters, for stable operation of the AC line in breakers. The input of the differential amplifier is connected to the secondary coil of ZCT(Zero Current Transformer). The amplified output of differential amplifier is integrated at external capacitor to gain adequate time delay that is specified in KSC4613. The level comparator generates high level when earth leakage current is greater than the fixed level.

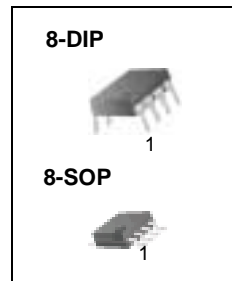

Block Diagram

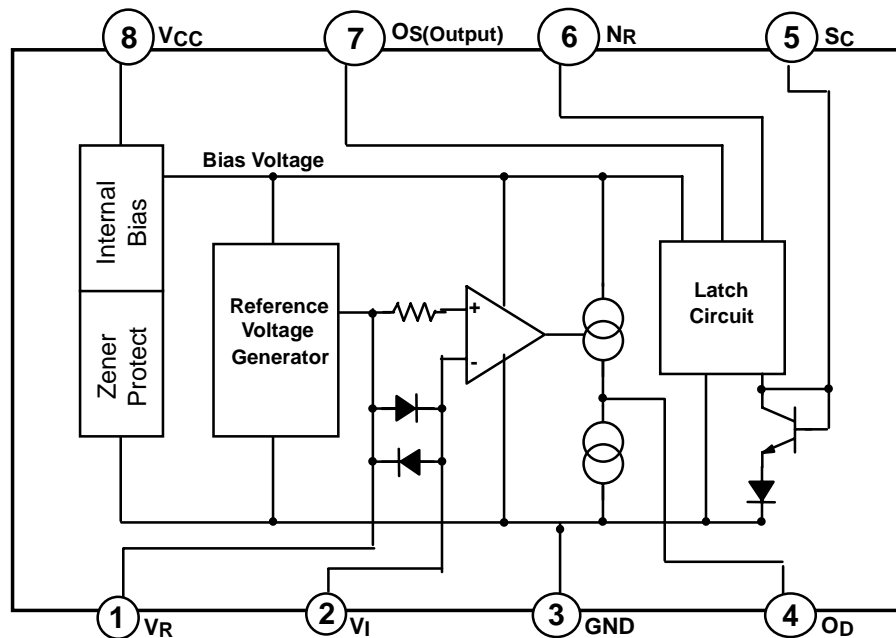

Absolute Maximum Ratings (T_A = 25°C)

Parameter	Symbol	Value	Unit
Supply Voltage	V _{CC}	20	V
Supply Current	I _{CC}	8	mA
Power Dissipation	P _D	300	mW
Lead Temperature (Soldering 10sec)	T _{LEAD}	260	°C
Operating Temperature	T _{OPR}	- 25 ~ +80	°C
Storage Temperature	T _{STG}	- 65 ~ +150	°C

Electrical Characteristics

(T_A = -25°C to 80°C)

Parameter	Symbol	Conditions	Circuit	Min.	Typ.	Max.	Unit	
Supply Current 1	I _{CC}	V _{CC} = 12V V _R = Open V _I = 2V	1	(-25°C)	-	-	580	μA
				(25°C)	300	400	530	
				(80°C)	-	-	480	
Trip Voltage	V _T	V _{CC} = 16V V _R = 2V ~ 2.02V V _I = 2V (Note1)	2	14	16	18	mV	
				12.5	14.2	17	mVrms	
Differential Amplifier Output Current 1	I _{O(D)}	V _{CC} = 16V (V _R -V _I = 30mV , V _{OD} = 1.2V)	3	-12	20	-30	μA	
Differential Amplifier Output Current 2	I _{O(D)}	V _{CC} = 16V, V _{OD} = 0.8V V _R , V _I = V _P (Note2)	4	17	27	37	(rms) μA	
Output Current	I _O	V _{SC} = 1.4V (-25°C) V _{OS} = 0.8V (25°C) V _{CC} = 16V (25°C)	5	200	400	800	μA	
				200	400	800		
				100	300	600		
Latch on Voltage	V _{SCON}	V _{CC} = 16V	6	0.7	1.0	1.4	V	
Latch Input Current	I _{SCON}	V _{CC} = 16V	7	-13	-7	-1	μA	
Output Low Current	I _{OSL}	V _{CC} = 12V, V _{OSL} = 0.2V	8	200	800	1400	μA	
Diff. Input Clamp Voltage	V _{IDC}	V _{CC} = 16V, I _{IDC} = 100mA	9	0.4	1.2	2	V	
Maximum Current Voltage	V _{SM}	I _{SM} = 7mA	10	20	24	28	V	
Supply Current 2	I _{S2}	V _{CC} = 12V, V _{OSL} = 0.6V	11	200	400	900	μA	
Latch Off Supply Voltage	V _{SOFF}	V _{OS} = 12V V _{SC} = 1.8V I _{IDC} = 100mA	12	7.0	8.0	9.0	V	
Response Time(Note1)	T _{ON}	V _{CC} = 16V V _R -V _I = 0.3V , 1V < V _X < 5V	13	2	3	4	mS	

Note:

1. This Parameter, although guaranteed, is not tested in Production.
2. V_P = V_{pin1} - 0.03V at V_{pin2} = 2.0V , V_{pin4} = 1.5V

Test Circuit

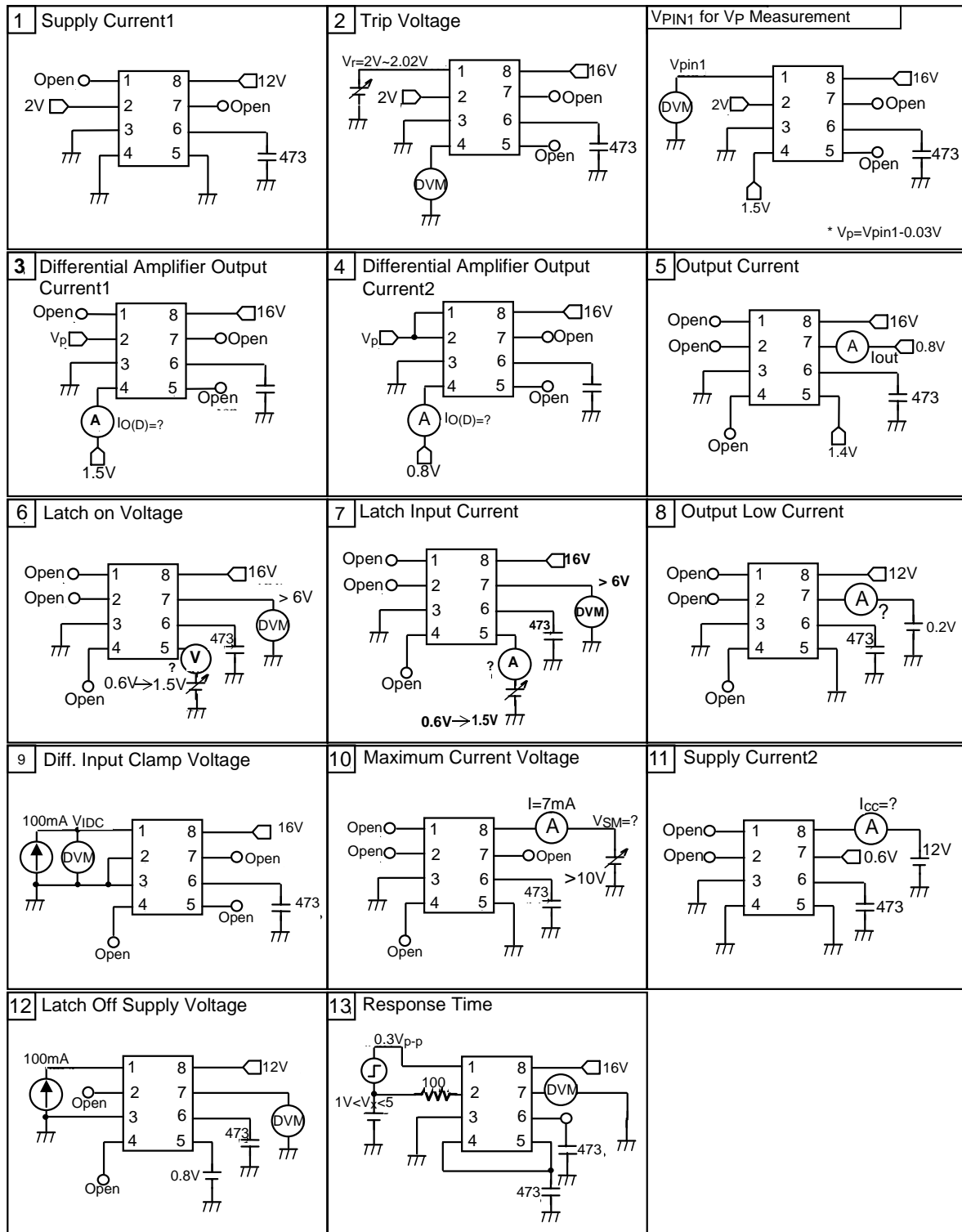

Typical Characteristics

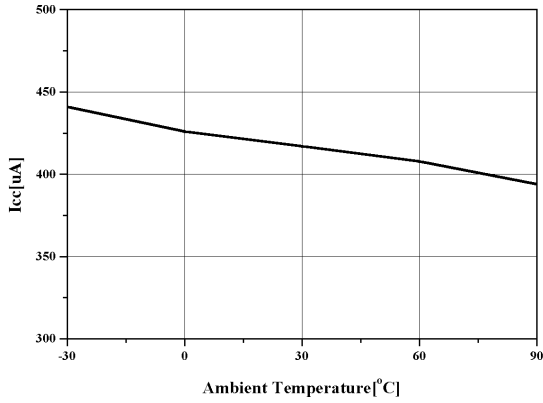

Figure 1. Supply Current

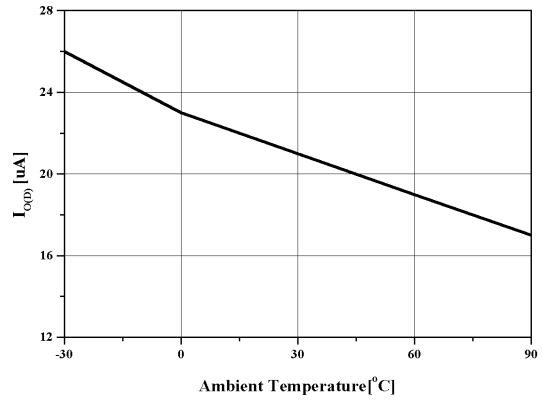

Figure 2. Differential Amp. Output Current
VR-VI=30mV, VOD=1.2V

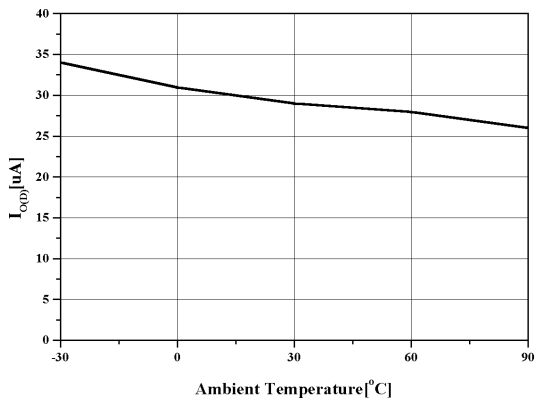

Figure 3. Differential Amp. Output Current
VR, VI=VP, VOD=0.8V

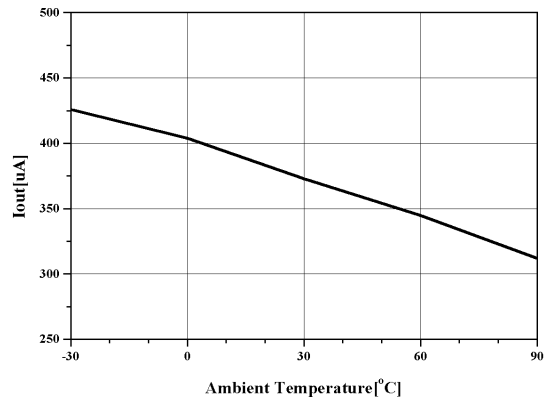

Figure 4. Output Current

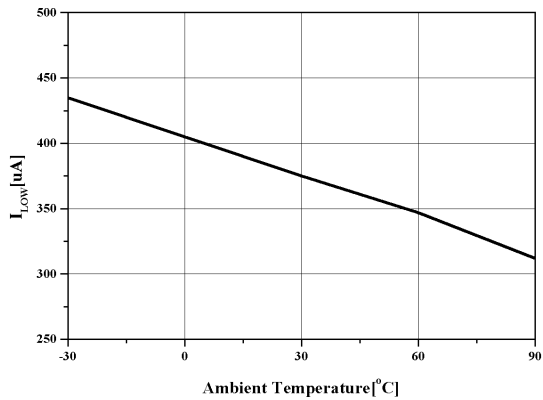

Figure 5. Output Low Current

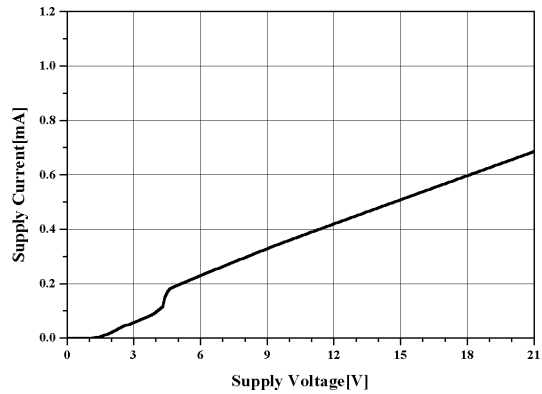

Figure 6. Vcc Voltage Vs. Supply Current 1

Typical Characteristics (Continued)

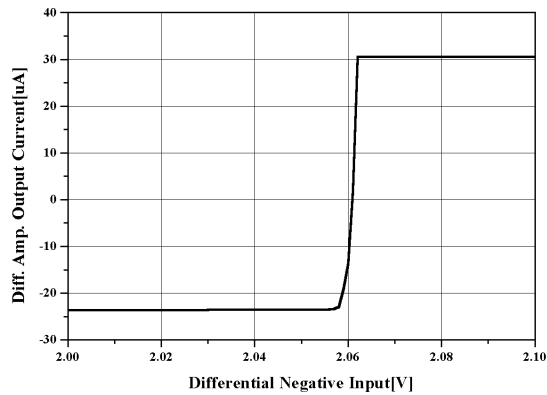

Figure 7. Differential Amp. Output Current 1

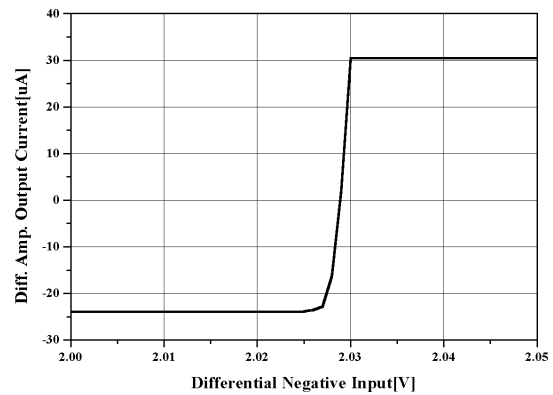

Figure 8. Differential Amp. Output

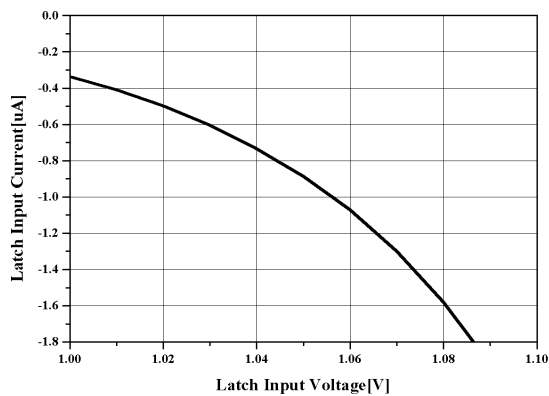

Figure 9. Latch Input Current

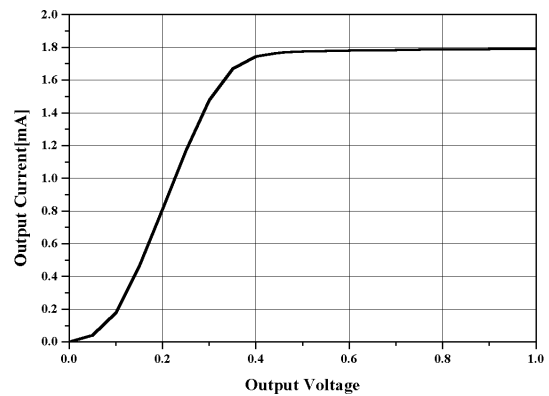

Figure 10. Output Low Current

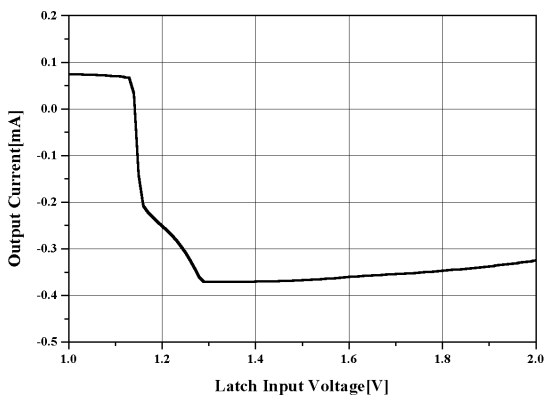

Figure 11. Output Current

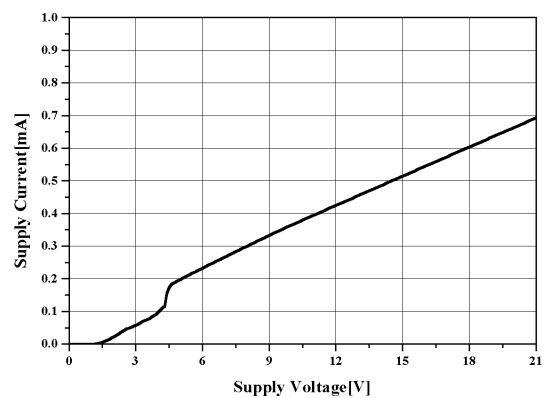

Figure 12. Vcc Voltage Vs. Supply Current 2

Typical Characteristics (Continued)

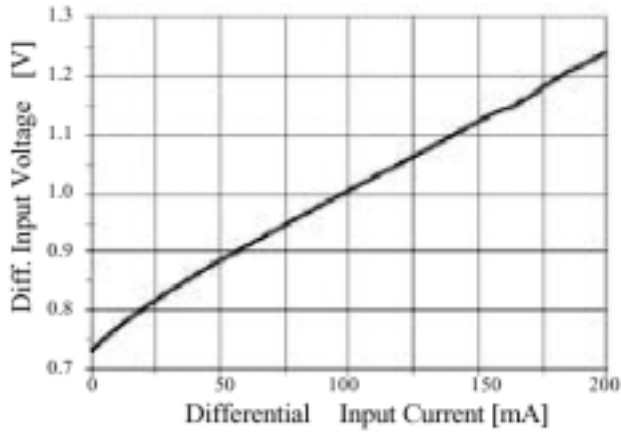

Figure 13. Differential Input Clamp Voltage

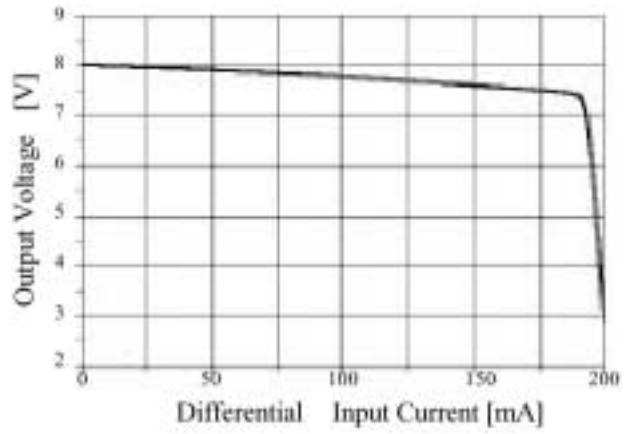

Figure 14. Latch Off Supply Voltage

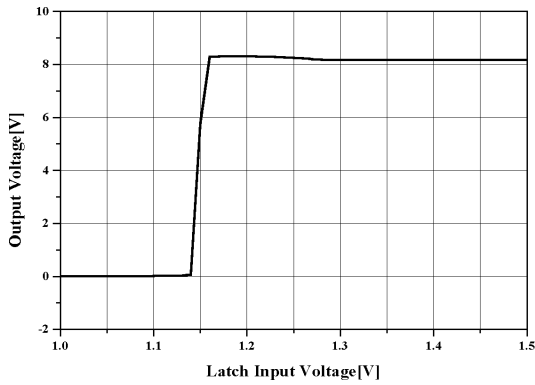

Figure 15. Latch On Input Voltage

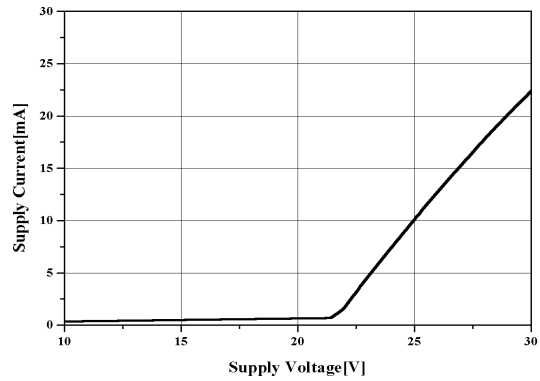

Figure 16. Maximum Supply

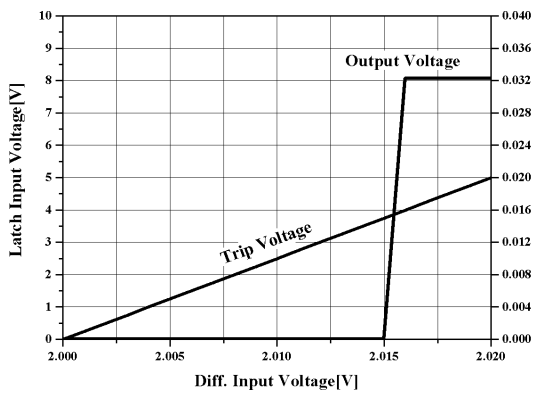

Figure 17. Trip & Output

Typical Characteristics (Continued)

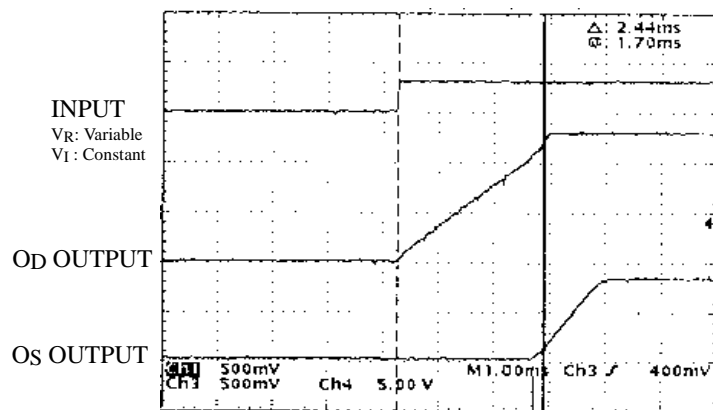

Figure 18. Output Response Time

Application Circuit

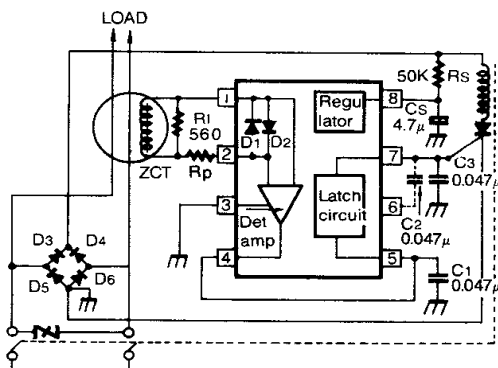

Figure 1. Full Wave Application Circuit

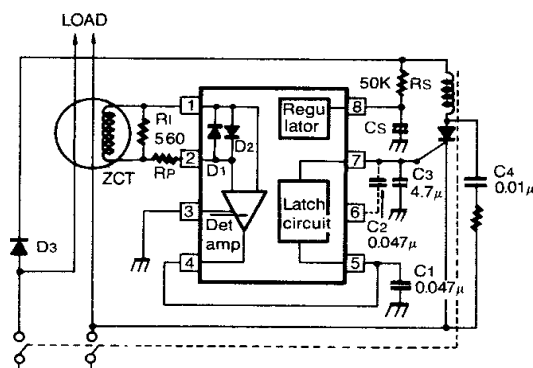

Figure 2. Half Wave Application Circuit

Application Note

(refer to full wave application circuit Fig. 1)

The Fig 1 shows the KA2803B connected in a typical leakage current detector system.

The power is applied to the VCC terminal (Pin 8) of the KA2803B directly from the power line.

The resistor R_S and capacitor C_S are chosen so that pin 8 voltage is at least 12V.

The value of C_S is recommended above $1\mu\text{F}$ at this time.

If the leakage current is at the load, it is detected by the zero current transformer (ZCT).

The output voltage signal of ZCT is amplified by the differential amplifier of the KA2803B internal circuit and appears as half cycle sine wave signal referred to input signal at the output of the amplifier.

The amplifier closed loop gain is fixed about 1000 times with internal feedback resistor to compensate for zero current transformer (ZCT) Variations.

The resistor R_L should be selected so that the breaker satisfies the required sensing current.

The protection resistor R_P is not usually used put when the high current is injected at the breaker, this resistor should be used to protect the earth leakage detector IC the KA2803B.

The range of R_P is from several hundred Ω to several $\text{k}\Omega$.

The capacitor C_1 , is for the noise canceller and standard value of C_1 is $0.047\mu\text{F}$. Also the capacitor C_2 is noise canceller capacitance but it is not usually used.

When high noise is only appeared at this system $0.047\mu\text{F}$ capacitor may be connected between pin 6 and pin 7.

The amplified signal is finally appeared to the Pin 7 with pulse signal through the internal latch circuit of the KA2803B.

This signal drives the gate of the external SCR which energizes the trip coil which opens the circuit breaker.

The trip time of breaker is decided by the capacitor C_3 and the mechanism breaker.

This capacitor should be selected under $1\mu\text{F}$ for the required the trip time.

The full wave bridge supplies power to the KA2803B during both the positive and negative half cycles of the line voltage.

This allows the hot and neutral lines to be interchanged.

If your application want the detail information, request it on our application circuit designer of KA2803B.

Mechanical Dimensions

Package

Dimensions in millimeters

8-DIP

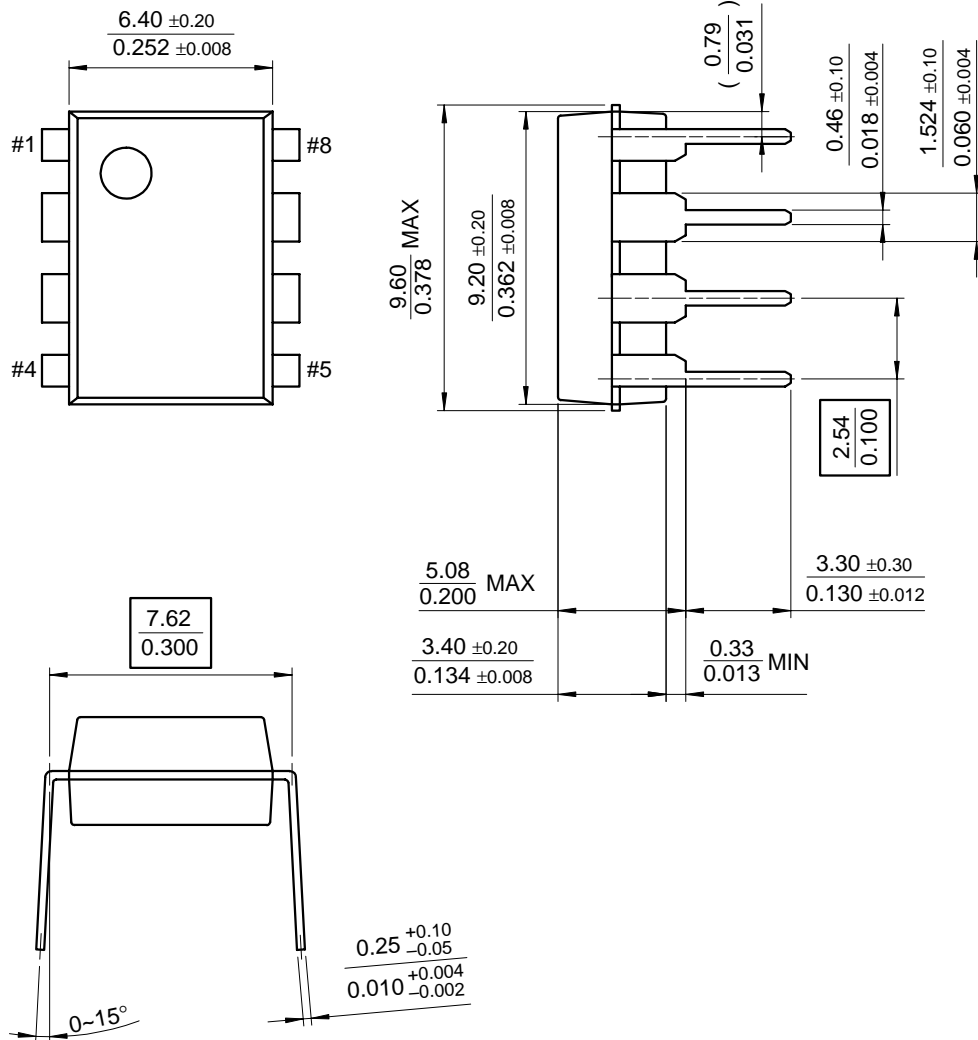

Mechanical Dimensions (Continued)

Package

Dimensions in millimeters

8-SOP

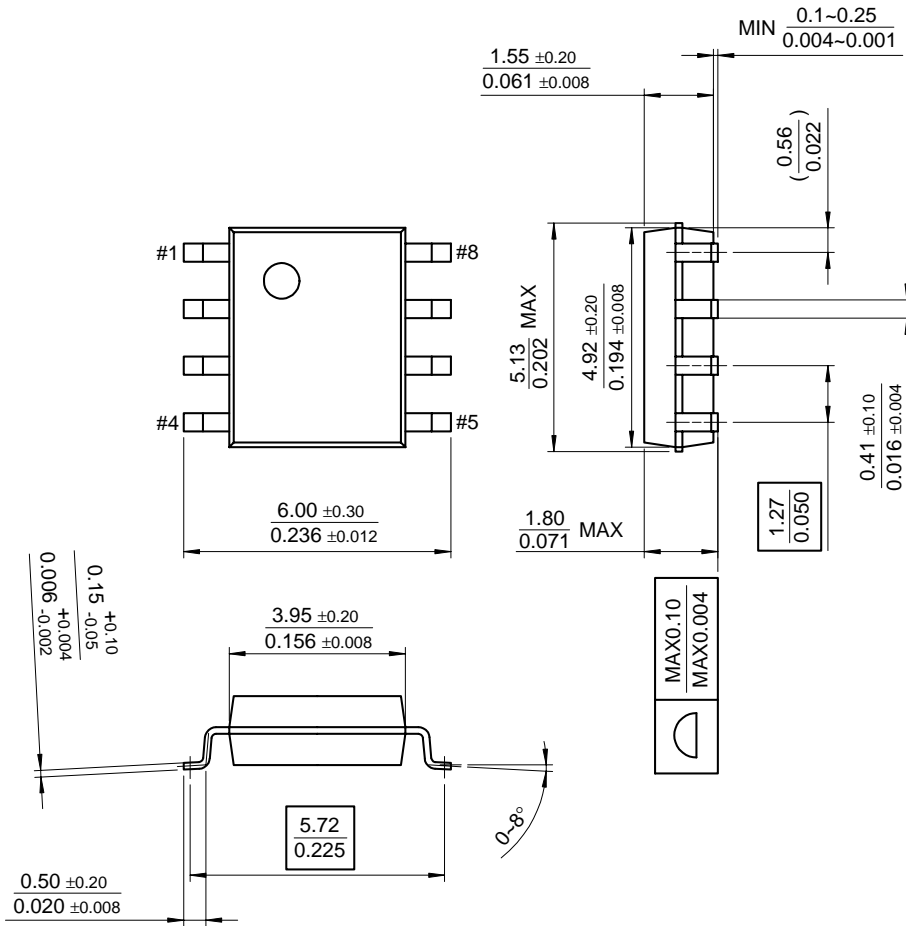

Ordering Information

Product Number	Package	Operating Temperature
KA2803B	8-DIP	-20 ~ +80°C
KA2803BD	8-SOP	

DISCLAIMER

FAIRCHILD SEMICONDUCTOR RESERVES THE RIGHT TO MAKE CHANGES WITHOUT FURTHER NOTICE TO ANY PRODUCTS HEREIN TO IMPROVE RELIABILITY, FUNCTION OR DESIGN. FAIRCHILD DOES NOT ASSUME ANY LIABILITY ARISING OUT OF THE APPLICATION OR USE OF ANY PRODUCT OR CIRCUIT DESCRIBED HEREIN; NEITHER DOES IT CONVEY ANY LICENSE UNDER ITS PATENT RIGHTS, NOR THE RIGHTS OF OTHERS.

LIFE SUPPORT POLICY

FAIRCHILD'S PRODUCTS ARE NOT AUTHORIZED FOR USE AS CRITICAL COMPONENTS IN LIFE SUPPORT DEVICES OR SYSTEMS WITHOUT THE EXPRESS WRITTEN APPROVAL OF THE PRESIDENT OF FAIRCHILD SEMICONDUCTOR CORPORATION. As used herein:

1. Life support devices or systems are devices or systems which, (a) are intended for surgical implant into the body, or (b) support or sustain life, and (c) whose failure to perform when properly used in accordance with instructions for use provided in the labeling, can be reasonably expected to result in a significant injury of the user.
2. A critical component in any component of a life support device or system whose failure to perform can be reasonably expected to cause the failure of the life support device or system, or to affect its safety or effectiveness.