



## Dual N-Channel Enhancement Mode Field Effect Transistor

PRODUCT SUMMARY		
V <sub>DS</sub>	I <sub>D</sub>	R <sub>DS(ON)</sub> (mΩ) Max
55V	4.8A	50 @ V <sub>GS</sub> = 10V
		75 @ V <sub>GS</sub> = 4.5V

### FEATURES

- Super high dense cell design for low R<sub>DS(ON)</sub>.
- Rugged and reliable.
- Surface Mount Package.

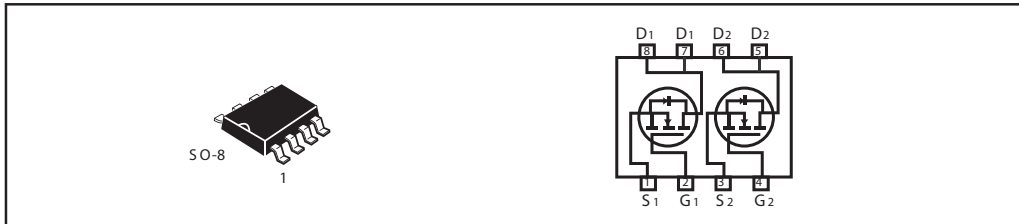

### ABSOLUTE MAXIMUM RATINGS (T<sub>A</sub>=25°C unless otherwise noted)

Parameter	Symbol	Limit	Unit	
Drain-Source Voltage Rating	V <sub>spike</sub> <sup>d</sup>	60	V	
Drain-Source Voltage	V <sub>DS</sub>	55	V	
Gate-Source Voltage	V <sub>GS</sub>	±20	V	
Drain Current-Continuous <sup>a</sup> @ T <sub>a</sub>	I <sub>D</sub>	25°C	4.8	A
		70°C	4.1	A
-Pulsed <sup>b</sup>	I <sub>DM</sub>	25	A	
Drain-Source Diode Forward Current <sup>a</sup>	I <sub>S</sub>	1.7	A	
Maximum Power Dissipation <sup>a</sup>	P <sub>D</sub>	T <sub>a</sub> =25°C	2	W
		T <sub>a</sub> =70°C	1.44	
Operating Junction and Storage Temperature Range	T <sub>J</sub> , T <sub>STG</sub>	-55 to 150	°C	

### THERMAL CHARACTERISTICS

Thermal Resistance, Junction-to-Ambient <sup>a</sup>	R <sub>θJA</sub>	62.5	°C/W
--	------------------	------	------

# STM6930A

ELECTRICAL CHARACTERISTICS (T<sub>A</sub> 25°C unless otherwise noted)

Parameter	Symbol	Condition	Min	Typ <sup>c</sup>	Max	Unit
<b>OFF CHARACTERISTICS</b>						
Drain-Source Breakdown Voltage	B <sub>VDS</sub>	V <sub>GS</sub> = 0V, I <sub>D</sub> = 250uA	55			V
Zero Gate Voltage Drain Current	I <sub>DSS</sub>	V <sub>DS</sub> = 44V, V <sub>GS</sub> = 0V			1	uA
Gate-Body Leakage	I <sub>GSS</sub>	V <sub>GS</sub> = ±20V, V <sub>DS</sub> = 0V			±100	nA
<b>ON CHARACTERISTICS<sup>b</sup></b>						
Gate Threshold Voltage	V <sub>GS(th)</sub>	V <sub>DS</sub> = V <sub>GS</sub> , I <sub>D</sub> = 250uA	1.0	1.8	2.5	V
Drain-Source On-State Resistance	R <sub>DS(ON)</sub>	V <sub>GS</sub> = 10V, I <sub>D</sub> = 4.5A		38	50	m ohm
		V <sub>GS</sub> = 4.5V, I <sub>D</sub> = 3A		60	75	m ohm
On-State Drain Current	I <sub>D(ON)</sub>	V <sub>DS</sub> = 5V, V <sub>GS</sub> = 10V	20			A
Forward Transconductance	g <sub>FS</sub>	V <sub>DS</sub> = 5V, I <sub>D</sub> = 4.5A		7		S
<b>DYNAMIC CHARACTERISTICS<sup>c</sup></b>						
Input Capacitance	C <sub>ISS</sub>	V <sub>DS</sub> = 25V, V <sub>GS</sub> = 0V f = 1.0MHz		700	805	pF
Output Capacitance	C <sub>OSS</sub>			82	95	pF
Reverse Transfer Capacitance	C <sub>RSS</sub>			50	58	pF
Gate resistance	R <sub>g</sub>	V <sub>GS</sub> = 0V, V <sub>DS</sub> = 0V, f = 1.0MHz		5		ohm
<b>SWITCHING CHARACTERISTICS<sup>c</sup></b>						
Turn-On Delay Time	t <sub>D(ON)</sub>	V <sub>DD</sub> = 30V I <sub>D</sub> = 4.5 A V <sub>GS</sub> = 10V R <sub>GEN</sub> = 6 ohm		3.2	3.8	ns
Rise Time	t <sub>r</sub>			10.1	12	ns
Turn-Off Delay Time	t <sub>D(OFF)</sub>			13.3	15.3	ns
Fall Time	t <sub>f</sub>			8.3	9.6	ns
Total Gate Charge	Q <sub>g</sub>	V <sub>DS</sub> = 48V, I <sub>D</sub> = 4.5A, V <sub>GS</sub> = 10V		17.3	20	nC
		V <sub>DS</sub> = 48V, I <sub>D</sub> = 4.5A, V <sub>GS</sub> = 4.5V		8.1	9.5	nC
Gate-Source Charge	Q <sub>gs</sub>	V <sub>DS</sub> = 48V, I <sub>D</sub> = 4.5 A V <sub>GS</sub> = 10V		1.8	2.2	nC
Gate-Drain Charge	Q <sub>gd</sub>			4.2	4.9	nC

# STM6930A

## ELECTRICAL CHARACTERISTICS ( $T_A=25^\circ\text{C}$ unless otherwise noted)

Parameter	Symbol	Condition	Min	Typ <sup>c</sup>	Max	Unit
DRAIN-SOURCE DIODE CHARACTERISTICS <sup>b</sup>						
Diode Forward Voltage	$V_{SD}$	$V_{GS} = 0V, I_S = 1.7A$		0.8	1.2	V

### Notes

- a. Surface Mounted on FR4 Board,  $t \leq 10\text{sec}$ .
- b. Pulse Test: Pulse Width  $\leq 300\mu\text{s}$ , Duty Cycle  $\leq 2\%$ .
- c. Guaranteed by design, not subject to production testing.
- d. Guaranteed when external  $R_g = 6\ \text{ohm}$  and  $t_f < t_f \text{ max}$

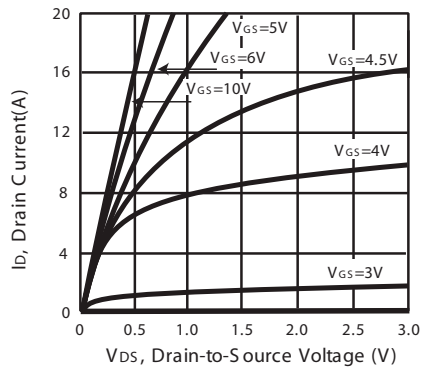

Figure 1. Output Characteristics

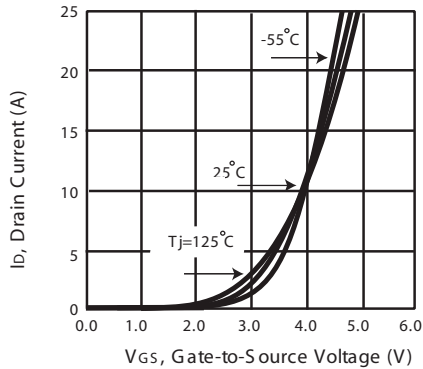

Figure 2. Transfer Characteristics

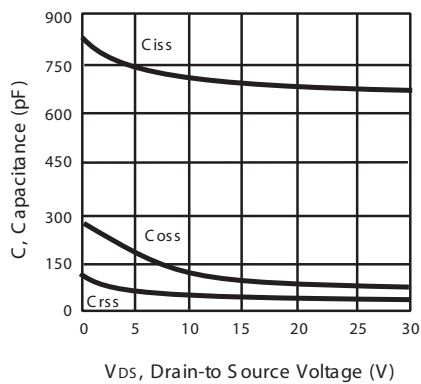

Figure 3. Capacitance

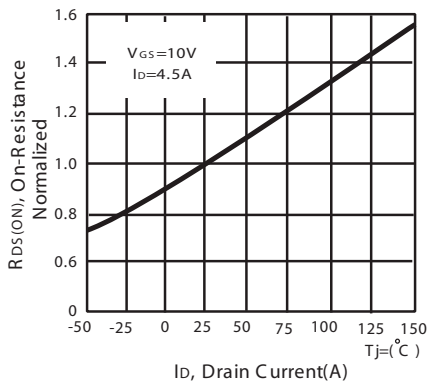

Figure 4. On-Resistance Variation with Drain Current and Temperature

# STM6930A

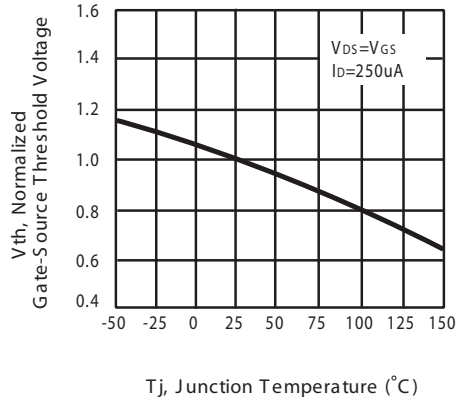

Figure 5. Gate Threshold Variation with Temperature

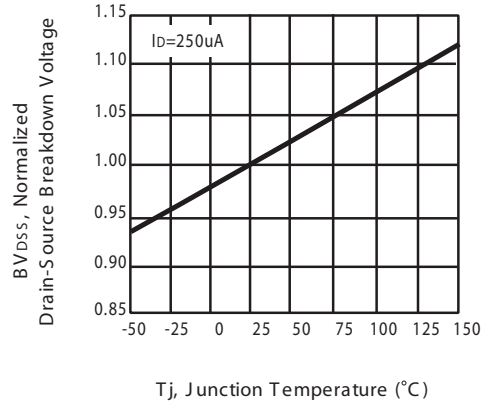

Figure 6. Breakdown Voltage Variation with Temperature

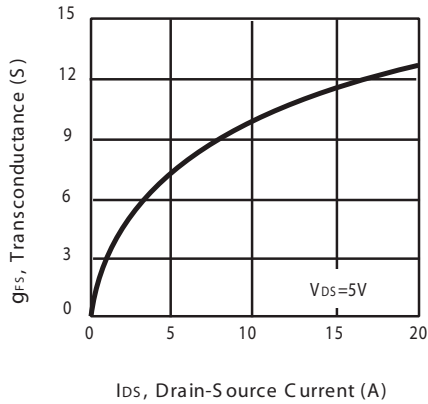

Figure 7. Transconductance Variation with Drain Current

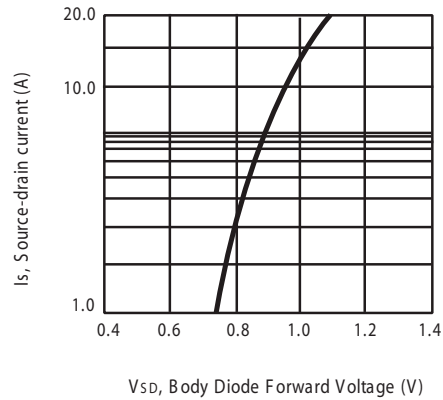

Figure 8. Body Diode Forward Voltage Variation with Source Current

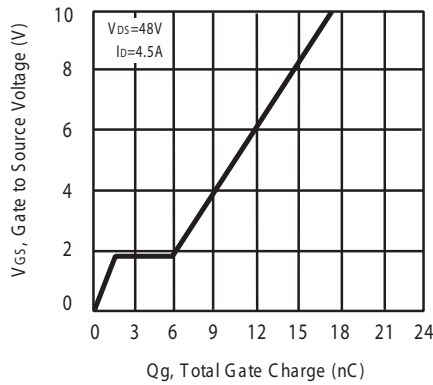

Figure 9. Gate Charge

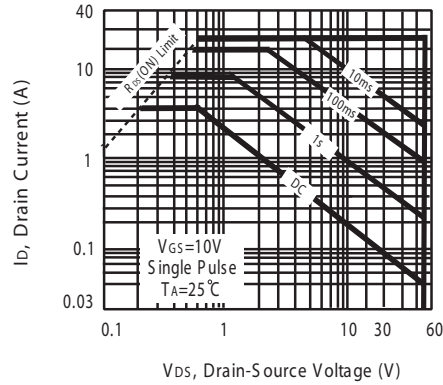

Figure 10. Maximum Safe Operating Area

# STM6930A

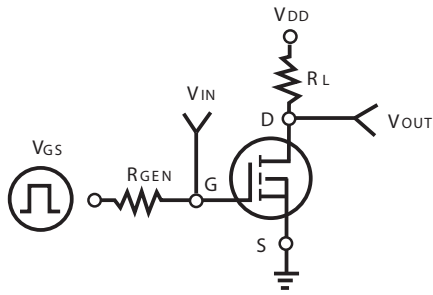

Figure 11. Switching Test Circuit

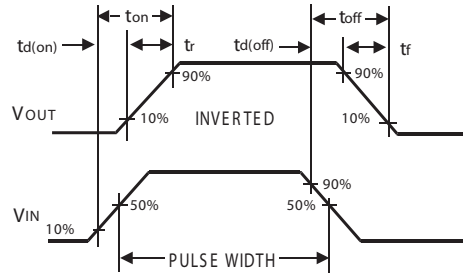
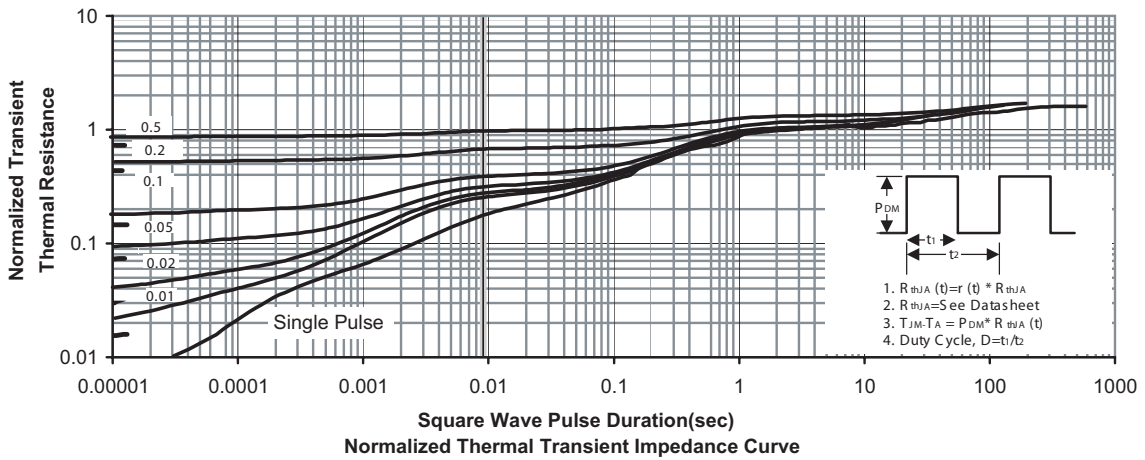

Figure 12. Switching Waveforms



# STM6930A

## PACKAGE OUTLINE DIMENSIONS

SO-8

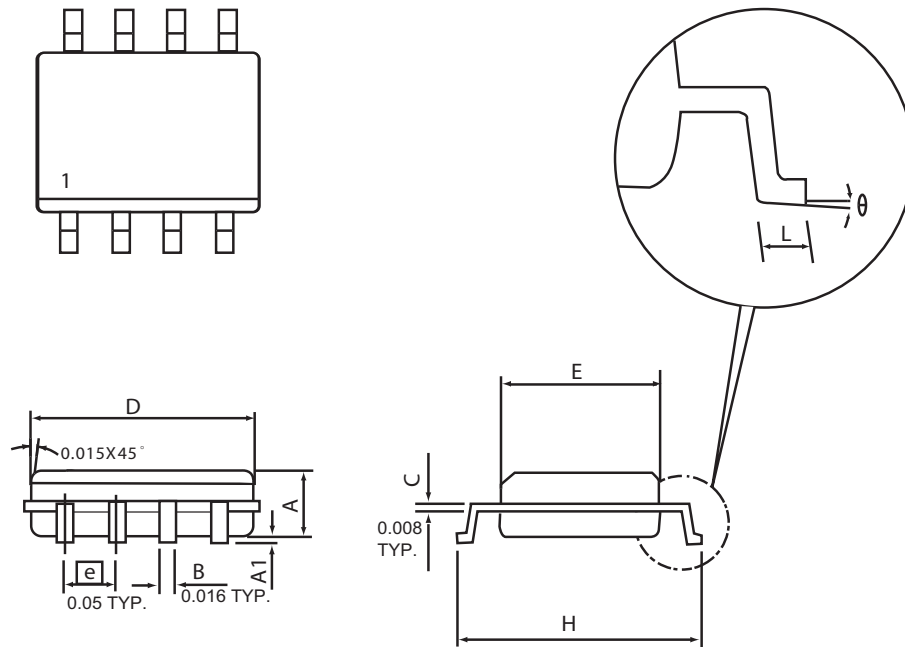

SYMBOLS	MILLIMETERS		INCHES	
	MIN	MAX	MIN	MAX
A	1.35	1.75	0.053	0.069
A1	0.10	0.25	0.004	0.010
D	4.80	4.98	0.189	0.196
E	3.81	3.99	0.150	0.157
H	5.79	6.20	0.228	0.244
L	0.41	1.27	0.016	0.050
$\theta$	0°	8°	0°	8°

# STM6930A

## SO-8 Tape and Reel Data

### SO-8 Carrier Tape

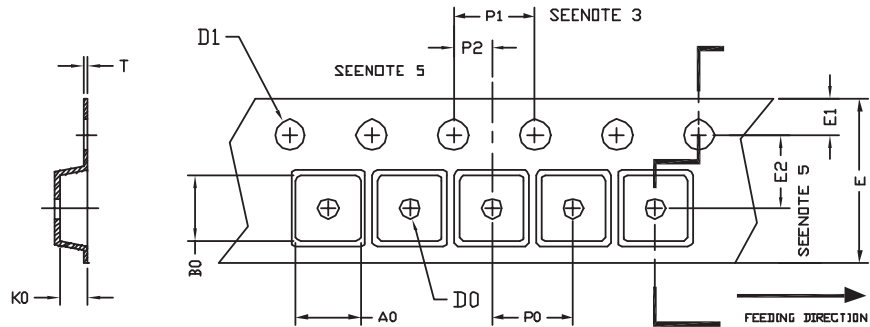

unit:mm

PACKAGE	A0	B0	K0	D0	D1	E	E1	E2	P0	P1	P2	T
SOP 8N 150mil	6.40	5.20	2.10	$\phi 1.5$ (MIN)	$\phi 1.5$ +0.1 -0.0	12.0 $\pm 0.3$	1.75	5.5 $\pm 0.05$	8.0	4.0	2.0 $\pm 0.05$	0.3 $\pm 0.05$

### SO-8 Reel

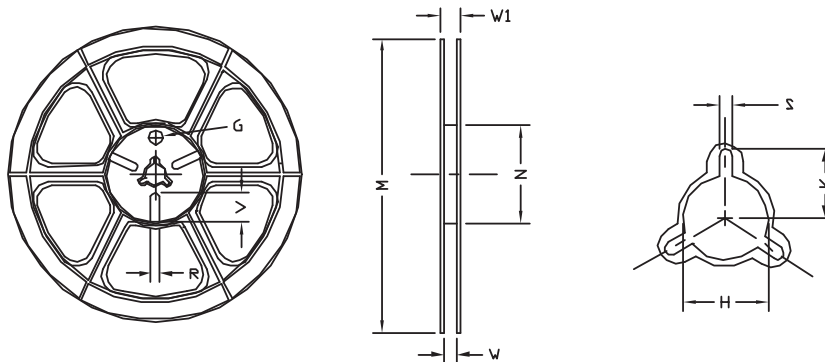

UNIT:mm

TAPE SIZE	REEL SIZE	M	N	W	W1	H	K	S	G	R	V
12 mm	$\phi 330$	330 $\pm 1$	62 $\pm 1.5$	12.4 +0.2	16.8 -0.4	$\phi 12.75$ +0.15	---	2.0 $\pm 0.15$	---	---	---