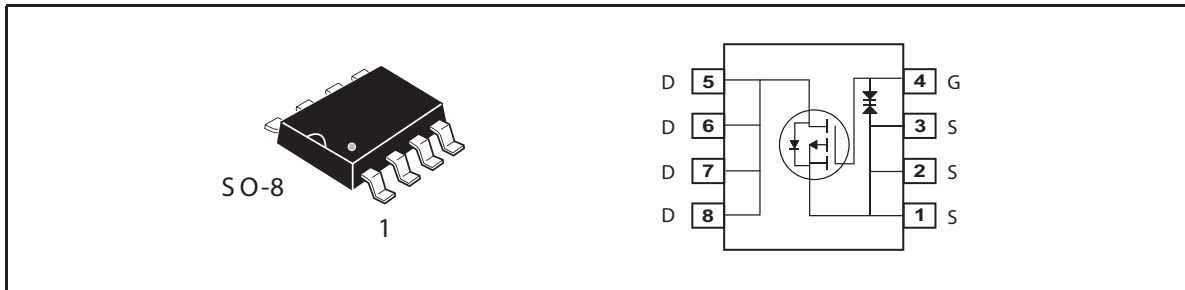

**P-Channel Enhancement Mode Field Effect Transistor****PRODUCT SUMMARY**

V <sub>DSS</sub>	I <sub>D</sub>	R <sub>DS(ON)</sub> (mΩ) Max
-60V	-4A	86 @ V <sub>GS</sub> =-10V
		125 @ V <sub>GS</sub> =-4.5V

**FEATURES**

- Super high dense cell design for low R<sub>DS(ON)</sub>.
- Rugged and reliable.
- Surface Mount Package.

**ABSOLUTE MAXIMUM RATINGS (T<sub>A</sub>=25°C unless otherwise noted)**

Symbol	Parameter	Limit	Units
V <sub>DS</sub>	Drain-Source Voltage	-60	V
V <sub>GS</sub>	Gate-Source Voltage	±20	V
I <sub>D</sub>	Drain Current-Continuous <sup>a</sup>	T <sub>A</sub> =25°C	-4
		T <sub>A</sub> =70°C	-3.2
I <sub>DM</sub>	-Pulsed <sup>b</sup>	-22	A
E <sub>AS</sub>	Single Pulse Avalanche Energy <sup>d</sup>	49	mJ
P <sub>D</sub>	Maximum Power Dissipation <sup>a</sup>	T <sub>A</sub> =25°C	2.5
		T <sub>A</sub> =70°C	1.6
T <sub>J</sub> , T <sub>STG</sub>	Operating Junction and Storage Temperature Range	-55 to 150	°C

**THERMAL CHARACTERISTICS**

R <sub>θJA</sub>	Thermal Resistance, Junction-to-Ambient <sup>a</sup>	50	°C/W
------------------	--	----	------

# STM6967

Ver 1.0

## ELECTRICAL CHARACTERISTICS (T<sub>A</sub>=25°C unless otherwise noted)

Symbol	Parameter	Conditions	Min	Typ	Max	Units
<b>OFF CHARACTERISTICS</b>						
BV <sub>DSS</sub>	Drain-Source Breakdown Voltage	V <sub>GS</sub> =0V, I <sub>D</sub> =-250uA	-60			V
I <sub>DSS</sub>	Zero Gate Voltage Drain Current	V <sub>DS</sub> =-48V, V <sub>GS</sub> =0V			-1	uA
I <sub>GSS</sub>	Gate-Body Leakage Current	V <sub>GS</sub> = ±20V, V <sub>DS</sub> =0V			±10	uA
<b>ON CHARACTERISTICS</b>						
V <sub>GS(th)</sub>	Gate Threshold Voltage	V <sub>DS</sub> =V <sub>GS</sub> , I <sub>D</sub> =-250uA	-2.0	-2.4	-4.0	V
R <sub>DS(ON)</sub>	Drain-Source On-State Resistance	V <sub>GS</sub> =-10V, I <sub>D</sub> =-4A		69	86	m ohm
		V <sub>GS</sub> =-4.5V, I <sub>D</sub> =-3.3A		93	125	m ohm
g <sub>FS</sub>	Forward Transconductance	V <sub>DS</sub> =-5V, I <sub>D</sub> =-4A		15		S
<b>DYNAMIC CHARACTERISTICS <sup>c</sup></b>						
C <sub>ISS</sub>	Input Capacitance	V <sub>DS</sub> =-15V, V <sub>GS</sub> =0V f=1.0MHz		1110		pF
C <sub>OSS</sub>	Output Capacitance			79		pF
C <sub>RSS</sub>	Reverse Transfer Capacitance			56		pF
<b>SWITCHING CHARACTERISTICS <sup>c</sup></b>						
t <sub>D(ON)</sub>	Turn-On Delay Time	V <sub>DD</sub> =-15V		23		ns
t <sub>r</sub>	Rise Time	I <sub>D</sub> =-1A		19		ns
t <sub>D(OFF)</sub>	Turn-Off Delay Time	V <sub>GS</sub> =-10V		71		ns
t <sub>f</sub>	Fall Time	R <sub>GEN</sub> = 6 ohm		37		ns
Q <sub>g</sub>	Total Gate Charge	V <sub>DS</sub> =-15V, I <sub>D</sub> =-4A, V <sub>GS</sub> =-10V		24		nC
		V <sub>DS</sub> =-15V, I <sub>D</sub> =-4A, V <sub>GS</sub> =-4.5V		11.5		nC
Q <sub>gs</sub>	Gate-Source Charge	V <sub>DS</sub> =-15V, I <sub>D</sub> =-4A,		2.9		nC
Q <sub>gd</sub>	Gate-Drain Charge	V <sub>GS</sub> =-10V		6.2		nC
<b>DRAIN-SOURCE DIODE CHARACTERISTICS AND MAXIMUM RATINGS</b>						
V <sub>SD</sub>	Diode Forward Voltage	V <sub>GS</sub> =0V, I <sub>S</sub> =-1A		-0.79	-1.2	V
<b>Notes</b> a.Surface Mounted on FR4 Board,t ≤ 10sec. b.Pulse Test:Pulse Width ≤ 300us, Duty Cycle ≤ 2%. c.Guaranteed by design, not subject to production testing. d.Starting T <sub>J</sub> =25°C,L=0.5mH,V <sub>DD</sub> = 30V.(See Figure13)						

Apr,28,2010

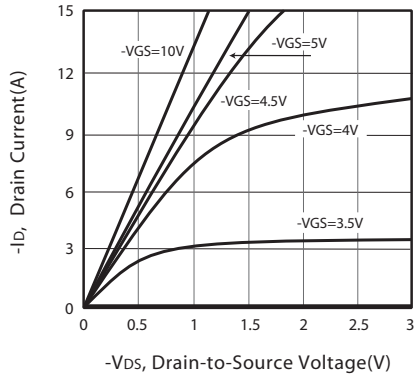

Figure 1. Output Characteristics

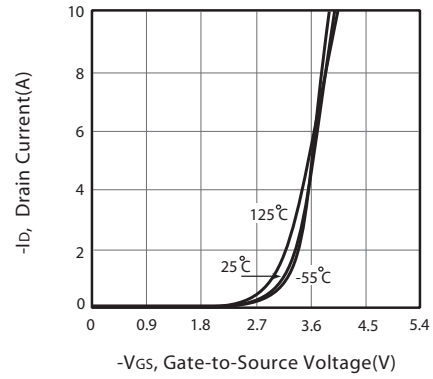

Figure 2. Transfer Characteristics

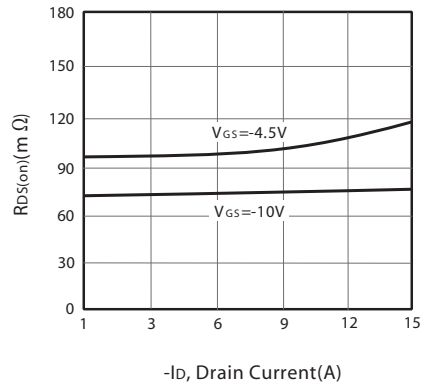

Figure 3. On-Resistance vs. Drain Current and Gate Voltage

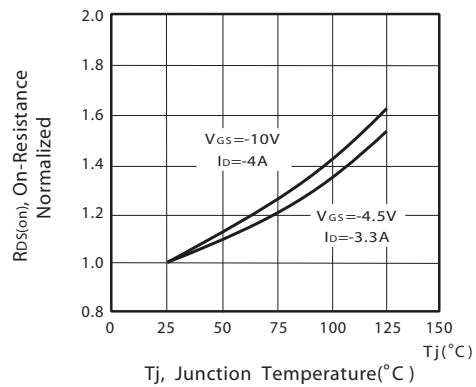

Figure 4. On-Resistance Variation with Drain Current and Temperature

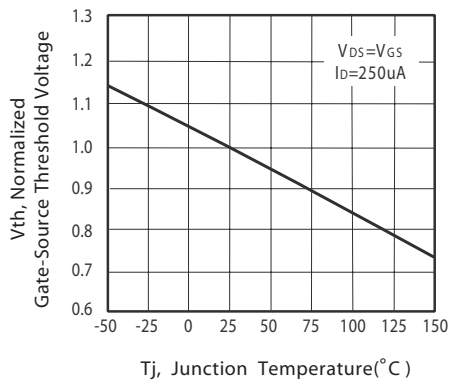

Figure 5. Gate Threshold Variation with Temperature

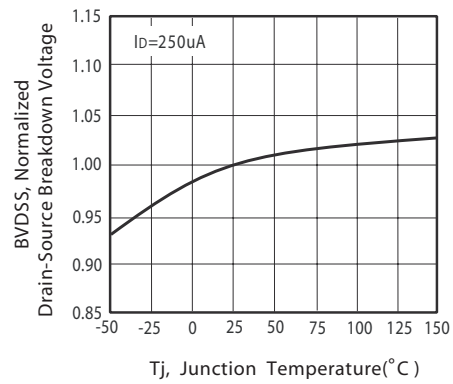

Figure 6. Breakdown Voltage Variation with Temperature

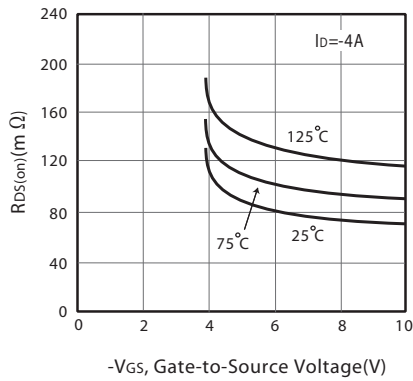

Figure 7. On-Resistance vs. Gate-Source Voltage

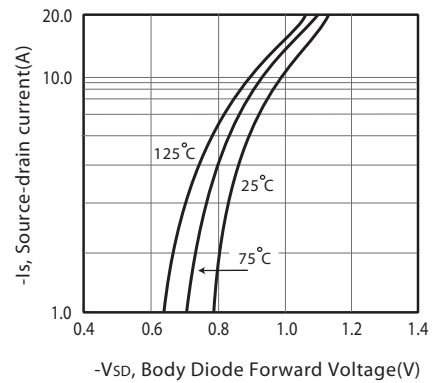

Figure 8. Body Diode Forward Voltage Variation with Source Current

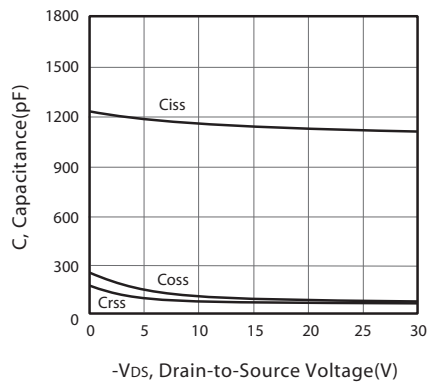

Figure 9. Capacitance

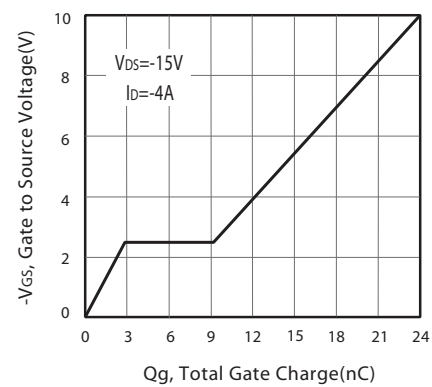

Figure 10. Gate Charge

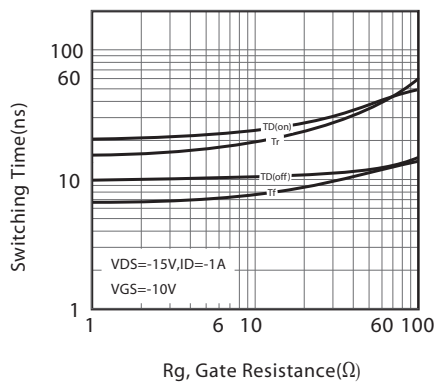

Figure 11. switching characteristics

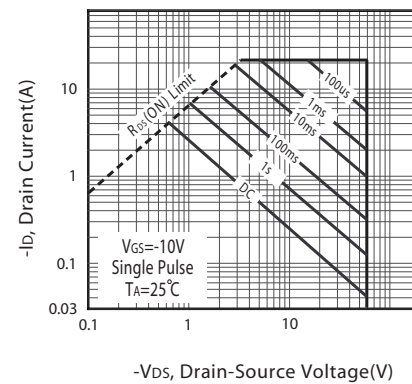
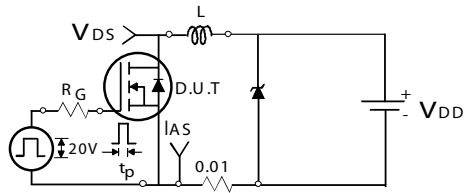
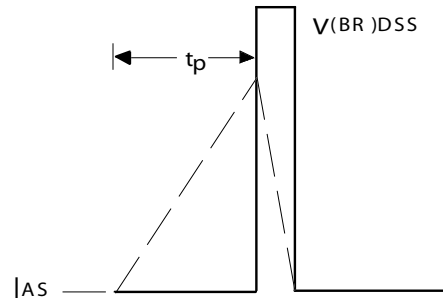

Figure 12. Maximum Safe Operating Area



Unclamped Inductive Test Circuit

Figure 13a.



Unclamped Inductive Waveforms

Figure 13b.

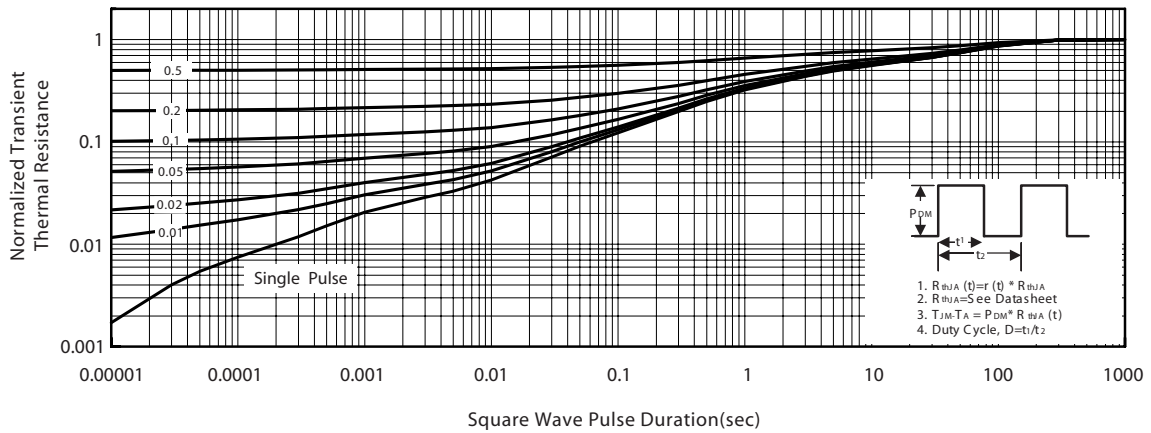
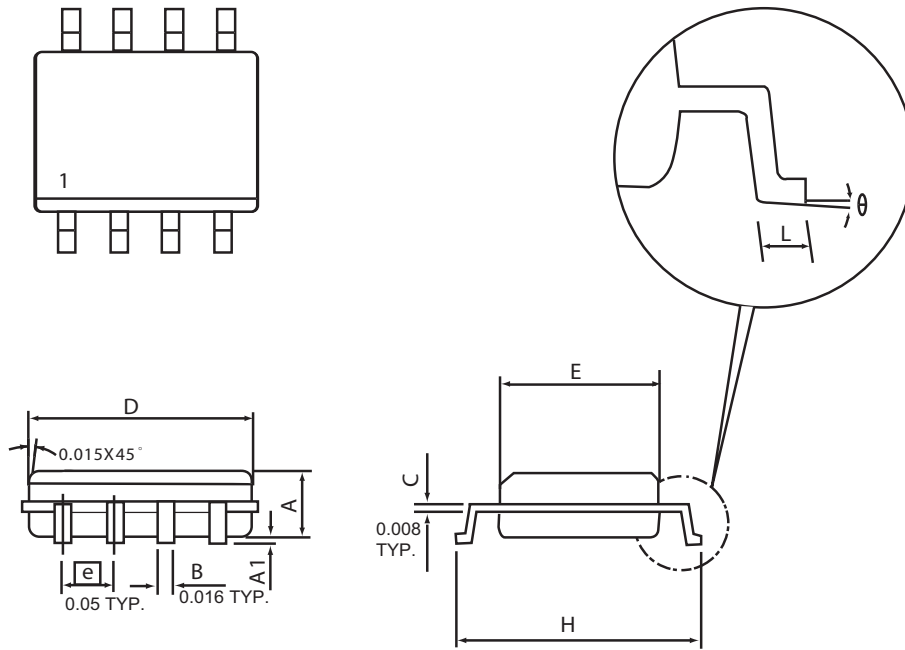

Figure 14. Normalized Thermal Transient Impedance Curve

## PACKAGE OUTLINE DIMENSIONS

### SO-8



SYMBOLS	MILLIMETERS		INCHES	
	MIN	MAX	MIN	MAX
A	1.35	1.75	0.053	0.069
A1	0.10	0.25	0.004	0.010
D	4.80	4.98	0.189	0.196
E	3.81	3.99	0.150	0.157
H	5.79	6.20	0.228	0.244
L	0.41	1.27	0.016	0.050
θ	0°	8°	0°	8°

## SO-8 Tape and Reel Data

### SO-8 Carrier Tape

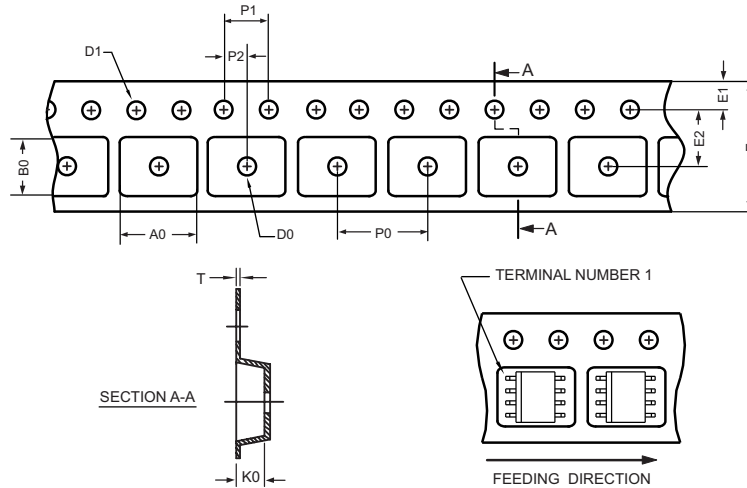

unit:mm

PACKAGE	A0	B0	K0	D0	D1	E	E1	E2	P0	P1	P2	T
SOP 8N 150mil	6.50 ±0.15	5.25 ±0.10	2.10 ±0.10	φ 1.5 (MIN)	φ 1.55 ±0.10	12.0 +0.3 -0.1	1.75 ±0.10	5.5 ±0.10	8.0 ±0.10	4.0 ±0.10	2.0 ±0.10	0.30 ±0.013

### SO-8 Reel

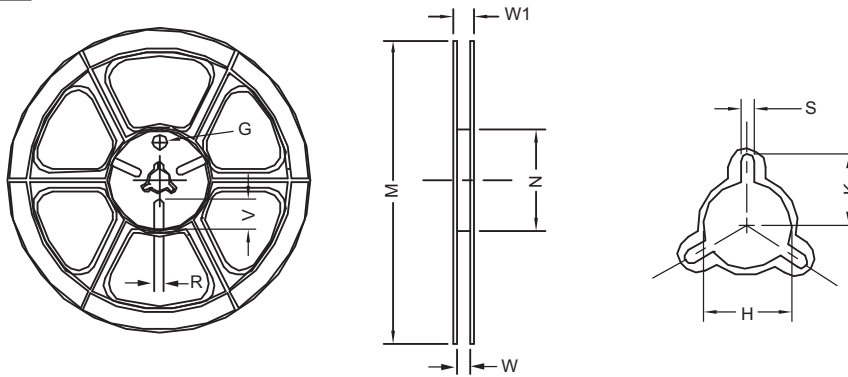

UNIT:mm

TAPE SIZE	REEL SIZE	M	N	W	W1	H	K	S	G	R	V
12 mm	φ 330	330 ± 1	62 ±1.5	12.4 + 0.2	16.8 - 0.4	φ 12.75 + 0.15	---	2.0 ±0.15	---	---	---