

**150mA RF ULDO REGULATOR WITH ERROR FLAG****AP2203****General Description**

The AP2203 is a 150mA ULDO regulator, which provides ultra low dropout voltage (typically 165mV at 150mA), very low quiescent current (1 μ A maximum) in shutdown mode and excellent power supply ripple rejection (PSRR 75dB at 100Hz) in battery powered applications, such as handsets and PDAs and in noise sensitive applications, such as RF electronics.

The AP2203 also features an undervoltage monitor with an error flag output, logic compatible enable/shutdown control inputs, a low power shutdown mode for extended battery life, over current protection, over temperature protection as well as reversed-battery protection.

The AP2203 has 2.5V, 3.0V and 3.3V versions.

The AP2203 is available in space saving 5-pin SOT-23-5 package.

Features

- Error Flag to Indicate Undervoltage Fault
- Up to 150mA Regulator Output
- Low Quiescent Current
- Low Dropout Voltage: $V_{DROPO}=165\text{mV}$ at 150mA
- High Output Accuracy: $\pm 1\%$
- Good Ripple Rejection Ability: 75dB at 100Hz and $I_{OUT}=100\mu\text{A}$
- Tight Load and Line Regulation
- Low Temperature Coefficient
- Over Current Protection
- Thermal Protection
- Reverse-battery Protection
- Zero Off-mode Current
- Logic-controlled Enable

Applications

- Cellular Phones
- Cordless Phones
- Wireless Communicators
- PDAs / Palmtops
- Consumer Electronics

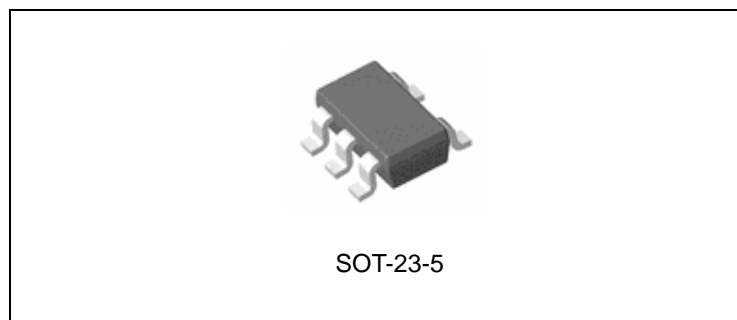

Figure 1. Package Type of AP2203

**150mA RF ULDO REGULATOR WITH ERROR FLAG****AP2203****Pin Configuration**

Figure 2. Pin Configuration of AP2203 (Top View)

Pin Description

Pin Number	Pin Name	Function
1	V _{IN}	Input voltage
2	GND	Ground
3	EN	Enable input: CMOS or TTL compatible input. Logic high=enable, logic low=shutdown
4	FLAG	Error flag (Output pin): Open-collector output. Active low indicates an output undervoltage condition
5	V _{OUT}	Regulated output voltage

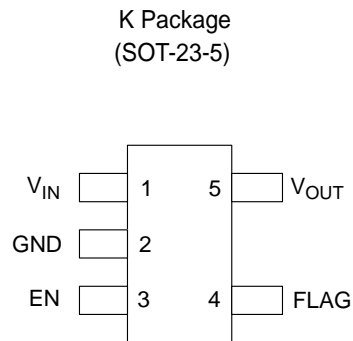

150mA RF ULDO REGULATOR WITH ERROR FLAG

AP2203

Functional Block Diagram

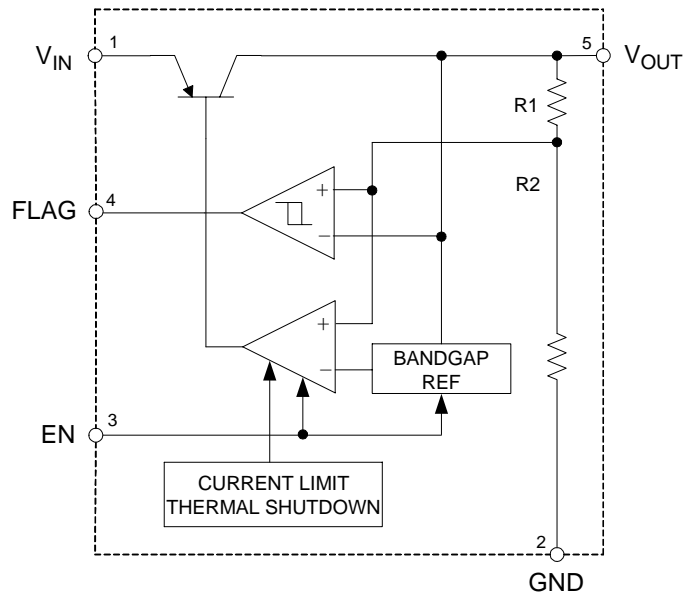

Figure 3. Functional Block Diagram of AP2203



150mA RF ULDO REGULATOR WITH ERROR FLAG

AP2203

Ordering Information

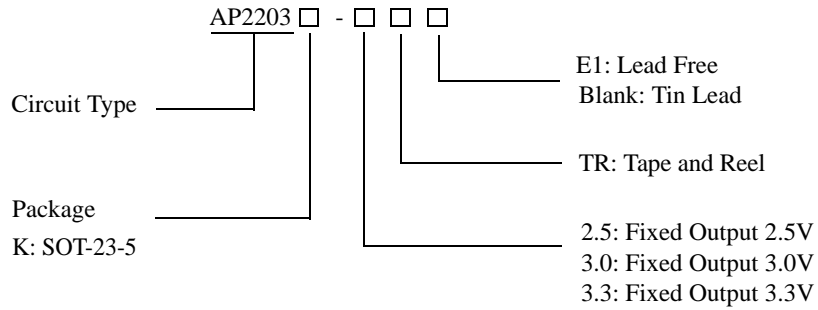

Package	Temperature Range	Part Number		Marking ID		Packing Type
		Tin Lead	Lead Free	Tin Lead	Lead Free	
SOT-23-5	-40 to 125°C	AP2203K-2.5TR	AP2203K-2.5TRE1	K3C	E3C	Tape & Reel
		AP2203K-3.0TR	AP2203K-3.0TRE1	K3F	E3F	Tape & Reel
		AP2203K-3.3TR	AP2203K-3.3TRE1	K3G	E3G	Tape & Reel

BCD Semiconductor's Pb-free products, as designated with "E1" suffix in the part number, are RoHS compliant.

**150mA RF ULDO REGULATOR WITH ERROR FLAG****AP2203****Absolute Maximum Ratings (Note 1)**

Parameter	Symbol	Value	Unit
Supply Input Voltage	V_{IN}	15	V
Enable Input Voltage	V_{EN}	15	V
Power Dissipation	P_D	Internally Limited (Thermal Protection)	W
Lead Temperature (Soldering, 5sec)	T_{LEAD}	260	°C
Storage Temperature	T_{STG}	-65 to 150	°C
ESD (Machine Model)		300	V
Thermal Resistance (No Heatsink)	θ_{JA}	200	°C/W

Note 1: Stresses greater than those listed under "Absolute Maximum Ratings" may cause permanent damage to the device. These are stress ratings only, and functional operation of the device at these or any other conditions beyond those indicated under "Recommended Operating Conditions" is not implied. Exposure to "Absolute Maximum Ratings" for extended periods may affect device reliability.

Recommended Operating Conditions

Parameter	Symbol	Min	Max	Unit
Supply Input Voltage	V_{IN}	2.5	13.2	V
Enable Input Voltage	V_{EN}	0	13.2	V
Operating Junction Temperature	T_J	-40	125	°C



150mA RF ULDO REGULATOR WITH ERROR FLAG AP2203

Electrical Characteristics

AP2203-2.5V Electrical Characteristics

V_{IN}=3.5V, I_{OUT}=100μA, C_{OUT}=2.2μF, V_{EN}≥2.0V, T_J=25°C, **Bold** typeface applies over -40°C<T_J<125°C (note 2), unless otherwise specified.

Parameter	Symbol	Conditions	Min	Typ	Max	Unit	
Output Voltage Accuracy	$\Delta V_{OUT}/V_{OUT}$	Variation from specified V _{OUT}	-1		1	%	
			-2		2		
Output Voltage Temperature Coefficient (Note 3)	$\Delta V_{OUT}/\Delta T$			120		μV/°C	
	$(\Delta V_{OUT}/V_{OUT})/\Delta T$			48		ppm/°C	
Line Regulation	V _{RLINE}	V _{IN} =3.5V to 13.2V		1.5	4.5	mV	
					12		
Load Regulation	V _{RLOAD}	I _{OUT} =0.1mA to 150mA (Note 4)		1	6	mV	
					15		
Dropout Voltage (Note 5)	V _{DROP}	I _{OUT} =100μA		15	50	mV	
					70		
			I _{OUT} =50mA		110		150
					230		
		I _{OUT} =100mA		140	250		
					300		
		I _{OUT} =150mA		165	275		
					350		
Quiescent Current	I _Q	V _{EN} ≤ 0.4V (shutdown)		0.01	1	μA	
		V _{EN} ≤ 0.18V (shutdown)			5		
Ground Pin Current (Note 6)	I _{GND}	V _{EN} ≥ 2.0V, I _{OUT} =100μA		100	150	μA	
					180		
			V _{EN} ≥ 2.0V, I _{OUT} =50mA		350		600
					800		
		V _{EN} ≥ 2.0V, I _{OUT} =100mA		600	1000		
					1500		
		V _{EN} ≥ 2.0V, I _{OUT} =150mA		1300	1900		
					2500		
Ripple Rejection	PSRR	frequency=100Hz, I _{OUT} =100μA		75		dB	
Current Limit	I _{LIMIT}	V _{OUT} =0V		450	650	mA	

**150mA RF ULDO REGULATOR WITH ERROR FLAG****AP2203****Electrical Characteristics (Continued)****AP2203-2.5V Electrical Characteristics**

$V_{IN}=3.5V$, $I_{OUT}=100\mu A$, $C_{OUT}=2.2\mu F$, $V_{EN}\geq 2.0V$, $T_J=25^\circ C$, **Bold** typeface applies over $-40^\circ C < T_J < 125^\circ C$ (note 2), unless otherwise specified.

Parameter	Symbol	Conditions	Min	Typ	Max	Unit
Enable Input Logic-low Voltage	V_{IL}	Regulator shutdown			0.4	V
					0.18	
Enable Input Logic-high Voltage	V_{IH}	Regulator enabled	2.0			V
Enable Input Logic-low Current	I_{IL}	$V_{IL} \leq 0.4V$		0.01	-1	μA
		$V_{IL} \leq 0.18V$			-2	
Enable Input Logic-high Current	I_{IH}	$V_{IL} \geq 2.0V$		5	20	μA
		$V_{IL} \geq 2.0V$			25	
Flag Threshold	V_{ERR}	Undervoltage condition (below nominal) (Note 7)	-10	-6	-2	%
Output Logic-low Voltage (Note 8)	V_{OL}	$I_{FL}=1mA$ Undervoltage condition		0.2	0.4	V
Flag Leakage Current	I_{FL}	Flag off, $V_{FLAG}=0V$ to 13.2V	-0.1	0.1	1	μA

Note 2: Specifications in bold type are limited to $-40^\circ C < T_J < 125^\circ C$. Limits over temperature are guaranteed by design, but not tested in production.

Note 3: Output voltage temperature coefficient is defined as the worst case voltage change divided by the total temperature range.

Note 4: Regulation is measured at constant junction temperature using low duty cycle pulse testing. Parts are tested for load regulation in the load range from 0.1mA to 150mA. Changes in output voltage due to heating effects are covered by the thermal regulation specification.

Note 5: Dropout voltage is defined as the input to output differential at which the output voltage drops 2% below its nominal value measured at 1V differential.

Note 6: Ground pin current is the regulator quiescent current plus pass transistor base current. The total current drawn from the supply is the sum of the load current plus the ground pin current.

Note 7: The error flag comparator includes 2.5% hysteresis.

Note 8: The FLAG pin will be enabled if EN pin voltage is high, and disabled if EN pin voltage is low.



150mA RF ULDO REGULATOR WITH ERROR FLAG AP2203

Electrical Characteristics (Continued)

AP2203-3.0V Electrical Characteristics

V_{IN}=4V, I_{OUT}=100μA, C_{OUT}=2.2μF, V_{EN}≥2.0V, T_J=25°C, **Bold** typeface applies over -40°C<T_J<125°C (note 2), unless otherwise specified.

Parameter	Symbol	Conditions	Min	Typ	Max	Unit
Output Voltage Accuracy	$\Delta V_{OUT}/V_{OUT}$	Variation from specified V _{OUT}	-1		1	%
			-2		2	
Output Voltage Temperature Coefficient (Note 3)	$\Delta V_{OUT}/\Delta T$			120		μV/°C
	$(\Delta V_{OUT}/V_{OUT})/\Delta T$			40		ppm/°C
Line Regulation	V _{RLINE}	V _{IN} =4V to 13.2V		1.5	4.5	mV
					12	
Load Regulation	V _{RLOAD}	I _{OUT} =0.1mA to 150mA (Note 4)		1	6	mV
					15	
Dropout Voltage (Note 5)	V _{DROP}	I _{OUT} =100μA		15	50	mV
					70	
		I _{OUT} =50mA		110	150	
					230	
		I _{OUT} =100mA		140	250	
					300	
		I _{OUT} =150mA		165	275	
					350	
Quiescent Current	I _Q	V _{EN} ≤ 0.4V (shutdown)		0.01	1	μA
		V _{EN} ≤ 0.18V (shutdown)			5	
Ground Pin Current (Note 6)	I _{GND}	V _{EN} ≥ 2.0V, I _{OUT} =100μA		100	150	μA
					180	
		V _{EN} ≥ 2.0V, I _{OUT} =50mA		350	600	
					800	
		V _{EN} ≥ 2.0V, I _{OUT} =100mA		600	1000	
					1500	
		V _{EN} ≥ 2.0V, I _{OUT} =150mA		1300	1900	
					2500	
Ripple Rejection	PSRR	frequency=100Hz, I _{OUT} =100μA		75		dB
Current Limit	I _{LIMIT}	V _{OUT} =0V		450	650	mA

**150mA RF ULDO REGULATOR WITH ERROR FLAG****AP2203****Electrical Characteristics (Continued)****AP2203-3.0V Electrical Characteristics**

$V_{IN}=4V$, $I_{OUT}=100\mu A$, $C_{OUT}=2.2\mu F$, $V_{EN}\geq 2.0V$, $T_J=25^\circ C$, **Bold** typeface applies over $-40^\circ C < T_J < 125^\circ C$ (note 2), unless otherwise specified.

Parameter	Symbol	Conditions	Min	Typ	Max	Unit
Enable Input Logic-low Voltage	V_{IL}	Regulator shutdown			0.4	V
					0.18	
Enable Input Logic-high Voltage	V_{IH}	Regulator enabled	2.0			V
Enable Input Logic-low Current	I_{IL}	$V_{IL}\leq 0.4V$		0.01	-1	μA
		$V_{IL}\leq 0.18V$			-2	
Enable Input Logic-high Current	I_{IH}	$V_{IL}\geq 2.0V$		5	20	μA
		$V_{IL}\geq 2.0V$			25	
Flag Threshold	V_{ERR}	Undervoltage condition (below nominal) (Note 7)	-10	-6	-2	%
Output Logic-low Voltage (Note 8)	V_{OL}	$I_{FL}=1mA$ Undervoltage condition		0.2	0.4	V
Flag Leakage Current	I_{FL}	Flag off, $V_{FLAG}=0V$ to 13.2V	-0.1	0.1	1	μA

Note 2: Specifications in bold type are limited to $-40^\circ C < T_J < 125^\circ C$. Limits over temperature are guaranteed by design, but not tested in production.

Note 3: Output voltage temperature coefficient is defined as the worst case voltage change divided by the total temperature range.

Note 4: Regulation is measured at constant junction temperature using low duty cycle pulse testing. Parts are tested for load regulation in the load range from 0.1mA to 150mA. Changes in output voltage due to heating effects are covered by the thermal regulation specification.

Note 5: Dropout voltage is defined as the input to output differential at which the output voltage drops 2% below its nominal value measured at 1V differential.

Note 6: Ground pin current is the regulator quiescent current plus pass transistor base current. The total current drawn from the supply is the sum of the load current plus the ground pin current.

Note 7: The error flag comparator includes 2.5% hysteresis.

Note 8: The FLAG pin will be enabled if EN pin voltage is high, and disabled if EN pin voltage is low.



150mA RF ULDO REGULATOR WITH ERROR FLAG

AP2203

Electrical Characteristics (Continued)

AP2203-3.3V Electrical Characteristics

V_{IN}=4.3V, I_{OUT}=100μA, C_{OUT}=2.2μF, V_{EN}≥2.0V, T_J=25°C, **Bold** typeface applies over -40°C<T_J<125°C (note 2), unless otherwise specified.

Parameter	Symbol	Conditions	Min	Typ	Max	Unit
Output Voltage Accuracy	$\Delta V_{OUT}/V_{OUT}$	Variation from specified V _{OUT}	-1		1	%
			-2		2	
Output Voltage Temperature Coefficient (Note 3)	$\Delta V_{OUT}/\Delta T$			120		μV/°C
	$(\Delta V_{OUT}/V_{OUT})/\Delta T$			36		ppm/°C
Line Regulation	V _{RLINE}	V _{IN} =4.3V to 13.2V		1.5	4.5	mV
					12	
Load Regulation	V _{RLOAD}	I _{OUT} =0.1mA to 150mA (Note 4)		1	6	mV
					15	
Dropout Voltage (Note 5)	V _{DROP}	I _{OUT} =100μA		15	50	mV
					70	
		I _{OUT} =50mA		110	150	
					230	
I _{OUT} =100mA		140	250			
			300			
I _{OUT} =150mA		165	275			
			350			
Quiescent Current	I _Q	V _{EN} ≤ 0.4V (shutdown)		0.01	1	μA
		V _{EN} ≤ 0.18V (shutdown)			5	
Ground Pin Current (Note 6)	I _{GND}	V _{EN} ≥ 2.0V, I _{OUT} =100μA		100	150	μA
					180	
		V _{EN} ≥ 2.0V, I _{OUT} =50mA		350	600	
					800	
V _{EN} ≥ 2.0V, I _{OUT} =100mA		600	1000			
			1500			
V _{EN} ≥ 2.0V, I _{OUT} =150mA		1300	1900			
			2500			
Ripple Rejection	PSRR	frequency=100Hz, I _{OUT} =100μA		75		dB
Current Limit	I _{LIMIT}	V _{OUT} =0V		450	650	mA



150mA RF ULDO REGULATOR WITH ERROR FLAG

AP2203

Electrical Characteristics (Continued)

AP2203-3.3V Electrical Characteristics

$V_{IN}=4.3V$, $I_{OUT}=100\mu A$, $C_{OUT}=2.2\mu F$, $V_{EN}\geq 2.0V$, $T_J=25^\circ C$, **Bold** typeface applies over $-40^\circ C < T_J < 125^\circ C$ (note 2), unless otherwise specified.

Parameter	Symbol	Conditions	Min	Typ	Max	Unit
Enable Input Logic-low Voltage	V_{IL}	Regulator shutdown			0.4	V
					0.18	
Enable Input Logic-high Voltage	V_{IH}	Regulator enabled	2.0			V
Enable Input Logic-low Current	I_{IL}	$V_{IL} \leq 0.4V$		0.01	-1	μA
		$V_{IL} \leq 0.18V$			-2	
Enable Input Logic-high Current	I_{IH}	$V_{IL} \geq 2.0V$		5	20	μA
		$V_{IL} \geq 2.0V$			25	
Flag Threshold	V_{ERR}	Undervoltage condition (below nominal) (Note 7)	-10	-6	-2	%
Output Logic-low Voltage (Note 8)	V_{OL}	$I_{FL}=1mA$ Undervoltage condition		0.2	0.4	V
Flag Leakage Current	I_{FL}	Flag off, $V_{FLAG}=0V$ to 13.2V	-0.1	0.1	1	μA

Note 2: Specifications in bold type are limited to $-40^\circ C < T_J < 125^\circ C$. Limits over temperature are guaranteed by design, but not tested in production.

Note 3: Output voltage temperature coefficient is defined as the worst case voltage change divided by the total temperature range.

Note 4: Regulation is measured at constant junction temperature using low duty cycle pulse testing. Parts are tested for load regulation in the load range from 0.1mA to 150mA. Changes in output voltage due to heating effects are covered by the thermal regulation specification.

Note 5: Dropout voltage is defined as the input to output differential at which the output voltage drops 2% below its nominal value measured at 1V differential.

Note 6: Ground pin current is the regulator quiescent current plus pass transistor base current. The total current drawn from the supply is the sum of the load current plus the ground pin current.

Note 7: The error flag comparator includes 2.5% hysteresis.

Note 8: The FLAG pin will be enabled if EN pin voltage is high, and disabled if EN pin voltage is low.



150mA RF ULDO REGULATOR WITH ERROR FLAG AP2203

Typical Performance Characteristics

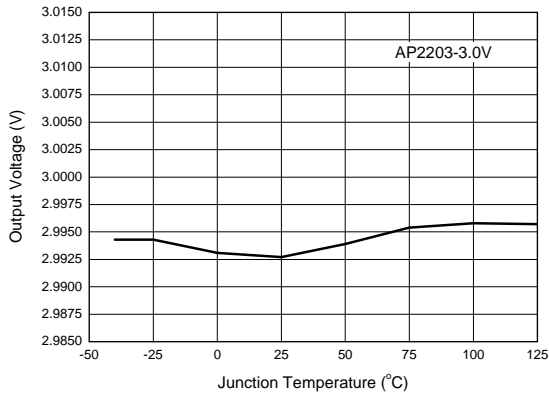

Figure 4. Output Voltage vs. Junction Temperature

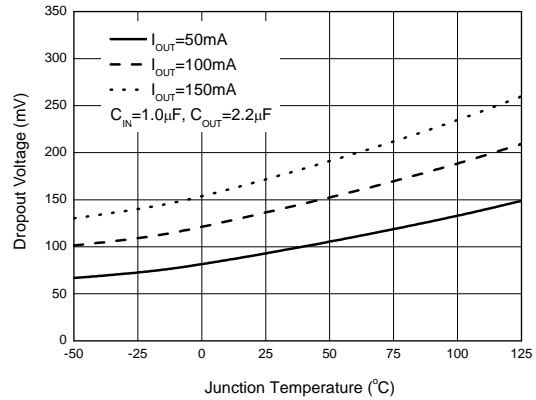

Figure 5. Dropout Voltage vs. Junction Temperature

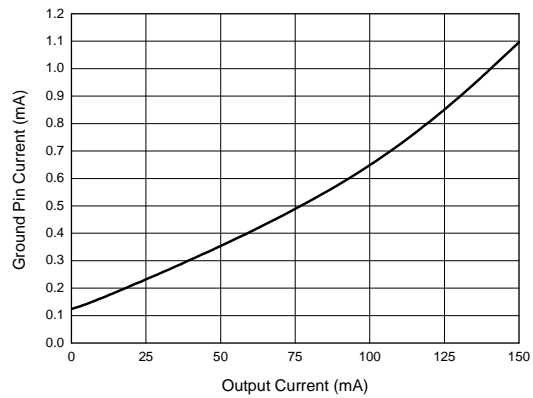

Figure 6. Ground Pin Current vs. Output Current

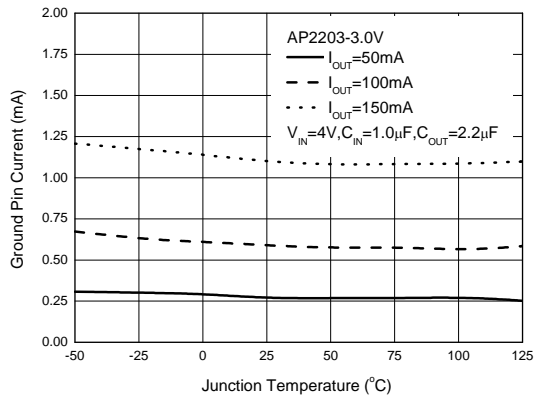

Figure 7. Ground Pin Current vs. Junction Temperature



150mA RF ULDO REGULATOR WITH ERROR FLAG

AP2203

Typical Performance Characteristics (Continued)

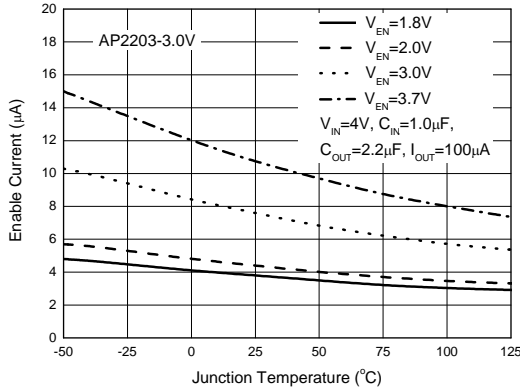

Figure 8. Enable Current vs. Junction Temperature

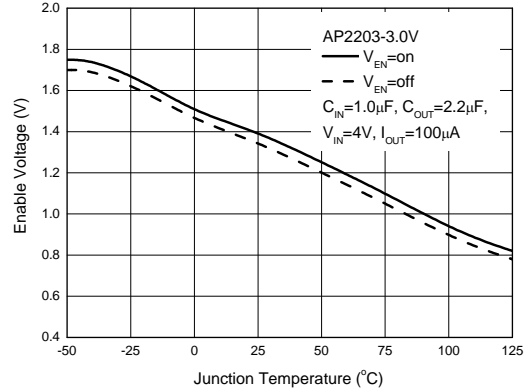

Figure 9. Enable Voltage vs. Junction Temperature

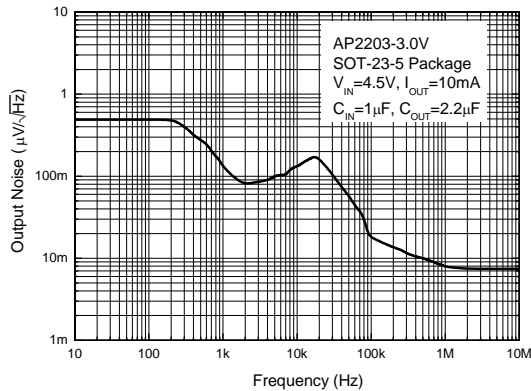

Figure 10. Output Noise vs. Frequency

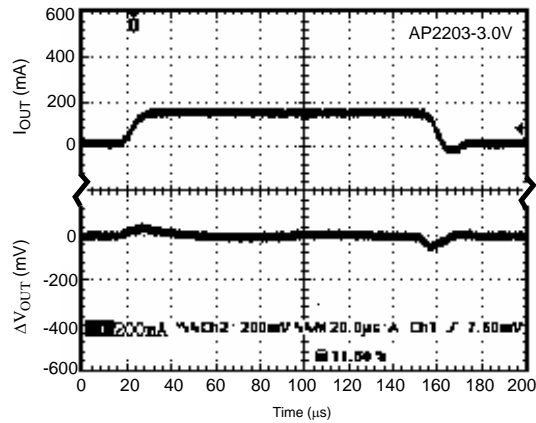

Figure 11. Load Transient
(Conditions: V_{IN}=4V, V_{EN}=2V, I_{OUT}=5mA to 200mA, C_{IN}=1µF, C_{OUT}=2.2µF)



150mA RF ULDO REGULATOR WITH ERROR FLAG

AP2203

Typical Performance Characteristics (Continued)

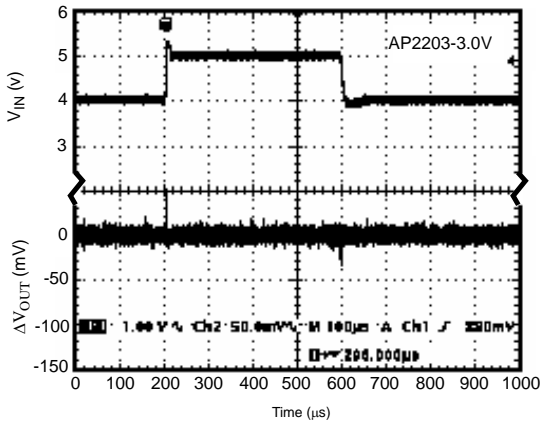

Figure 12. Line Transient
(Conditions: V_{IN} =4 to 5V, V_{EN} =2V, I_{OUT} =100 μ A
 C_{IN} =1 μ F, C_{OUT} =10 μ F)

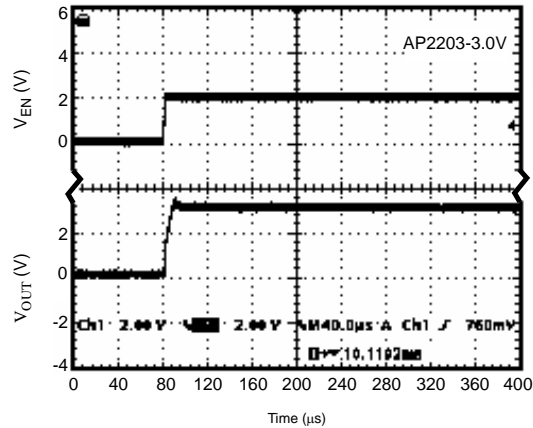

Figure 13. V_{EN} (on) vs. V_{OUT}
(Conditions: V_{EN} =0 to 2V, V_{IN} =4V, I_{OUT} =30mA,
 C_{IN} =1.0 μ F, C_{OUT} =2.2 μ F)

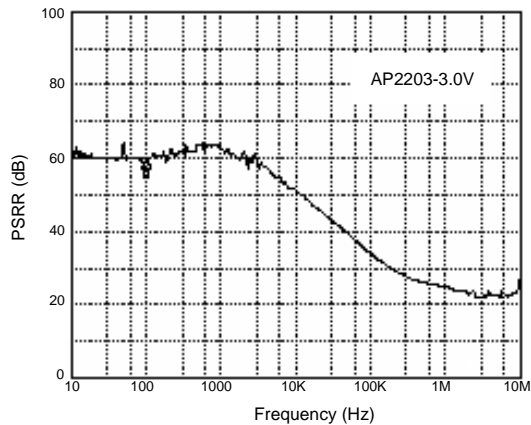

Figure 14. PSRR vs. Frequency
(Conditions: C_{IN} =1.0 μ F, C_{OUT} =2.2 μ F, V_{IN} =4V,
 I_{OUT} =100mA, V_{EN} =2V)

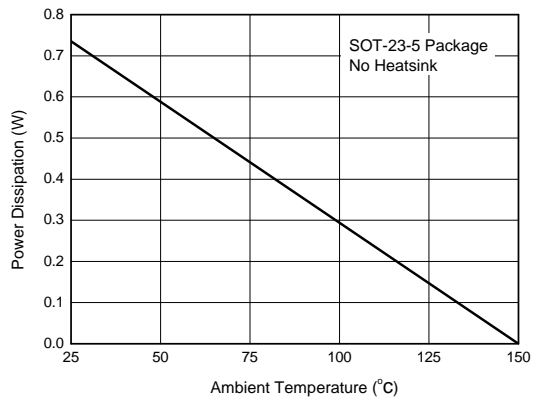

Figure 15. Power Dissipation vs. Ambient Temperature



150mA RF ULDO REGULATOR WITH ERROR FLAG

AP2203

Typical Performance Characteristics (Continued)

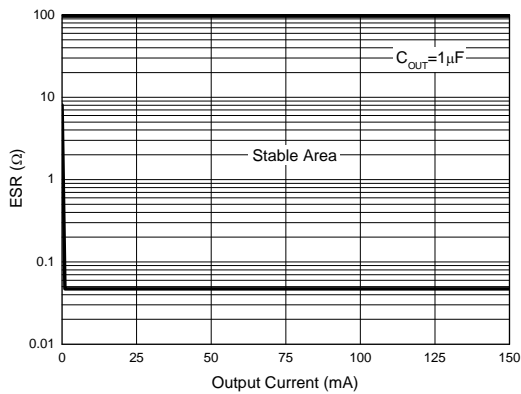

Figure 16. ESR vs. Output Current

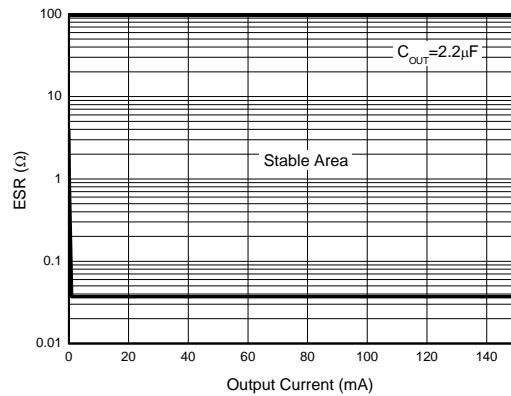

Figure 17. ESR vs. Output Current

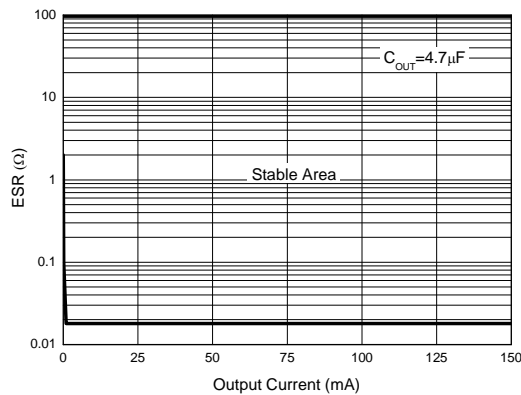

Figure 18. ESR vs. Output Current

**Typical Application**

Figure 19. Typical Application of AP2203

Note 9: Dropout voltage is 165mV when $T_A=25^\circ\text{C}$. In order to obtain a normal output voltage, $V_{OUT}+0.165\text{V}$ is the minimum input voltage which will result in a low PSRR, imposing a bad influence on the system. Therefore, the recommended input voltage is $V_{OUT}+0.5\text{V}$ to 13.2V. For the AP2203-3.0V version, its input voltage can be set from 3.5V ($V_{OUT}+0.5\text{V}$) to 13.2V.

**150mA RF ULDO REGULATOR WITH ERROR FLAG****AP2203****Application Information****Input Capacitor**

A 1 μ F minimum capacitor is recommended to be placed between V_{IN} and GND.

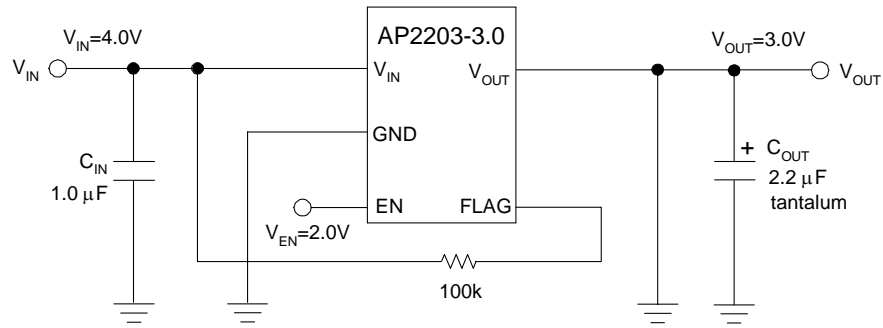
Output Capacitor

It is required to prevent oscillation. 1.0 μ F minimum is recommended. The output capacitor may be increased to improve transient response.

Power Dissipation

Thermal shutdown may take place if exceeding the maximum power dissipation in application. Under all possible operating conditions, the junction temperature must be within the range specified under absolute maximum ratings to avoid thermal shutdown.

To determine if the power dissipated in the regulator reaches the maximum power dissipation (see figure 15), using:

$$T_J = P_D * \theta_{JA} + T_A$$

$$P_D = (V_{IN} - V_{OUT}) * I_{OUT} + V_{IN} * I_{GND}$$

Where: $T_J \leq T_{J(max)}$, $T_{J(max)}$ is absolute maximum ratings for the junction temperature; $V_{IN} * I_{GND}$ can be ignored due to its small value.

$T_{J(max)}$ is 150°C while θ_{JA} is 200°C/W, no heatsink is required since the package alone will dissipate enough heat to satisfy these requirements unless the calculated value for power dissipation exceeds the limit.

Take 3.0V version as an example:

$$I_{OUT} = 150\text{mA}, T_A = 50^\circ\text{C}, V_{IN(Max)} \text{ is:}$$

$$(150^\circ\text{C} - 50^\circ\text{C}) / (0.15\text{A} * 200^\circ\text{C/W}) + 3.0\text{V} = 6.333\text{V}$$

Therefore, for good performance, please make sure that input voltage is less than 6.333V without heat-sink when $T_A = 50^\circ\text{C}$.



150mA RF ULDO REGULATOR WITH ERROR FLAG

AP2203

Mechanical Dimensions

SOT-23-5

Unit: mm(inch)

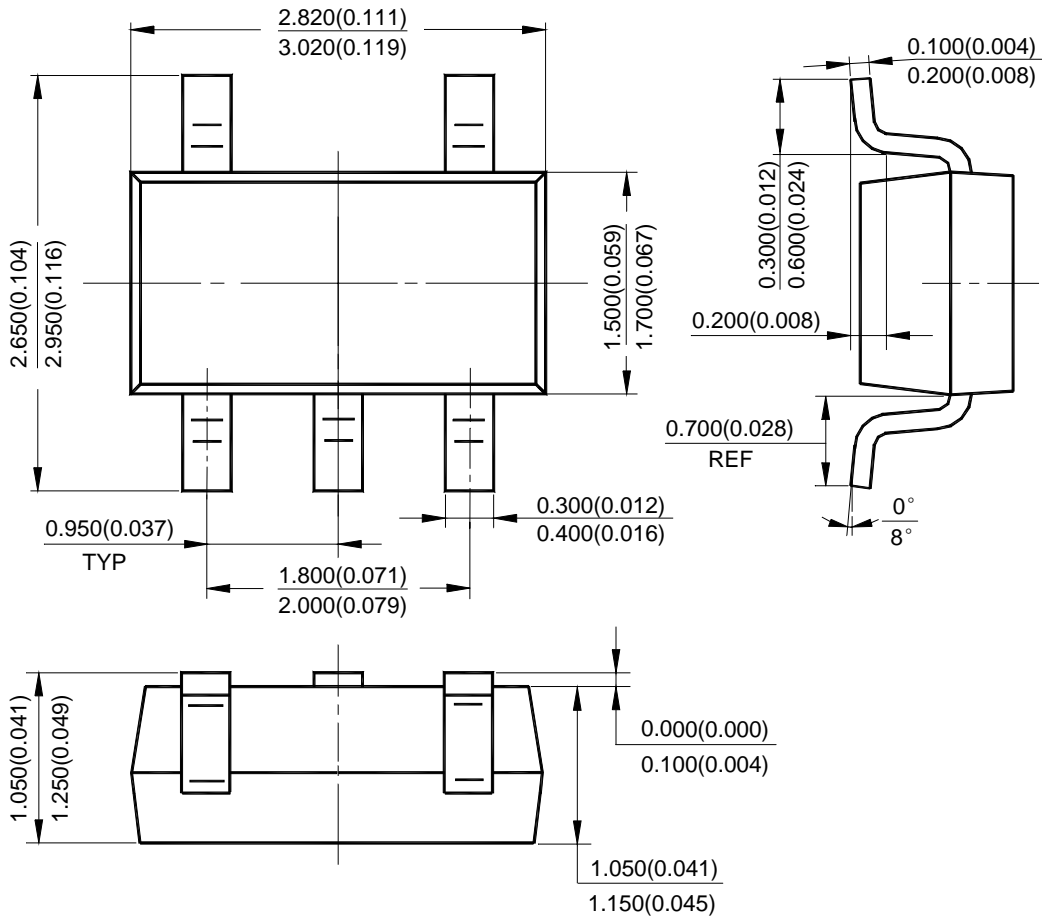



BCD Semiconductor Manufacturing Limited

<http://www.bcdsemi.com>

IMPORTANT NOTICE

BCD Semiconductor Manufacturing Limited reserves the right to make changes without further notice to any products or specifications herein. BCD Semiconductor Manufacturing Limited does not assume any responsibility for use of any its products for any particular purpose, nor does BCD Semiconductor Manufacturing Limited assume any liability arising out of the application or use of any its products or circuits. BCD Semiconductor Manufacturing Limited does not convey any license under its patent rights or other rights nor the rights of others.

MAIN SITE

BCD Semiconductor Manufacturing Limited
- Wafer Fab
Shanghai SIM-BCD Semiconductor Manufacturing Limited
800, Yi Shan Road, Shanghai 200233, China
Tel: +86-21-6485 1491, Fax: +86-21-5450 0008

BCD Semiconductor Manufacturing Limited
- IC Design Group
Advanced Analog Circuits (Shanghai) Corporation
8F, Zone B, 900, Yi Shan Road, Shanghai 200233, China
Tel: +86-21-6495 9539, Fax: +86-21-6485 9673

REGIONAL SALES OFFICE

Shenzhen Office
Shanghai SIM-BCD Semiconductor Manufacturing Co., Ltd. Shenzhen Office
Advanced Analog Circuits (Shanghai) Corporation Shenzhen Office
27B, Tower C, 2070, Middle Shen Nan Road, Shenzhen 518031, China
Tel: +86-755-8368 3987, Fax: +86-755-8368 3166

Taiwan Office
BCD Semiconductor (Taiwan) Company Limited
4F, 298-1, Rui Guang Road, Nei-Hu District, Taipei,
Taiwan
Tel: +886-2-2656 2808, Fax: +886-2-2656 2806

USA Office
BCD Semiconductor Corporation
3170 De La Cruz Blvd., Suite 105, Santa Clara,
CA 95054-2411, U.S.A
Tel: +1-408-988 6388, Fax: +1-408-988 6386