

CMOS 8-Bit Microcontroller

TMP86P820U/F

The TMP86P820 is a OTP type MCU which includes 8 Kbyte One-time PROM. It is a pin compatible with a mask ROM product of the TMP86C420/820. Writing the program to built-in PROM, the TMP86P820 operates as the same way as the TMP86C420/820. Using the Adapter socket, you can write and verify the data for the TMP86P820 with a general-purpose PROM programmer same as TC571000D/AD.

Product No.	OTP	RAM	Package	Adapter Socket
TMP86P820U	8 K × 8 bits	256 × 8 bits	P-LQFP64-1010-0.50	BM11162
TMP86P820F			P-QFP64-1414-0.80A	BM11163

P-LQFP64-1010-0.50

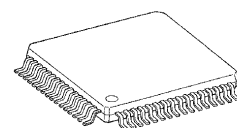

TMP86P820U

P-QFP64-1414-0.80A

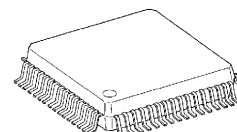

TMP86P820F

000707EBP1

- For a discussion of how the reliability of microcontrollers can be predicted, please refer to Section 1.3 of the chapter entitled Quality and Reliability Assurance / Handling Precautions.
- TOSHIBA is continually working to improve the quality and reliability of its products. Nevertheless, semiconductor devices in general can malfunction or fail due to their inherent electrical sensitivity and vulnerability to physical stress. It is the responsibility of the buyer, when utilizing TOSHIBA products, to comply with the standards of safety in making a safe design for the entire system, and to avoid situations in which a malfunction or failure of such TOSHIBA products could cause loss of human life, bodily injury or damage to property.
In developing your designs, please ensure that TOSHIBA products are used within specified operating ranges as set forth in the most recent TOSHIBA products specifications. Also, please keep in mind the precautions and conditions set forth in the "Handling Guide for Semiconductor Devices," or "TOSHIBA Semiconductor Reliability Handbook" etc..
- The TOSHIBA products listed in this document are intended for usage in general electronics applications (computer, personal equipment, office equipment, measuring equipment, industrial robotics, domestic appliances, etc.). These TOSHIBA products are neither intended nor warranted for usage in equipment that requires extraordinarily high quality and/or reliability or a malfunction or failure of which may cause loss of human life or bodily injury ("Unintended Usage"). Unintended Usage include atomic energy control instruments, airplane or spaceship instruments, transportation instruments, traffic signal instruments, combustion control instruments, medical instruments, all types of safety devices, etc.. Unintended Usage of TOSHIBA products listed in this document shall be made at the customer's own risk.
- The products described in this document are subject to the foreign exchange and foreign trade laws.
- The information contained herein is presented only as a guide for the applications of our products. No responsibility is assumed by TOSHIBA CORPORATION for any infringements of intellectual property or other rights of the third parties which may result from its use. No license is granted by implication or otherwise under any intellectual property or other rights of TOSHIBA CORPORATION or others.
- The information contained herein is subject to change without notice.

Pin Assignments (Top View)

P-LQFP64-1010-0.50
 P-QFP64-1414-0.80A

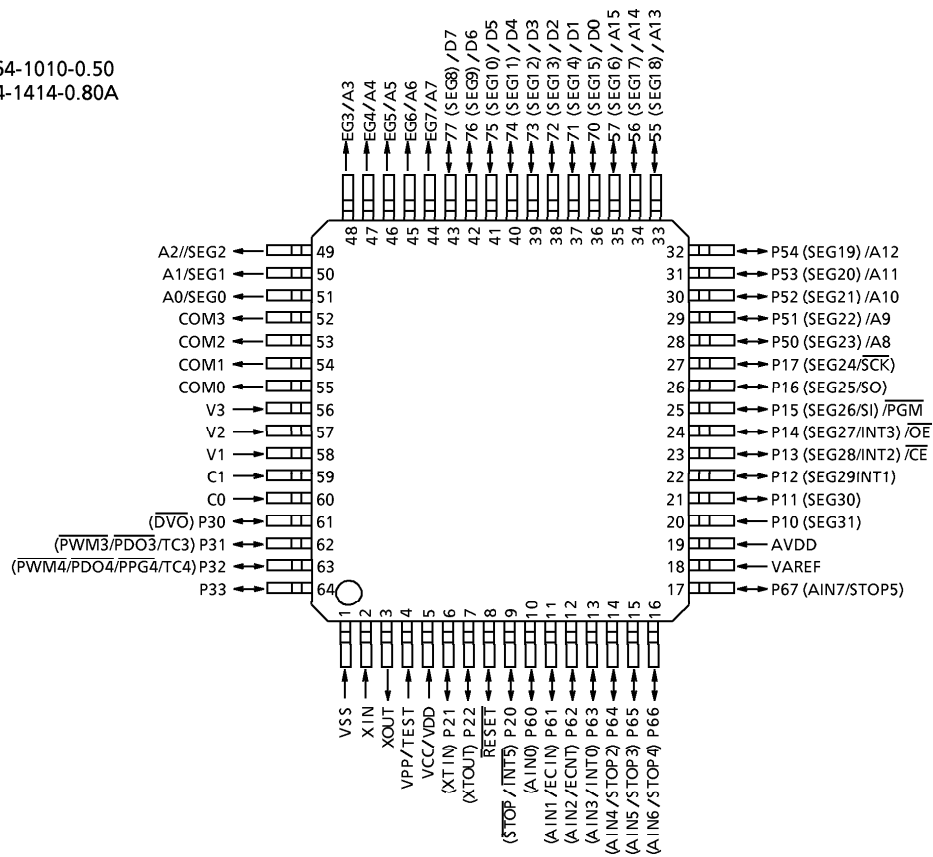

Pin Functions

The TMP86P820 has MCU mode and PROM mode.

(1) MCU mode

In the MCU mode, the TMP86P820 is a pin compatible with the TMP86C420/820 (Make sure to fix the TEST pin to low level).

(2) PROM mode

Pin Name	Input/Output	Functions	Pin Name (MCU mode)
A15 to A8 A7 to A0	Input	Input of Memory address for program	P57 to P50 SEG7 to SEG0
D7 to D0	I/O	Input/Output of Memory data for program	P77 to P70
\overline{CE}	Input	Chip enable	P13
\overline{OE}		Output enable	P14
PGM		Program control	P15
VPP	Power supply	+ 12.75 V/5 V (Power supply of program)	TEST
VCC, AVDD		+ 6.25 V/5 V	VDD, AVDD
GND, VAREF		0 V	VSS, VAREF
P11, P21 P10, P22, P20, P61	I/O	PROM mode setting pin. Fix to high.	
RESET		PROM mode setting pin. Fix to low.	
P64, P65, P67	Output	Output pin for PROM operation test. Open or release.	
P17, P16, P12 P66, P63 to P62, P60 P33 to P30 COM3 to COM0 V3 to V1 C1, C0	I/O	Open	
XIN	Input	Self oscillation with resonator (8 MHz).	
XOUT	Output		

Note: No pin is applied to A16 input.

Operation

This section describes the functions and basic operational blocks of TMP86P820.

The TMP86P820 has PROM in place of the mask ROM which is included in the TMP86C420/820.

The configuration and function are the same as the mask ROM products.

In addition, TMP86P820 operates as the single clock mode when releasing reset.

When using the dual clock mode, oscillate a low-frequency clock by SET. XTEN command at the beginning of program.

1. Operating Mode

The TMP86P820 has MCU mode and PROM mode.

1.1 MCU Mode

The MCU mode is set by fixing the TEST/VPP pin to the low level. (TEST/VPP pin cannot be used open because it has no built-in pull-down resistor).

1.1.1 Program Memory

The TMP86P820 has a 8 Kbyte built-in one time PROM (addresses E000 to FFFF_H in the MCU mode, addresses 0000 to 1FFF_H in the PROM mode).

When using TMP86P820 for evaluation of mask ROM products, the program is written in the program storing area shown in Figure 1-1.

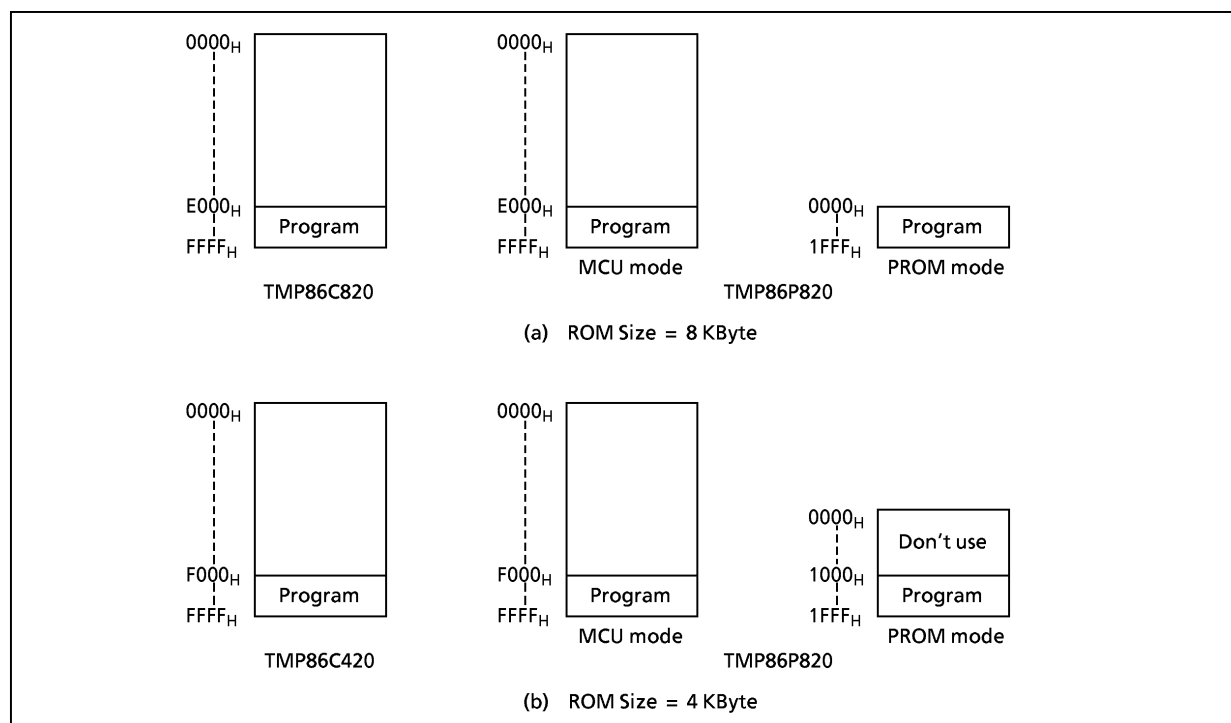

Figure 1-1. Program Memory Area

Note: The area that is not in use should be set data to FFH, or a general-purpose PROM programmer should be set only in the program memory area to access.

1.1.2 Data Memory

TMP86P820 has a built-in 256 byte Data memory (static RAM).

1.1.3 Input/Output Circuitry**(1) Control pins**

The control pins of the TMP86P820 are the same as those of the TMP86C420/820 except that the TEST pin does not have a built-in pull-down resistor.

(2) I/O ports

The I/O circuitries of TMP86P820 I/O ports are the same as the those of TMP86C420/820.

1.2 PROM Mode

The PROM mode is set by setting the $\overline{\text{RESET}}$ pin, the ports P11, P10, P22 to P20, P61 and TEST as shown in Figure 1-2. The programming and verification for the internal PROM is achieved by using a general-purpose PROM programmer with the adapter socket.

*Note: The high-speed program mode can be used. The setting is different according to the type of PROM programmer to use, refer to each description of PROM programmer.
The TMP86P820 does not support the electric signature mode, apply the ROM type of PROM programmer to TC571000D/AD.*

Always set the switch of Adapter socket to the N side when using TOSHIBA's Adapter socket.

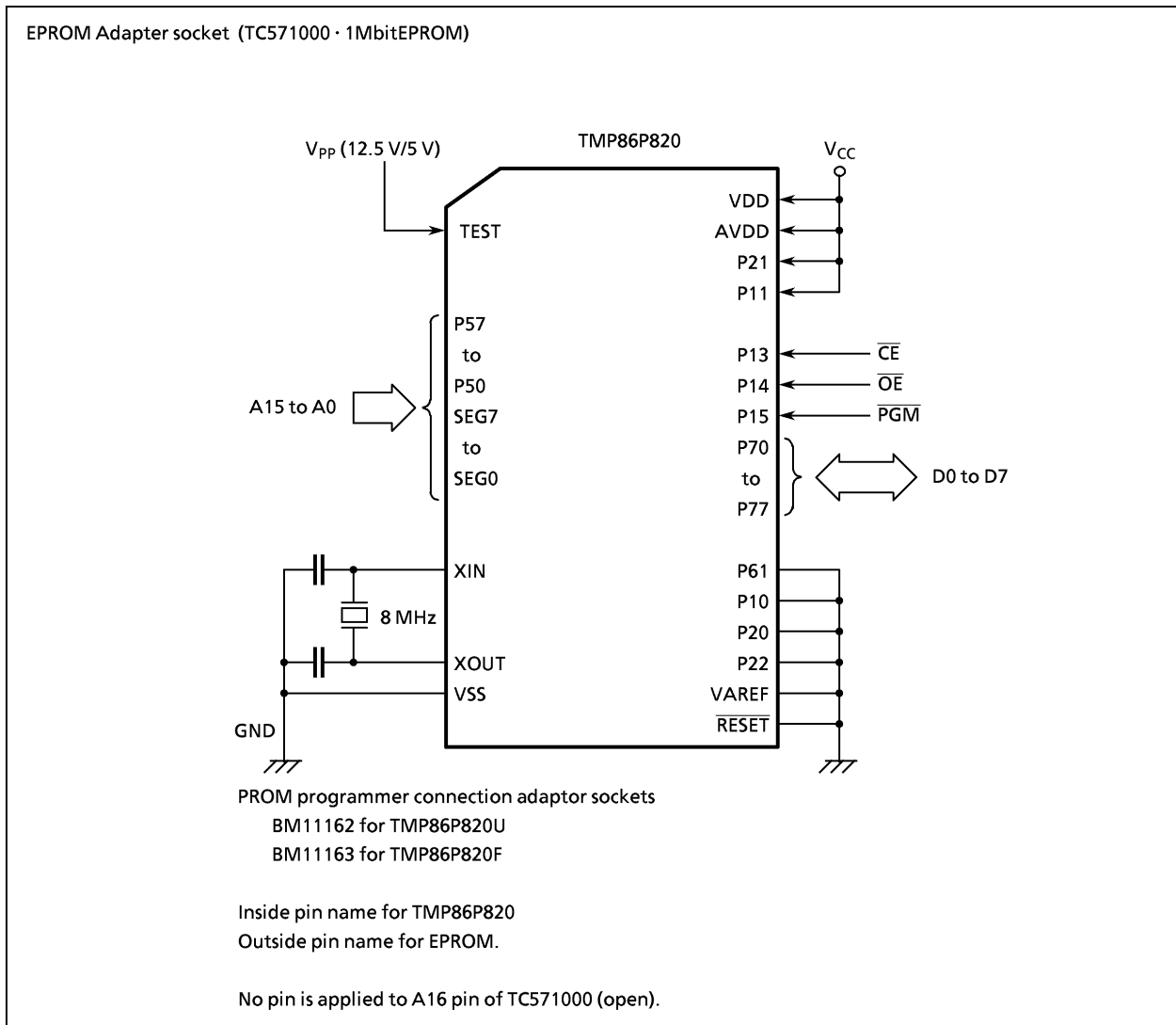

Figure 1-2. PROM Mode Setting

1.2.1 Programming Flowchart (High-speed program writing)

The high-speed programming mode is set by applying 12.75 V (programming voltage) to the V_{PP} pin when the V_{CC} is 6.25 V. After the address and data are fixed, the data in the address is written by applying 0.1ms of low level program pulse to \overline{PGM} pin. Then verify if the data is written.

If the programmed data is incorrect, another 0.1 ms pulse is applied to \overline{PGM} pin.

This programming procedure is repeated until correct data is read from the address (maximum of 25 times).

Subsequently, all data are programmed in all addresses.

When all data were written, verify all address under the condition of $V_{CC} = V_{PP} = 5$ V.

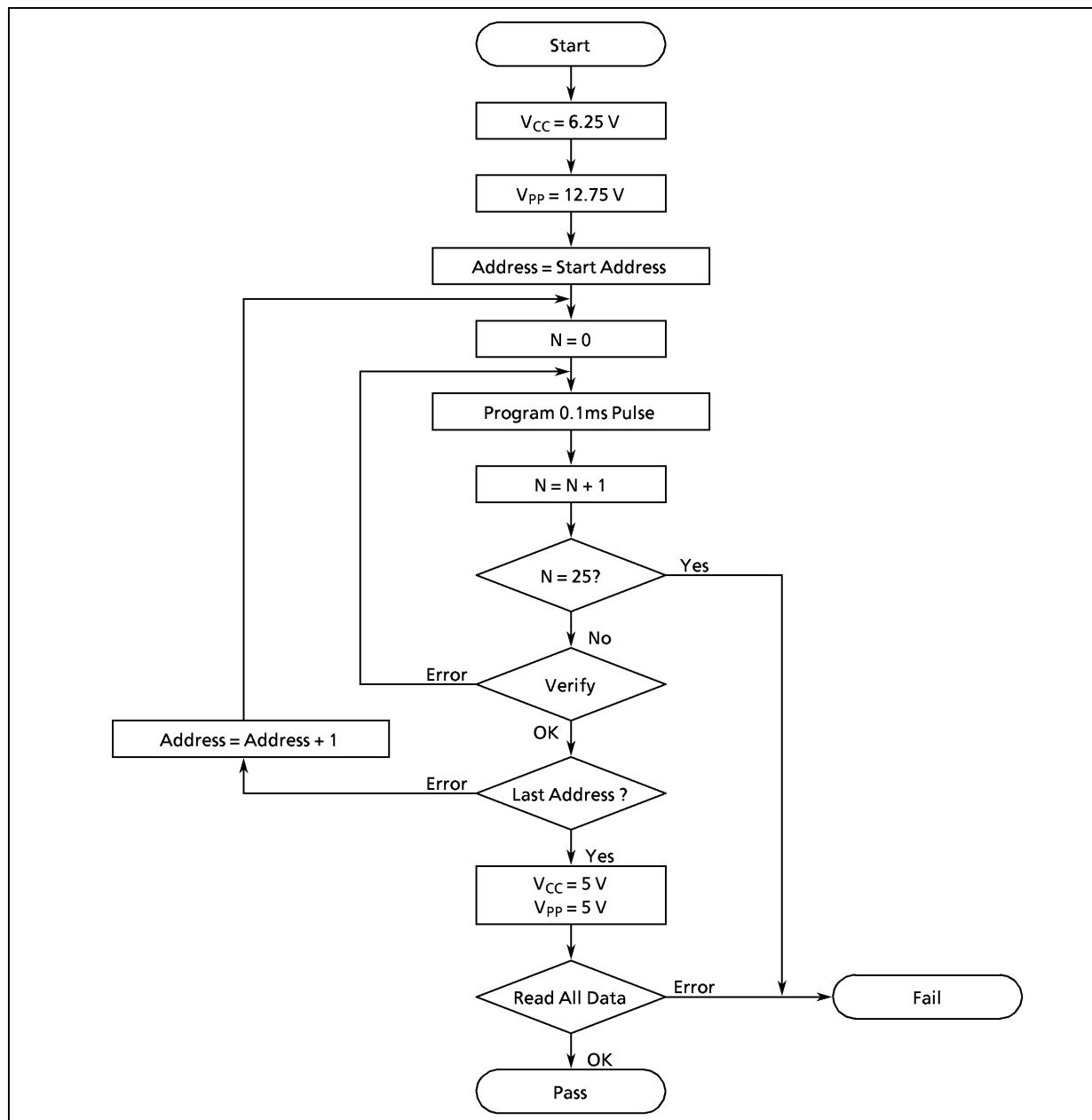

Figure 1-3. Programming Flowchart

1.2.2 Program Writing using a General-purpose PROM Programmer

(1) Recommended OTP Adapter

BM11162: for TMP86P820U
BM11163: for TMP86P820F

(2) Setting of OTP Adapter

Set the switch (SW1) to N side.

(3) Setting of PROM programmer

i) Set PROM type to TC571000D/AD.
VPP: 12.75 V (high-speed program writing)

ii) Data transmission (Note 1)

The PROM of TMP86P820 is located on different addresses; it depends on operating modes: MCU mode and PROM mode. When you write the data of ROM for mask ROM products, the data should be transferred from the address for MCU mode to that for PROM mode before writing operation is executed. For the applicable program areas of MCU mode and PROM mode are different, refer to Figure 1-1 Program Memory Area.

Example: In the block transfer (copy) mode, executed as below.

ROM capacity of 8 KB: Transferred address E000_H to FFFF_H to addresses 0000_H to 1FFF_H
ROM capacity of 4 KB: Transferred address F000_H to FFFF_H to addresses 1000_H to 1FFF_H

iii) Setting of the program address (Note 1)

Start address: 0000_H (When ROM capacity of 8 KB, start address is 0000_H.
When ROM capacity of 4 KB, start address is 1000_H.)

End address: 1FFF_H

(4) Writing program

Write and verify according to the above mentioned "Setting of PROM programmer."

Note 1: For the setting method, refer to each description of PROM programmer.

Make sure to set the data of address area that is not in used to FF_H.

Note 2: When setting MCU to the adapter or when setting the adapter to the PROM programmer, set the first pin of the adapter and that of PROM programmer socket matched. If the first pin is conversely set, MCU or adapter or programmer would be damaged.

Note 3: The TMP86P820 does not support the electric signature mode.

If PROM programmer uses the signature, the device would be damaged because of applying voltage of 12 ± 0.5 V to pin 9 (A9) of the address.

Do not use the signature.

Electrical Characteristics

Absolute Maximum Ratings	($V_{SS} = 0\text{ V}$)
--------------------------	---------------------------

Parameter	Symbol	Pins	Rating	Unit
Supply Voltage	V_{DD}		- 0.3 to 6.5	V
Program Voltage	V_{PP}	TEST/ V_{PP}	- 0.3 to 13.0	
Input Voltage	V_{IN}		- 0.3 to $V_{DD} + 0.3$	
Output Voltage	V_{OUT1}		- 0.3 to $V_{DD} + 0.3$	
Output Current (Per 1 pin)	I_{OUT1}	P3, P6 Port	- 1.8	mA
	I_{OUT2}	P1, P2, P5, P6, P7 Port	3.2	
	I_{OUT3}	P3 Port	30	
Output Current (Total)	ΣI_{OUT1}	P1, P2, P5, P6, P7 Port	60	
	ΣI_{OUT2}	P3 Port	80	
Power Dissipation [$T_{opr} = 85^\circ\text{C}$]	PD		350	mW
Soldering Temperature (time)	T_{sld}		260 (10 μ)	$^\circ\text{C}$
Storage Temperature	T_{stg}		- 55 to 125	
Operating Temperature	T_{opr}		- 40 to 85	

Note: The absolute maximum ratings are rated values which must not be exceeded during operation, even for an instant. Any one of the ratings must not be exceeded. If any absolute maximum rating is exceeded, a device may break down or its performance may be degraded, causing it to catch fire or explode resulting in injury to the user. Thus, when designing products which include this device, ensure that no absolute maximum rating value will ever be exceeded.

Recommended Operating Condition	($V_{SS} = 0\text{ V}$, $T_{opr} = -40\text{ to }85^{\circ}\text{C}$)
---------------------------------	--

Parameter	Symbol	Pins	Condition	Min	Max	Unit	
Supply Voltage	V_{DD}		$f_c = 16\text{ MHz}$	NORMAL1, 2 mode	4.5	5.5	V
				IDLE0, 1, 2 mode			
			$f_c = 8\text{ MHz}$	NORMAL1, 2 mode	2.7		
				IDLE0, 1, 2 mode			
			$f_c = 4.2\text{ MHz}$	NORMAL1, 2 mode	1.8		
IDLE0, 1, 2 mode							
$f_s = 32.768\text{ kHz}$	SLOW1, 2 mode	30.0					
	SLEEP0, 1, 2 mode						
			STOP mode				
Input high Level	V_{IH1}	Except Hysteresis input	$V_{DD} \geq 4.5\text{ V}$	$V_{DD} \times 0.70$	V_{DD}	V	
	V_{IH2}	Hysteresis input		$V_{DD} \times 0.75$			
	V_{IH3}			$V_{DD} < 4.5\text{ V}$			$V_{DD} \times 0.90$
Input low Level	V_{IL1}	Except Hysteresis input	$V_{DD} \geq 4.5\text{ V}$	0	$V_{DD} \times 0.30$	V	
	V_{IL2}	Hysteresis input			$V_{DD} \times 0.25$		
	V_{IL3}				$V_{DD} < 4.5\text{ V}$		$V_{DD} \times 0.10$
Clock Frequency	f_c	XIN, XOUT	$V_{DD} = 1.8\text{ to }5.5\text{ V}$	1.0	4.2	MHz	
			$V_{DD} = 2.7\text{ to }5.5\text{ V}$		8.0		
			$V_{DD} = 4.5\text{ to }5.5\text{ V}$		16.0		
	f_s	XTIN, XTOUT		30.0	34.0	kHz	

Note: The recommended operating conditions for a device are operating conditions under which it can be guaranteed that the device will operate as specified. If the device is used under operating conditions other than the recommended operating conditions (supply voltage, operating temperature range, specified AC/DC values etc.), malfunction may occur. Thus, when designing products which include this device, ensure that the recommended operating conditions for the device are always adhered to.

DC Characteristics

 $(V_{SS} = 0 \text{ V}, T_{opr} = -40 \text{ to } 85^\circ\text{C})$

Parameter	Symbol	Pins	Condition	Min	Typ.	Max	Unit
Hysteresis Voltage	V_{HS}	Hysteresis input		–	0.9	–	V
Input Current	I_{IN1}	TEST	$V_{DD} = 5.5 \text{ V}, V_{IN} = 5.5 \text{ V}/0 \text{ V}$	–	–	± 2	μA
	I_{IN2}	Sink Open Drain, Tri-state					
	I_{IN3}	$\overline{\text{RESET}}, \overline{\text{STOP}}$					
Input Resistance	R_{IN2}	$\overline{\text{RESET}}$ Pull-Up		100	220	450	$\text{k}\Omega$
Output Leakage Current	I_{LO}	Sink Open Drain, Tri-state	$V_{DD} = 5.5 \text{ V}, V_{OUT} = 5.5 \text{ V}/0 \text{ V}$	–	–	± 2	μA
Output High Voltage	V_{OH2}	C-MOS, Tri-st Port	$V_{DD} = 4.5 \text{ V}, I_{OH} = -0.7 \text{ mA}$	4.1	–	–	V
Output Low Voltage	V_{OL}	Except XOUT and P3 Port	$V_{DD} = 4.5 \text{ V}, I_{OL} = 1.6 \text{ mA}$	–	–	0.4	
Output Low Current	I_{OL}	High Current Port (P3 Port)	$V_{DD} = 4.5 \text{ V}, V_{OL} = 1.0 \text{ V}$	–	20	–	mA
Supply Current in NORMAL 1, 2 mode	V_{DD}		$V_{DD} = 5.5 \text{ V}$ $V_{IN} = 5.3/0.2 \text{ V}$ $f_c = 16 \text{ MHz}$ $f_s = 32.768 \text{ kHz}$	–	7.5	9	
Supply Current in IDLE 0, 1, 2 mode				–	5.5	6.5	
Supply Current in SLOW 1 mode			$V_{DD} = 3.0 \text{ V}$ $V_{IN} = 2.8 \text{ V}/0.2 \text{ V}$ $f_s = 32.768 \text{ kHz}$ LCD driver is not enable.	–	18	42	
Supply Current in SLEEP 1 mode				–	16	25	
Supply Current in SLEEP 0 mode				–	12	20	
Supply Current in STOP mode				$V_{DD} = 5.5 \text{ V}$ $V_{IN} = 5.3 \text{ V}/0.2 \text{ V}$	–	0.5	10

Note 1: Typical values show those at $T_{opr} = 25^\circ\text{C}$, $V_{DD} = 5 \text{ V}$

Note 2: Input current (I_{IN1} , I_{IN2}); The current through pull-up or pull-down resistor is not included.

Note 3: I_{DD} does not include I_{REF} current.

Note 4: The supply currents of SLOW 2 and SLEEP 2 modes are equivalent to IDLE 0, 1, 2.

AD Conversion Characteristics

(V_{SS} = 0.0 V, 4.5 V ≤ V_{DD} ≤ 5.5 V, Topr = -40 to 85°C)

Parameter	Symbol	Condition	Min	Typ.	Max	Unit
Analog Reference Voltage	V _{AREF}		A _{VDD} - 1.0	-	A _{VDD}	V
Power Supply Voltage of Analog Control Circuit	A _{VDD}		V _{DD}			
Analog Reference Voltage Range (Note 4)	ΔV _{AREF}		3.5	-	-	
Analog Input Voltage	V _{AIN}		V _{SS}	-	V _{AREF}	
Power Supply Current of Analog Reference Voltage	I _{REF}	V _{DD} = A _{VDD} = V _{AREF} = 5.5 V V _{SS} = 0.0 V	-	0.6	1.0	mA
Non linearity Error		V _{DD} = A _{VDD} = 5.0 V, V _{SS} = 0.0 V V _{AREF} = 5.0 V	-	-	± 1	LSB
Zero Point Error			-	-	± 1	
Full Scale Error			-	-	± 1	
Total Error			-	-	± 2	

(V_{SS} = 0.0 V, 2.7 V ≤ V_{DD} < 4.5 V, Topr = -40 to 85°C)

Parameter	Symbol	Condition	Min	Typ.	Max	Unit
Analog Reference Voltage	V _{AREF}		A _{VDD} - 1.0	-	A _{VDD}	V
Power Supply Voltage of Analog Control Circuit	A _{VDD}		V _{DD}			
Analog Reference Voltage Range (Note 4)	ΔV _{AREF}		2.5	-	-	
Analog Input Voltage	V _{AIN}		V _{SS}	-	V _{AREF}	
Power Supply Current of Analog Reference Voltage	I _{REF}	V _{DD} = A _{VDD} = V _{AREF} = 4.5 V V _{SS} = 0.0 V	-	0.5	0.8	mA
Non linearity Error		V _{DD} = A _{VDD} = 2.7 V, V _{SS} = 0.0 V V _{AREF} = 2.7 V	-	-	± 1	LSB
Zero Point Error			-	-	± 1	
Full Scale Error			-	-	± 1	
Total Error			-	-	± 2	

(V_{SS} = 0.0 V, 2.0 V ≤ V_{DD} < 2.7 V, Topr = -40 to 85°C) Note 5(V_{SS} = 0.0 V, 1.8 V ≤ V_{DD} < 2.0 V, Topr = -10 to 85°C) Note 5

Parameter	Symbol	Condition	Min	Typ.	Max	Unit
Analog Reference Voltage	V _{AREF}		A _{VDD} - 0.9	-	A _{VDD}	V
Power Supply Voltage of Analog Control Circuit	A _{VDD}		V _{DD}			
Analog Reference Voltage Range (Note 4)	ΔV _{AREF}	1.8 V ≤ V _{DD} < 2.0 V	1.8	-	-	
		2.0 V ≤ V _{DD} < 2.7 V	2.0	-	-	
Analog Input Voltage	V _{AIN}		V _{SS}	-	V _{AREF}	
Power Supply Current of Analog Reference Voltage	I _{REF}	V _{DD} = A _{VDD} = V _{AREF} = 2.7 V V _{SS} = 0.0 V	-	0.3	0.5	mA
Non linearity Error		V _{DD} = A _{VDD} = 1.8 V, V _{SS} = 0.0 V V _{AREF} = 1.8 V	-	-	± 2	LSB
Zero Point Error			-	-	± 2	
Full Scale Error			-	-	± 2	
Total Error			-	-	± 4	

Note 1: The total error includes all errors except a quantization error, and is defined as a maximum deviation from the ideal conversion line.

Note 2: Conversion time is different in recommended value by power supply voltage. About conversion time, please refer to "2.10.2 Register Framing".

Note 3: Please use input voltage to AIN input Pin in limit of V_{AREF} - V_{SS}. When voltage of range outside is input, conversion value becomes unsettled and gives affect to other channel conversion value.

Note 4: Analog Reference Voltage Range: ΔV_{AREF} = V_{AREF} - V_{SS}

Note 5: When AD is used with V_{DD} < 2.7 V, the guaranteed temperature range varies with the operating voltage.

AC Characteristics

 $(V_{SS} = 0\text{ V}, V_{DD} = 4.5\text{ to }5.5\text{ V}, T_{opr} = -40\text{ to }85^{\circ}\text{C})$

Parameter	Symbol	Condition	Min	Typ.	Max	Unit
Machine Cycle Time	t _{cy}	NORMAL 1, 2 mode	0.25	-	4	μs
		IDLE 1, 2 mode				
		SLOW 1, 2 mode	117.6	-	133.3	
		SLEEP 1, 2 mode				
High Level Clock Pulse Width	tw _{CH}	For external clock operation (XIN input)	-	31.25	-	ns
Low Level Clock Pulse Width	tw _{CL}	f _c = 16 MHz	-	31.25	-	ns
High Level Clock Pulse Width	tw _{CH}	For external clock operation (XTIN input)	-	15.26	-	μs
Low Level Clock Pulse Width	tw _{CL}	f _c = 32.768 kHz	-	15.26	-	μs

 $(V_{SS} = 0\text{ V}, V_{DD} = 2.7\text{ to }4.5\text{ V}, T_{opr} = -40\text{ to }85^{\circ}\text{C})$

Parameter	Symbol	Condition	Min	Typ.	Max	Unit
Machine Cycle Time	t _{cy}	NORMAL 1, 2 mode	0.5	-	4	μs
		IDLE 1, 2 mode				
		SLOW 1, 2 mode	117.6	-	133.3	
		SLEEP 1, 2 mode				
High Level Clock Pulse Width	tw _{CH}	For external clock operation (XIN input)	-	62.5	-	ns
Low Level Clock Pulse Width	tw _{CL}	f _c = 8 MHz	-	62.5	-	ns
High Level Clock Pulse Width	tw _{CH}	For external clock operation (XTIN input)	-	15.26	-	μs
Low Level Clock Pulse Width	tw _{CL}	f _c = 32.768 kHz	-	15.26	-	μs

 $(V_{SS} = 0\text{ V}, V_{DD} = 1.8\text{ to }2.7\text{ V}, T_{opr} = -40\text{ to }85^{\circ}\text{C})$

Parameter	Symbol	Condition	Min	Typ.	Max	Unit
Machine Cycle Time	t _{cy}	NORMAL 1, 2 mode	0.95	-	4	μs
		IDLE 1, 2 mode				
		SLOW 1, 2 mode	117.6	-	133.3	
		SLEEP 1, 2 mode				
High Level Clock Pulse Width	tw _{CH}	For external clock operation (XIN input)	-	119.05	-	ns
Low Level Clock Pulse Width	tw _{CL}	f _c = 4.2 MHz	-	119.05	-	ns
High Level Clock Pulse Width	tw _{CH}	For external clock operation (XTIN input)	-	15.26	-	μs
Low Level Clock Pulse Width	tw _{CL}	f _c = 32.768 kHz	-	15.26	-	μs

Timer Counter 1 input (ECIN) Characteristics

 $(V_{SS} = 0\text{ V}, T_{opr} = -40\text{ to }85^{\circ}\text{C})$

Parameter	Symbol	Condition	Min	Typ.	Max	Unit	
TC1 input (ECIN input)	t _{TC1}	Frequency measurement mode V _{DD} = 4.5 to 5.5 V	Single edge count	-	-	16	MHz
		Frequency measurement mode V _{DD} = 2.7 to 4.5 V	Single edge count	-	-	8	
		Frequency measurement mode V _{DD} = 1.8 to 2.7 V	Single edge count	-	-	4.2	

Recommended Oscillating Conditions - 1

 $(V_{SS} = 0\text{ V}, V_{DD} = 4.5\text{ to }5.5\text{ V}, T_{opr} = -40\text{ to }85^{\circ}\text{C})$

PARAMETER	Oscillator	Oscillation Frequency	Recommended Oscillator		Recommended Constant	
					C ₁	C ₂
High-frequency Oscillation	Ceramic Resonator	16 MHz	MURATA	CSA16.00MXZ040	10 pF	10 pF
		8 MHz	MURATA	CSA8.00MTZ	30 pF	30 pF
				CST8.00MTW	30 pF (built-in)	30 pF (built-in)
		4.19 MHz	MURATA	CSA4.19MG CST4.19MGW	30 pF 30 pF (built-in)	30 pF 30 pF (built-in)
Low-frequency Oscillation	Crystal Oscillator	32.768 kHz	SII	VT-200	6 pF	6 pF

Recommended Oscillating Conditions - 2

 $(V_{SS} = 0\text{ V}, V_{DD} = 2.7\text{ to }5.5\text{ V}, T_{opr} = -40\text{ to }85^{\circ}\text{C})$

PARAMETER	Oscillator	Oscillation Frequency	Recommended Oscillator		Recommended Constant	
					C ₁	C ₂
High-frequency Oscillation	Ceramic Resonator	8 MHz	MURATA	CSA8.00MTZ	30 pF	30 pF
				CST8.00MTW	30 pF (built-in)	30 pF (built-in)
		4.19 MHz	MURATA	CSA4.19MG CST4.19MGW	30 pF 30 pF (built-in)	30 pF 30 pF (built-in)

Recommended Oscillating Conditions - 3

 $(V_{SS} = 0\text{ V}, V_{DD} = 1.8\text{ to }5.5\text{ V}, T_{opr} = -40\text{ to }85^{\circ}\text{C})$

PARAMETER	Oscillator	Oscillation Frequency	Recommended Oscillator		Recommended Constant	
					C ₁	C ₂
High-frequency Oscillation	Ceramic Resonator	4.19 MHz	MURATA	CSA4.19MG CST4.19MGW	30 pF 30 pF (built-in)	30 pF 30 pF (built-in)

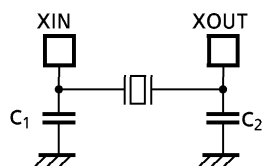

(1) High-frequency Oscillation

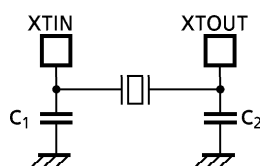

(2) Low-frequency Oscillation

Note 1: Use of a quartz oscillator for high-frequency oscillation is allowed only when V_{DD} is 2.7 V or higher. When V_{DD} is lower than 2.7 V, use a ceramic resonator.

Note 2: To ensure stable oscillation, the resonator position, load capacitance, etc. must be appropriate. Because these factors are greatly affected by board patterns, please be sure to evaluate operation on the board on which the device will actually be mounted.

Note 3: An electrical shield by metal shield plate on the surface of IC package is recommended in order to protect the device from the high electric field stress applied from CRT (Cathodic Ray Tube) for continuous reliable operation.

Note 4: The product numbers and specifications of the resonators by Murata Manufacturing Co., Ltd. are subject to change. For up-to-date information, please refer to the following URL;
<http://www.murata.co.jp/search/index.html>

DC Characteristics, AC Characteristics (PROM Mode) ($V_{SS} = 0\text{ V}$, $T_{opr} = -40\text{ to }85^{\circ}\text{C}$)

(1) Read operation in PROM mode

Parameter	Symbol	Conditions	Min	Typ.	Max	Unit
High level input voltage (TTL)	V_{IH4}		2.2	–	V_{CC}	V
Low level input voltage (TTL)	V_{IL4}		0	–	0.8	
Power supply	V_{CC}		4.75	5.0	5.25	
Power supply of program	V_{PP}					
Address access time	t_{ACC}	$V_{CC} = 5.0 \pm 0.25\text{ V}$	–	$1.5t_{cyc} + 300$	–	ns

Note: $t_{cyc} = 500\text{ ns}$ at 8 MHz

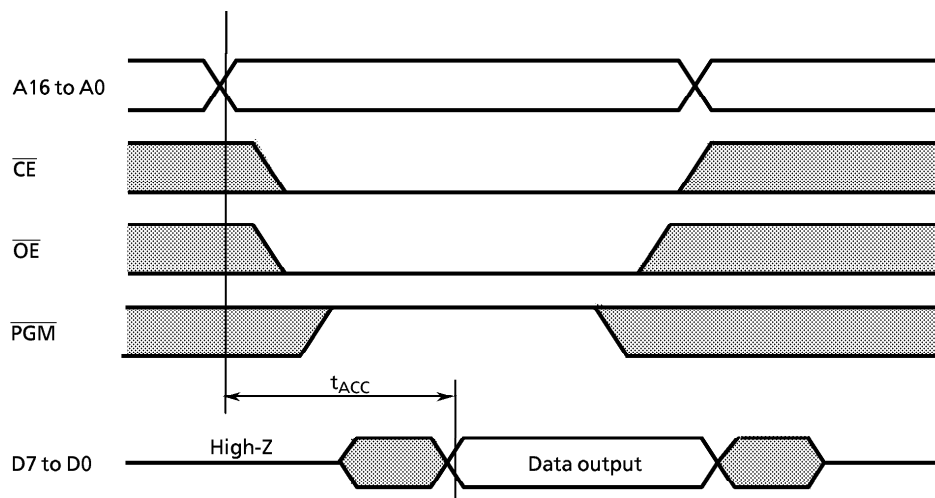

(2) Program operation (High-speed) ($T_{opr} = 25 \pm 5^\circ\text{C}$)

Parameter	Symbol	Conditions	Min	Typ.	Max	Unit
High level input voltage (TTL)	V_{IH4}		2.2	–	V_{CC}	V
Low level input voltage (TTL)	V_{IL4}		0	–	0.8	
Power supply	V_{CC}		6.0	6.25	6.5	
Power supply of program	V_{PP}		12.5	12.75	13.0	
Pulse width of initializing program	t_{PW}	$V_{CC} = 6.0\text{ V}$	0.095	0.1	0.105	ms

High-speed program writing

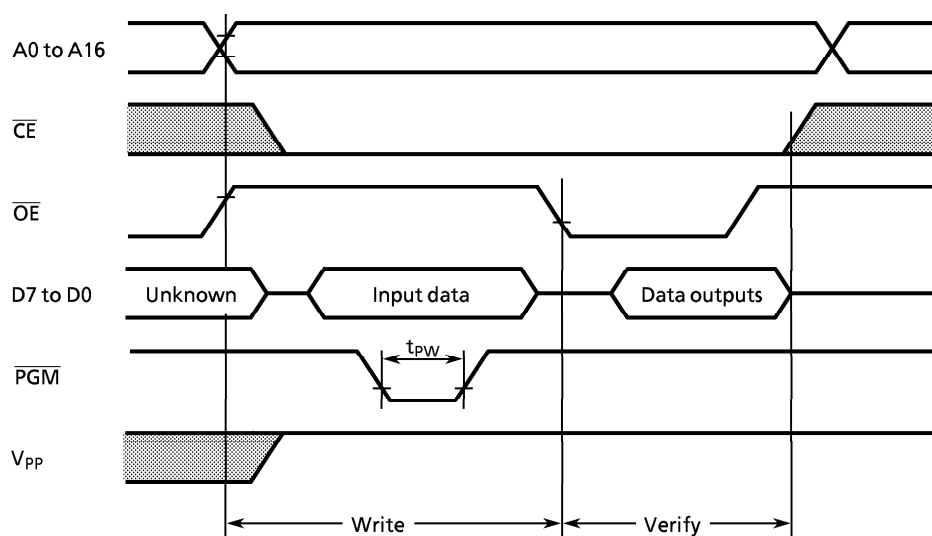

Note 1: The power supply of V_{PP} (12.75 V) must be set power-on at the same time or the later time for a power supply of V_{CC} and must be clear power-on at the same time or early time for a power supply of V_{CC} .

Note 2: The pulling up/down device on the condition of $V_{PP} = 12.75\text{ V} \pm 0.25\text{ V}$ causes a damage for the device. Do not pull up/down at programming.

Note 3: Use the recommended adapter (see 1.2.2 (1)) and mode (see 1.2.2 (3) i).

Using other than the above condition may cause the trouble of the writing.