

Part Number: SA08-13GWA

GREEN

Features

- 0.8 INCH DIGIT HEIGHT.
- LOW CURRENT OPERATION.
- EXCELLENT CHARACTER APPEARANCE.
- EASY MOUNTING ON P.C. BOARDS OR SOCKETS.
- I.C. COMPATIBLE.
- CATEGORIZED FOR LUMINOUS INTENSITY.
- MECHANICALLY RUGGED.
- STANDARD : GRAY FACE, WHITE SEGMENT.
- RoHS COMPLIANT.

Description

The Green source color devices are made with Gallium Phosphide Green Light Emitting Diode.

Package Dimensions & Internal Circuit Diagram

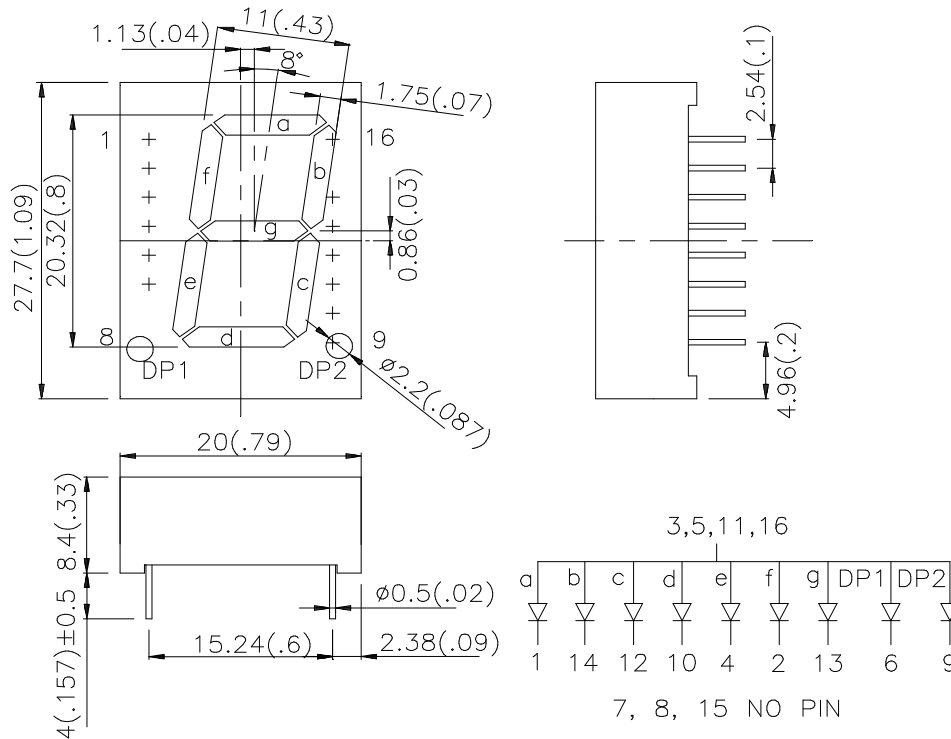

Notes:

1. All dimensions are in millimeters (inches), Tolerance is $\pm 0.25(0.01)$ unless otherwise noted.
2. Specifications are subject to change without notice.

Selection Guide

Part No.	Dice	Lens Type	Iv (ucd) [1] @ 10mA		Description
			Min.	Typ.	
SA08-13GWA	GREEN (GaP)	WHITE DIFFUSED	1900	10500	Common Anode, Rt. & Lt. Hand Decimal.

Note:

1. Luminous Intensity / Luminous Flux: +/-15%.

Electrical / Optical Characteristics at TA=25°C

Symbol	Parameter	Device	Typ.	Max.	Units	Test Conditions
λ_{peak}	Peak Wavelength	Green	565		nm	IF=20mA
λ_D [1]	Dominant Wavelength	Green	568		nm	IF=20mA
$\Delta\lambda/2$	Spectral Line Half-width	Green	30		nm	IF=20mA
C	Capacitance	Green	15		pF	VF=0V;f=1MHz
VF [2]	Forward Voltage	Green	2.2	2.5	V	IF=20mA
IR	Reverse Current	Green		10	uA	VR = 5V

Notes:

1. Wavelength: +/-1nm.

2. Forward Voltage: +/-0.1V.

Absolute Maximum Ratings at TA=25°C

Parameter	Green	Units
Power dissipation	105	mW
DC Forward Current	25	mA
Peak Forward Current [1]	140	mA
Reverse Voltage	5	V
Operating / Storage Temperature	-40°C To +85°C	
Lead Solder Temperature [2]	260°C For 3 Seconds	

Notes:

1. 1/10 Duty Cycle, 0.1ms Pulse Width.

2. 2mm below package base.

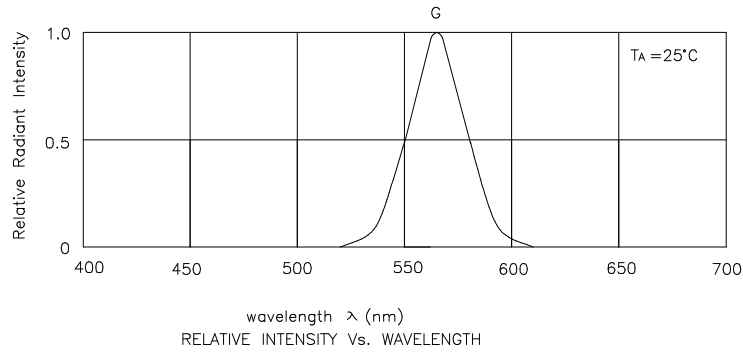

Green

SA08-13GWA

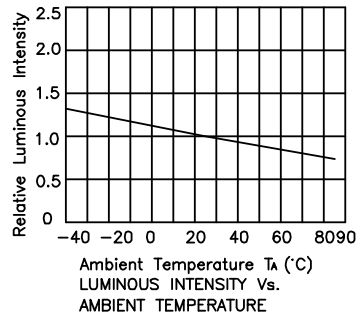
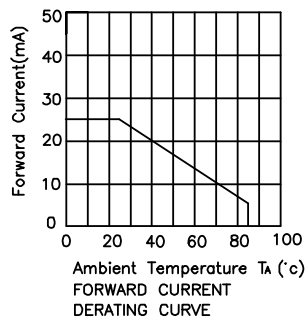
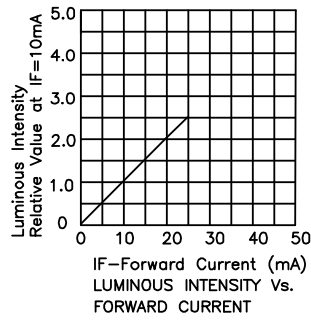
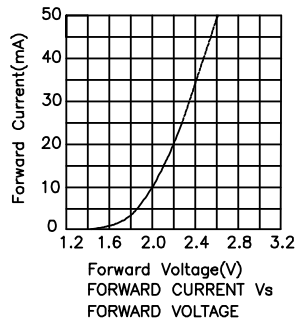

PACKING & LABEL SPECIFICATIONS

SA08-13GWA

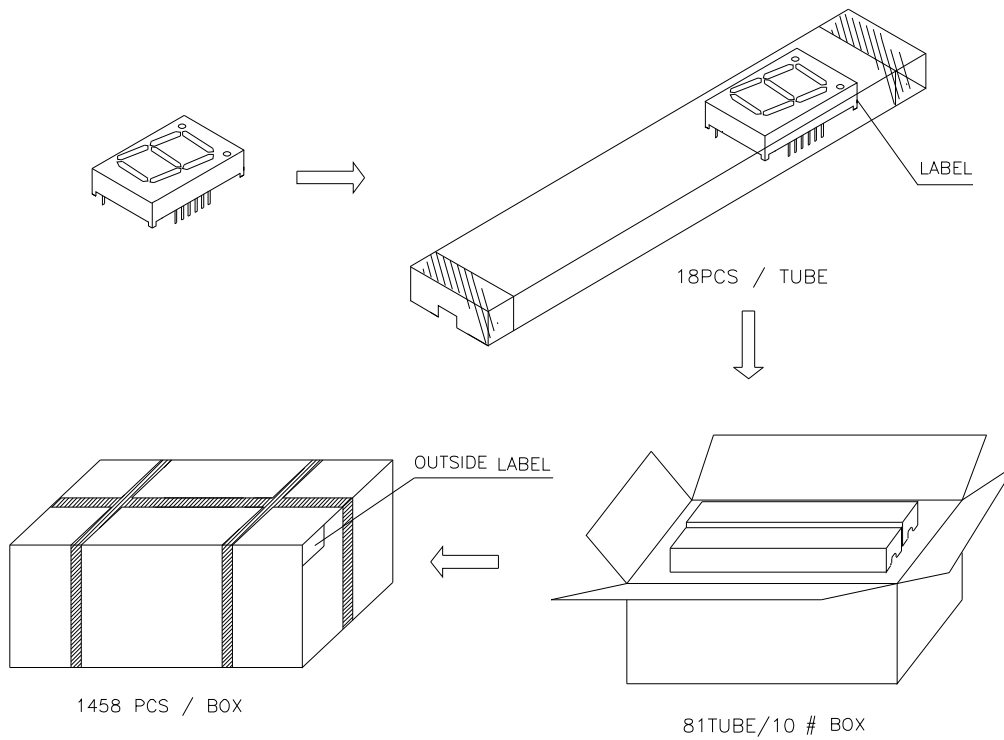

Inside LABEL Paste On The IC-tube

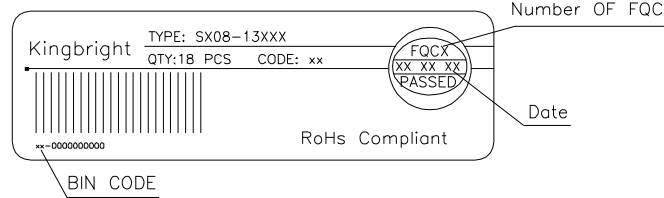

Outside LABEL Paste On The Box

